



# ±15kV ESD-Protected, 32Mbps, 3V/5V, Triple RS-422/RS-485 Receivers with Fault Detection

MAX3097E/MAX3098E

## General Description

The MAX3097E/MAX3098E feature three high-speed RS-485/RS-422 receivers with fault-detection circuitry and fault-status outputs. The receivers' inputs have fault thresholds that detect when the part is not in a valid state.

The MAX3097E/MAX3098E indicate when a receiver input is in an open-circuit condition, short-circuit condition, or outside the common-mode range. They also generate a fault indication when the differential input voltage goes below a preset threshold. See *Ordering Information* or the *Electrical Characteristics* for threshold values.

The fault circuitry includes a capacitor-programmable delay to ensure that there are no erroneous fault conditions even at slow edge rates. Each receiver is capable of accepting data at rates up to 32Mbps.

## Applications

- RS-485/RS-422 Receivers for Motor-Shaft Encoders
- High-Speed, Triple RS-485/RS-422 Receiver with Extended Electrostatic Discharge (ESD)
- Triple RS-485/RS-422 Receiver with Input Fault Indication
- Telecommunications
- Embedded Systems

## Typical Application Circuit

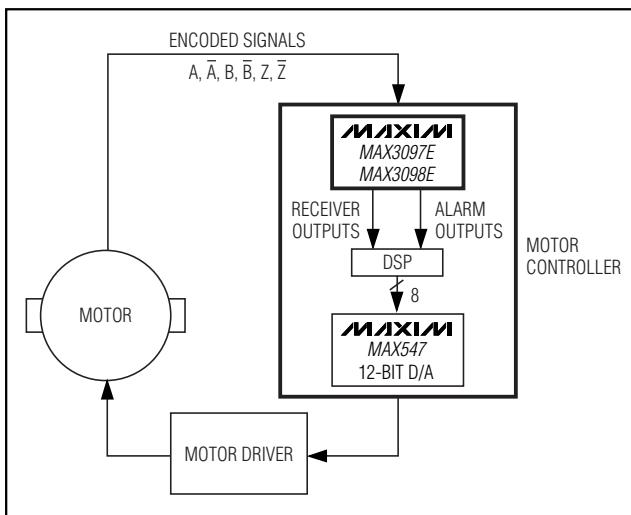

## Features

- ◆ Detects the Following RS-485 Faults:
  - Open-Circuit Condition
  - Short-Circuit Condition
  - Low Differential Voltage Signal
  - Common-Mode Range Violation
- ◆ ESD Protection
  - ±15kV—Human Body Model
  - ±15kV—IEC 1000-4-2, Air-Gap Discharge Method
  - ±8kV—IEC 1000-4-2, Contact Discharge Method
- ◆ Single +3V to +5.5V Operation
- ◆ -10V to +13.2V Extended Common-Mode Range
- ◆ Capacitor-Programmable Delay of Fault Indication Allows Error-Free Operation at Slow Data Rates
- ◆ Independent and Universal Fault Outputs
- ◆ 32Mbps Data Rate
- ◆ 16-Pin QSOP is 40% Smaller than Industry-Standard 26LS31/32 Solutions

## Ordering Information

PART	TEMP. RANGE	PIN-PACKAGE
MAX3097ECEE	0°C to +70°C	16 QSOP
MAX3097ECSE	0°C to +70°C	16 SO

Ordering Information continued at end of data sheet.

## Pin Configuration

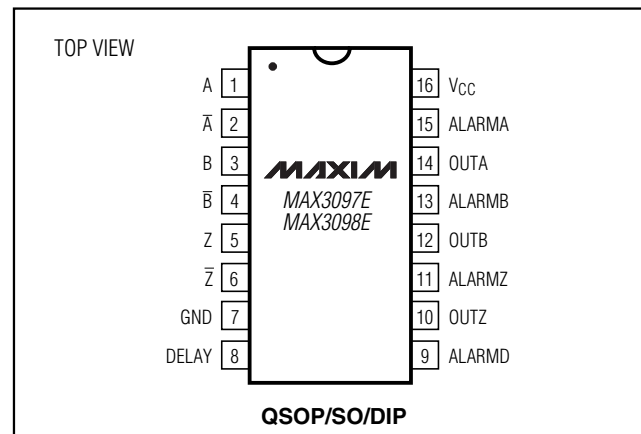

# ±15kV ESD-Protected, 32Mbps, 3V/5V, Triple RS-422/RS-485 Receivers with Fault Detection

## ABSOLUTE MAXIMUM RATINGS

Supply Voltage (V <sub>CC</sub> ).....	+7V	Operating Temperature Ranges	
Receiver Input Voltage (A, $\bar{A}$ , B, $\bar{B}$ , Z, $\bar{Z}$ ).....	±25V	MAX3097EC_E.....	0°C to +70°C
Output Voltage (OUT <sub>-</sub> , ALARM <sub>-</sub> ).....	-0.3V to (V <sub>CC</sub> + 0.3V)	MAX3098E_C_E.....	0°C to +70°C
DELAY.....	-0.3V to (V <sub>CC</sub> + 0.3V)	MAX3097E_E_E.....	-40°C to +85°C
Continuous Power Dissipation (T <sub>A</sub> = +70°C)		MAX3098E_E_E.....	-40°C to +85°C
16-Pin QSOP (derate 8.3mW/°C above +70°C).....	667mW	Storage Temperature Range.....	-65°C to +150°C
16-Pin SO (derate 8.7mW/°C above +70°C).....	696mW	Junction Temperature.....	+150°C
16-Pin Plastic DIP (derate 10.53mW/°C above +70°C).....	762mW	Lead Temperature (soldering, 10s).....	+300°C

Stresses beyond those listed under "Absolute Maximum Ratings" may cause permanent damage to the device. These are stress ratings only, and functional operation of the device at these or any other conditions beyond those indicated in the operational sections of the specifications is not implied. Exposure to absolute maximum rating conditions for extended periods may affect device reliability.

## ELECTRICAL CHARACTERISTICS

(V<sub>CC</sub> = +3V to +5.5V, T<sub>A</sub> = T<sub>MIN</sub> to T<sub>MAX</sub>, unless otherwise noted. Typical values are at V<sub>CC</sub> = +5V and T<sub>A</sub> = +25°C.)

PARAMETER	SYMBOL	CONDITIONS		MIN	TYP	MAX	UNITS
Supply Voltage Range	V <sub>CC</sub>			3		5.5	V
Supply Current	I <sub>CC</sub>	No load			3.1	4.0	mA
Receiver Differential Threshold Voltage (Note 1)	V <sub>TH</sub>	-10V ≤ V <sub>CM</sub> ≤ 13.2V		-200		+200	mV
Receiver Input Hysteresis	ΔV <sub>TH</sub>	-10V ≤ V <sub>CM</sub> ≤ 13.2V			40		mV
Output High Voltage	V <sub>OH</sub>	V <sub>CC</sub> = 4.75V, I <sub>O</sub> = -4mA, V <sub>ID</sub> = 200mV		V <sub>CC</sub> - 1.5			V
		V <sub>CC</sub> = 3.0V, I <sub>O</sub> = -1mA, V <sub>ID</sub> = 200mV		V <sub>CC</sub> - 1.0			
Output Low Voltage	V <sub>OL</sub>	V <sub>CC</sub> = 4.75V, I <sub>O</sub> = +4mA, V <sub>ID</sub> = -200mV				0.4	V
		V <sub>CC</sub> = 3.0V, I <sub>O</sub> = +1mA, V <sub>ID</sub> = -200mV				0.4	
Receiver Input Resistance	R <sub>IN</sub>	-10V ≤ V <sub>CM</sub> ≤ 13.2V		90		160	kΩ
Input Current (A, $\bar{A}$ , B, $\bar{B}$ , Z, $\bar{Z}$ )	I <sub>IN</sub>	V <sub>CC</sub> = 0 or 5.5V		V <sub>IN</sub> = 13.2V (Note 2)	0.07	0.14	mA
				V <sub>IN</sub> = -10V (Note 2)	-0.05	-0.11	
Output Short-Circuit Current	I <sub>OSR</sub>	0 ≤ V <sub>RO</sub> ≤ V <sub>CC</sub>				±105	mA
<b>FAULT DETECTION</b>							
MAX3097E Fault-Detection Receiver Differential Threshold Voltage (Note 3)	F <sub>DIFH</sub>	V <sub>CM</sub> = 0		High limit	275	475	mV
	F <sub>DIFL</sub>			Low limit	-475	-275	
MAX3098EA Fault-Detection Receiver Differential Threshold Voltage (Note 3)	F <sub>DIFH</sub>	V <sub>CM</sub> = 0		High limit	0.12	0.20	V
	F <sub>DIFL</sub>			Low limit	-0.20	-0.12	

# ±15kV ESD-Protected, 32Mbps, 3V/5V, Triple RS-422/RS-485 Receivers with Fault Detection

## ELECTRICAL CHARACTERISTICS (continued)

( $V_{CC} = +3V$  to  $+5.5V$ ,  $T_A = T_{MIN}$  to  $T_{MAX}$ , unless otherwise noted. Typical values are at  $V_{CC} = +5V$  and  $T_A = +25^\circ C$ .)

PARAMETER	SYMBOL	CONDITIONS	MIN	TYP	MAX	UNITS
MAX3098EB Fault-Detection Receiver Differential Threshold Voltage (Note 3)	$F_{DIFH}$	$V_{CM} = 0$	High limit	70	250	mV
	$F_{DIFL}$		Low limit	-250	-70	
Fault-Detection Common-Mode Voltage Range (Note 4)	$F_{CMH}$	High limit	13.2			V
	$F_{CML}$	Low limit			-10	
DELAY Current Source		$V_{CC} = 5V$ , $V_{DELAY} = 0$	9	10	11	$\mu A$
DELAY Threshold		$V_{CC} = 3V$	1.55	1.73	1.90	V
		$V_{CC} = 5V$	3.1	3.29	3.5	
<b>ESD PROTECTION</b>						
ESD Protection (A, $\bar{A}$ , B, $\bar{B}$ , Z, $\bar{Z}$ )		Human Body Model		±15		kV
		IEC1000-4-2 (Air-Gap Discharge)		±15		
		IEC1000-4-2 (Contact Discharge)		±8		

## SWITCHING CHARACTERISTICS

( $V_{CC} = +3V$  to  $+5.5V$ ,  $V_{ID} = \pm 3.0V$ ,  $T_A = T_{MIN}$  to  $T_{MAX}$ , unless otherwise noted. Typical values are at  $V_{CC} = +5V$  and  $T_A = +25^\circ C$ .)

PARAMETER	SYMBOL	CONDITIONS	MIN	TYP	MAX	UNITS
Propagation Delay from Input to Output	$t_{PLH}$ , $t_{PHL}$	$C_L = 15pF$ , Figures 1, 2	$V_{CC} = 4.5V$ to $5.5V$		75	ns
			$V_{CC} = 3.0V$ to $3.6V$		85	
Receiver Skew $ t_{PLH} - t_{PHL} $	$t_{SKEW}$	$C_L = 15pF$ , Figures 1, 2			±10	ns
Channel-to-Channel Propagation Delay Skew		$C_L = 15pF$ , Figures 1, 2			±10	ns
Maximum Data Rate	$f_{MAX}$	$C_L = 15pF$ , Figure 1	32			Mbps
<b>FAULT DETECTION</b>						
Differential Fault Propagation Delay to Output (Note 5)	$t_{DFLH}$	$C_L = 15pF$ , Figures 1, 3			15	$\mu s$
	$t_{DFHL}$				1.2	
Minimum Differential Slew Rate to Avoid False Alarm Output		MAX3097E (Note 6)	1.0			V/ $\mu s$
		MAX3098E (Note 7)	0.33			
Common-Mode Fault Propagation Delay to Output (Note 5)	$t_{CMFLH}$	$C_L = 15pF$ , Figures 1, 4			15	$\mu s$
	$t_{CMFHL}$				1.5	

**Note 1:**  $V_{CM}$  is the common-mode input voltage.  $V_{ID}$  is the differential input voltage.

**Note 2:**  $V_{IN}$  is the input voltage at pins A,  $\bar{A}$ , B,  $\bar{B}$ , Z,  $\bar{Z}$ .

**Note 3:** A differential terminating resistor is required for proper function of open-circuit fault detection (see *Applications Information*).

**Note 4:** See *Applications Information* for a discussion of the receiver common-mode voltage range and the operating conditions for fault indication.

**Note 5:** Applies to the individual channel immediate-fault outputs (ALARM<sub>n</sub>) and the general delayed-fault output (ALARMD) when there is no external capacitor at DELAY.

**Note 6:** Equivalent pulse test:  $1.3V / (t_{DFLH} - t_{DFHL}) \geq SR_D$ .

**Note 7:** Equivalent pulse test:  $0.62V / (t_{DFLH} - t_{DFHL}) \geq SR_D$ .

# **$\pm 15\text{kV}$ ESD-Protected, 32Mbps, 3V/5V, Triple RS-422/RS-485 Receivers with Fault Detection**

## **Typical Operating Characteristics**

(Typical values are at  $V_{CC} = +5\text{V}$  and  $T_A = +25^\circ\text{C}$ .)

**ALARM OUTPUT DELAY vs. CAPACITANCE**

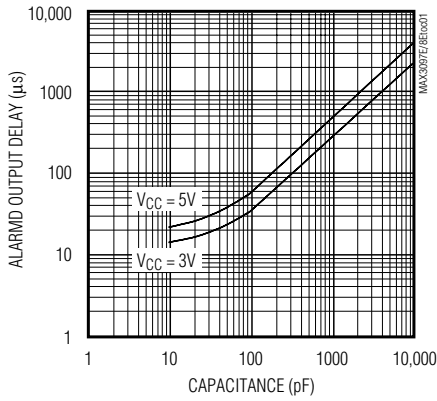

**RECEIVER PROPAGATION DELAY vs. TEMPERATURE**

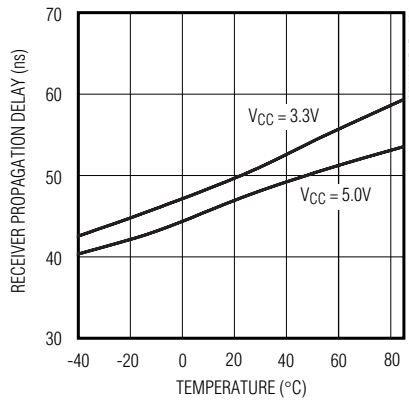

**SUPPLY CURRENT vs. TEMPERATURE**

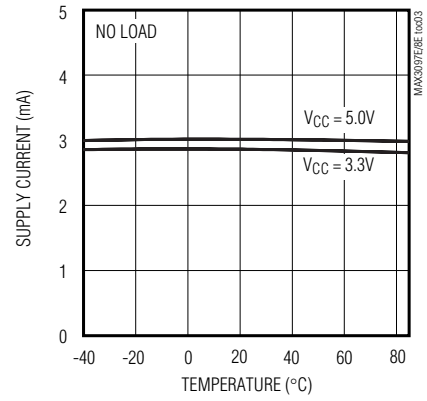

**RECEIVER OUTPUT LOW VOLTAGE vs. OUTPUT CURRENT**

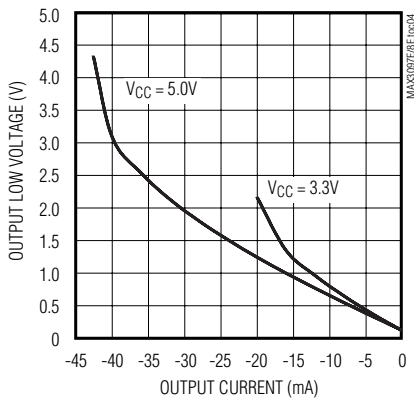

**RECEIVER OUTPUT HIGH VOLTAGE vs. OUTPUT CURRENT**

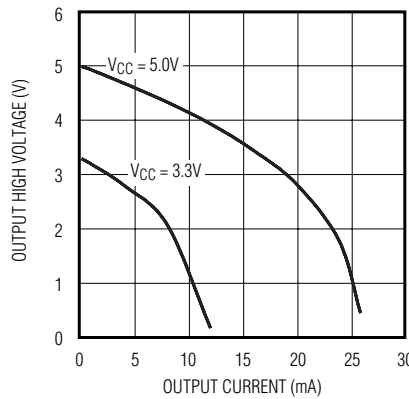

**DELAYED ALARM OUTPUT**

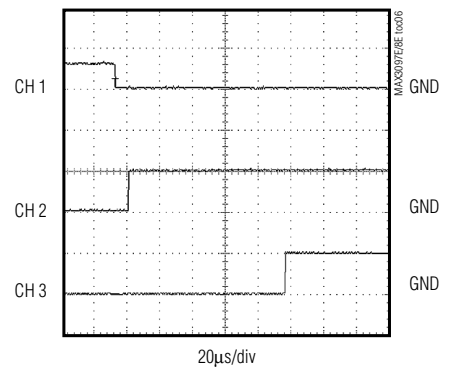

CH1:  $V_A$ , 5V/div  
 CH2:  $V_{ALARMA}$ , 5V/div  
 CH3:  $V_{ALARMD}$ , 5V/div  
 $V_{\bar{A}} = \text{GND}$ ,  $C_{DELAY} = 270\text{pF}$

# ±15kV ESD-Protected, 32Mbps, 3V/5V, Triple RS-422/RS-485 Receivers with Fault Detection

**MAX3097E/MAX3098E**

## Typical Operating Characteristics (continued)

(Typical values are at  $V_{CC} = +5V$  and  $T_A = +25^\circ C$ .)

**COMMON-MODE VOLTAGE FAULT  
(HIGH SIDE)**

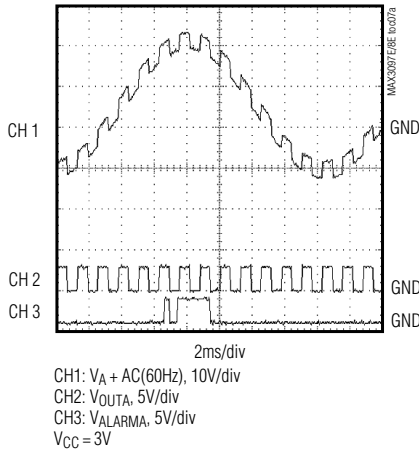

**COMMON-MODE VOLTAGE FAULT  
(LOW SIDE)**

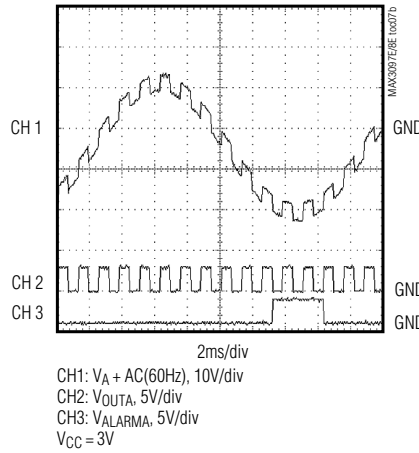

**MAX3097E  
LOW DIFFERENTIAL INPUT FAULT**

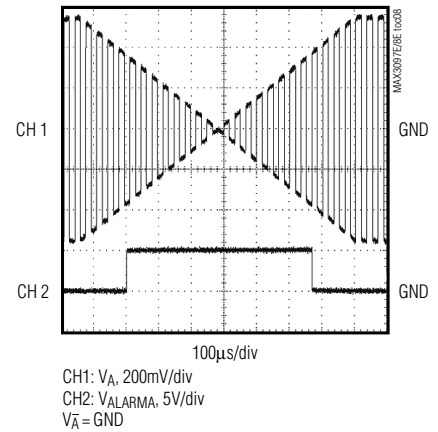

**SLEW-RATE FAULT**

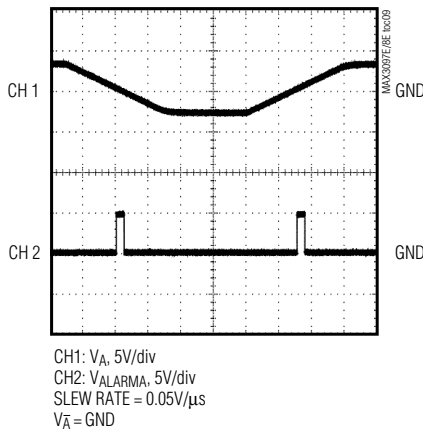

**FAULT-DETECTION RECEIVER DIFFERENTIAL  
THRESHOLD VOLTAGE SHIFT vs.  
COMMON-MODE VOLTAGE**

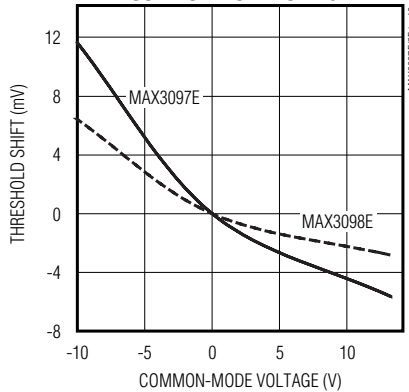

# **$\pm 15\text{kV}$ ESD-Protected, 32Mbps, 3V/5V, Triple RS-422/RS-485 Receivers with Fault Detection**

## **Pin Description**

<b>PIN</b>	<b>NAME</b>	<b>FUNCTION</b>
1	A	Noninverting Receiver A Input
2	$\bar{A}$	Inverting Receiver A Input
3	B	Noninverting Receiver B Input
4	$\bar{B}$	Inverting Receiver B Input
5	Z	Noninverting Receiver Z Input
6	$\bar{Z}$	Inverting Receiver Z Input
7	GND	Ground
8	DELAY	Programmable Delay Terminal. Connect a capacitor from DELAY to GND to set the ALARMD output delay time. To obtain a minimum delay, leave DELAY unconnected. See Capacitance vs. ALARMD Output Delay in the <i>Typical Operating Characteristics</i> .
9	ALARMD	Delayed Fault Output. This output is the logic OR of ALARMA, ALARMB, and ALARMZ. Place a capacitor from the DELAY pin to GND to set the delay (see <i>Setting Delay Time</i> ). A high logic level indicates a fault condition on at least one receiver input pair. A low level on this pin indicates no fault condition is present.
10	OUTZ	Z Receiver Output. If $V_Z - V_{\bar{Z}} \geq +200\text{mV}$ , OUTZ will be high. If $V_Z - V_{\bar{Z}} \leq -200\text{mV}$ , OUTZ will be low. If Z or $\bar{Z}$ exceeds the receiver's input common-mode voltage range, the ALARMZ output will be high and OUTZ will be indeterminate.
11	ALARMZ	Z Fault Output. When ALARMZ is high, OUTZ is indeterminate. Tables 1 and 2 show all the possible states for which an alarm is set.
12	OUTB	B Receiver Output. If $V_B - V_{\bar{B}} \geq +200\text{mV}$ , OUTB will be high. If $V_B - V_{\bar{B}} \leq -200\text{mV}$ , OUTB will be low. If B or $\bar{B}$ exceeds the input receiver's common-mode voltage range, the ALARMB output will be high and OUTB will be indeterminate.
13	ALARMB	B Fault Output. When ALARMB is high, OUTB is indeterminate. Tables 1 and 2 show all the possible states for which an alarm is set.
14	OUTA	A Receiver Output. If $V_A - V_{\bar{A}} \geq +200\text{mV}$ , OUTA will be high. If $V_A - V_{\bar{A}} \leq -200\text{mV}$ , OUTA will be low. If A or $\bar{A}$ exceeds the receiver's input common-mode voltage range, the ALARMA output will be high and OUTA will be indeterminate.
15	ALARMA	A Fault Output. When ALARMA is high, OUTA is indeterminate. Tables 1 and 2 show all the possible states for which an alarm is set.
16	VCC	Power Supply

# ±15kV ESD-Protected, 32Mbps, 3V/5V, Triple RS-422/RS-485 Receivers with Fault Detection

## Detailed Description

The MAX3097E/MAX3098E feature high-speed, triple RS-485/RS-422 receivers with fault-detection circuitry and fault-status outputs. The fault outputs are active push-pull, requiring no pull-up resistors. The fault circuitry includes a capacitor-programmable delayed FAULT\_ output to ensure that there are no erroneous fault conditions even at slow edge rates (see *Delayed Fault Output*). The receivers operate at data rates up to 32Mbps.

The MAX3097E/MAX3098E are designed for motor-shaft encoders with standard A, B, and Z outputs (see *Using the MAX3097E/MAX3098E as Shaft Encoder Receivers*). The devices provide an alarm for open-circuit conditions, short-circuit conditions, data nearing the minimum differential threshold conditions, data below the minimum threshold conditions, and receiver inputs outside the input common-mode range. Tables 1 and 2 are functional tables for each receiver.

## Test Circuits and Waveforms

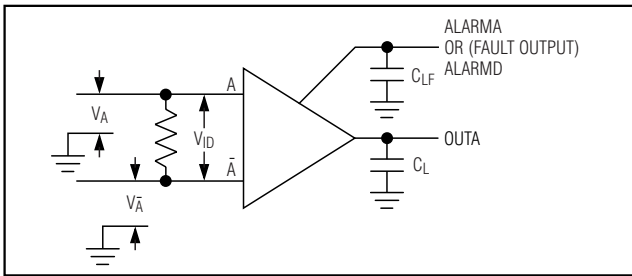

Figure 1. Typical Receiver Test Circuit

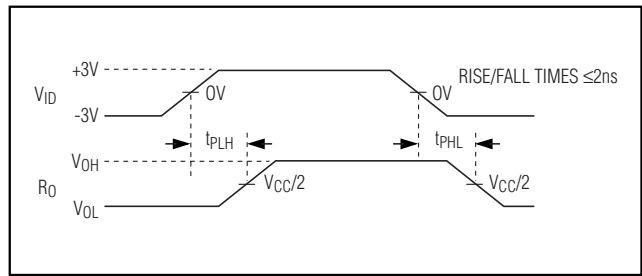

Figure 2. Propagation Delay

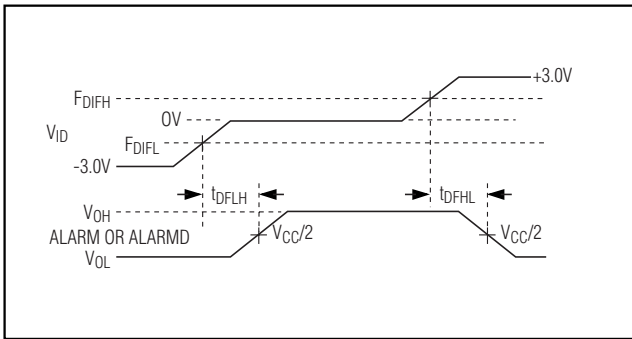

Figure 3. Fault-Detection Timing

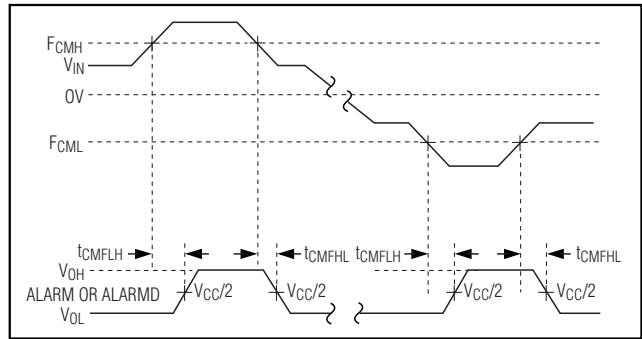

Figure 4. Common-Mode Fault Propagation Delay

# **$\pm 15\text{kV}$ ESD-Protected, 32Mbps, 3V/5V, Triple RS-422/RS-485 Receivers with Fault Detection**

**Table 1. MAX3097E Alarm Function Table (Each Receiver)**

INPUTS		OUTPUTS			FAULT CONDITION
$V_{ID}$ (DIFFERENTIAL INPUT VOLTAGE)	COMMON-MODE VOLTAGE	OUT_	ALARM_	ALARMD $t \geq \text{DELAY}$ (NOTE 1)	
$\geq 0.475\text{V}$	$\leq 13.2\text{V}$ and $\geq -10\text{V}$	1	0	0	Normal Operation
$< 0.475\text{V}$ and $\geq 0.275\text{V}$		1	Indeterminate	Indeterminate	Indeterminate
$< 0.275\text{V}$ and $\geq 0.2\text{V}$		1	1	1	Low Input Differential Voltage
$\leq 0.2\text{V}$ and $\geq -0.2\text{V}$		Indeterminate (Note 2)	1	1	Low Input Differential Voltage
$\leq -0.2\text{V}$ and $> -0.275\text{V}$		0	1	1	Low Input Differential Voltage
$\leq -0.275\text{V}$ and $> -0.475\text{V}$		0	Indeterminate	Indeterminate	Indeterminate
$\leq -0.475\text{V}$		0	0	0	
X	$< -10\text{V}$ or $> +13.2\text{V}$	Indeterminate (Note 3)	1	1	Outside Common-Mode Voltage Range

X = Don't care

**Note 1:** ALARMD indicates fault for any receiver.

**Note 2:** Receiver output may oscillate with this differential input condition.

**Note 3:** See *Applications Information* for conditions leading to input range fault condition.

**Table 2. MAX3098EA Alarm Function Table (Each Receiver)**

INPUTS		OUTPUTS			FAULT CONDITION
$V_{ID}$ (DIFFERENTIAL INPUT VOLTAGE)	COMMON-MODE VOLTAGE	OUT_	ALARM_	ALARMD $t \geq \text{DELAY}$ (NOTE 1)	
$\geq 0.2\text{V}$	$\leq 13.2\text{V}$ and $\geq -10\text{V}$	1	0	0	Normal Operation
$< 0.2\text{V}$ and $\geq 0.12\text{V}$		Indeterminate	Indeterminate	Indeterminate	Indeterminate
$< 0.12\text{V}$ and $\geq -0.12\text{V}$		Indeterminate (Note 2)	1	1	Low Input Differential Voltage
$\leq -0.12\text{V}$ and $\geq -0.2\text{V}$		Indeterminate	Indeterminate	Indeterminate	Indeterminate
$\leq -0.2\text{V}$		0	0	0	Normal Operation
X	$< -10\text{V}$ or $> +13.2\text{V}$	Indeterminate (Note 3)	1	1	Outside Common-Mode Voltage Range

X = Don't care; for B-grade functionality, replace  $V_{ID}$  input values in Table 2 with B-grade parameters from *Electrical Characteristics*.

**Note 1:** ALARMD indicates fault for any receiver.

**Note 2:** Receiver output may oscillate with this differential input condition.

**Note 3:** See *Applications Information* for conditions leading to input range fault condition.



# ±15kV ESD-Protected, 32Mbps, 3V/5V, Triple RS-422/RS-485 Receivers with Fault Detection

## ±15kV ESD Protection

As with all Maxim devices, ESD-protection structures are incorporated on all pins to protect against ESD encountered during handling and assembly. The MAX3097E/MAX3098E receiver inputs have extra protection against static electricity found in normal operation. Maxim's engineers developed state-of-the-art structures to protect these pins against ±15kV ESD without damage. After an ESD event, the MAX3097E/MAX3098E continue working without latching.

ESD protection can be tested in several ways. The receiver inputs are characterized for protection to the following:

- ±15kV using the Human Body Model
- ±8kV using the Contact Discharge method specified in IEC 1000-4-2 (formerly IEC 801-2)
- 15kV using the Air-Gap Discharge method specified in IEC 1000-4-2 (formerly IEC 801-2)

### ESD Test Conditions

ESD performance depends on a number of conditions. Contact Maxim for a reliability report that documents test setup, methodology, and results.

### Human Body Model

Figure 5a shows the Human Body Model, and Figure 5b shows the current waveform it generates when discharged into a low impedance. This model consists of a 100pF capacitor charged to the ESD voltage of interest, which is then discharged into the device through a 1.5kΩ resistor.

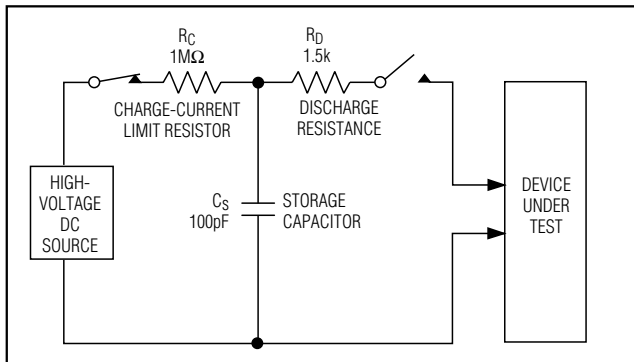

Figure 5a. Human Body ESD Test Model

Since January 1996, all equipment manufactured and/or sold in the European community has been required to meet the stringent IEC 1000-4-2 specification. The IEC 1000-4-2 standard covers ESD testing and performance of finished equipment; it does not specifically refer to integrated circuits. The MAX3097E/MAX3098E help you design equipment that meets Level 4 (the highest level) of IEC 1000-4-2, without additional ESD-protection components.

The main difference between tests done using the Human Body Model and IEC 1000-4-2 is higher peak current in IEC 1000-4-2. Because series resistance is lower in the IEC 1000-4-2 ESD test model (Figure 6a), the ESD-withstand voltage measured to this standard is generally lower than that measured using the Human Body Model. Figure 6b shows the current waveform for the ±8kV IEC 1000-4-2 Level 4 ESD Contact Discharge test. The Air-Gap test involves approaching the device with a charge probe. The Contact Discharge method connects the probe to the device before the probe is energized.

### Machine Model

The Machine Model for ESD testing uses a 200pF storage capacitor and zero-discharge resistance. It mimics the stress caused by handling during manufacturing and assembly. All pins (not just RS-485 inputs) require this protection during manufacturing. Therefore, the Machine Model is less relevant to the I/O ports than are the Human Body Model and IEC 1000-4-2.

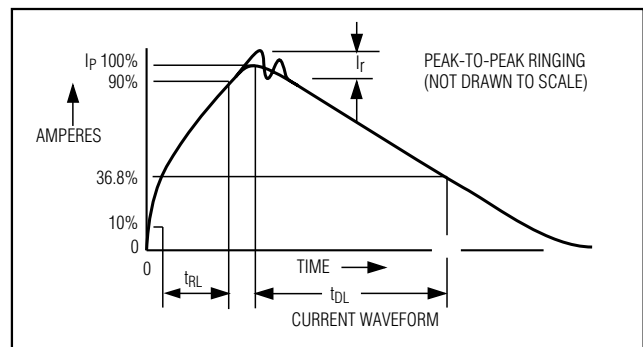

Figure 5b. Human Body Model Current Waveform

# ±15kV ESD-Protected, 32Mbps, 3V/5V, Triple RS-422/RS-485 Receivers with Fault Detection

## Applications Information

### Using the MAX3097E/MAX3098E as Shaft Encoder Receivers

The MAX3097E/MAX3098E are triple RS-485 receivers designed for shaft encoder receiver applications. A shaft encoder is an electromechanical transducer that converts mechanical rotary motion into three RS-485 differential signals. Two signals, A (A and  $\bar{A}$ ) and B (B and  $\bar{B}$ ) provide incremental pulses as the shaft turns, while the index signal, Z (Z and  $\bar{Z}$ ) occurs only once per revolution to allow synchronization of the shaft to a known position. Digital signal processing (DSP) techniques are used to count the pulses and provide feedback of both shaft position and shaft velocity for a stable positioning system.

Shaft encoders typically transmit RS-485 signals over twisted-pair cables since the signal often has to travel across a noisy electrical environment (Figure 7).

### Detecting Faults

Signal integrity from the shaft encoder to the DSP is essential for reliable system operation. Degraded signals could cause problems ranging from simple miscounts to loss of position. In an industrial environment, many problems can occur within the three twisted pairs. The MAX3097E/MAX3098E can detect various types of common faults, including a low-input-level signal, open-circuit wires, short-circuit wires, and an input signal outside the common-mode input voltage range of the receiver.

### Detecting Short Circuits

In Figure 8, if wires A and  $\bar{A}$  are shorted together, then A and  $\bar{A}$  will be at the same potential, so the difference in the voltage between the two will be approximately 0. This causes fault A to trigger since the difference between A -  $\bar{A}$  is less than the differential fault threshold.

### Detecting Open-Circuit Conditions

Detecting an open-circuit condition is similar to detecting a short-circuit condition and relies on the terminating resistor being across A and  $\bar{A}$ . For example, if the wire drops out of the  $\bar{A}$  terminal, A pulls  $\bar{A}$  through the terminating resistor to look like the same signal. In this condition,  $V_{ID}$  is approximately 0 and a fault occurs.

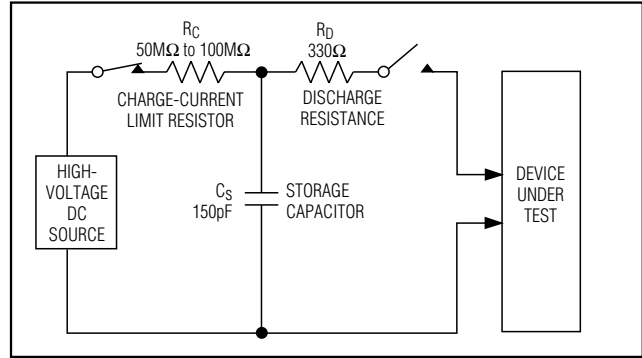

Figure 6a. IEC 1000-4-2 ESD Test Model

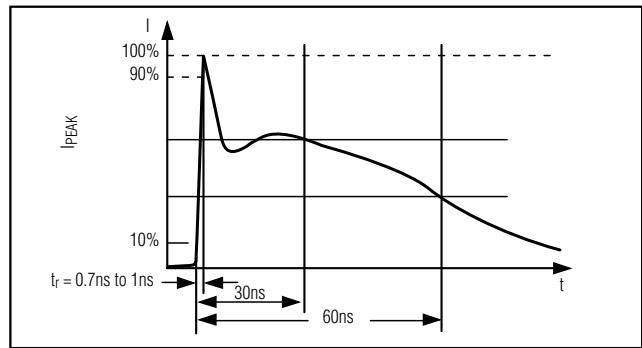

Figure 6b. IEC 1000-4-2 ESD Generator Current Waveform

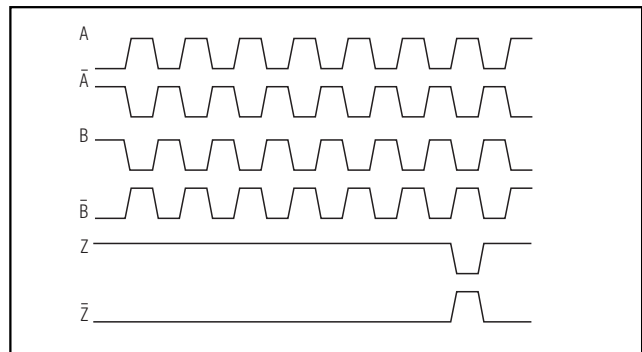

Figure 7. Typical Shaft Encoder Output

# ±15kV ESD-Protected, 32Mbps, 3V/5V, Triple RS-422/RS-485 Receivers with Fault Detection

### Common-Mode Range

The MAX3097E/MAX3098E contain circuitry that detects if the input stage is going outside its useful common-mode range. If the received data could be unreliable, a fault signal is triggered.

### Detecting Low Input Differential

Due to cable attenuation on long wire runs, it is possible that  $V_{ID} < 200\text{mV}$ , and incorrect data will be received. In this condition, a fault will be indicated.

### Delayed Fault Output

The delayed fault output provides a programmable blanking delay to allow transient faults to occur without triggering an alarm. Such faults may occur with slow signals triggering the receiver alarm through the zero crossover region.

Figure 9 shows the delayed alarm output.

ALARMD performs a logic OR of ALARMA, ALARMB, and ALARMZ (Figure 10). A NOR gate drives an N-channel MOSFET so that in normal operation with no faults, the current source ( $10\mu\text{A}$  typ) is shunted to

ground. Upon activation of any alarm from receiver A, B, or Z, the MOSFET is turned off, allowing the current source to charge  $C_{DELAY}$ . When  $V_{DELAY}$  exceeds the DELAY threshold, the comparator output, ALARMD, goes high. ALARMD is reset when all receiver alarms go low, quickly discharging  $C_{DELAY}$  to ground.

### Setting Delay Time

ALARMD's delay time is set with a single capacitor connected from DELAY to GND. The delay comparator threshold varies with supply voltage, and the  $C_{DELAY}$  value can be determined for a given time delay period from the Capacitance vs. ALARMD Output Delay graph in the *Typical Operating Characteristics* or using the following equations:

$$t_D = 15 + 0.33 \times C_{DELAY} \quad (\text{for } V_{CC} = 5\text{V})$$

and

$$t_D = 10 + 0.187 \times C_{DELAY} \quad (\text{for } V_{CC} = 3\text{V})$$

where  $t_D$  is in  $\mu\text{s}$  and  $C_{DELAY}$  is in pF.

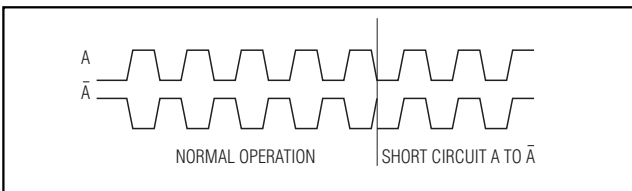

Figure 8. Short-Circuit Detection

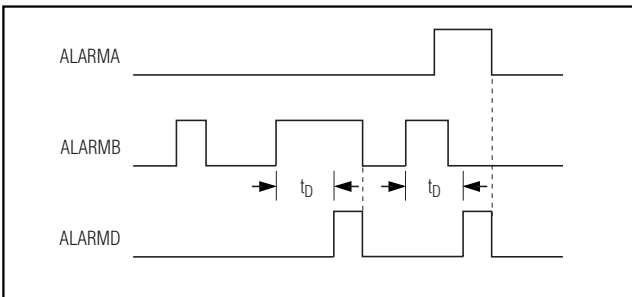
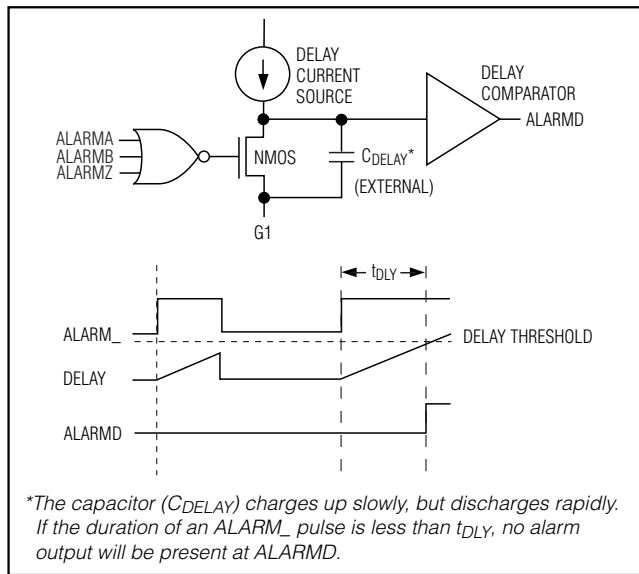

Figure 9. Delayed Alarm Output



\*The capacitor ( $C_{DELAY}$ ) charges up slowly, but discharges rapidly. If the duration of an  $ALARM_$  pulse is less than  $t_{DLY}$ , no alarm output will be present at ALARMD.

Figure 10. ALARMD Simplified Schematic

# **$\pm 15\text{kV}$ ESD-Protected, 32Mbps, 3V/5V, Triple RS-422/RS-485 Receivers with Fault Detection**

## **Ordering Information (continued)**

<b>PART</b>	<b>TEMP. RANGE</b>	<b>PIN-PACKAGE</b>
MAX3097ECPE	0°C to +70°C	16 Plastic DIP
MAX3097EEEE	-40°C to +85°C	16 QSOP
MAX3097EESE	-40°C to +85°C	16 SO
MAX3097EEPE	-40°C to +85°C	16 Plastic DIP
<b>MAX3098E</b> ACEE	0°C to +70°C	16 QSOP
MAX3098EACSE	0°C to +70°C	16 SO
MAX3098EACPE	0°C to +70°C	16 Plastic DIP
MAX3098EAEEE	-40°C to +85°C	16 QSOP
MAX3098EAESE	-40°C to +85°C	16 SO
MAX3098EAEPE	-40°C to +85°C	16 Plastic DIP
MAX3098EBCEE	0°C to +70°C	16 QSOP
MAX3098EBCSE	0°C to +70°C	16 SO
MAX3098EBCPE	0°C to +70°C	16 Plastic DIP
MAX3098EBEEE	-40°C to +85°C	16 QSOP
MAX3098EBESE	-40°C to +85°C	16 SO
MAX3098EBEPE	-40°C to +85°C	16 Plastic DIP

## **Functional Diagram**

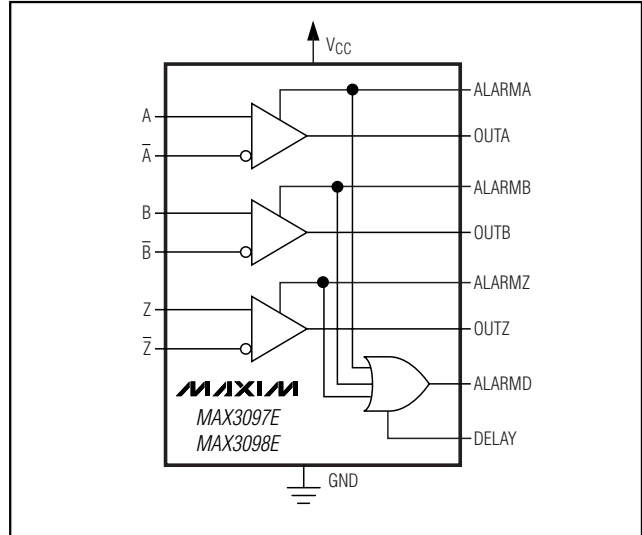

## **Chip Information**

TRANSISTOR COUNT: 675  
 PROCESS: CMOS

# ±15kV ESD-Protected, 32Mbps, 3V/5V, Triple RS-422/RS-485 Receivers with Fault Detection

## Package Information

**MAX3097E/MAX3098E**

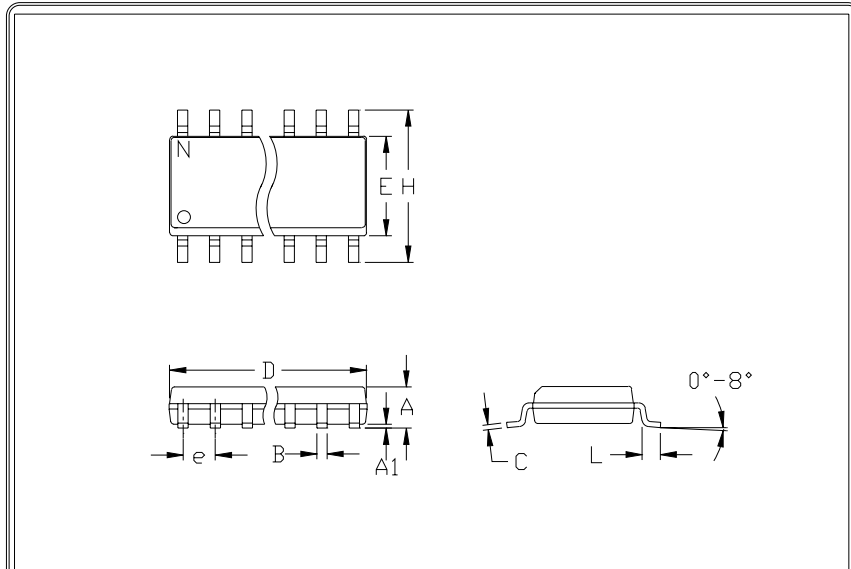

	INCHES		MILLIMETERS	
	MIN	MAX	MIN	MAX
A	0.053	0.069	1.35	1.75
A1	0.004	0.010	0.10	0.25
B	0.014	0.019	0.35	0.49
C	0.007	0.010	0.19	0.25
e	0.050		1.27	
E	0.150	0.157	3.80	4.00
H	0.228	0.244	5.80	6.20
h	0.010	0.020	0.25	0.50
L	0.016	0.050	0.40	1.27

	INCHES		MILLIMETERS		N	MS012
	MIN	MAX	MIN	MAX		
D	0.189	0.197	4.80	5.00	8	A
D	0.337	0.344	8.55	8.75	14	B
D	0.386	0.394	9.80	10.00	16	C

**NOTES:**

1. D&E DO NOT INCLUDE MOLD FLASH
2. MOLD FLASH OR PROTRUSIONS NOT TO EXCEED .15mm (.006")
3. LEADS TO BE COPLANAR WITHIN .102mm (.004")
4. CONTROLLING DIMENSION: MILLIMETER
5. MEETS JEDEC MS012-XX AS SHOWN IN ABOVE TABLE
6. N = NUMBER OF PINS



PACKAGE FAMILY OUTLINE: SOIC .150" TITLE

1/1

21-0041 A DOCUMENT CONTROL NUMBER REV

**±15kV ESD-Protected, 32Mbps, 3V/5V, Triple RS-422/RS-485 Receivers with Fault Detection**

**Package Information (continued)**

DIM	INCHES		MILLIMETERS	
	MIN	MAX	MIN	MAX
A	.061	.068	1.55	1.73
A1	.004	.0098	0.102	0.249
A2	.055	.061	1.40	1.55
B	.008	.012	0.20	0.31
C	.0075	.0098	0.191	0.249
D	SEE VARIATIONS			
E	.150	.157	3.81	3.99
e	.025	BSC	0.635	BSC
H	.230	.244	5.84	6.20
h	.010	.016	0.25	0.41
L	.016	.035	0.41	0.89
N	SEE VARIATIONS			
X	SEE VARIATIONS			
Y	.071	.087	1.803	2.209
α	0°	8°	0°	8°

DIM	INCHES		MILLIMETERS		N
	MIN.	MAX.	MIN.	MAX.	
D	.189	.196	4.80	4.98	16/AA
S	.0020	.0070	0.05	0.18	
X	.107	.123	2.72	3.12	
D	.337	.344	8.56	8.74	20/AB
S	.0500	.0550	1.270	1.397	
D	.337	.344	8.56	8.74	24/AC
S	.0250	.0300	0.635	0.762	
D	.386	.393	9.80	9.98	28/AD
S	.0250	.0300	0.635	0.762	
X	.271	.287	6.88	7.29	

NOTES:

1. D & E DO NOT INCLUDE MOLD FLASH OR PROTRUSIONS
2. MOLD FLASH OR PROTRUSIONS NOT TO EXCEED .006" PER SIDE.
3. HEAT SLUG DIMENSIONS X AND Y APPLY ONLY TO 16 AND 28 LEAD POWER-QSDP PACKAGES.
4. CONTROLLING DIMENSIONS: INCHES.

MAXIM  
 PROPRIETARY INFORMATION  
 TITLE  
 PACKAGE OUTLINE, QSDP, .150", .025" LEAD PITCH  
 APPROVAL DOCUMENT CONTROL NO. REV B 1/1  
 21-0055

# ±15kV ESD-Protected, 32Mbps, 3V/5V, Triple RS-422/RS-485 Receivers with Fault Detection

## Package Information (continued)

**MAX3097E/MAX3098E**

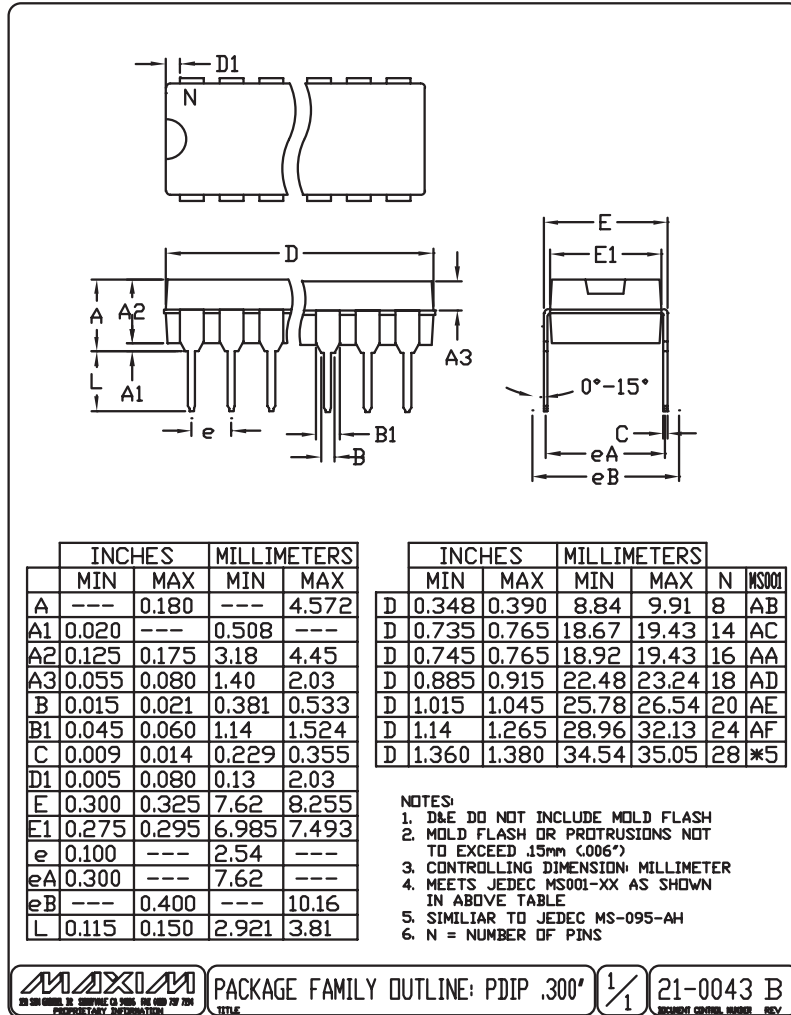

**$\pm 15\text{kV}$  ESD-Protected, 32Mbps, 3V/5V,  
Triple RS-422/RS-485 Receivers with Fault Detection**

**NOTES**

*Maxim cannot assume responsibility for use of any circuitry other than circuitry entirely embodied in a Maxim product. No circuit patent licenses are implied. Maxim reserves the right to change the circuitry and specifications without notice at any time.*

16 \_\_\_\_\_ **Maxim Integrated Products, 120 San Gabriel Drive, Sunnyvale, CA 94086 408-737-7600**



## X-ON Electronics

Largest Supplier of Electrical and Electronic Components

*Click to view similar products for [RS-422/RS-485 Interface IC](#) category:*

*Click to view products by [Maxim](#) manufacturer:*

Other Similar products are found below :

[402824F](#) [702835FB](#) [MAX488ECPA](#) [MAX3491CSDT](#) [MAX3490AEGSA+](#) [MAX3483AEASA+](#) [MAX3491EESDT](#) [MAX3488AEGSA+](#)  
[MAX3083CSD](#) [MAX487CSA](#) [SP3071EEN-L](#) [SP3072EEN-L/TR](#) [SP3075EEN-L](#) [SP3075EEN-L/TR](#) [SP3077EEN-L](#) [SP3078EEN-L](#)  
[SP3078EEN-L/TR](#) [SP3082EEN-L](#) [SP3088EEN-L](#) [SP3483CN-L](#) [SP3483CN-L/TR](#) [SP3483EN-L](#) [SP3485CN-L](#) [SP3485CN-L/TR](#) [SP3485EN-](#)  
[L](#) [SP3485EN-L/TR](#) [SP3490EN-L](#) [SP3494EN-L](#) [SP481EEN-L/TR](#) [SP483EN-L/TR](#) [SP490EEN-L/TR](#) [SP491EN-L/TR](#) [XR3078XID-F](#)  
[SP3082EEN-L/TR](#) [SP330EEY-L/TR](#) [MAX14783EATA+T](#) [MAX3098EBCEE+T](#) [MAX3045BESE+T](#) [MAX22501EATA+T](#)  
[MAX22502EATC+T](#) [MAX3042BCSE+T](#) [SP3077EEN-L/TR](#) [MAX487ESA+TCBX](#) [MAX1483CUA+T](#) [MAX487CUA+T](#) [CA-IS3082W](#) [CA-](#)  
[IS3088W](#) [SP3074EEN-L/TR](#) [NSI83085](#) [MAX3097EESE+T](#)