

## AirMatrix<sup>®</sup> Surface Mount Fuses

### AF Series, 1206 Size



#### Features:

- Fast acting at 250% overload current level
- Excellent inrush current withstanding capability
- Extremely thin body for space saving
- Much safer with wire-in-air design
- Fiberglass enforced epoxy fuse body
- Copper termination with nickel and tin plating
- Operating temperature range: -55°C to +125 °C (with de-rating)
- 100% lead-free

#### Application Fields:

- Notebook, Ultrabook
- Backlight Driver
- DC/DC Converter
- Low voltage lighting power
- Automotive electronics

#### Shape and Dimensions:

Unit	Inch	mm
L	0.126 ± 0.008	3.20 ± 0.20
W	0.063 + 0.012 / -0.004	1.60 + 0.30 / -0.20
T	0.042 ± 0.006	1.08 ± 0.15
B	0.033 ± 0.012	0.85 ± 0.30

#### Clearing Time Characteristics:

% of Current Rating	Clearing Time at 25°C	
	Min.	Max.
100%	4 hour	
250%		5 seconds

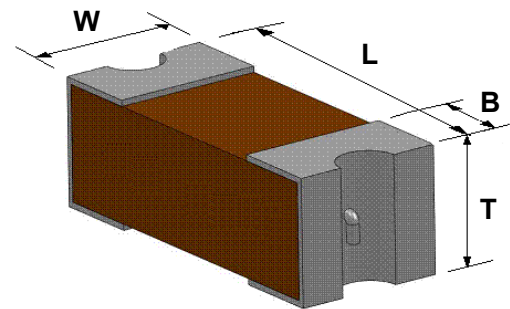

#### Agency Approval:

Recognized Under the Components Program of Underwriters Laboratories. File Number: E232989

## AirMatrix® Surface Mount Fuses

### AF Series, 1206 Size

#### Ordering Information:

Part Number	Current Rating (A)	Marking ( White )	Voltage Rating (VDC)	Interrupting Rating	Nominal DCR (Ω)	Nominal I <sup>2</sup> t (A <sup>2</sup> s)
AF1206F1.50TM	1.50	G	65	50A@65VDC	0.050	0.37
AF1206F1.60TM	1.60	T			0.043	0.52
AF1206F2.00TM	2.00	I			0.032	0.88
AF1206F2.50TM	2.50	J			0.028	1.1
AF1206F3.00TM	3.00	K			0.022	1.9
AF1206F3.15TM	3.15	V			0.020	2.2
AF1206F3.50TM	3.50	L			0.018	2.6
AF1206F4.00TM	4.00	M			0.016	3.3
AF1206F5.00TM	5.00	N	32	50A@32VDC	0.013	5.4
AF1206F6.30TM	6.30	O			0.010	8.9
AF1206F7.00TM	7.00	P			0.0092	10.4
AF1206F8.00TM	8.00	R			0.0084	13.5
AF1206F10.0TM	10.0	Q			0.0050	11.2
AF1206F12.0TM	12.0	X			0.0041	15.0
AF1206F15.0TM	15.0	Y			0.0035	24.5

1. Resistance is measured at  $\leq 10\%$  of rated current and 25°C ambient.
2. Melting I<sup>2</sup>t is calculated at 0.001 second pre-arcing time.

# AirMatrix<sup>®</sup> Surface Mount Fuses

## AF Series, 1206 Size

### Average Pre-arcing Time Curves:

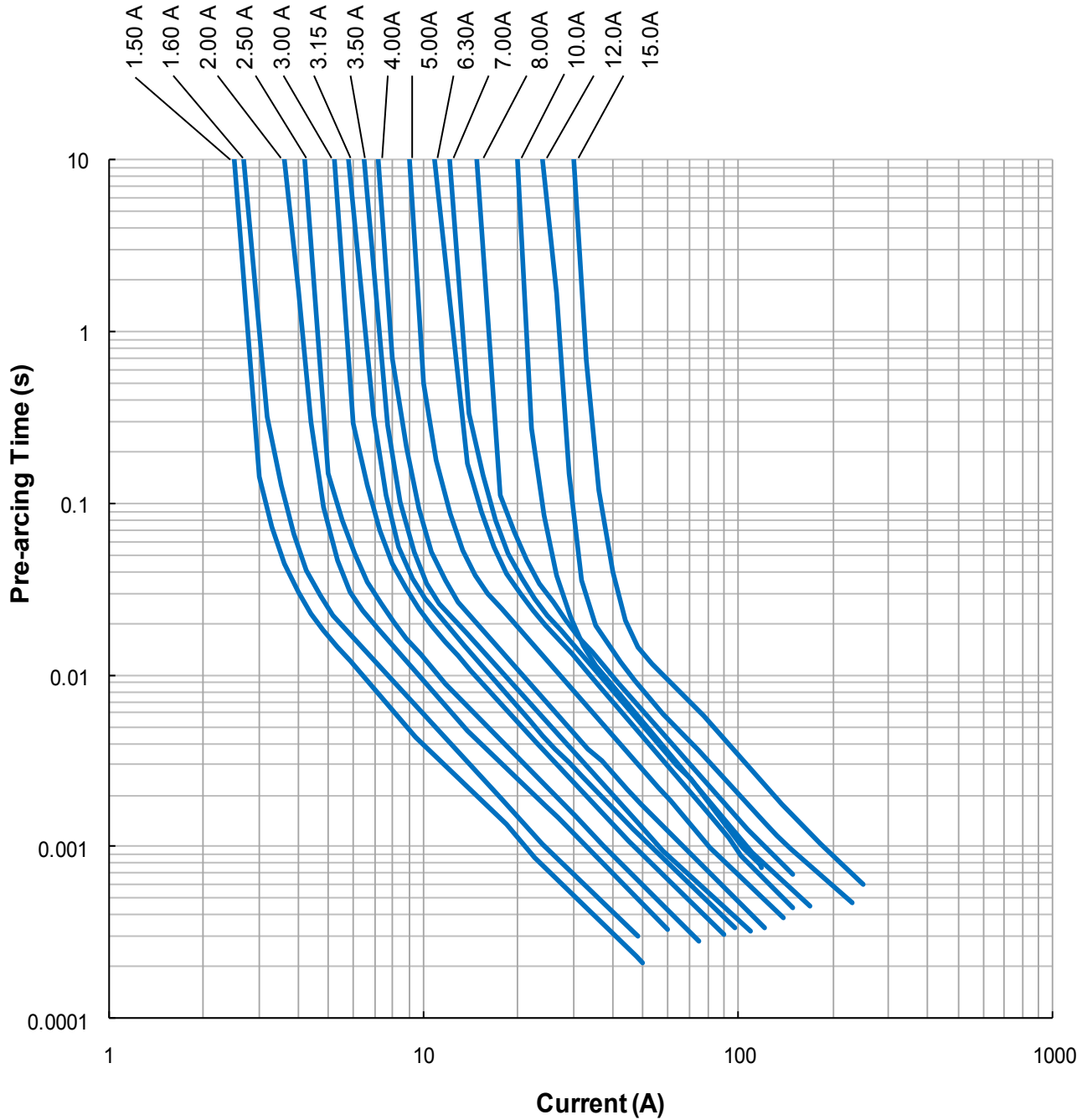

# AirMatrix<sup>®</sup> Surface Mount Fuses

## AF Series, 1206 Size

### Average $I^2t$ vs. $t$ Curves:

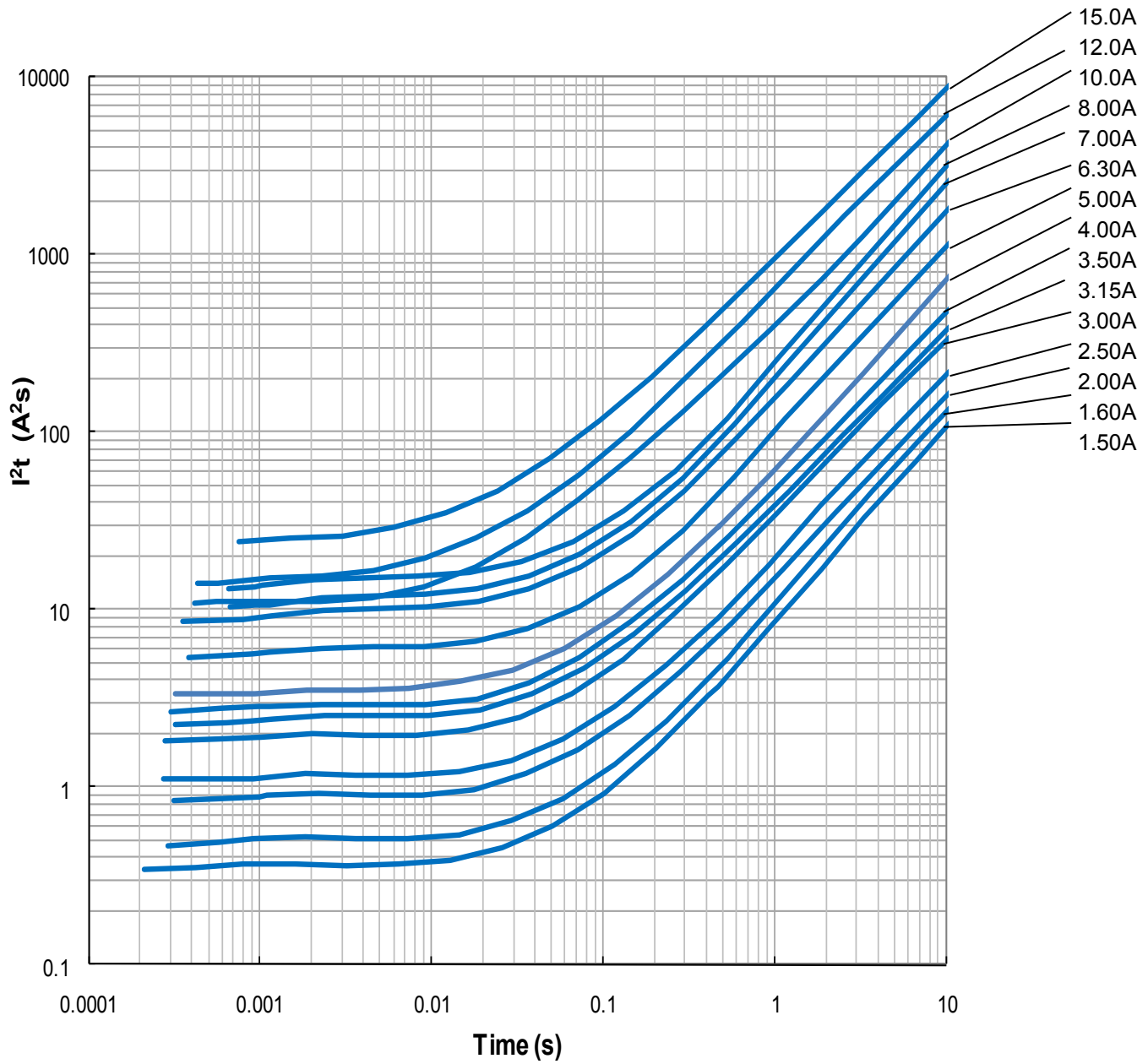

## AirMatrix® Surface Mount Fuses

### Product Identification:

#### AF2 1.00 V125 T M

(1) (2) (3) (4) (5)

- (1) **Series Code:** AF2
- (2) **Current Rating Code:** 1.00—1.00A
- (3) **Voltage Rating Code:** V125—125VDC
- (4) **Package Code:** T - Tape & Reel, B - Bulk
- (5) **Marking Code:** M - With Marking

#### AF 1206 F 2.00 T M

(1) (2) (3) (4) (5) (6)

- (1) **Series Code:** AF—AF Series, MF—MF Series
- (2) **Size Code:** Standard EIA Chip Sizes
- (3) **Time/Current Characteristic:** F
- (4) **Current Rating:** 2.00—2.00A
- (5) **Package Code:** T - Tape & Reel, B - Bulk
- (6) **Marking Code:** M - With Marking

### Recommended Land Pattern:

	AF2		AF1206		MF2410		MF1210	
	Inch	mm	Inch	mm	Inch	mm	Inch	mm
<b>L</b>	0.338	8.60	0.173	4.40	0.338	8.60	0.170	4.40
<b>G</b>	0.118	3.00	0.059	1.50	0.118	3.00	0.070	1.70
<b>H</b>	0.124	3.15	0.071	1.80	0.110	2.80	0.110	2.70

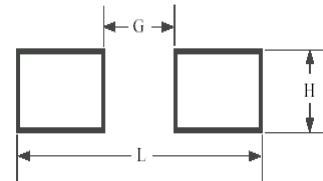

### Packaging:

Chip Size	Parts on 7 inch (178 mm) Reel
2410 (6125)	2,000
1210 (3225)	2,500
1206 (3216)	3,500

### Storage:

The maximum ambient temperature shall not exceed 35°C . Storage temperatures higher than 35°C could result in the deformation of packaging materials.

The maximum relative humidity recommended for storage is 75%. High humidity with high temperature can accelerate the oxidation of the solder plating on the termination and reduce the solderability of the components.

Sealed vacuum foil bags with desiccant should only be opened prior to use.

## AirMatrix<sup>®</sup> Surface Mount Fuses

### Fuse Selection and Temperature De-rating Guideline:

The ambient temperature affects the current carrying capacity of fuses. When a fuse is operating at a temperature higher than 25°C, the fuse shall be “de-rated”.

To select a fuse from the catalog, the following rule may be followed:

Catalog Fuse Current Rating = Nominal Operating Current / 0.75 / % De-rating at the maximum operating temperature.

Example: At maximum operating temperature of 65°C, % De-rating is 90%. The nominal operating current is 4 A. The current rating for fuse selected from the catalog shall be:

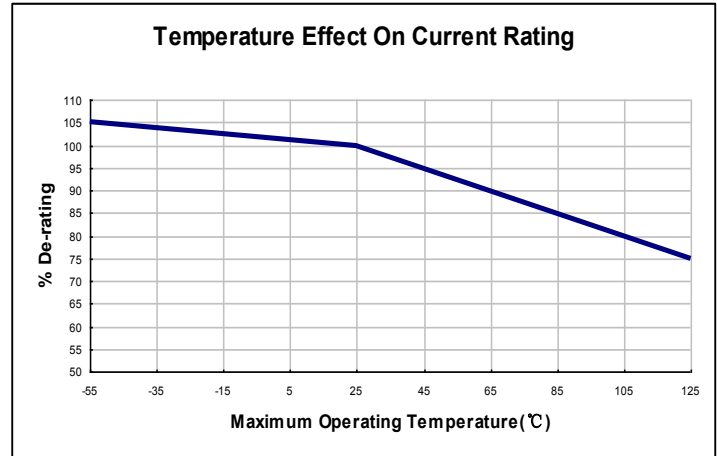

### Environmental Tests:

Reliability Test	Test Condition and Requirement	Test Reference
Reflow & Bend	3 reflows at 245°C followed by a 2 mm bend, 20% DCR change max. (10% for ≤ 1 A), no mechanical damage	Refer to AEM QIQ034 ,QIQ048
Solderability	245°C, 5 seconds, new solder coverage 90% minimum	MIL-STD-202 Method 208
Soldering Heat Resistance	260°C, 10 seconds, 20% DCR change max. (10% for ≤ 1 A), new solder coverage 75% minimum	MIL-STD-202 Method 210
Life	25°C, 2000 hours, 80% rated current (75% for < 1 A), voltage drop change ≤ ±20%	Refer to AEM QIQ106
Thermal Shock	-65°C to +125°C, 100 cycles, 10% DCR change max., no mechanical damage	MIL-STD-202 Method 107
Mechanical Vibration	5 – 3000 Hz, 0.4 inch double amplitude or 30 G peak, 10% DCR change max., no mechanical damage	MIL-STD-202 Method 204
Mechanical Shock	1500 G, 0.5 milliseconds, half-sine shocks, 10% DCR change max., no mechanical damage	MIL-STD-202 Method 213
Salt Spray	5% salt solution, 48 hour exposure, 10% DCR change max., no excessive corrosion	MIL-STD-202 Method 101
Moisture Resistance	10 cycles, 15% DCR change max., no excessive corrosion	MIL-STD-202 Method 106

# AirMatrix<sup>®</sup> Surface Mount Fuses

## Soldering Temperature Profile:

\* Recommended Temperature Profile for Reflow Soldering

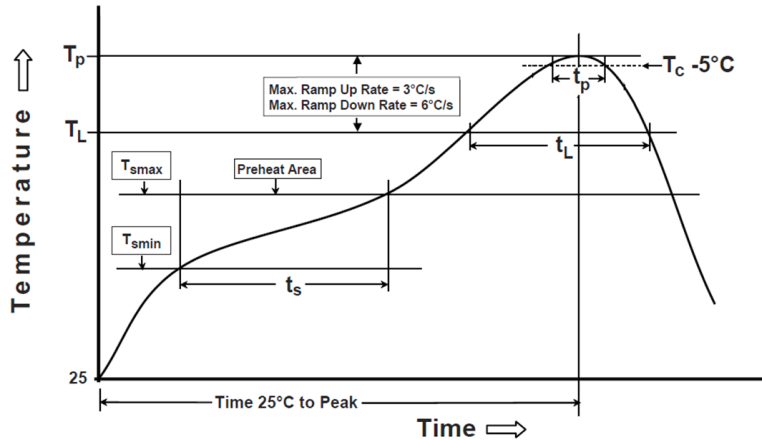

Profile Feature	Pb-Free Assembly
<b>Preheat/Soak</b> Temperature Min ( $T_{smin}$ ) Temperature Max ( $T_{smax}$ ) Time ( $t_s$ ) from ( $T_{smin}$ to $T_{smax}$ )	150°C 200°C 60~120 seconds
Ramp-up rate ( $T_L$ to $T_p$ )	3°C/second max.
Liquidous temperature ( $T_L$ ) Time ( $t_L$ ) maintained above $T_L$	217°C 60~150 seconds
Peak package body temperature ( $T_p$ )	260°C
Time ( $t_p$ )*within 5°C of the specified classification temperature ( $T_c$ )	30 seconds *
Ramp-down rate ( $T_p$ to $T_L$ )	6°C/second max.
Time 25°C to peak temperature	8 minutes max.
* Tolerance for peak profile temperature ( $T_p$ ) is defined as a supplier minimum and a user maximum	

\* Recommended Temperature Profile for Wave Soldering

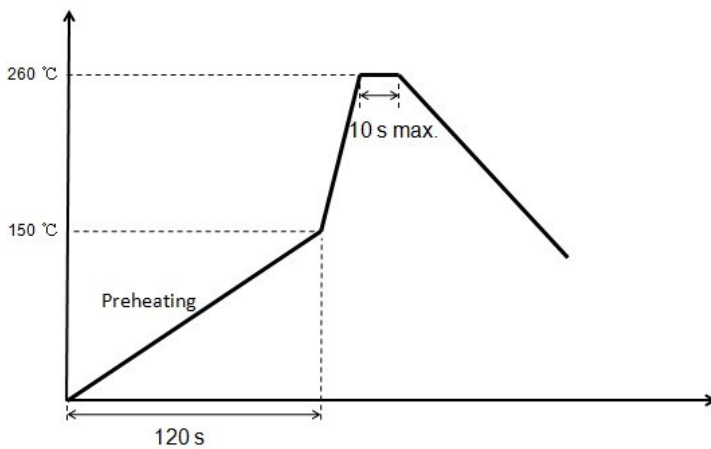

## Disclaimer

*Specifications are subject to change without notice. AEM products are designed for specific applications and should not be used for any purpose (including, without limitation, automotive, aerospace, medical, life-saving applications, or any other application which requires especially high reliability for the prevention of such defect as may directly cause damage to the third party's life, body or property) not expressly set forth in applicable AEM product documentation. It is the customer's responsibility to validate that a particular product with the properties described in the product specification is suitable for use in a particular application. Warranties granted by AEM shall be deemed void for products used for any purpose not expressly set forth in applicable AEM product documentation. AEM shall not be liable for any claims or damages arising out of products used in applications not expressly intended by AEM as set forth in applicable AEM product documentation. The sale and use of AEM products is subject to AEM terms and conditions of sale. Please refer*



## X-ON Electronics

Largest Supplier of Electrical and Electronic Components

*Click to view similar products for [Surface Mount Fuses](#) category:*

*Click to view products by [AEM](#) manufacturer:*

Other Similar products are found below :

[FHC20402ADTP](#) [FT600-0500-2](#) [NFVC6125S0R50TRF](#) [SFT-125MA](#) [TF16SN2.00TTD](#) [TF16SN3.15TTD](#) [41921000000](#) [TR/3216LR-500MA](#) [CCP2B20TTE](#) [TR-3216FF4-R](#) [SST 1-1K](#) [SST 5 -1K](#) [SST 2-1K](#) [TR2-TCP500-R](#) [F60C500V12AS](#) [FCC16501ABTP](#) [FCC16102ABTP](#) [FHC16322ADTP](#) [0308.250UR](#) [0308.375UR](#) [0308.500UR](#) [0308.750UR](#) [0308001.UR](#) [030801.5UR](#) [FCC16202ABTP](#) [3-122-714](#) [3-122-720](#) [3-122-718](#) [3-122-712](#) [3-122-716](#) [03081.25UR](#) [CQ06LF 5A 32V](#) [CQ06LT 5A 32V](#) [SET 2A 125V \(G\)](#) [SET 1A 125V \(G\)](#) [SEF 10A 125V \(G\)](#) [SEF 3A 125V \(G\)](#) [SEF 4A 125V \(G\)](#) [SEF 6A 125V \(G\)](#) [SEF 7A 125V \(G\)](#) [SET 4A 125V \(G\)](#) [SET 3A 125V \(G\)](#) [SET 5A 125V \(G\)](#) [SET 7A 125V \(G\)](#) [F0603G0R03FNTR](#) [SKY87604-12](#) [SKY87604-11](#) [SKY87604-13](#) [0154002.DRL](#) [0154008.DRL](#)