



Is Now Part of



**ON Semiconductor®**

To learn more about ON Semiconductor, please visit our website at  
[www.onsemi.com](http://www.onsemi.com)

Please note: As part of the Fairchild Semiconductor integration, some of the Fairchild orderable part numbers will need to change in order to meet ON Semiconductor's system requirements. Since the ON Semiconductor product management systems do not have the ability to manage part nomenclature that utilizes an underscore (\_), the underscore (\_) in the Fairchild part numbers will be changed to a dash (-). This document may contain device numbers with an underscore (\_). Please check the ON Semiconductor website to verify the updated device numbers. The most current and up-to-date ordering information can be found at [www.onsemi.com](http://www.onsemi.com). Please email any questions regarding the system integration to [Fairchild\\_questions@onsemi.com](mailto:Fairchild_questions@onsemi.com).

ON Semiconductor and the ON Semiconductor logo are trademarks of Semiconductor Components Industries, LLC dba ON Semiconductor or its subsidiaries in the United States and/or other countries. ON Semiconductor owns the rights to a number of patents, trademarks, copyrights, trade secrets, and other intellectual property. A listing of ON Semiconductor's product/patent coverage may be accessed at [www.onsemi.com/site/pdf/Patent-Marking.pdf](http://www.onsemi.com/site/pdf/Patent-Marking.pdf). ON Semiconductor reserves the right to make changes without further notice to any products herein. ON Semiconductor makes no warranty, representation or guarantee regarding the suitability of its products for any particular purpose, nor does ON Semiconductor assume any liability arising out of the application or use of any product or circuit, and specifically disclaims any and all liability, including without limitation special, consequential or incidental damages. Buyer is responsible for its products and applications using ON Semiconductor products, including compliance with all laws, regulations and safety requirements or standards, regardless of any support or applications information provided by ON Semiconductor. "Typical" parameters which may be provided in ON Semiconductor data sheets and/or specifications can and do vary in different applications and actual performance may vary over time. All operating parameters, including "Typicals" must be validated for each customer application by customer's technical experts. ON Semiconductor does not convey any license under its patent rights nor the rights of others. ON Semiconductor products are not designed, intended, or authorized for use as a critical component in life support systems or any FDA Class 3 medical devices or medical devices with a same or similar classification in a foreign jurisdiction or any devices intended for implantation in the human body. Should Buyer purchase or use ON Semiconductor products for any such unintended or unauthorized application, Buyer shall indemnify and hold ON Semiconductor and its officers, employees, subsidiaries, affiliates, and distributors harmless against all claims, costs, damages, and expenses, and reasonable attorney fees arising out of, directly or indirectly, any claim of personal injury or death associated with such unintended or unauthorized use, even if such claim alleges that ON Semiconductor was negligent regarding the design or manufacture of the part. ON Semiconductor is an Equal Opportunity/Affirmative Action Employer. This literature is subject to all applicable copyright laws and is not for resale in any manner.

# FGA15N120ANTDTU

## 1200 V, 15 A NPT Trench IGBT

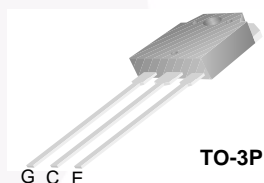
### Features

- NPT Trench Technology, Positive temperature coefficient
- Low Saturation Voltage:  $V_{CE(sat), typ} = 1.9\text{ V}$   
@  $I_C = 15\text{ A}$  and  $T_C = 25^\circ\text{C}$
- Low Switching Loss:  $E_{off, typ} = 0.6\text{ mJ}$   
@  $I_C = 15\text{ A}$  and  $T_C = 25^\circ\text{C}$
- Extremely Enhanced Avalanche Capability

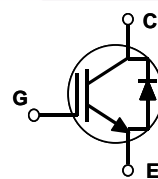
### Description

Using Fairchild's proprietary trench design and advanced NPT technology, the 1200V NPT IGBT offers superior conduction and switching performances, high avalanche ruggedness and easy parallel operation.

This device is well suited for the resonant or soft switching application such as induction heating, microwave oven.



TO-3P



### Absolute Maximum Ratings

Symbol	Description	Ratings	Unit
$V_{CES}$	Collector-Emitter Voltage	1200	V
$V_{GES}$	Gate-Emitter Voltage	$\pm 20$	V
$I_C$	Collector Current	@ $T_C = 25^\circ\text{C}$	30
	Collector Current	@ $T_C = 100^\circ\text{C}$	15
$I_{CM}$	Pulsed Collector Current (Note 1)	45	A
$I_F$	Diode Continuous Forward Current	@ $T_C = 25^\circ\text{C}$	30
	Diode Continuous Forward Current	@ $T_C = 100^\circ\text{C}$	15
$I_{FM}$	Diode Maximum Forward Current	45	A
$P_D$	Maximum Power Dissipation	@ $T_C = 25^\circ\text{C}$	186
	Maximum Power Dissipation	@ $T_C = 100^\circ\text{C}$	74
$T_J$	Operating Junction Temperature	-55 to +150	$^\circ\text{C}$
$T_{stg}$	Storage Temperature Range	-55 to +150	$^\circ\text{C}$
$T_L$	Maximum Lead Temp. for soldering Purposes, 1/8" from case for 5 seconds	300	$^\circ\text{C}$

### Thermal Characteristics

Symbol	Parameter	Typ.	Max.	Unit
$R_{\theta JC}$	Thermal Resistance, Junction-to-Case for IGBT	--	0.67	$^\circ\text{C/W}$
$R_{\theta JC}$	Thermal Resistance, Junction-to-Case for Diode	--	2.88	$^\circ\text{C/W}$
$R_{\theta JA}$	Thermal Resistance, Junction-to-Ambient	--	40	$^\circ\text{C/W}$

**Notes:**

(1) Repetitive rating: Pulse width limited by max. junction temperature

## Package Marking and Ordering Information

Part Number	Top Mark	Package	Packing Method	Reel Size	Tape Width	Quantity
FGA15N120ANTDTU_F109	FGA15N120ANTDTU	TO-3P	Tube	N/A	N/A	30

## Electrical Characteristics of the IGBT T<sub>C</sub> = 25°C unless otherwise noted

Symbol	Parameter	Test Conditions	Min.	Typ.	Max.	Unit
<b>Off Characteristics</b>						
I <sub>CES</sub>	Collector Cut-Off Current	V <sub>CE</sub> = V <sub>CES</sub> , V <sub>GE</sub> = 0 V	--	--	3	mA
I <sub>GES</sub>	G-E Leakage Current	V <sub>GE</sub> = V <sub>GES</sub> , V <sub>CE</sub> = 0 V	--	--	± 250	nA
<b>On Characteristics</b>						
V <sub>GE(th)</sub>	G-E Threshold Voltage	I <sub>C</sub> = 15 mA, V <sub>CE</sub> = V <sub>GE</sub>	4.5	6.5	8.5	V
V <sub>CE(sat)</sub>	Collector to Emitter Saturation Voltage	I <sub>C</sub> = 15 A, V <sub>GE</sub> = 15 V	--	1.9	2.4	V
		I <sub>C</sub> = 15 A, V <sub>GE</sub> = 15 V, T <sub>C</sub> = 125°C	--	2.2	--	V
		I <sub>C</sub> = 30 A, V <sub>GE</sub> = 15 V	--	2.3	--	V
<b>Dynamic Characteristics</b>						
C <sub>ies</sub>	Input Capacitance	V <sub>CE</sub> = 30 V, V <sub>GE</sub> = 0 V, f = 1 MHz	--	2650	--	pF
C <sub>oes</sub>	Output Capacitance		--	143	--	pF
C <sub>res</sub>	Reverse Transfer Capacitance		--	96	--	pF
<b>Switching Characteristics</b>						
t <sub>d(on)</sub>	Turn-On Delay Time	V <sub>CC</sub> = 600 V, I <sub>C</sub> = 15 A, R <sub>G</sub> = 10 Ω, V <sub>GE</sub> = 15 V, Inductive Load, T <sub>C</sub> = 25°C	--	15	--	ns
t <sub>r</sub>	Rise Time		--	20	--	ns
t <sub>d(off)</sub>	Turn-Off Delay Time		--	160	--	ns
t <sub>f</sub>	Fall Time		--	100	180	ns
E <sub>on</sub>	Turn-On Switching Loss		--	3	4.5	mJ
E <sub>off</sub>	Turn-Off Switching Loss		--	0.6	0.9	mJ
E <sub>ts</sub>	Total Switching Loss		--	3.6	5.4	mJ
t <sub>d(on)</sub>	Turn-On Delay Time	V <sub>CC</sub> = 600 V, I <sub>C</sub> = 15 A, R <sub>G</sub> = 10 Ω, V <sub>GE</sub> = 15 V, Inductive Load, T <sub>C</sub> = 125°C	--	15	--	ns
t <sub>r</sub>	Rise Time		--	20	--	ns
t <sub>d(off)</sub>	Turn-Off Delay Time		--	170	--	ns
t <sub>f</sub>	Fall Time		--	150	--	ns
E <sub>on</sub>	Turn-On Switching Loss		--	3.2	4.8	mJ
E <sub>off</sub>	Turn-Off Switching Loss		--	0.8	1.2	mJ
E <sub>ts</sub>	Total Switching Loss		--	4.0	6.0	mJ
Q <sub>g</sub>	Total Gate Charge	V <sub>CE</sub> = 600 V, I <sub>C</sub> = 15 A, V <sub>GE</sub> = 15 V	--	120	180	nC
Q <sub>ge</sub>	Gate-Emitter Charge		--	16	22	nC
Q <sub>gc</sub>	Gate-Collector Charge		--	50	65	nC

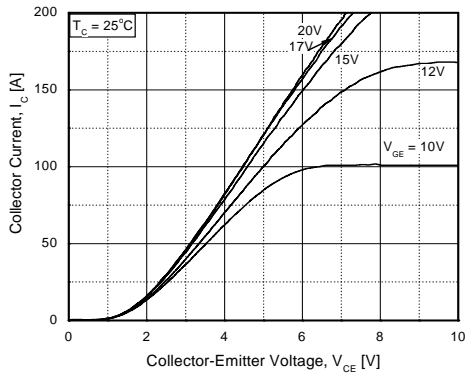
**Electrical Characteristics of DIODE**  $T_C = 25^\circ\text{C}$  unless otherwise noted

Symbol	Parameter	Test Conditions	Min.	Typ.	Max.	Unit	
$V_{FM}$	Diode Forward Voltage	$I_F = 15\text{ A}$	$T_C = 25^\circ\text{C}$	--	1.7	2.7	V
			$T_C = 125^\circ\text{C}$	--	1.8	--	
$t_{rr}$	Diode Reverse Recovery Time	$I_F = 15\text{ A}$ $di_F/dt = 200\text{ A}/\mu\text{s}$	$T_C = 25^\circ\text{C}$	--	210	330	ns
			$T_C = 125^\circ\text{C}$	--	280	--	
$I_{rr}$	Diode Peak Reverse Recovery Current		$T_C = 25^\circ\text{C}$	--	27	40	A
			$T_C = 125^\circ\text{C}$	--	31	--	
$Q_{rr}$	Diode Reverse Recovery Charge		$T_C = 25^\circ\text{C}$	--	2835	6600	nC
			$T_C = 125^\circ\text{C}$	--	4340	--	

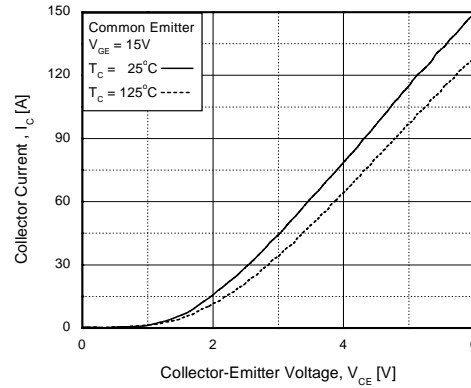


## Typical Performance Characteristics

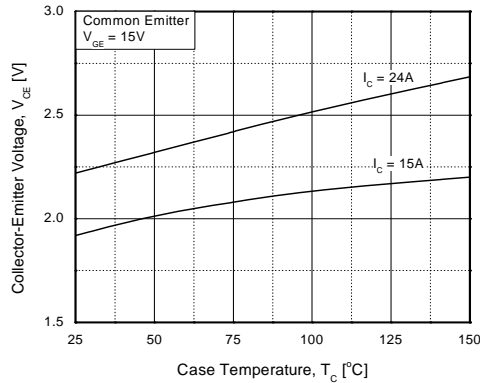
**Figure 1. Typical Output Characteristics**



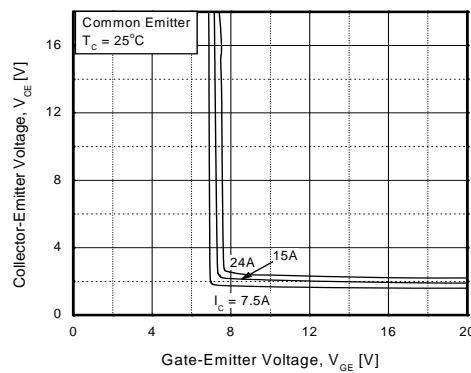
**Figure 2. Typical Saturation Voltage Characteristics**



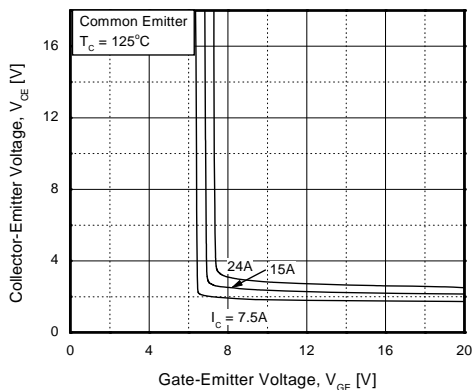
**Figure 3. Saturation Voltage vs. Case Temperature at Variant Current Level**



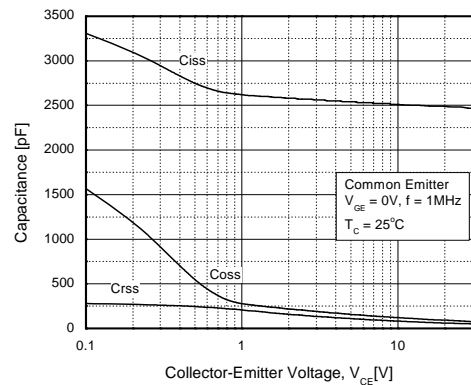
**Figure 4. Saturation Voltage vs. V\_GE**



**Figure 5. Saturation Voltage vs. V\_GE**

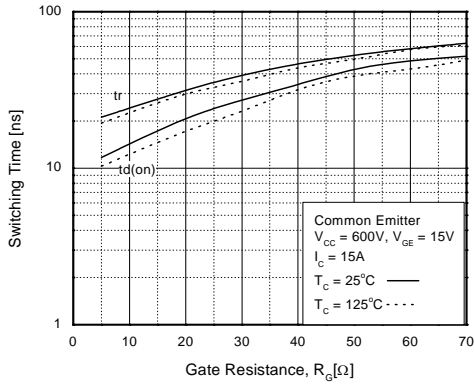


**Figure 6. Capacitance Characteristics**

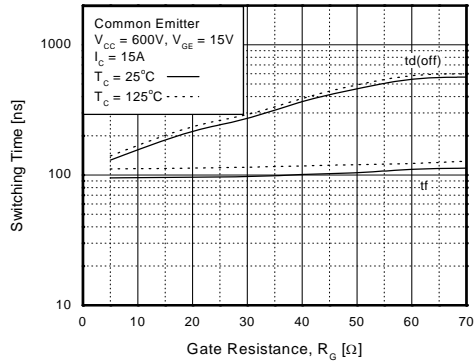


**Typical Performance Characteristics** (Continued)

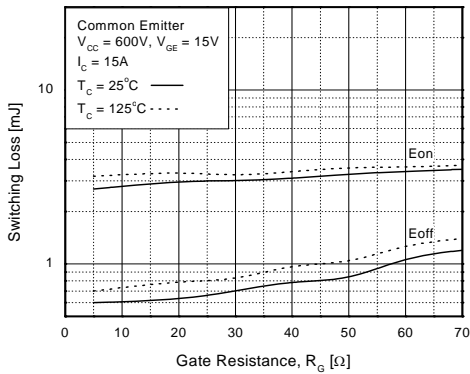
**Figure 7. Turn-On Characteristics vs. Gate Resistance**



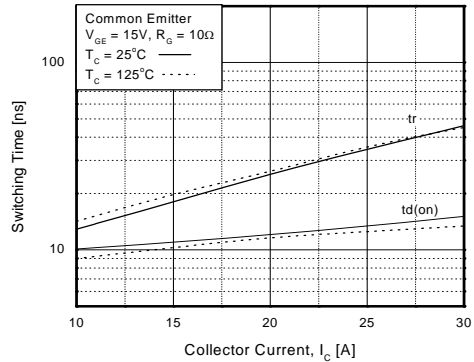
**Figure 8. Turn-Off Characteristics vs. Gate Resistance**



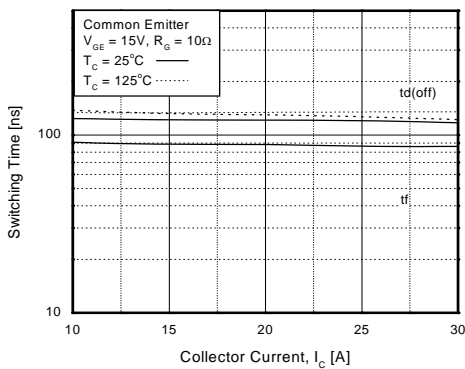
**Figure 9. Switching Loss vs. Gate Resistance**



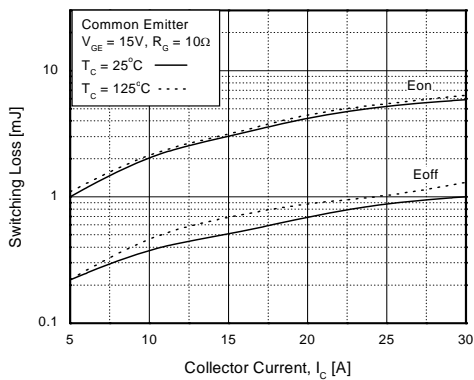
**Figure 10. Turn-On Characteristics vs. Collector Current**



**Figure 11. Turn-Off Characteristics vs. Collector Current**

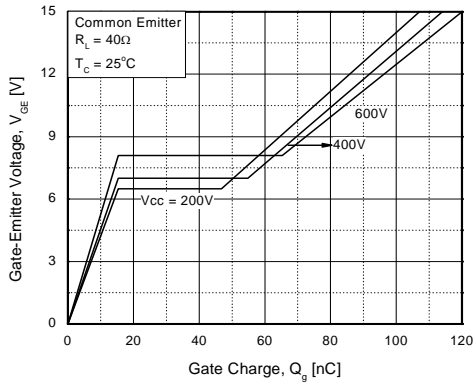


**Figure 12. Switching Loss vs. Collector Current**

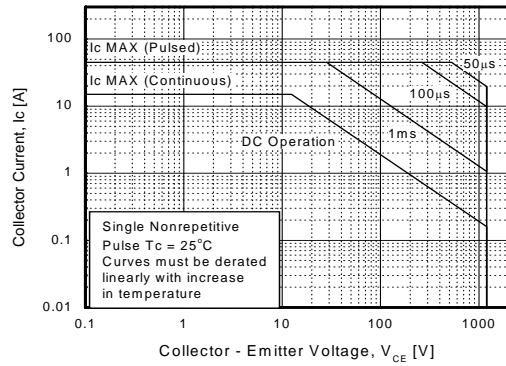


**Typical Performance Characteristics** (Continued)

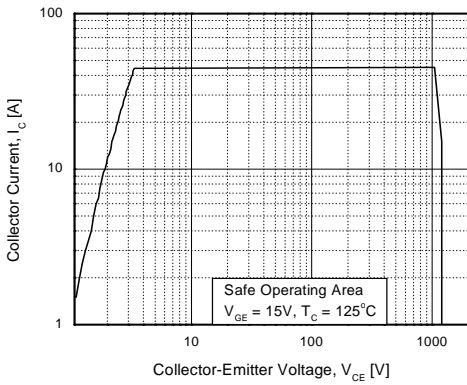
**Figure 13. Gate Charge Characteristics**



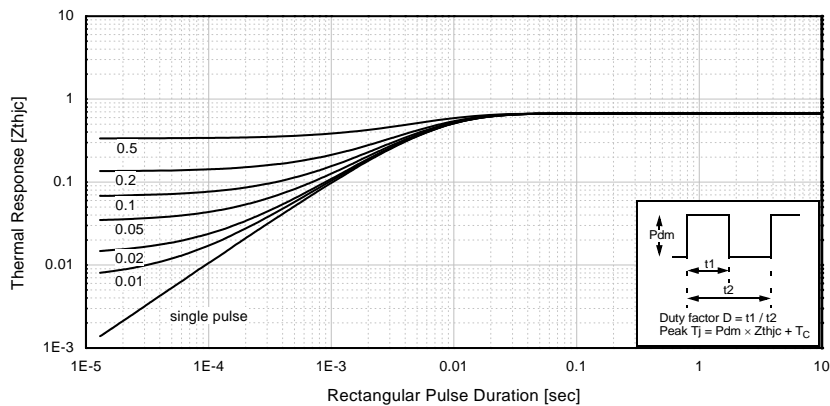
**Figure 14. SOA Characteristics**



**Figure 15. Turn-Off SOA**

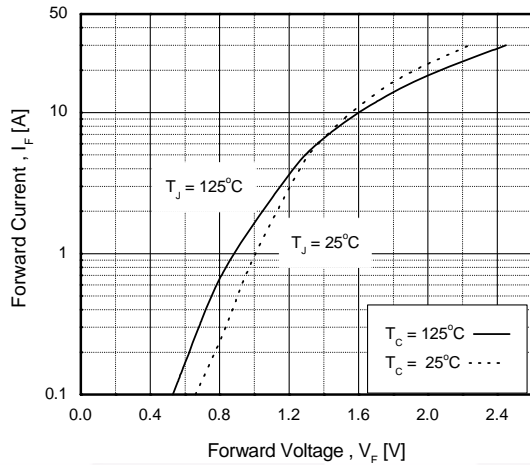


**Figure 16. Transient Thermal Impedance of IGBT**

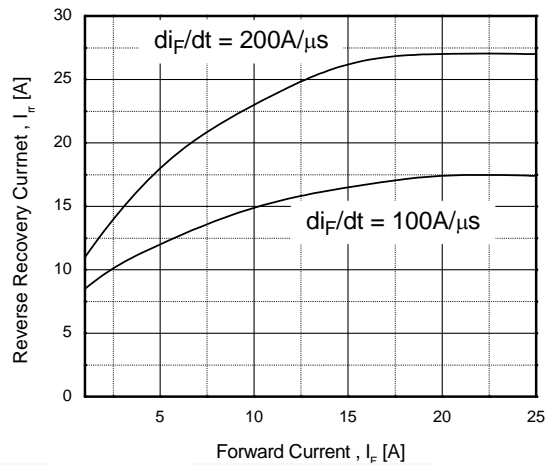


**Typical Performance Characteristics** (Continued)

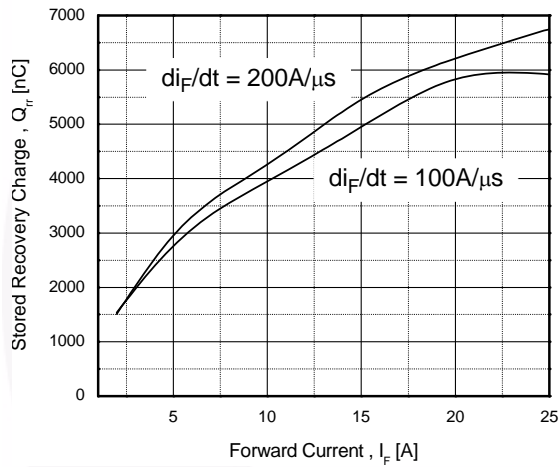
**Figure 17. Forward Characteristics**



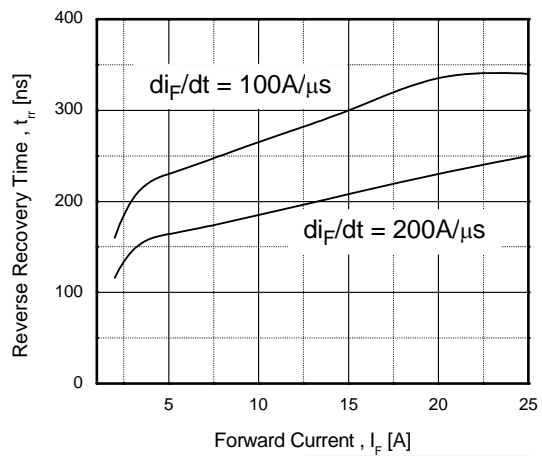
**Figure 18. Reverse Recovery Current**



**Figure 19. Stored Charge**



**Figure 20. Reverse Recovery Time**









ON Semiconductor and  are trademarks of Semiconductor Components Industries, LLC dba ON Semiconductor or its subsidiaries in the United States and/or other countries. ON Semiconductor owns the rights to a number of patents, trademarks, copyrights, trade secrets, and other intellectual property. A listing of ON Semiconductor's product/patent coverage may be accessed at [www.onsemi.com/site/pdf/Patent-Marking.pdf](http://www.onsemi.com/site/pdf/Patent-Marking.pdf). ON Semiconductor reserves the right to make changes without further notice to any products herein. ON Semiconductor makes no warranty, representation or guarantee regarding the suitability of its products for any particular purpose, nor does ON Semiconductor assume any liability arising out of the application or use of any product or circuit, and specifically disclaims any and all liability, including without limitation special, consequential or incidental damages. Buyer is responsible for its products and applications using ON Semiconductor products, including compliance with all laws, regulations and safety requirements or standards, regardless of any support or applications information provided by ON Semiconductor. "Typical" parameters which may be provided in ON Semiconductor data sheets and/or specifications can and do vary in different applications and actual performance may vary over time. All operating parameters, including "Typicals" must be validated for each customer application by customer's technical experts. ON Semiconductor does not convey any license under its patent rights nor the rights of others. ON Semiconductor products are not designed, intended, or authorized for use as a critical component in life support systems or any FDA Class 3 medical devices or medical devices with a same or similar classification in a foreign jurisdiction or any devices intended for implantation in the human body. Should Buyer purchase or use ON Semiconductor products for any such unintended or unauthorized application, Buyer shall indemnify and hold ON Semiconductor and its officers, employees, subsidiaries, affiliates, and distributors harmless against all claims, costs, damages, and expenses, and reasonable attorney fees arising out of, directly or indirectly, any claim of personal injury or death associated with such unintended or unauthorized use, even if such claim alleges that ON Semiconductor was negligent regarding the design or manufacture of the part. ON Semiconductor is an Equal Opportunity/Affirmative Action Employer. This literature is subject to all applicable copyright laws and is not for resale in any manner.

## PUBLICATION ORDERING INFORMATION

### LITERATURE FULFILLMENT:

Literature Distribution Center for ON Semiconductor  
19521 E. 32nd Pkwy, Aurora, Colorado 80011 USA  
**Phone:** 303-675-2175 or 800-344-3860 Toll Free USA/Canada  
**Fax:** 303-675-2176 or 800-344-3867 Toll Free USA/Canada  
**Email:** [orderlit@onsemi.com](mailto:orderlit@onsemi.com)

**N. American Technical Support:** 800-282-9855 Toll Free  
USA/Canada  
**Europe, Middle East and Africa Technical Support:**  
Phone: 421 33 790 2910  
**Japan Customer Focus Center**  
Phone: 81-3-5817-1050

**ON Semiconductor Website:** [www.onsemi.com](http://www.onsemi.com)  
**Order Literature:** <http://www.onsemi.com/orderlit>  
For additional information, please contact your local  
Sales Representative

## X-ON Electronics

Largest Supplier of Electrical and Electronic Components

*Click to view similar products for [IGBT Transistors](#) category:*

*Click to view products by [ON Semiconductor](#) manufacturer:*

Other Similar products are found below :

[748152A](#) [FGH60T65SHD\\_F155](#) [APT100GT60B2RG](#) [APT13GP120BG](#) [APT20GN60BG](#) [APT20GT60BRDQ1G](#) [APT25GN120B2DQ2G](#)  
[APT35GA90BD15](#) [APT36GA60BD15](#) [APT40GP60B2DQ2G](#) [APT40GP90B2DQ2G](#) [APT50GN120B2G](#) [APT50GT60BRG](#)  
[APT64GA90B2D30](#) [APT70GR120J](#) [NGTB10N60FG](#) [NGTB30N60L2WG](#) [NGTG25N120FL2WG](#) [IGP30N60H3XKSA1](#)  
[IGW40N60H3FKSA1](#) [STGB15H60DF](#) [STGFW20V60DF](#) [STGFW30V60DF](#) [STGFW40V60F](#) [STGWA25H120DF2](#) [FGB3236\\_F085](#)  
[APT25GN120BG](#) [APT25GR120S](#) [APT30GN60BDQ2G](#) [APT30GN60BG](#) [APT30GP60BG](#) [APT30GS60BRDQ2G](#) [APT30N60BC6](#)  
[APT35GP120JDQ2](#) [APT36GA60B](#) [APT45GR65B2DU30](#) [APT50GP60B2DQ2G](#) [APT68GA60B](#) [APT70GR65B](#) [APT70GR65B2SCD30](#)  
[GT50JR22\(STA1ES\)](#) [TIG058E8-TL-H](#) [IDW40E65D2](#) [NGTB50N60L2WG](#) [STGB10H60DF](#) [STGB20V60F](#) [STGB40V60F](#) [STGFW80V60F](#)  
[IGW40N120H3FKSA1](#) [RJH60D7BDPQ-E0#T2](#)