

# Lithium-Ion Linear Battery Charger with Thermistor Interface

## FEATURES

- Complete Standalone Linear Charger Controller for 1-Cell Lithium-Ion Batteries
- Thermistor Interface for Battery Temperature Sensing
- Preset Charge Voltage with  $\pm 1\%$  Accuracy
- Programmable Charge Current
- C/10 Charge Current Detection Output
/li>
- Programmable Charge Termination Timer
- Input Supply (Wall Adapter) Detection Output
- 4.5V to 10V Input Voltage Range
- Automatic Sleep Mode When Input Supply is Removed (Only  $5\mu\text{A}$  Battery Drain)
- Automatic Trickle Charging of Low Voltage Cells
- Automatic Battery Recharge
- Battery Insertion Detection
- Space Saving 10-Pin MSOP Package

## APPLICATIONS

- Cellular Phones
- Handheld Computers
- Charging Docks and Cradles

## DESCRIPTION

The LTC<sup>®</sup>4050-4.1/LTC4050-4.2 are complete standalone constant-current/constant-voltage linear charge controllers for lithium-ion (Li-Ion) batteries. Charge current is programmable and final float voltage has  $\pm 1\%$  accuracy.

When the input supply is removed, the LTC4050 automatically enters a low quiescent current sleep mode, dropping the battery drain current to  $5\mu\text{A}$ . An internal comparator detects the near-end-of-charge (C/10) condition while a programmable timer, using an external capacitor, sets the total charge time. Fully discharged cells are automatically trickle charged at 10% of the programmed current until cell voltage exceeds 2.49V. The thermistor interface suspends charging if the cell temperature is outside of a  $0^\circ\text{C}$  to  $50^\circ\text{C}$  temperature window.

The LTC4050 begins a new charge cycle when a discharged battery is connected to the charger or when the input power is applied. In addition, a new charge cycle is automatically started if the battery remains connected to the charger and the cell voltage drops below 3.88V for 4.1V cells or below 3.98V for 4.2V cells.

The LTC4050 is available in the 10-pin MSOP package.

LT, LTC and LT are registered trademarks of Linear Technology Corporation.

## TYPICAL APPLICATION

Single Cell 4.2V 500mA Li-Ion Battery Charger

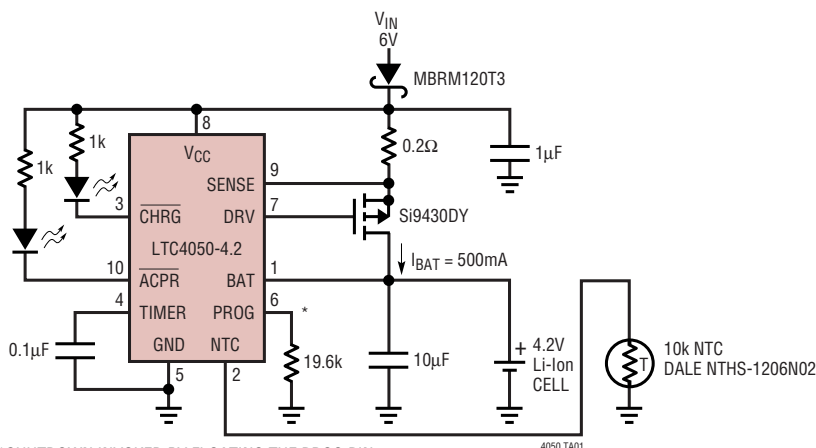

\*SHUTDOWN INVOKED BY FLOATING THE PROG PIN

4050 TA01

Charge Current vs Thermistor Temperature

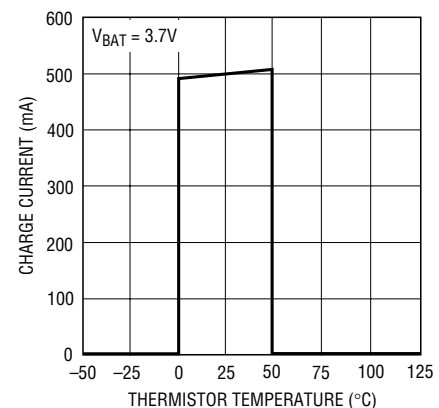

4050 TA05

4050f

# LTC4050

## ABSOLUTE MAXIMUM RATINGS

(Note 1)

Input Supply Voltage ( $V_{CC}$ ) ..... 12V  
 SENSE, DRV, BAT, SEL,  
 TIMER, PROG, CHRG, ACPR ..... -0.3V to 12V  
 Operating Temperature Range (Note 2) . -40°C to 85°C  
 Storage Temperature Range ..... -65°C to 150°C  
 Lead Temperature (Soldering, 10 sec) ..... 300°C

## PACKAGE/ORDER INFORMATION

	ORDER PART NUMBER
	LTC4050EMS-4.1 LTC4050EMS-4.2
	MS PART MARKING
	LTTW LTTX

Consult LTC Marketing for parts specified with wider operating temperature ranges.

## ELECTRICAL CHARACTERISTICS

The ● denotes the specifications which apply over the full operating temperature range, otherwise specifications are at  $T_A = 25^\circ\text{C}$ .  $V_{CC} = 6\text{V}$  unless otherwise noted.

SYMBOL	PARAMETER	CONDITIONS	MIN	TYP	MAX	UNITS	
$V_{CC}$	Input Supply Voltage		● 4.5		10	V	
$I_{CC}$	Input Supply Current	Charger On, Current Mode	●	1.3	3	mA	
		Shutdown Mode	●	1.3	3	mA	
		Sleep Mode (Battery Drain Current)		5	15	μA	
$V_{BAT}$	Regulated Output (Float) Voltage in Constant Voltage Mode	LTC4050-4.1; $5\text{V} \leq V_{CC} \leq 10\text{V}$ , $0^\circ\text{C} \leq T_A \leq 85^\circ\text{C}$		4.059	4.1	4.141	V
		LTC4050-4.2; $5\text{V} \leq V_{CC} \leq 10\text{V}$ , $0^\circ\text{C} \leq T_A \leq 85^\circ\text{C}$		4.158	4.2	4.242	V
		LTC4050-4.1; $5\text{V} \leq V_{CC} \leq 10\text{V}$	●	4.039	4.1	4.141	V
		LTC4050-4.2; $5\text{V} \leq V_{CC} \leq 10\text{V}$	●	4.137	4.2	4.242	V
$I_{BAT}$	Current Mode Charge Current	$R_{PROG} = 19.6\text{k}$ , $R_{SENSE} = 0.2\Omega$		440	500	535	mA
		$R_{PROG} = 19.6\text{k}$ , $R_{SENSE} = 0.2\Omega$	●	415		585	mA
		$R_{PROG} = 97.6\text{k}$ , $R_{SENSE} = 0.2\Omega$		60	100	140	mA
$I_{TRIKL}$	Trickle Charge Current	$V_{BAT} = 2\text{V}$ , $R_{PROG} = 19.6\text{k}$ , $I_{TRIKL} = (V_{CC} - V_{SENSE})/0.2\Omega$	●	20	55	90	mA
$V_{TRIKL}$	Trickle Charge Threshold Voltage		●	2.41	2.49	2.58	V
$V_{UV}$	$V_{CC}$ Undervoltage Lockout Voltage		●	4	4.5	V	
$\Delta V_{UV}$	$V_{CC}$ Undervoltage Lockout Hysteresis			130		mV	
$V_{MSD}$	PROG Pin Manual Shutdown Threshold Voltage			3.6		V	
$V_{ASD}$	Automatic Shutdown Threshold Voltage	$(V_{CC} - V_{BAT})$ High to Low		25	54	85	mV
		$(V_{CC} - V_{BAT})$ Low to High		40	69	100	mV
$I_{PROG}$	PROG Pin Current	Internal Pull-Up Current, No $R_{PROG}$ PROG Pin Source Current, $\Delta V_{PROG} \leq 5\text{mV}$	●	300	2.3	μA	
$V_{PROG}$	PROG Pin Voltage	$R_{PROG} = 19.6\text{k}$		2.47		V	
$V_{ACPR}$	ACPR Pin Output Low Voltage	$I_{ACPR} = 5\text{mA}$		0.525		V	
$I_{CHRG}$	CHRG Pin Weak Pull-Down Current	$V_{CHRG} = 1\text{V}$		32		μA	
$V_{CHRG}$	CHRG Pin Output Low Voltage	$I_{CHRG} = 5\text{mA}$		0.525		V	
$R_{HOT}$	Thermistor Resistance for Hot Fault			3.7	4.1	4.4	kΩ
$R_{COLD}$	Thermistor Resistance for Cold Fault			25	28.5	31	kΩ

4050f

## ELECTRICAL CHARACTERISTICS

The ● denotes the specifications which apply over the full operating temperature range, otherwise specifications are at  $T_A = 25^\circ\text{C}$ .  $V_{CC} = 6\text{V}$  unless otherwise noted.

SYMBOL	PARAMETER	CONDITIONS	MIN	TYP	MAX	UNITS
$I_{C/10}$	10% Charge Current Indication Level	$R_{PROG} = 19.6\text{k}$ , $R_{SENSE} = 0.2\Omega$	● 25	50	100	mA
$t_{TIMER}$	TIMER Accuracy	$C_{TIMER} = 0.1\mu\text{F}$		10		%
$V_{RECHRG}$	Recharge Threshold Voltage	$V_{BAT}$ from High to Low (LTC4050-4.1)	3.83	3.88		V
		$V_{BAT}$ from High to Low (LTC4050-4.2)	3.93	3.98		V

**Note 1:** Absolute Maximum Ratings are those values beyond which the life of a device may be impaired.

**Note 2:** The LTC4050E is guaranteed to meet performance specifications from  $0^\circ\text{C}$  to  $70^\circ\text{C}$ . Specifications over the  $-40^\circ\text{C}$  to  $85^\circ\text{C}$  operating temperature range are assured by design, characterization and correlation with statistical process controls.

## TYPICAL PERFORMANCE CHARACTERISTICS

Charge Current vs Temperature

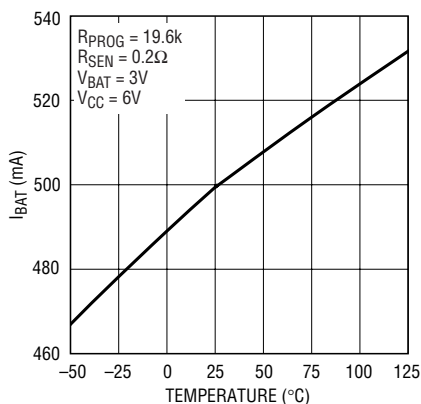

LTC4050 G01

Charge Current vs  $V_{CC}$

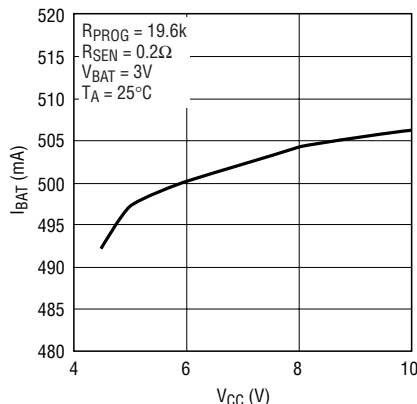

LTC4050 G02

Trickle Charge Current vs Temperature

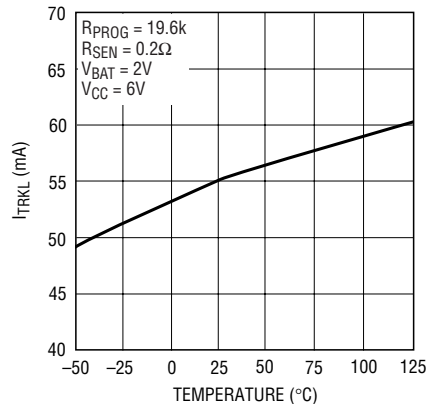

LTC4050 G03

Trickle Charge Current vs  $V_{CC}$

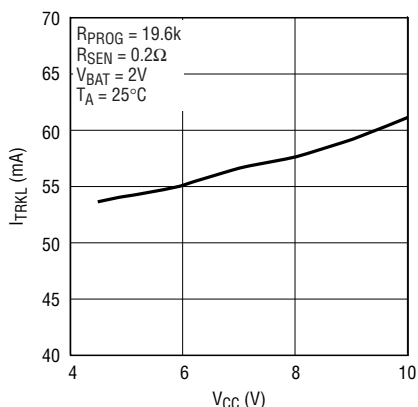

LTC4050 G04

Trickle Charge Threshold Voltage vs Temperature

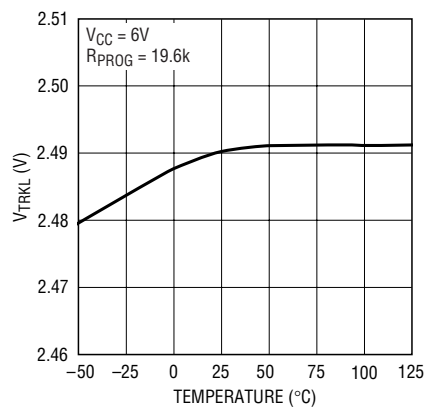

LTC4050 G05

Trickle Charge Threshold Voltage vs  $V_{CC}$

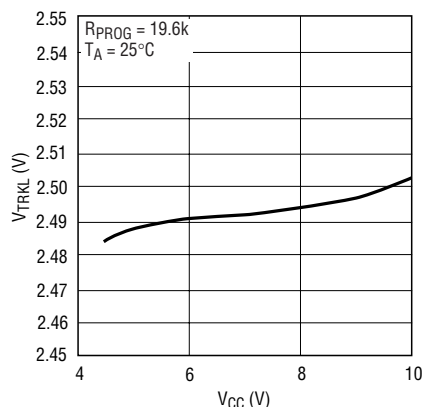

LTC4050 G06

## TYPICAL PERFORMANCE CHARACTERISTICS

**Recharge Threshold Voltage vs Temperature**

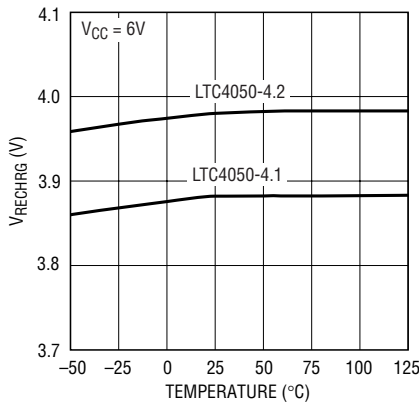

LTC4050 G07

**PROG Pin Voltage vs Temperature**

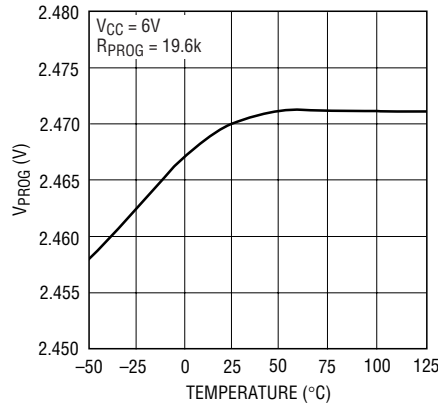

LTC4050 G08

**PROG Pin Voltage vs  $V_{CC}$**

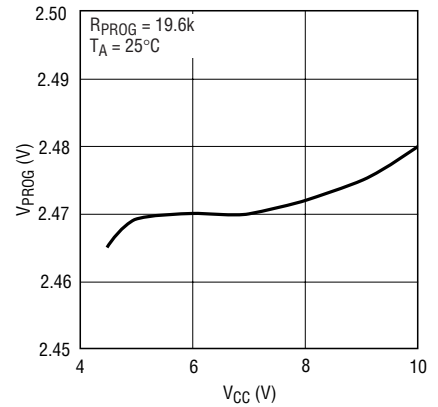

LTC4050 G09

**Timer Accuracy vs Temperature**

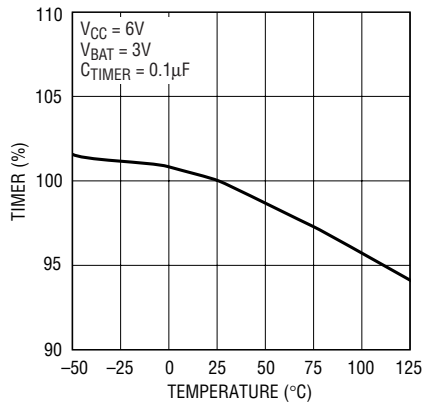

LTC4050 G10

**Timer Accuracy vs  $V_{CC}$**

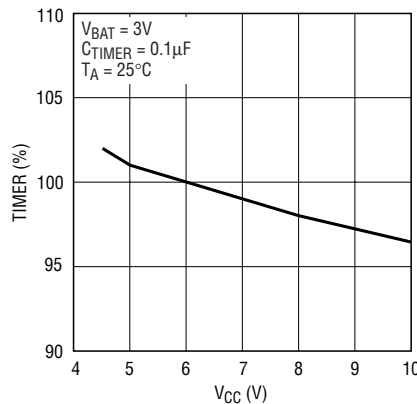

LTC4050 G11

**NTC  $R_{HOT}$  Threshold Voltage vs Temperature**

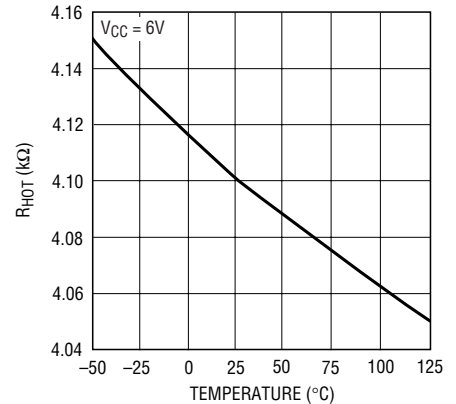

LTC4050 G12

**NTC  $R_{COLD}$  Threshold Voltage vs Temperature**

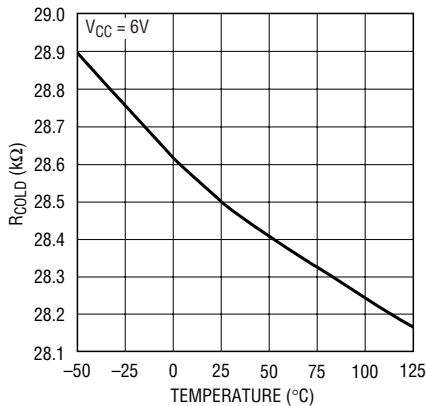

LTC4050 G13

**NTC  $R_{HOT}$  Threshold Voltage vs  $V_{CC}$**

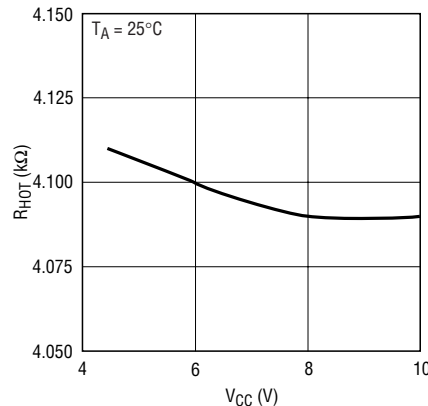

LTC4050 G14

**NTC  $R_{COLD}$  Threshold Voltage vs  $V_{CC}$**

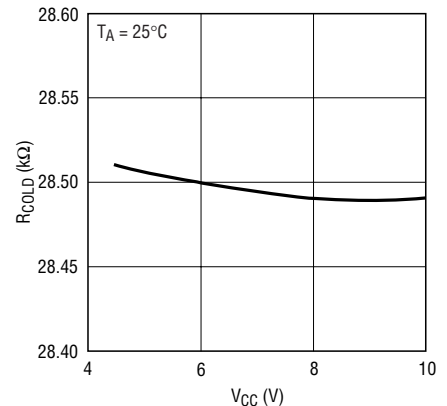

LTC4050 G15

## PIN FUNCTIONS

**BAT (Pin 1):** Battery Sense Input. A precision internal resistor divider on this pin sets the final float voltage. The resistor divider is disconnected in sleep mode to reduce the current drain on the battery. A bypass capacitor of 10 $\mu$ F or more is required to keep the loop stable when the battery is not connected.

**NTC (Pin 2):** Thermistor Interface Input. A 10k $\Omega$  Dale Curve 2 NTC thermistor (or other 10k $\Omega$  NTC thermistor with a room temperature beta of around 3400) is connected from this pin to ground. The charge cycle will be disabled and the timer will be placed on hold if the thermistor temperature is above 50°C or below 0°C.

**CHRG (Pin 3):** Charge Status Open-Drain Output. When the battery is charging, the CHRG pin is pulled low by an internal N-channel MOSFET. When the charge current drops to 10% of the full-scale current for more than 15ms, the N-channel MOSFET turns off and a 32 $\mu$ A current source is connected from the CHRG pin to GND. When the timer runs out or the input supply is removed, the current source is disconnected and the CHRG pin becomes high impedance.

**TIMER (Pin 4):** Timer Capacitor and Constant-Voltage Mode Disable Input Pin. The timer period is set by placing a capacitor, C<sub>TIMER</sub>, to GND. The timer period is  $t_{\text{TIMER}} = (C_{\text{TIMER}} \cdot 3 \text{ hours}) / (0.1 \mu\text{F})$ . Shorting the TIMER pin to GND will disable the internal timer function and the C/10 function.

**GND (Pin 5):** Ground.

**PROG (Pin 6):** Charge Current Program and Shutdown Input Pin. The charge current is programmed by connecting a resistor, R<sub>PROG</sub> to ground. The charge current is  $I_{\text{BAT}} = (V_{\text{PROG}} \cdot 800\Omega) / (R_{\text{PROG}} \cdot R_{\text{SENSE}})$ . The IC can be forced into shutdown by floating the PROG pin and allowing the internal 2.3 $\mu$ A current source to pull the pin above the 3.6V shutdown threshold voltage.

**DRV (Pin 7):** Drive Output Pin for the P-Channel MOSFET or PNP Transistor. The impedance is high at this pin, therefore, if a PNP pass transistor is used, it must have high gain.

**V<sub>CC</sub> (Pin 8):** Positive Input Supply Voltage. V<sub>CC</sub> can range from 4.5V to 10V. Bypass this pin with a 1 $\mu$ F capacitor. When V<sub>BAT</sub> is within 54mV of V<sub>CC</sub>, the LTC4050 is forced into sleep mode, dropping I<sub>CC</sub> to 5 $\mu$ A.

**SENSE (Pin 9):** Current Sense Input. A sense resistor, R<sub>SENSE</sub>, must be connected from V<sub>CC</sub> to the SENSE pin. Select a resistor value that will develop approximately 100mV at the programmed full-scale charge current. This resistor is chosen using the following equation:

$$R_{\text{SENSE}} = (V_{\text{PROG}} \cdot 800\Omega) / (R_{\text{PROG}} \cdot I_{\text{BAT}})$$

**ACPR (Pin 10):** Wall Adapter Present Output. When the input voltage (wall adaptor) is applied to the LTC4050, this pin is pulled to ground by an internal N-channel MOSFET that is capable of sinking 5mA suitable for driving an external LED.

# LTC4050

## BLOCK DIAGRAM

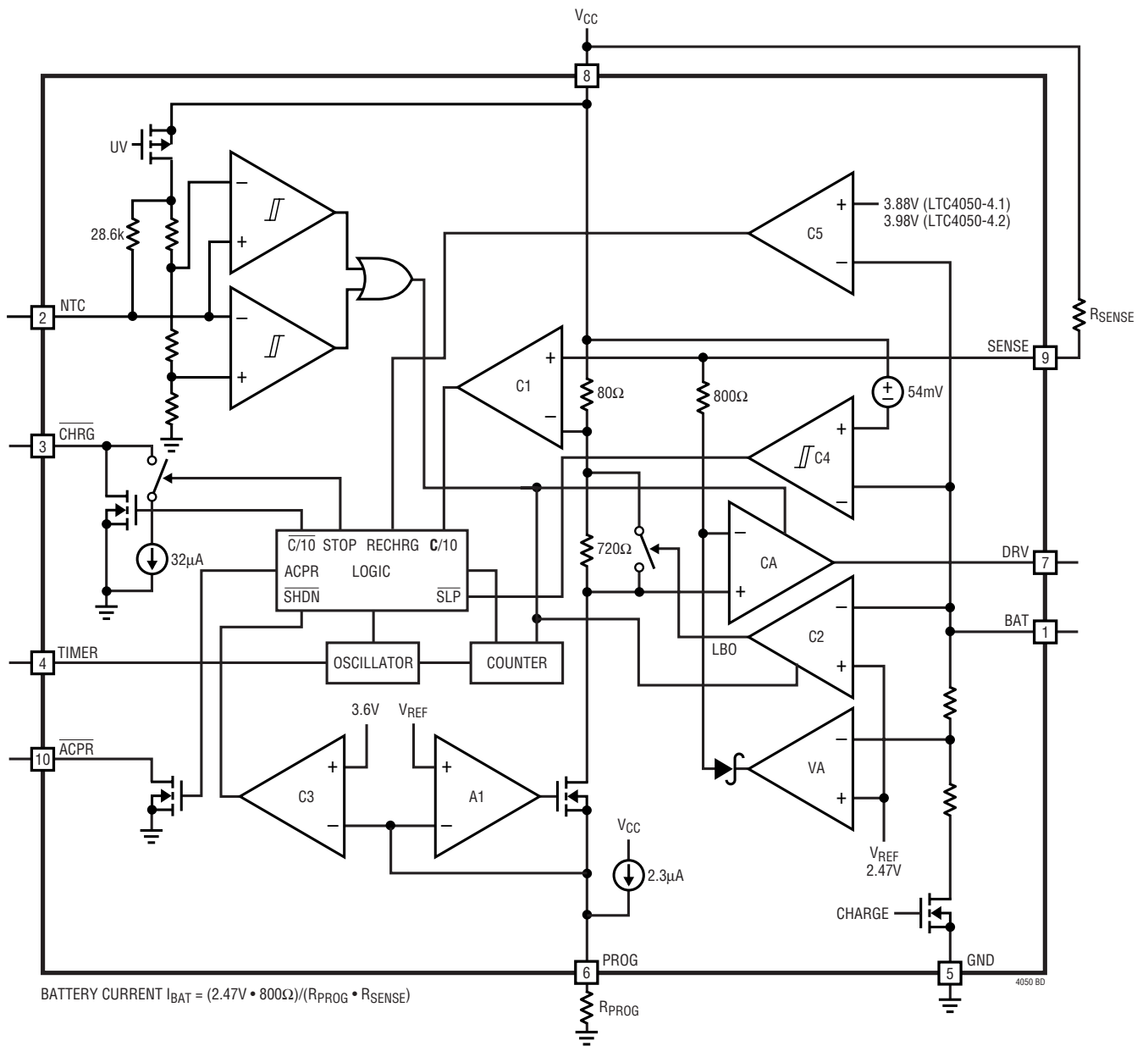

## OPERATION

The LTC4050 is a linear battery charger controller. The charge current is programmed by the combination of a program resistor ( $R_{\text{PROG}}$ ) from the PROG pin to ground and a sense resistor ( $R_{\text{SENSE}}$ ) between the  $V_{\text{CC}}$  and SENSE pins.  $R_{\text{PROG}}$  sets a program current through an internal trimmed  $800\Omega$  resistor setting up a voltage drop from  $V_{\text{CC}}$  to the input of the current amplifier (CA). The current amplifier servos the gate of the external P-channel MOSFET to force the same voltage drop across  $R_{\text{SENSE}}$  which sets the charge current. When the voltage at the BAT pin approaches the preset float voltage, the voltage amplifier (VA) will start sinking current which reduces the voltage drop across  $R_{\text{SENSE}}$ , thus reducing the charge current.

A charge cycle begins when the voltage at  $V_{\text{CC}}$  pin rises above the UVLO level, a program resistor is connected from the PROG pin to ground, and the NTC thermistor temperature is between  $0^{\circ}\text{C}$  and  $50^{\circ}\text{C}$ . At the beginning of the charge cycle, if the battery voltage is below 2.49V, the charger goes into trickle charge mode. The trickle charge current is 10% of the full-scale current. If the cell voltage stays low for one quarter of the total charge time, the charge sequence will terminate.

The charger goes into the fast charge constant-current mode after the voltage on the BAT pin rises above 2.49V. In constant-current mode, the charge current is set by the combination of  $R_{\text{SENSE}}$  and  $R_{\text{PROG}}$ .

When the battery approaches the final float voltage, the charge current will begin to decrease. When the current drops to 10% of the full-scale charge current, an internal comparator will turn off the pull-down N-channel MOSFET

at the  $\overline{\text{CHRG}}$  pin and connect a weak current source to ground, indicating that the battery is nearly fully charged ( $C/10$  occurs at approximately 94% charge).

An external capacitor on the TIMER pin sets the total charge time. After a time-out occurs, the charge cycle is terminated and the CHRG pin is forced high impedance. To restart the charge cycle, remove the input voltage and reapply it, or momentarily float the PROG pin.

Replacing the battery when charging will cause the timer to be reset if the cell voltage of the new battery is below 3.88V (for 4.1V cells) or 3.98V (for 4.2V cells). If the voltage is above 3.88V (for 4.1V cells) or 3.98V (for 4.2V cells) the timer will continue for the remaining charge time. In the case when a time out has occurred, a new battery with a cell voltage of less than 3.88V or 3.98V can be inserted and charged automatically with the full programmed charge time.

For batteries like lithium-ion that require accurate final float voltage, the internal 2.47V reference, voltage amplifier and the resistor divider provide regulation with  $\pm 1\%$  (max) accuracy.

The charger can be shut down by floating the PROG pin. An internal current source will pull it high and clamp at 3.5V.

When the input voltage is not present, the charger goes into a sleep mode, dropping  $I_{\text{CC}}$  to  $5\mu\text{A}$ . This greatly reduces the current drain on the battery and increases the standby time.

## APPLICATIONS INFORMATION

### Charger Conditions

The charger is off when any of the following conditions exist: the voltage at the  $V_{CC}$  pin is below 4V, the voltage at the  $V_{CC}$  pin is greater than 4V but is less than 54mV above  $V_{BAT}$ , the PROG pin is floating, the timer has timed out or the thermistor temperature is outside the acceptable range. In this condition, the DRV pin is pulled to  $V_{CC}$  and the internal resistor divider is disconnected to reduce the current drain on the battery.

### Undervoltage Lockout (UVLO)

An internal undervoltage lockout circuit monitors the input voltage and keeps the charger in shutdown mode until  $V_{CC}$  rises above the undervoltage lockout threshold of 4V. To prevent oscillation around  $V_{CC} = 4V$ , the UVLO circuit has built-in hysteresis.

### Trickle Charge and Defective Battery Detection

At the beginning of the charging sequence, if the battery voltage is low (below 2.49V), the charger goes into trickle mode. In this mode, the charge current is reduced to 10% of the full-scale current. If the low cell voltage persists for one quarter of the total charge time, the battery is considered defective, the charge cycle is terminated and the CHRG pin output becomes high impedance.

### Shutdown

The LTC4050 can be forced into shutdown by floating the PROG pin and allowing the internal 2.3 $\mu$ A current source to pull the pin above the 3.6V shutdown threshold voltage. In shutdown, the DRV pin is pulled up to  $V_{CC}$ , turning off the external P-channel MOSFET and resetting the internal timer.

### Programming Charge Current

The formula for the battery charge current (see Block Diagram) is:

$$I_{BAT} = (I_{PROG})(800\Omega/R_{SENSE}) \\ = (2.47V/R_{PROG})(800\Omega/R_{SENSE}) \text{ or}$$

$$R_{PROG} = (2.47V/I_{BAT})(800\Omega/R_{SENSE})$$

where  $R_{PROG}$  is the total resistance from the PROG pin to ground.

For example, if 0.5A charge current is needed, select a value for  $R_{SENSE}$  that will drop 100mV at the maximum charge current.  $R_{SENSE} = 0.1V/0.5A = 0.2\Omega$ , then calculate:

$$R_{PROG} = (2.47V/500mA)(800\Omega/0.2\Omega) = 19.76k$$

For best stability over temperature and time, 1% resistors are recommended. The closest 1% resistor value is 19.6k.

### Programming the Timer

The programmable timer terminates the charge cycle. Typically when charging at a 1C rate, a discharged Li-Ion battery will become fully charged in 3 hours. For lower charge current rates, extend the time accordingly. The length of the timer is programmed by an external capacitor at the TIMER pin. The total charge time is:

$$\text{Time (Hours)} = (3 \text{ Hours}) \cdot (C_{TIMER}/0.1\mu\text{F}) \text{ or}$$

$$C_{TIMER} = 0.1\mu\text{F} \cdot \text{Time (Hours)}/3 \text{ Hours}$$

The timer starts when an input voltage greater than 4V is applied and the program resistor is connected to ground. After a time-out occurs, the CHRG output will go high impedance to indicate that charging has stopped. To disable the timer function, short the TIMER pin to GND.

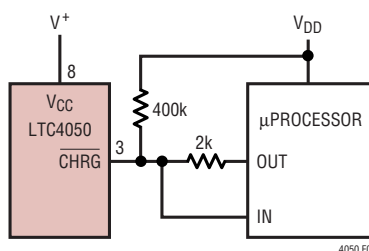

Figure 1. Microprocessor Interface



## APPLICATIONS INFORMATION

### CHRG Status Output Pin (C/10)

When the charge cycle starts, the  $\overline{\text{CHRG}}$  pin is pulled to ground by an internal N-channel MOSFET that can drive an LED. When the charge current drops to 10% of the full-scale current (C/10), the N-channel MOSFET turns off and a weak  $32\mu\text{A}$  current source to ground is connected to the  $\overline{\text{CHRG}}$  pin. After a time-out occurs, the pin goes high impedance. By using two different value pull-up resistors, a microprocessor can detect three states from this pin (charging, C/10 and stop charging). See Figure 1.

When the LTC4050 is in charge mode, the  $\overline{\text{CHRG}}$  pin is pulled low by an internal N-channel MOSFET. To detect this mode, force the digital output pin, OUT, high and measure the voltage at the  $\overline{\text{CHRG}}$  pin. The N-channel MOSFET will pull the pin low even with a 2k pull-up resistor. Once the charge current drops to 10% of the full-scale current (C/10), the N-channel MOSFET turns off and a  $32\mu\text{A}$  current source is connected to the  $\overline{\text{CHRG}}$  pin. The IN pin will then be pulled high by the 2k pull-up. By forcing the OUT pin into a high impedance state, the current source will pull the pin low through the 400k resistor. When the internal timer has expired, the  $\overline{\text{CHRG}}$  pin will change to high impedance state and the 400k resistor will then pull the pin high to indicate charging has stopped.

The  $\overline{\text{CHRG}}$  pin open-drain device will turn on if the BAT pin falls below the trickle charge threshold and the LTC4050 has neither timed out nor been put into shutdown. For example, if the battery and NTC thermistor are both disconnected from the typical application circuit, the BAT voltage will collapse due to the thermal fault and  $\overline{\text{CHRG}}$  will pull low. Entering shutdown by floating the PROG pin will prevent the  $\overline{\text{CHRG}}$  pulldown from turning on.

### ACPR Output Pin

The LTC4050 has an  $\overline{\text{ACPR}}$  output pin to indicate that the input supply (wall adapter) is higher than 4V and 54mV or more above the voltage at the BAT pin. When both conditions are met, the  $\overline{\text{ACPR}}$  pin is pulled to ground by an

N-channel MOSFET that is capable of driving an LED. Otherwise, this pin is in a high impedance state.

### Gate Drive

Typically the LTC4050 controls an external P-channel MOSFET to supply current to the battery. An external PNP transistor can also be used as the pass transistor instead of the P-channel MOSFET. Due to the low current gain of the current amplifier (CA), a high gain Darlington PNP transistor is recommended to avoid excessive charge current error. The gain of the current amplifier is around  $0.6\mu\text{A}/\text{mV}$ . For every  $1\mu\text{A}$  of base current, a 1.6mV of gain error shows up at the inputs of CA. With  $R_{\text{PROG}} = 19.6\text{k}$  (100mV across  $R_{\text{SENSE}}$ ), it represents 1.67% of error in charge current.

### Battery Detection

The LTC4050 can detect the insertion of a new battery. When a battery with a voltage of less than 3.88V (for 4.1V cells) or 3.98V (for 4.2V cells) is inserted, the LTC4050 resets the timer and starts a new charge cycle. If the cell voltage of the new battery is above 3.88V (for 4.1V cells) or 3.98V (for 4.2V cells), a new charge cycle will not begin. If a new battery (with cell voltage above 3.88V) is inserted while in the charging process, the timer will not be reset, but will continue until the timer runs out.

After a time out has occurred and the battery remains connected, a new charge cycle will begin if the battery voltage drops below the recharge threshold of 3.88V (for 4.1V cells) or 3.98V (for 4.2V cells) due to self-discharge or external loading.

### Stability

The charger is stable without any compensation when a P-channel MOSFET is used as the pass transistor. However, a  $10\mu\text{F}$  capacitor is recommended at the BAT pin to keep the ripple voltage low when the battery is disconnected.

## APPLICATIONS INFORMATION

If a PNP transistor is chosen as the pass transistor, a 1000pF capacitor is required from the DRV pin to  $V_{CC}$ . This capacitor is needed to help stabilize the voltage loop. A 10 $\mu$ F capacitor at the BAT pin is also recommended when a battery is not present.

### $V_{CC}$ Bypass Capacitor

Many types of capacitors can be used for input bypassing. However, caution must be exercised when using multi-layer ceramic capacitors. Because of the self resonant and high Q characteristics of some types of ceramic capacitors, high voltage transients can be generated under some start-up conditions, such as connecting the charger input to a hot power source. These transients can be minimized by using X5R dielectric capacitors and/or by adding a 1.5 $\Omega$  resistor in series with the ceramic input capacitor. For more information, refer to Application Note 88.

### Thermistor Interface

A thermistor connected to the NTC (negative temperature coefficient) pin can be used to sense the battery temperature to determine if the battery is within an acceptable temperature range for charging (between 0°C and 50°C). A Dale (curve 2) 10k thermistor is recommended although many other types of thermistors can also be used. For example, a BetaCHIP (curve 7) 10k thermistor or other 10k thermistors with a room temperature beta of approximately 3400 will work well. The thermistor is connected from NTC (pin 2) to ground and is biased up by an internal

28.6k trimmed thin film resistor that connects to  $V_{CC}$  through a P-channel MOSFET. This MOSFET also biases an internal resistor string to ground, from which voltage thresholds of approximately  $V_{CC}/2$  and  $V_{CC}/8$  are derived. The NTC pin is compared to these thresholds by two comparators that have wired-OR outputs. The thresholds are selected such that an overtemperature condition will occur when the thermistor resistance is less than approximately 4.1k and undertemperature condition will occur when the thermistor resistance is greater than approximately 28.5k. These correspond to thermistor temperatures of 50°C and 0°C for the specific type of thermistor listed above (many others will be close enough for most purposes). The MOSFET is turned off during undervoltage conditions, preventing the dividers that are biased from it from drawing current from the battery when input power is removed. The drop across the MOSFET is common to both resistor dividers and does not cause any loss of accuracy in the circuit. The comparators have approximately 10mV of hysteresis to prevent oscillations around the trip points.

When an undertemperature or overtemperature condition is sensed, the current amplifier pulldown is disabled and DRV is pulled high, the timer is placed in a hold condition with the count frozen until the battery temperature is within an acceptable range. The end-of-charge comparator is also disabled to prevent a premature end of charge signal due to the lack of battery charging current.

NTC Interface Circuitry

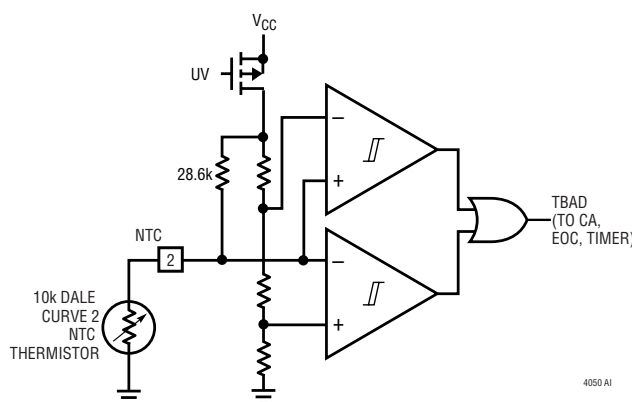

## PACKAGE DESCRIPTION

**MS Package**  
**10-Lead Plastic MSOP**  
 (Reference LTC DWG # 05-08-1661)

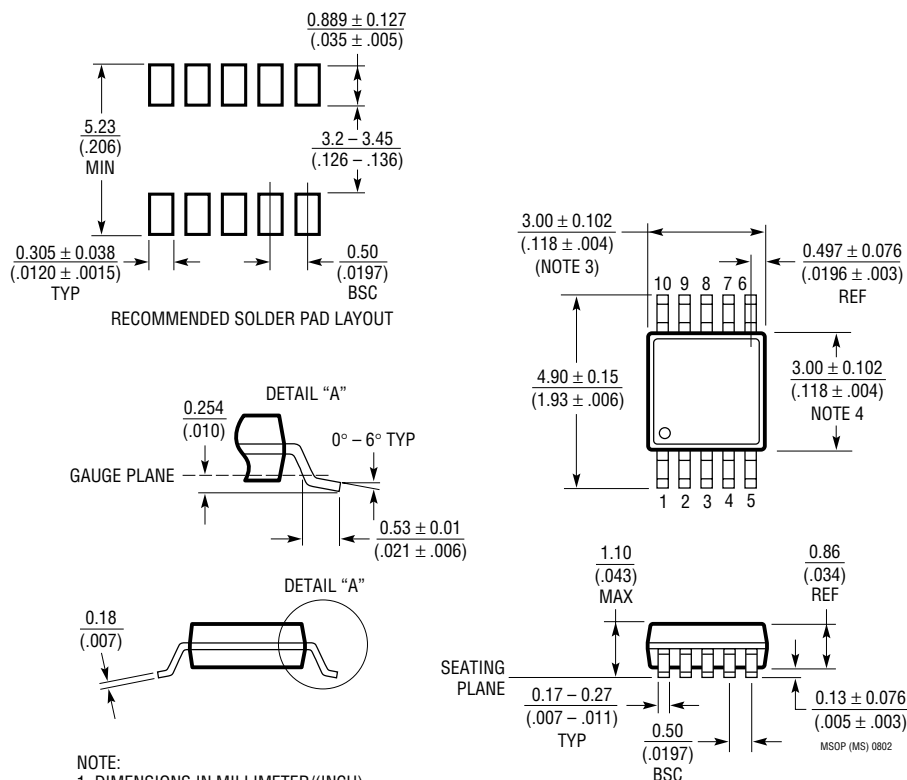

## NOTE:

1. DIMENSIONS IN MILLIMETER/(INCH)
2. DRAWING NOT TO SCALE
3. DIMENSION DOES NOT INCLUDE MOLD FLASH, PROTRUSIONS OR GATE BURRS.  
MOLD FLASH, PROTRUSIONS OR GATE BURRS SHALL NOT EXCEED 0.152mm (.006") PER SIDE
4. DIMENSION DOES NOT INCLUDE INTERLEAD FLASH OR PROTRUSIONS.  
INTERLEAD FLASH OR PROTRUSIONS SHALL NOT EXCEED 0.152mm (.006") PER SIDE
5. LEAD COPLANARITY (BOTTOM OF LEADS AFTER FORMING) SHALL BE 0.102mm (.004") MAX



## X-ON Electronics

Largest Supplier of Electrical and Electronic Components

*Click to view similar products for [Battery Management](#) category:*

*Click to view products by [Linear Technology](#) manufacturer:*

Other Similar products are found below :

[MP2602DQ-LF-P](#) [MP26053DQ-LF-Z](#) [MP2611GL-P](#) [NCP347MTAHTBG](#) [LM3658SD-AEV/NOPB](#) [MP2607DL-LF-P](#) [MP26121DQ-LF-P](#)  
[MP26123DR-LF-P](#) [MP2633GR-P](#) [MP2637GR-P](#) [BQ24212EVM-678](#) [NCP1855FCCT1G](#) [MP2636GR-P](#) [FAN54063UCX](#)  
[MAX14680EWC+T](#) [MAX14634EWC+T](#) [DS2745U+T&R](#) [MAX14578EETE+T](#) [DS2781EVKIT+](#) [DS2781E+T&R](#) [MP2605DQ-LF-P](#)  
[DS2710G+T&R](#) [MAX17040G+T](#) [MAX14525ETA+T](#) [MP2615GQ-P](#) [MAX14578EEWC+T](#) [LC05132C01NMTTTG](#) [MAX8971EWP+T](#)  
[MAX14630EZK+T](#) [MAX1873TEEE+T](#) [PSC5415A](#) [AUR9811DGD](#) [SN2040DSQR](#) [DS2715BZ+T&R](#) [MAX1508ZETA+T](#)  
[MAX14921ECS+T](#) [MAX77301EWA+T](#) [BD8668GW-E2](#) [MAX16024PTBS+T](#) [DS2715Z+T&R](#) [MAX16024LTBZ18+T](#) [DS2782E+T&R](#)  
[DS2782G+T&R](#) [MAX1908ETI+T](#) [ISL95522IRZ](#) [ISL95522HRZ](#) [ARD00558](#) [NCP4371AAEDR2G](#) [BD8665GW-E2](#) [MAX8934EETI+T](#)