

### FEATURES

- isoPower* integrated, isolated dc-to-dc converter
- Regulated 5 V or 3.3 V output
- Up to 400 mW output power
- 16-lead SOIC wide body package (RW-16)
- 16-lead SOIC wide body package with enhanced creepage (RI-16-1)
- Quad dc-to-25 Mbps (NRZ) signal isolation channels
- Schmitt triggered inputs
- High temperature operation: 105°C maximum
- High common-mode transient immunity: >25 kV/μs
- [Safety and regulatory approvals](#) (RI-16-1 package)

#### UL recognition

5000 V rms for 1 minute per UL 1577

#### CSA Component Acceptance Notice #5A (pending)

IEC 60601-1: 250 V rms

IEC 60950-1: 400 V rms

#### VDE certificate of conformity

DIN V VDE V 0884-10 (VDE V 0884-10):2006-12

$V_{IORM} = 846$  V peak

### APPLICATIONS

RS-232/RS-422/RS-485 transceivers

Medical isolation

AC/DC power supply start-up bias and gate drives

Isolated sensor interfaces

### GENERAL DESCRIPTION

The [ADuM6400/ADuM6401/ADuM6402/ADuM6403/ADuM6404](#)<sup>1</sup> are quad-channel digital isolators with *isoPower*®, an integrated, isolated dc-to-dc converter. Based on the Analog Devices, Inc., *iCoupler*® technology, the dc-to-dc converter provides up to 400 mW of regulated, isolated power at either 5.0 V or 3.3 V from a 5.0 V input supply, or at 3.3 V from a 3.3 V supply at the power levels shown in Table 1. These devices eliminate the need for a separate, isolated dc-to-dc converter in low power, isolated designs.

The [ADuM6400/ADuM6401/ADuM6402/ADuM6403/ADuM6404](#) isolators provide four independent isolation channels in a variety of channel configurations and data rates (see the Ordering Guide for more information).

*isoPower* uses high frequency switching elements to transfer power through its transformer. Special care must be taken during printed circuit board (PCB) layout to meet emissions standards. See the [AN-0971 Application Note](#) for board layout recommendations.

<sup>1</sup> Protected by U.S. Patents 5,952,849; 6,873,065; 6,903,578; and 7,075,329.

#### Rev. A

Information furnished by Analog Devices is believed to be accurate and reliable. However, no responsibility is assumed by Analog Devices for its use, nor for any infringements of patents or other rights of third parties that may result from its use. Specifications subject to change without notice. No license is granted by implication or otherwise under any patent or patent rights of Analog Devices. Trademarks and registered trademarks are the property of their respective owners.

### FUNCTIONAL BLOCK DIAGRAMS

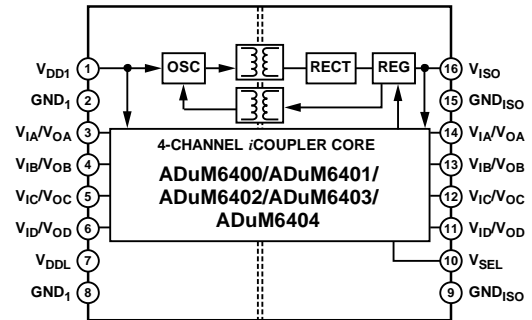

Figure 1.

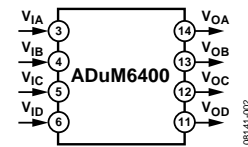

Figure 2. ADuM6400

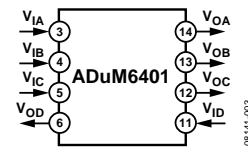

Figure 3. ADuM6401

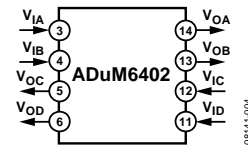

Figure 4. ADuM6402

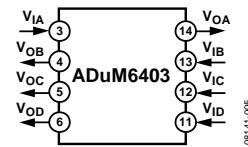

Figure 5. ADuM6403

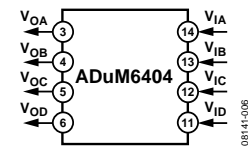

Figure 6. ADuM6404

Table 1. Power Levels

| Input Voltage | Output Voltage | Output Power |
|---------------|----------------|--------------|
| 5.0 V         | 5.0 V          | 400 mW       |
| 5.0 V         | 3.3 V          | 330 mW       |
| 3.3 V         | 3.3 V          | 132 mW       |

## TABLE OF CONTENTS

|   |    |   |    |
|---|----|---|----|
| Features .....  | 1  | Pin Configurations and Function Descriptions .....  | 12 |
| Applications .....  | 1  | Truth Table .....                                   | 16 |
| General Description .....   | 1  | Typical Performance Characteristics .....           | 17 |
| Functional Block Diagrams .....   | 1  | Terminology .....                                   | 20 |
| Revision History .....  | 2  | Applications Information .....                      | 21 |
| Specifications .....  | 3  | PCB Layout .....                                    | 21 |
| Electrical Characteristics—5 V Primary Input Supply/<br>5 V Secondary Isolated Supply .....     | 3  | Start-Up Behavior .....                             | 21 |
| Electrical Characteristics—3.3 V Primary Input Supply/<br>3.3 V Secondary Isolated Supply ..... | 5  | EMI Considerations .....                            | 22 |
| Electrical Characteristics—5 V Primary Input Supply/<br>3.3 V Secondary Isolated Supply .....   | 6  | Propagation Delay Parameters .....                  | 22 |
| Package Characteristics .....   | 8  | DC Correctness and Magnetic Field Immunity .....    | 22 |
| Regulatory Information .....  | 9  | Power Consumption .....                             | 23 |
| Insulation and Safety-Related Specifications .....  | 9  | Current Limit and Thermal Overload Protection ..... | 24 |
| Insulation Characteristics .....  | 10 | Power Considerations .....                          | 24 |
| Recommended Operating Conditions .....  | 10 | Thermal Analysis .....                              | 25 |
| Absolute Maximum Ratings .....  | 11 | Insulation Lifetime .....                           | 25 |
| ESD Caution .....   | 11 | Outline Dimensions .....                            | 26 |
|   |    | Ordering Guide .....                                | 27 |

## REVISION HISTORY

### 4/12—Rev. 0 to Rev. A

|  |    |   |    |
|--|----|---|----|
| Changes to Features Section, General Description Section,<br>and Table 1 ..... | 1  | Changes to Figure 19 and Figure 20 .....                                | 18 |
| Changes to Table 2 and Table 3 .....   | 3  | Added Figure 21 and Figure 22; Renumbered<br>Figures Sequentially ..... | 18 |
| Changes to Endnote 1 in Table 5 .....  | 4  | Added Definition of $I_{ISO(Load)}$ to Terminology Section .....        | 20 |
| Changes to Table 6 and Table 7 .....   | 5  | Changes to PCB Layout Section .....                                     | 21 |
| Change to Propagation Delay Parameter in Table 8 .....                         | 5  | Added Start-Up Behavior Section .....                                   | 21 |
| Changes to Endnote 1 in Table 9; Changes to Table 10 .....                     | 6  | Changes to EMI Considerations Section .....                             | 22 |
| Changes to Table 11 .....  | 7  | Moved Propagation Delay Parameters Section .....                        | 22 |
| Changes to Endnote 1 in Table 13; Changes to Table 14 .....                    | 8  | Changes to Power Consumption Section .....                              | 23 |
| Changes to Regulatory Information Section, Table 15,<br>and Table 16 .....     | 9  | Added Current Limit and Thermal Overload Protection<br>Section .....    | 24 |
| Changes to Insulation Characteristics Section, Table 17,<br>and Table 18 ..... | 10 | Moved Thermal Analysis Section .....                                    | 25 |
| Changes to Table 20 .....  | 11 | Changes to Insulation Lifetime Section and Figure 33 .....              | 25 |
| Changes to Table 26 .....  | 16 | Updated Outline Dimensions .....  | 26 |
| Changes to Figure 13, Figure 14, Figure 15, Figure 17,<br>and Figure 18 .....  | 17 | Changes to Ordering Guide .....   | 27 |

### 5/09—Revision 0: Initial Version

## SPECIFICATIONS

### ELECTRICAL CHARACTERISTICS—5 V PRIMARY INPUT SUPPLY/5 V SECONDARY ISOLATED SUPPLY

Typical specifications are at  $T_A = 25^\circ\text{C}$ ,  $V_{DD1} = V_{SEL} = V_{ISO} = 5\text{ V}$ . Minimum/maximum specifications apply over the entire recommended operation range, which is  $4.5\text{ V} \leq V_{DD1}, V_{SEL}, V_{ISO} \leq 5.5\text{ V}$ , and  $-40^\circ\text{C} \leq T_A \leq +105^\circ\text{C}$ , unless otherwise noted. Switching specifications are tested with  $C_L = 15\text{ pF}$  and CMOS signal levels, unless otherwise noted.

Table 2. DC-to-DC Converter Static Specifications

| Parameter                       | Symbol           | Min | Typ | Max | Unit   | Test Conditions/Comments  |
|---------------------------------|------------------|-----|-----|-----|--------|---|
| DC-TO-DC CONVERTER SUPPLY       |                  |     |     |     |        |   |
| Setpoint                        | $V_{ISO}$        | 4.7 | 5.0 | 5.4 | V      | $I_{ISO} = 0\text{ mA}$   |
| Line Regulation                 | $V_{ISO(LINE)}$  |     | 1   |     | mV/V   | $I_{ISO} = 40\text{ mA}$ , $V_{DD1} = 4.5\text{ V to }5.5\text{ V}$                                   |
| Load Regulation                 | $V_{ISO(LOAD)}$  |     | 1   | 5   | %      | $I_{ISO} = 8\text{ mA to }72\text{ mA}$   |
| Output Ripple                   | $V_{ISO(RIP)}$   |     | 75  |     | mV p-p | 20 MHz bandwidth, $C_{BO} = 0.1\text{ }\mu\text{F}  10\text{ }\mu\text{F}$ , $I_{ISO} = 72\text{ mA}$ |
| Output Noise                    | $V_{ISO(NOISE)}$ |     | 200 |     | mV p-p | $C_{BO} = 0.1\text{ }\mu\text{F}  10\text{ }\mu\text{F}$ , $I_{ISO} = 72\text{ mA}$                   |
| Switching Frequency             | $f_{OSC}$        |     | 180 |     | MHz    |   |
| PWM Frequency                   | $f_{PWM}$        |     | 625 |     | kHz    |   |
| Output Supply Current           | $I_{ISO(MAX)}$   | 80  |     |     | mA     | $V_{ISO} > 4.5\text{ V}$  |
| Efficiency at $I_{ISO(MAX)}$    |                  |     | 34  |     | %      | $I_{ISO} = 80\text{ mA}$  |
| $I_{DD1}$ , No $V_{ISO}$ Load   | $I_{DD1(Q)}$     |     | 13  | 35  | mA     |   |
| $I_{DD1}$ , Full $V_{ISO}$ Load | $I_{DD1(MAX)}$   |     | 290 |     | mA     |   |

Table 3. DC-to-DC Converter Dynamic Specifications

| Parameter         | Symbol          | 1 Mbps—A or C Grade |     |     | 25 Mbps—C Grade |     |     | Unit | Test Conditions/<br>Comments |
|-------------------|-----------------|---------------------|-----|-----|-----------------|-----|-----|------|------------------------------|
|                   |                 | Min                 | Typ | Max | Min             | Typ | Max |      |                              |
| SUPPLY CURRENT    |                 |                     |     |     |                 |     |     |      |                              |
| Input             | $I_{DD1(D)}$    |                     |     |     |                 |     |     |      |                              |
| ADuM6400          |                 |                     | 12  |     |                 | 64  |     | mA   | No $V_{ISO}$ load            |
| ADuM6401          |                 |                     | 12  |     |                 | 68  |     | mA   | No $V_{ISO}$ load            |
| ADuM6402          |                 |                     | 13  |     |                 | 71  |     | mA   | No $V_{ISO}$ load            |
| ADuM6403          |                 |                     | 14  |     |                 | 75  |     | mA   | No $V_{ISO}$ load            |
| ADuM6404          |                 |                     | 14  |     |                 | 78  |     | mA   | No $V_{ISO}$ load            |
| Available to Load | $I_{ISO(LOAD)}$ |                     |     |     |                 |     |     |      |                              |
| ADuM6400          |                 |                     | 80  |     |                 | 69  |     | mA   |                              |
| ADuM6401          |                 |                     | 80  |     |                 | 67  |     | mA   |                              |
| ADuM6402          |                 |                     | 80  |     |                 | 65  |     | mA   |                              |
| ADuM6403          |                 |                     | 80  |     |                 | 63  |     | mA   |                              |
| ADuM6404          |                 |                     | 80  |     |                 | 61  |     | mA   |                              |

Table 4. Switching Specifications

| Parameter                         | Symbol             | A Grade |     |     | C Grade |     |     | Unit  | Test Conditions/<br>Comments |
|-----------------------------------|--------------------|---------|-----|-----|---------|-----|-----|-------|------------------------------|
|                                   |                    | Min     | Typ | Max | Min     | Typ | Max |       |                              |
| SWITCHING SPECIFICATIONS          |                    |         |     |     |         |     |     |       |                              |
| Data Rate                         |                    |         |     | 1   |         |     | 25  | Mbps  | Within PWD limit             |
| Propagation Delay                 | $t_{PHL}, t_{PLH}$ |         | 55  | 100 |         | 45  | 60  | ns    | 50% input to 50% output      |
| Pulse Width Distortion            | PWD                |         |     | 40  |         |     | 6   | ns    | $ t_{PLH} - t_{PHL} $        |
| Change vs. Temperature            |                    |         |     |     |         | 5   |     | ps/°C |                              |
| Pulse Width                       | PW                 | 1000    |     |     | 40      |     |     | ns    | Within PWD limit             |
| Propagation Delay Skew            | $t_{PSK}$          |         |     | 50  |         |     | 15  | ns    | Between any two units        |
| Channel Matching                  |                    |         |     |     |         |     |     |       |                              |
| Codirectional <sup>1</sup>        | $t_{PSKCD}$        |         |     | 50  |         |     | 6   | ns    |                              |
| Opposing Directional <sup>2</sup> | $t_{PSKOD}$        |         |     | 50  |         |     | 15  | ns    |                              |

<sup>1</sup> Codirectional channel matching is the absolute value of the difference in propagation delays between any two channels with inputs on the same side of the isolation barrier.

<sup>2</sup> Opposing directional channel matching is the absolute value of the difference in propagation delays between any two channels with inputs on opposite sides of the isolation barrier.

Table 5. Input and Output Characteristics

| Parameter                                   | Symbol    | Min  | Typ   | Max | Unit        | Test Conditions/<br>Comments   |
|---|-----------|--|-------|-----|-------------|--|
| DC SPECIFICATIONS                           |           |  |       |     |             |  |
| Logic High Input Threshold                  | $V_{IH}$  | $0.7 \times V_{ISO}$ or $0.7 \times V_{DD1}$ |       |     | V           |  |
| Logic Low Input Threshold                   | $V_{IL}$  |  |       |     | V           |  |
| Logic High Output Voltages                  | $V_{OH}$  | $V_{DD1} - 0.3$ or $V_{ISO} - 0.3$           | 5.0   |     | V           | $I_{Ox} = -20 \mu A, V_{Ix} = V_{IxH}$   |
|   |           | $V_{DD1} - 0.5$ or $V_{ISO} - 0.5$           | 4.8   |     | V           | $I_{Ox} = -4 mA, V_{Ix} = V_{IxH}$   |
| Logic Low Output Voltages                   | $V_{OL}$  |  | 0.0   | 0.1 | V           | $I_{Ox} = 20 \mu A, V_{Ix} = V_{IxL}$  |
|   |           |  | 0.2   | 0.4 | V           | $I_{Ox} = 4 mA, V_{Ix} = V_{IxL}$  |
| Undervoltage Lockout                        | UVLO      |  |       |     |             | $V_{DD1}, V_{DDL}, V_{ISO}$ supplies   |
| Positive-Going Threshold                    | $V_{UV+}$ |  | 2.7   |     | V           |  |
| Negative-Going Threshold                    | $V_{UV-}$ |  | 2.4   |     | V           |  |
| Hysteresis                                  | $V_{UVH}$ |  | 0.3   |     | V           |  |
| Input Currents per Channel                  | $I_i$     | -20  | +0.01 | +20 | $\mu A$     | $0 V \leq V_{Ix} \leq V_{DDx}$   |
| AC SPECIFICATIONS                           |           |  |       |     |             |  |
| Output Rise/Fall Time                       | $t_R/t_F$ |  | 2.5   |     | ns          | 10% to 90%   |
| Common-Mode Transient Immunity <sup>1</sup> | $ CM $    | 25   | 35    |     | kV/ $\mu s$ | $V_{Ix} = V_{DD1}$ or $V_{ISO}, V_{CM} = 1000 V,$<br>transient magnitude = 800 V |
| Refresh Rate                                | $f_r$     |  | 1.0   |     | Mbps        |  |

<sup>1</sup>  $|CM|$  is the maximum common-mode voltage slew rate that can be sustained while maintaining  $V_o > 0.7 \times V_{DD1}$  or  $0.7 \times V_{ISO}$  for a high input or  $V_o < 0.3 \times V_{DD1}$  or  $0.3 \times V_{ISO}$  for a low input. The common-mode voltage slew rates apply to both rising and falling common-mode voltage edges.

**ELECTRICAL CHARACTERISTICS—3.3 V PRIMARY INPUT SUPPLY/3.3 V SECONDARY ISOLATED SUPPLY**

Typical specifications are at  $T_A = 25^\circ\text{C}$ ,  $V_{DD1} = V_{ISO} = 3.3\text{ V}$ ,  $V_{SEL} = \text{GND}_{ISO}$ . Minimum/maximum specifications apply over the entire recommended operation range, which is  $3.0\text{ V} \leq V_{DD1}$ ,  $V_{SEL}$ ,  $V_{ISO} \leq 3.6\text{ V}$ , and  $-40^\circ\text{C} \leq T_A \leq +105^\circ\text{C}$ , unless otherwise noted. Switching specifications are tested with  $C_L = 15\text{ pF}$  and CMOS signal levels, unless otherwise noted.

**Table 6. DC-to-DC Converter Static Specifications**

| Parameter                       | Symbol           | Min | Typ | Max | Unit   | Test Conditions/Comments  |
|---------------------------------|------------------|-----|-----|-----|--------|---|
| DC-TO-DC CONVERTER SUPPLY       |                  |     |     |     |        |   |
| Setpoint                        | $V_{ISO}$        | 3.0 | 3.3 | 3.6 | V      | $I_{ISO} = 0\text{ mA}$   |
| Line Regulation                 | $V_{ISO(LINE)}$  |     | 1   |     | mV/V   | $I_{ISO} = 20\text{ mA}$ , $V_{DD1} = 3.0\text{ V to } 3.6\text{ V}$                                  |
| Load Regulation                 | $V_{ISO(LOAD)}$  |     | 1   | 5   | %      | $I_{ISO} = 4\text{ mA to } 36\text{ mA}$  |
| Output Ripple                   | $V_{ISO(RIP)}$   |     | 50  |     | mV p-p | 20 MHz bandwidth, $C_{BO} = 0.1\text{ }\mu\text{F}  10\text{ }\mu\text{F}$ , $I_{ISO} = 54\text{ mA}$ |
| Output Noise                    | $V_{ISO(NOISE)}$ |     | 130 |     | mV p-p | $C_{BO} = 0.1\text{ }\mu\text{F}  10\text{ }\mu\text{F}$ , $I_{ISO} = 54\text{ mA}$                   |
| Switching Frequency             | $f_{OSC}$        |     | 180 |     | MHz    |   |
| PWM Frequency                   | $f_{PWM}$        |     | 625 |     | kHz    |   |
| Output Supply Current           | $I_{ISO(MAX)}$   | 40  |     |     | mA     | $V_{ISO} > 3\text{ V}$  |
| Efficiency at $I_{ISO(MAX)}$    |                  |     | 33  |     | %      | $I_{ISO} = 40\text{ mA}$  |
| $I_{DD1}$ , No $V_{ISO}$ Load   | $I_{DD1(Q)}$     |     | 15  | 28  | mA     |   |
| $I_{DD1}$ , Full $V_{ISO}$ Load | $I_{DD1(MAX)}$   |     | 175 |     | mA     |   |

**Table 7. DC-to-DC Converter Dynamic Specifications**

| Parameter         | Symbol          | 1 Mbps—A or C Grade |     |     | 25 Mbps—C Grade |     |     | Unit              | Test Conditions/<br>Comments |
|-------------------|-----------------|---------------------|-----|-----|-----------------|-----|-----|-------------------|------------------------------|
|                   |                 | Min                 | Typ | Max | Min             | Typ | Max |                   |                              |
| SUPPLY CURRENT    |                 |                     |     |     |                 |     |     |                   |                              |
| Input             | $I_{DD1(D)}$    |                     |     |     |                 |     |     |                   |                              |
| ADuM6400          |                 |                     | 8   |     |                 | 41  |     | mA                | No $V_{ISO}$ load            |
| ADuM6401          |                 |                     | 8   |     |                 | 44  |     | mA                | No $V_{ISO}$ load            |
| ADuM6402          |                 |                     | 8   |     |                 | 46  |     | mA                | No $V_{ISO}$ load            |
| ADuM6403          |                 |                     | 9   |     |                 | 47  |     | mA                | No $V_{ISO}$ load            |
| ADuM6404          |                 | 9                   |     |     | 51              |     | mA  | No $V_{ISO}$ load |                              |
| Available to Load | $I_{ISO(LOAD)}$ |                     |     |     |                 |     |     |                   |                              |
| ADuM6400          |                 |                     | 40  |     |                 | 33  |     | mA                |                              |
| ADuM6401          |                 |                     | 40  |     |                 | 31  |     | mA                |                              |
| ADuM6402          |                 |                     | 40  |     |                 | 30  |     | mA                |                              |
| ADuM6403          |                 |                     | 40  |     |                 | 29  |     | mA                |                              |
| ADuM6404          |                 | 40                  |     |     | 28              |     | mA  |                   |                              |

**Table 8. Switching Specifications**

| Parameter                         | Symbol                | A Grade |     |     | C Grade |     |     | Unit  | Test Conditions/<br>Comments |
|-----------------------------------|-----------------------|---------|-----|-----|---------|-----|-----|-------|------------------------------|
|                                   |                       | Min     | Typ | Max | Min     | Typ | Max |       |                              |
| SWITCHING SPECIFICATIONS          |                       |         |     |     |         |     |     |       |                              |
| Data Rate                         |                       |         |     | 1   |         |     | 25  | Mbps  | Within PWD limit             |
| Propagation Delay                 | $t_{PHL}$ , $t_{PLH}$ |         | 60  | 100 |         | 45  | 65  | ns    | 50% input to 50% output      |
| Pulse Width Distortion            | PWD                   |         |     | 40  |         |     | 6   | ns    | $ t_{PLH} - t_{PHL} $        |
| Change vs. Temperature            |                       |         |     |     |         | 5   |     | ps/°C |                              |
| Pulse Width                       | PW                    | 1000    |     |     | 40      |     |     | ns    | Within PWD limit             |
| Propagation Delay Skew            | $t_{PSK}$             |         |     | 50  |         |     | 45  | ns    | Between any two units        |
| Channel Matching                  |                       |         |     |     |         |     |     |       |                              |
| Codirectional <sup>1</sup>        | $t_{PSKCD}$           |         |     | 50  |         |     | 6   | ns    |                              |
| Opposing Directional <sup>2</sup> | $t_{PSKOD}$           |         |     | 50  |         |     | 15  | ns    |                              |

<sup>1</sup> Codirectional channel matching is the absolute value of the difference in propagation delays between any two channels with inputs on the same side of the isolation barrier.

<sup>2</sup> Opposing directional channel matching is the absolute value of the difference in propagation delays between any two channels with inputs on opposite sides of the isolation barrier.

Table 9. Input and Output Characteristics

| Parameter                                   | Symbol    | Min  | Typ   | Max | Unit        | Test Conditions/<br>Comments   |
|---|-----------|--|-------|-----|-------------|--|
| DC SPECIFICATIONS                           |           |  |       |     |             |  |
| Logic High Input Threshold                  | $V_{IH}$  | $0.7 \times V_{ISO}$ or $0.7 \times V_{DD1}$ |       |     | V           |  |
| Logic Low Input Threshold                   | $V_{IL}$  | $0.3 \times V_{ISO}$ or $0.3 \times V_{DD1}$ |       |     | V           |  |
| Logic High Output Voltages                  | $V_{OH}$  | $V_{DD1} - 0.2$ or $V_{ISO} - 0.2$           | 3.3   |     | V           | $I_{OX} = -20 \mu A, V_{IX} = V_{IXH}$   |
|   |           | $V_{DD1} - 0.5$ or $V_{ISO} - 0.5$           | 3.1   |     | V           | $I_{OX} = -4 \text{ mA}, V_{IX} = V_{IXH}$   |
| Logic Low Output Voltages                   | $V_{OL}$  |  | 0.0   | 0.1 | V           | $I_{OX} = 20 \mu A, V_{IX} = V_{IXL}$  |
|   |           |  | 0.0   | 0.4 | V           | $I_{OX} = 4 \text{ mA}, V_{IX} = V_{IXL}$  |
| Undervoltage Lockout                        | UVLO      |  |       |     |             | $V_{DD1}, V_{DDL}, V_{ISO}$ supplies   |
| Positive-Going Threshold                    | $V_{UV+}$ |  | 2.7   |     | V           |  |
| Negative-Going Threshold                    | $V_{UV-}$ |  | 2.4   |     | V           |  |
| Hysteresis                                  | $V_{UVH}$ |  | 0.3   |     | V           |  |
| Input Currents per Channel                  | $I_i$     | -10  | +0.01 | +10 | $\mu A$     | $0 \text{ V} \leq V_{IX} \leq V_{DDX}$   |
| AC SPECIFICATIONS                           |           |  |       |     |             |  |
| Output Rise/Fall Time                       | $t_r/t_f$ |  | 2.5   |     | ns          | 10% to 90%   |
| Common-Mode Transient Immunity <sup>1</sup> | CM        | 25   | 35    |     | kV/ $\mu s$ | $V_{IX} = V_{DD1}$ or $V_{ISO}, V_{CM} = 1000 \text{ V}$ , transient magnitude = 800 V |
| Refresh Rate                                | $f_r$     |  | 1.0   |     | Mbps        |  |

<sup>1</sup> |CM| is the maximum common-mode voltage slew rate that can be sustained while maintaining  $V_O > 0.7 \times V_{DD1}$  or  $0.7 \times V_{ISO}$  for a high input or  $V_O < 0.3 \times V_{DD1}$  or  $0.3 \times V_{ISO}$  for a low input. The common-mode voltage slew rates apply to both rising and falling common-mode voltage edges.

## ELECTRICAL CHARACTERISTICS—5 V PRIMARY INPUT SUPPLY/3.3 V SECONDARY ISOLATED SUPPLY

Typical specifications are at  $T_A = 25^\circ\text{C}$ ,  $V_{DD1} = 5.0 \text{ V}$ ,  $V_{ISO} = 3.3 \text{ V}$ ,  $V_{SEL} = \text{GND}_{ISO}$ . Minimum/maximum specifications apply over the entire recommended operation range, which is  $4.5 \text{ V} \leq V_{DD1} \leq 5.5 \text{ V}$ ,  $3.0 \text{ V} \leq V_{ISO} \leq 3.6 \text{ V}$ , and  $-40^\circ\text{C} \leq T_A \leq +105^\circ\text{C}$ , unless otherwise noted.

Switching specifications are tested with  $C_L = 15 \text{ pF}$  and CMOS signal levels, unless otherwise noted.

Table 10. DC-to-DC Converter Static Specifications

| Parameter                       | Symbol           | Min | Typ | Max | Unit   | Test Conditions/Comments  |
|---------------------------------|------------------|-----|-----|-----|--------|---|
| DC-TO-DC CONVERTER SUPPLY       |                  |     |     |     |        |   |
| Setpoint                        | $V_{ISO}$        | 3.0 | 3.3 | 3.6 | V      | $I_{ISO} = 0 \text{ mA}$  |
| Line Regulation                 | $V_{ISO(LINE)}$  |     | 1   |     | mV/V   | $I_{ISO} = 50 \text{ mA}, V_{DD1} = 4.5 \text{ V to } 5.5 \text{ V}$                    |
| Load Regulation                 | $V_{ISO(LOAD)}$  |     | 1   | 5   | %      | $I_{ISO} = 10 \text{ mA to } 90 \text{ mA}$   |
| Output Ripple                   | $V_{ISO(RIP)}$   |     | 50  |     | mV p-p | 20 MHz bandwidth, $C_{BO} = 0.1 \mu\text{F}    10 \mu\text{F}, I_{ISO} = 90 \text{ mA}$ |
| Output Noise                    | $V_{ISO(NOISE)}$ |     | 130 |     | mV p-p | $C_{BO} = 0.1 \mu\text{F}    10 \mu\text{F}, I_{ISO} = 90 \text{ mA}$                   |
| Switching Frequency             | $f_{OSC}$        |     | 180 |     | MHz    |   |
| PWM Frequency                   | $f_{PWM}$        |     | 625 |     | kHz    |   |
| Output Supply Current           | $I_{ISO(MAX)}$   | 100 |     |     | mA     | $V_{ISO} > 3 \text{ V}$   |
| Efficiency at $I_{ISO(MAX)}$    |                  |     | 30  |     | %      | $I_{ISO} = 100 \text{ mA}$  |
| $I_{DD1}$ , No $V_{ISO}$ Load   | $I_{DD1(Q)}$     |     | 11  | 20  | mA     |   |
| $I_{DD1}$ , Full $V_{ISO}$ Load | $I_{DD1(MAX)}$   |     | 230 |     | mA     |   |

Table 11. DC-to-DC Converter Dynamic Specifications

| Parameter         | Symbol                 | 1 Mbps—A or C Grade |     |     | 25 Mbps—C Grade |     |     | Unit                     | Test Conditions/<br>Comments |
|-------------------|------------------------|---------------------|-----|-----|-----------------|-----|-----|--------------------------|------------------------------|
|                   |                        | Min                 | Typ | Max | Min             | Typ | Max |                          |                              |
| SUPPLY CURRENT    |                        |                     |     |     |                 |     |     |                          |                              |
| Input             | I <sub>DD1(D)</sub>    |                     |     |     |                 |     |     |                          |                              |
| ADuM6400          |                        | 6                   |     |     | 43              |     |     | mA                       | No V <sub>ISO</sub> load     |
| ADuM6401          |                        | 6                   |     |     | 44              |     |     | mA                       | No V <sub>ISO</sub> load     |
| ADuM6402          |                        | 7                   |     |     | 45              |     |     | mA                       | No V <sub>ISO</sub> load     |
| ADuM6403          |                        | 7                   |     |     | 46              |     |     | mA                       | No V <sub>ISO</sub> load     |
| ADuM6404          | 7                      |                     |     | 47  |                 |     | mA  | No V <sub>ISO</sub> load |                              |
| Available to Load | I <sub>ISO(Load)</sub> |                     |     |     |                 |     |     |                          |                              |
| ADuM6400          |                        | 100                 |     |     | 93              |     |     | mA                       |                              |
| ADuM6401          |                        | 100                 |     |     | 92              |     |     | mA                       |                              |
| ADuM6402          |                        | 100                 |     |     | 91              |     |     | mA                       |                              |
| ADuM6403          |                        | 100                 |     |     | 89              |     |     | mA                       |                              |
| ADuM6404          | 100                    |                     |     | 88  |                 |     | mA  |                          |                              |

Table 12. Switching Specifications

| Parameter                         | Symbol                              | A Grade |     |     | C Grade |     |     | Unit  | Test Conditions/<br>Comments        |
|-----------------------------------|-------------------------------------|---------|-----|-----|---------|-----|-----|-------|-------------------------------------|
|                                   |                                     | Min     | Typ | Max | Min     | Typ | Max |       |                                     |
| SWITCHING SPECIFICATIONS          |                                     |         |     |     |         |     |     |       |                                     |
| Data Rate                         |                                     |         |     | 1   |         |     | 25  | Mbps  | Within PWD limit                    |
| Propagation Delay                 | t <sub>PHL</sub> , t <sub>PLH</sub> |         | 60  | 100 |         | 45  | 60  | ns    | 50% input to 50% output             |
| Pulse Width Distortion            | PWD                                 |         |     | 40  |         |     | 6   | ns    | t <sub>PLH</sub> – t <sub>PHL</sub> |
| Change vs. Temperature            |                                     |         |     |     |         | 5   |     | ps/°C |                                     |
| Pulse Width                       | PW                                  | 1000    |     |     | 40      |     |     | ns    | Within PWD limit                    |
| Propagation Delay Skew            | t <sub>PSK</sub>                    |         |     | 50  |         |     | 15  | ns    | Between any two units               |
| Channel Matching                  |                                     |         |     |     |         |     |     |       |                                     |
| Codirectional <sup>1</sup>        | t <sub>PSKCD</sub>                  |         |     | 50  |         |     | 6   | ns    |                                     |
| Opposing Directional <sup>2</sup> | t <sub>PSKOD</sub>                  |         |     | 50  |         |     | 15  | ns    |                                     |

<sup>1</sup> Codirectional channel matching is the absolute value of the difference in propagation delays between any two channels with inputs on the same side of the isolation barrier.

<sup>2</sup> Opposing directional channel matching is the absolute value of the difference in propagation delays between any two channels with inputs on opposite sides of the isolation barrier.

Table 13. Input and Output Characteristics

| Parameter                                   | Symbol    | Min   | Typ                                   | Max   | Unit        | Test Conditions/Comments  |
|---|-----------|---|---------------------------------------|---|-------------|---|
| DC SPECIFICATIONS                           |           |   |                                       |   |             |   |
| Logic High Input Threshold                  | $V_{IH}$  | $0.7 \times V_{ISO}$ or<br>$0.7 \times V_{DD1}$ |                                       |   | V           |   |
| Logic Low Input Threshold                   | $V_{IL}$  |   |                                       | $0.3 \times V_{ISO}$ or<br>$0.3 \times V_{DD1}$ | V           |   |
| Logic High Output Voltages                  | $V_{OH}$  | $V_{DD1} - 0.2$ or<br>$V_{ISO} - 0.2$           | $V_{DD1}$ or $V_{ISO}$                |   | V           | $I_{OX} = -20 \mu A, V_{IX} = V_{IXH}$  |
|   |           | $V_{DD1} - 0.5$ or<br>$V_{ISO} - 0.5$           | $V_{DD1} - 0.2$ or<br>$V_{ISO} - 0.2$ |   | V           | $I_{OX} = -4 \text{ mA}, V_{IX} = V_{IXH}$  |
| Logic Low Output Voltages                   | $V_{OL}$  |   | 0.0                                   | 0.1   | V           | $I_{OX} = 20 \mu A, V_{IX} = V_{IXL}$   |
|   |           |   | 0.0                                   | 0.4   | V           | $I_{OX} = 4 \text{ mA}, V_{IX} = V_{IXL}$   |
| Undervoltage Lockout                        | UVLO      |   |                                       |   |             | $V_{DD1}, V_{DDL}, V_{ISO}$ supplies  |
| Positive-Going Threshold                    | $V_{UV+}$ |   | 2.7                                   |   | V           |   |
| Negative-Going Threshold                    | $V_{UV-}$ |   | 2.4                                   |   | V           |   |
| Hysteresis                                  | $V_{UVH}$ |   | 0.3                                   |   | V           |   |
| Input Currents per Channel                  | $I_I$     | -10   | +0.01                                 | +10   | $\mu A$     | $0 \text{ V} \leq V_{IX} \leq V_{DDX}$  |
| AC SPECIFICATIONS                           |           |   |                                       |   |             |   |
| Output Rise/Fall Time                       | $t_R/t_F$ |   | 2.5                                   |   | ns          | 10% to 90%  |
| Common-Mode Transient Immunity <sup>1</sup> | CM        | 25  | 35                                    |   | kV/ $\mu s$ | $V_{IX} = V_{DD1}$ or $V_{ISO}, V_{CM} = 1000 \text{ V}$ ,<br>transient magnitude = 800 V |
| Refresh Rate                                | $f_r$     |   | 1.0                                   |   | Mbps        |   |

<sup>1</sup> |CM| is the maximum common-mode voltage slew rate that can be sustained while maintaining  $V_O > 0.7 \times V_{DD1}$  or  $0.7 \times V_{ISO}$  for a high input or  $V_O < 0.3 \times V_{DD1}$  or  $0.3 \times V_{ISO}$  for a low input. The common-mode voltage slew rates apply to both rising and falling common-mode voltage edges.

## PACKAGE CHARACTERISTICS

Table 14.

| Parameter                                  | Symbol        | Min | Typ       | Max | Unit          | Test Conditions/Comments  |
|--|---------------|-----|-----------|-----|---------------|---|
| RESISTANCE AND CAPACITANCE                 |               |     |           |     |               |   |
| Resistance (Input-to-Output) <sup>1</sup>  | $R_{I-O}$     |     | $10^{12}$ |     | $\Omega$      |   |
| Capacitance (Input-to-Output) <sup>1</sup> | $C_{I-O}$     |     | 2.2       |     | pF            | $f = 1 \text{ MHz}$   |
| Input Capacitance <sup>2</sup>             | $C_I$         |     | 4.0       |     | pF            |   |
| IC Junction-to-Ambient Thermal Resistance  | $\theta_{JA}$ |     | 45        |     | $^{\circ}C/W$ | Thermocouple is located at the center of the package underside; test conducted on a 4-layer board with thin traces <sup>3</sup> |
| THERMAL SHUTDOWN                           |               |     |           |     |               |   |
| Thermal Shutdown Threshold                 | $TS_{SD}$     |     | 150       |     | $^{\circ}C$   | $T_J$ rising  |
| Thermal Shutdown Hysteresis                | $TS_{SD-HYS}$ |     | 20        |     | $^{\circ}C$   |   |

<sup>1</sup> This device is considered a 2-terminal device; Pin 1 through Pin 8 are shorted together, and Pin 9 through Pin 16 are shorted together.

<sup>2</sup> Input capacitance is from any input data pin to ground.

<sup>3</sup> Refer to the Thermal Analysis section for thermal model definitions.



**REGULATORY INFORMATION**

The [ADuM6400/ADuM6401/ADuM6402/ADuM6403/ADuM6404](#) are approved by the organizations listed in Table 15. Refer to Table 20 and the Insulation Lifetime section for more information about the recommended maximum working voltages for specific cross-insulation waveforms and insulation levels.

**Table 15.**

| UL <sup>1</sup>  | CSA (Pending)   | VDE  |
|--|---|--|
| Recognized under UL 1577 component recognition program | Approved under CSA Component Acceptance Notice #5A  | RW-16 package: <sup>2</sup><br>Certified according to IEC 60747-5-2 (VDE 0884 Part 2):2003-01 (pending)<br>Basic insulation, 846 V peak  |
| Single protection, 5000 V rms isolation voltage        | Basic insulation per CSA 60950-1-07 and IEC 60950-1, 600 V rms (848 V peak) maximum working voltage<br><br>RW-16 package:<br>Reinforced insulation per CSA 60950-1-07 and IEC 60950-1, 380 V rms (537 V peak) maximum working voltage<br>Reinforced insulation per IEC 60601-1, 125 V rms (176 V peak) maximum working voltage<br>RI-16-1 package:<br>Reinforced insulation per CSA 60950-1-07 and IEC 60950-1, 400 V rms (565 V peak) maximum working voltage<br>Reinforced insulation per IEC 60601-1, 250 V rms (353 V peak) maximum working voltage | RI-16-1 package: <sup>3</sup><br>Certified according to DIN V VDE V 0884-10 (VDE V 0884-10):2006-12<br>Reinforced insulation, 846 V peak |
| File E214100   | File 205078   | File 2471900-4880-0001   |

<sup>1</sup> In accordance with UL 1577, each [ADuM6400/ADuM6401/ADuM6402/ADuM6403/ADuM6404](#) is proof-tested by applying an insulation test voltage  $\geq 6000$  V rms for 1 sec (current leakage detection limit = 20  $\mu$ A).

<sup>2</sup> In accordance with IEC 60747-5-2 (VDE 0884 Part 2):2003-01, each [ADuM6400/ADuM6401/ADuM6402/ADuM6403/ADuM6404](#) in the RW-16 package is proof-tested by applying an insulation test voltage  $\geq 1590$  V peak for 1 sec (partial discharge detection limit = 5 pC). The asterisk (\*) marking branded on the component designates IEC 60747-5-2 (VDE 0884 Part 2):2003-01 approval.

<sup>3</sup> In accordance with DIN V VDE V 0884-10 (VDE V 0884-10):2006-12, each [ADuM6400/ADuM6401/ADuM6402/ADuM6403/ADuM6404](#) in the RI-16-1 package is proof-tested by applying an insulation test voltage  $\geq 1590$  V peak for 1 sec (partial discharge detection limit = 5 pC). The asterisk (\*) marking branded on the component designates DIN V VDE V 0884-10 (VDE V 0884-10):2006-12 approval.

**INSULATION AND SAFETY-RELATED SPECIFICATIONS****Table 16.**

| Parameter  | Symbol | Value     | Unit  | Test Conditions/Comments   |
|--|--------|-----------|-------|--|
| Rated Dielectric Insulation Voltage              |        | 5000      | V rms | 1-minute duration  |
| Minimum External Air Gap (Clearance)             | L(I01) | 8.0       | mm    | Measured from input terminals to output terminals, shortest distance through air     |
| Minimum External Tracking (Creepage)             | L(I02) |           |       | Measured from input terminals to output terminals, shortest distance path along body |
| RW-16 Package                                    |        | 7.6       | mm    |  |
| RI-16-1 Package                                  |        | 8.3       | mm    |  |
| Minimum Internal Distance (Internal Clearance)   |        | 0.017 min | mm    | Distance through insulation  |
| Tracking Resistance (Comparative Tracking Index) | CTI    | >175      | V     | DIN IEC 112/VDE 0303, Part 1   |
| Material Group                                   |        | IIIa      |       | Material Group (DIN VDE 0110, 1/89, Table 1)   |

**INSULATION CHARACTERISTICS**

**IEC 60747-5-2 (VDE 0884 Part 2):2003-01 and DIN V VDE V 0884-10 (VDE V 0884-10):2006-12**

These isolators are suitable for reinforced electrical isolation only within the safety limit data. Maintenance of the safety data is ensured by protective circuits. The asterisk (\*) marking branded on the components designates IEC 60747-5-2 (VDE 0884 Part 2):2003-01 or DIN V VDE V 0884-10 (VDE V 0884-10):2006-12 approval.

**Table 17.**

| Description   | Test Conditions/Comments   | Symbol     | Characteristic                | Unit   |
|---|--|------------|-------------------------------|--------|
| Installation Classification per DIN VDE 0110<br>For Rated Mains Voltage ≤ 300 V rms<br>For Rated Mains Voltage ≤ 450 V rms<br>For Rated Mains Voltage ≤ 600 V rms |  |            | I to IV<br>I to II<br>I to II |        |
| Climatic Classification   |  |            | 40/105/21                     |        |
| Pollution Degree per DIN VDE 0110, Table 1  |  |            | 2                             |        |
| Maximum Working Insulation Voltage  |  | $V_{IORM}$ | 846                           | V peak |
| Input-to-Output Test Voltage<br>Method b1   | $V_{IORM} \times 1.875 = V_{PR}$ , 100% production test, $t_m = 1$ sec, partial discharge < 5 pC | $V_{PR}$   | 1590                          | V peak |
| Method a  |  | $V_{PR}$   |                               |        |
| After Environmental Tests Subgroup 1  | $V_{IORM} \times 1.6 = V_{PR}$ , $t_m = 60$ sec, partial discharge < 5 pC                        |            | 1375                          | V peak |
| After Input and/or Safety Tests Subgroup 2 and Subgroup 3   | $V_{IORM} \times 1.2 = V_{PR}$ , $t_m = 60$ sec, partial discharge < 5 pC                        |            | 1018                          | V peak |
| Highest Allowable Overvoltage   | Transient overvoltage, $t_{TR} = 10$ sec   | $V_{IOTM}$ | 6000                          | V peak |
| Safety-Limiting Values  | Maximum value allowed in the event of a failure (see Figure 7)                                   |            |                               |        |
| Case Temperature  |  | $T_S$      | 150                           | °C     |
| Side 1 Current ( $I_{DD1}$ )  |  | $I_{S1}$   | 555                           | mA     |
| Insulation Resistance at $T_S$  | $V_{IO} = 500$ V   | $R_S$      | >10 <sup>9</sup>              | Ω      |

**Thermal Derating Curve**

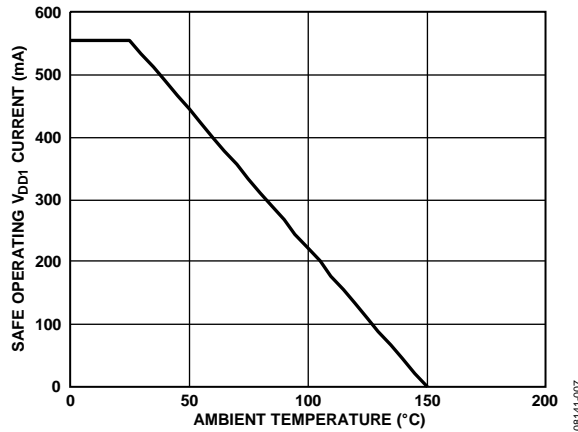

Figure 7. Thermal Derating Curve, Dependence of Safety-Limiting Values on Case Temperature, per DIN EN 60747-5-2

**RECOMMENDED OPERATING CONDITIONS**

**Table 18.**

| Parameter                         | Symbol    | Min | Max  | Unit | Test Conditions/Comments   |
|-----------------------------------|-----------|-----|------|------|--|
| TEMPERATURE                       |           |     |      |      |  |
| Operating Temperature             | $T_A$     | -40 | +105 | °C   | Operation at 105°C requires reduction of the maximum load current as specified in Table 19 |
| SUPPLY VOLTAGES                   |           |     |      |      |  |
| $V_{DD1}$ @ $V_{SEL} = GND_{ISO}$ | $V_{DD1}$ | 3.0 | 5.5  | V    | Each voltage is relative to its respective ground  |
| $V_{DD1}$ @ $V_{SEL} = V_{ISO}$   |           | 4.5 | 5.5  | V    |  |

## ABSOLUTE MAXIMUM RATINGS

$T_A = 25^\circ\text{C}$ , unless otherwise noted.

**Table 19.**

| Parameter  | Rating   |
|--|--|
| Storage Temperature Range ( $T_{ST}$ )   | $-55^\circ\text{C}$ to $+150^\circ\text{C}$                  |
| Ambient Operating Temperature Range ( $T_A$ )  | $-40^\circ\text{C}$ to $+105^\circ\text{C}$                  |
| Supply Voltages ( $V_{DD1}$ , $V_{DDL}$ , $V_{ISO}$ ) <sup>1</sup>                     | $-0.5\text{ V}$ to $+7.0\text{ V}$                           |
| Input Voltage ( $V_{IA}$ , $V_{IB}$ , $V_{IC}$ , $V_{ID}$ , $V_{SEL}$ ) <sup>1,2</sup> | $-0.5\text{ V}$ to $V_{DD1} + 0.5\text{ V}$                  |
| Output Voltage ( $V_{OA}$ , $V_{OB}$ , $V_{OC}$ , $V_{OD}$ ) <sup>1,2</sup>            | $-0.5\text{ V}$ to $V_{DD0} + 0.5\text{ V}$                  |
| Average Output Current per Pin <sup>3</sup>  | $-10\text{ mA}$ to $+10\text{ mA}$                           |
| Common-Mode Transients <sup>4</sup>  | $-100\text{ kV}/\mu\text{s}$ to $+100\text{ kV}/\mu\text{s}$ |

<sup>1</sup> Each voltage is relative to its respective ground.

<sup>2</sup>  $V_{DD1}$  and  $V_{DD0}$  refer to the supply voltages on the input and output sides of a given channel, respectively. See the PCB Layout section.

<sup>3</sup> See Figure 7 for maximum rated current values for various temperatures.

<sup>4</sup> Common-mode transients exceeding the absolute maximum ratings may cause latch-up or permanent damage.

Stresses above those listed under Absolute Maximum Ratings may cause permanent damage to the device. This is a stress rating only; functional operation of the device at these or any other conditions above those indicated in the operational section of this specification is not implied. Exposure to absolute maximum rating conditions for extended periods may affect device reliability.

### ESD CAUTION



#### ESD (electrostatic discharge) sensitive device.

Charged devices and circuit boards can discharge without detection. Although this product features patented or proprietary protection circuitry, damage may occur on devices subjected to high energy ESD. Therefore, proper ESD precautions should be taken to avoid performance degradation or loss of functionality.

**Table 20. Maximum Continuous Working Voltage<sup>1</sup>**

| Parameter                     | Max | Unit   | Applicable Certification              |
|-------------------------------|-----|--------|---------------------------------------|
| AC Voltage, Bipolar Waveform  | 424 | V peak | All certifications, 50-year operation |
| AC Voltage, Unipolar Waveform |     |        |                                       |
| Basic Insulation              | 600 | V peak |                                       |
| Reinforced Insulation         | 565 | V peak | Working voltage per IEC 60950-1       |
| DC Voltage                    |     |        |                                       |
| Basic Insulation              | 600 | V peak |                                       |
| Reinforced Insulation         | 565 | V peak | Working voltage per IEC 60950-1       |

<sup>1</sup> Refers to the continuous voltage magnitude imposed across the isolation barrier. See the Insulation Lifetime section for more information.

## PIN CONFIGURATIONS AND FUNCTION DESCRIPTIONS

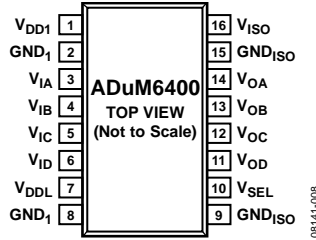

Figure 8. ADuM6400 Pin Configuration

Table 21. ADuM6400 Pin Function Descriptions

| Pin No. | Mnemonic           | Description   |
|---------|--------------------|---|
| 1       | V <sub>DD1</sub>   | Primary Supply Voltage, 3.0 V to 5.5 V. Pin 1 and Pin 7 must be connected to the same external voltage source.  |
| 2, 8    | GND <sub>1</sub>   | Ground Reference for the Primary Side of the Isolator. Pin 2 and Pin 8 are internally connected to each other, and it is recommended that both pins be connected to a common ground.              |
| 3       | V <sub>IA</sub>    | Logic Input A.  |
| 4       | V <sub>IB</sub>    | Logic Input B.  |
| 5       | V <sub>IC</sub>    | Logic Input C.  |
| 6       | V <sub>ID</sub>    | Logic Input D.  |
| 7       | V <sub>DDL</sub>   | Data Channel Supply Voltage, 3.0 V to 5.5 V. Pin 1 and Pin 7 must be connected to the same external voltage source.   |
| 9, 15   | GND <sub>ISO</sub> | Ground Reference for the Secondary Side of the Isolator. Pin 9 and Pin 15 are internally connected to each other, and it is recommended that both pins be connected to a common ground.           |
| 10      | V <sub>SEL</sub>   | Output Voltage Selection. When V <sub>SEL</sub> = V <sub>ISO</sub> , the V <sub>ISO</sub> setpoint is 5.0 V. When V <sub>SEL</sub> = GND <sub>ISO</sub> , the V <sub>ISO</sub> setpoint is 3.3 V. |
| 11      | V <sub>OD</sub>    | Logic Output D.   |
| 12      | V <sub>OC</sub>    | Logic Output C.   |
| 13      | V <sub>OB</sub>    | Logic Output B.   |
| 14      | V <sub>OA</sub>    | Logic Output A.   |
| 16      | V <sub>ISO</sub>   | Secondary Supply Voltage Output for External Loads: 3.3 V (V <sub>SEL</sub> = GND <sub>ISO</sub> ) or 5.0 V (V <sub>SEL</sub> = V <sub>ISO</sub> ).   |

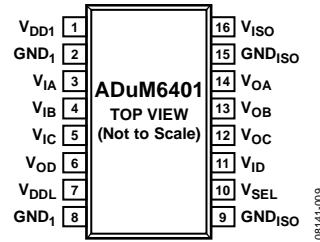

Figure 9. ADuM6401 Pin Configuration

Table 22. ADuM6401 Pin Function Descriptions

| Pin No. | Mnemonic           | Description   |
|---------|--------------------|---|
| 1       | V <sub>DD1</sub>   | Primary Supply Voltage, 3.0 V to 5.5 V. Pin 1 and Pin 7 must be connected to the same external voltage source.  |
| 2, 8    | GND <sub>1</sub>   | Ground Reference for the Primary Side of the Isolator. Pin 2 and Pin 8 are internally connected to each other, and it is recommended that both pins be connected to a common ground.              |
| 3       | V <sub>IA</sub>    | Logic Input A.  |
| 4       | V <sub>IB</sub>    | Logic Input B.  |
| 5       | V <sub>IC</sub>    | Logic Input C.  |
| 6       | V <sub>OD</sub>    | Logic Output D.   |
| 7       | V <sub>DDL</sub>   | Data Channel Supply Voltage, 3.0 V to 5.5 V. Pin 1 and Pin 7 must be connected to the same external voltage source.   |
| 9, 15   | GND <sub>ISO</sub> | Ground Reference for the Secondary Side of the Isolator. Pin 9 and Pin 15 are internally connected to each other, and it is recommended that both pins be connected to a common ground.           |
| 10      | V <sub>SEL</sub>   | Output Voltage Selection. When V <sub>SEL</sub> = V <sub>ISO</sub> , the V <sub>ISO</sub> setpoint is 5.0 V. When V <sub>SEL</sub> = GND <sub>ISO</sub> , the V <sub>ISO</sub> setpoint is 3.3 V. |
| 11      | V <sub>ID</sub>    | Logic Input D.  |
| 12      | V <sub>OC</sub>    | Logic Output C.   |
| 13      | V <sub>OB</sub>    | Logic Output B.   |
| 14      | V <sub>OA</sub>    | Logic Output A.   |
| 16      | V <sub>ISO</sub>   | Secondary Supply Voltage Output for External Loads: 3.3 V (V <sub>SEL</sub> = GND <sub>ISO</sub> ) or 5.0 V (V <sub>SEL</sub> = V <sub>ISO</sub> ).   |

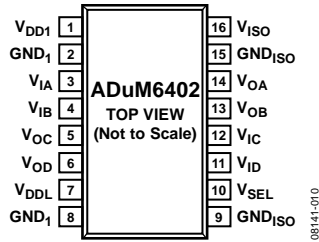

Figure 10. ADuM6402 Pin Configuration

Table 23. ADuM6402 Pin Function Descriptions

| Pin No. | Mnemonic           | Description   |
|---------|--------------------|---|
| 1       | V <sub>DD1</sub>   | Primary Supply Voltage, 3.0 V to 5.5 V. Pin 1 and Pin 7 must be connected to the same external voltage source.  |
| 2, 8    | GND <sub>1</sub>   | Ground Reference for the Primary Side of the Isolator. Pin 2 and Pin 8 are internally connected to each other, and it is recommended that both pins be connected to a common ground.              |
| 3       | V <sub>IA</sub>    | Logic Input A.  |
| 4       | V <sub>IB</sub>    | Logic Input B.  |
| 5       | V <sub>OC</sub>    | Logic Output C.   |
| 6       | V <sub>OD</sub>    | Logic Output D.   |
| 7       | V <sub>DDL</sub>   | Data Channel Supply Voltage, 3.0 V to 5.5 V. Pin 1 and Pin 7 must be connected to the same external voltage source.   |
| 9, 15   | GND <sub>ISO</sub> | Ground Reference for the Secondary Side of the Isolator. Pin 9 and Pin 15 are internally connected to each other, and it is recommended that both pins be connected to a common ground.           |
| 10      | V <sub>SEL</sub>   | Output Voltage Selection. When V <sub>SEL</sub> = V <sub>ISO</sub> , the V <sub>ISO</sub> setpoint is 5.0 V. When V <sub>SEL</sub> = GND <sub>ISO</sub> , the V <sub>ISO</sub> setpoint is 3.3 V. |
| 11      | V <sub>ID</sub>    | Logic Input D.  |
| 12      | V <sub>IC</sub>    | Logic Input C.  |
| 13      | V <sub>OB</sub>    | Logic Output B.   |
| 14      | V <sub>OA</sub>    | Logic Output A.   |
| 16      | V <sub>ISO</sub>   | Secondary Supply Voltage Output for External Loads: 3.3 V (V <sub>SEL</sub> = GND <sub>ISO</sub> ) or 5.0 V (V <sub>SEL</sub> = V <sub>ISO</sub> ).   |

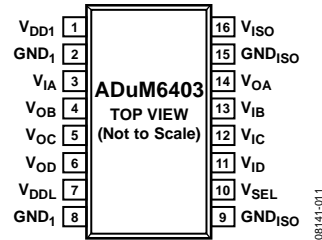

Figure 11. ADuM6403 Pin Configuration

Table 24. ADuM6403 Pin Function Descriptions

| Pin No. | Mnemonic           | Description   |
|---------|--------------------|---|
| 1       | V <sub>DD1</sub>   | Primary Supply Voltage, 3.0 V to 5.5 V. Pin 1 and Pin 7 must be connected to the same external voltage source.  |
| 2, 8    | GND <sub>1</sub>   | Ground Reference for the Primary Side of the Isolator. Pin 2 and Pin 8 are internally connected to each other, and it is recommended that both pins be connected to a common ground.              |
| 3       | V <sub>IA</sub>    | Logic Input A.  |
| 4       | V <sub>OB</sub>    | Logic Output B.   |
| 5       | V <sub>OC</sub>    | Logic Output C.   |
| 6       | V <sub>OD</sub>    | Logic Output D.   |
| 7       | V <sub>DDL</sub>   | Data Channel Supply Voltage, 3.0 V to 5.5 V. Pin 1 and Pin 7 must be connected to the same external voltage source.   |
| 9, 15   | GND <sub>ISO</sub> | Ground Reference for the Secondary Side of the Isolator. Pin 9 and Pin 15 are internally connected to each other, and it is recommended that both pins be connected to a common ground.           |
| 10      | V <sub>SEL</sub>   | Output Voltage Selection. When V <sub>SEL</sub> = V <sub>ISO</sub> , the V <sub>ISO</sub> setpoint is 5.0 V. When V <sub>SEL</sub> = GND <sub>ISO</sub> , the V <sub>ISO</sub> setpoint is 3.3 V. |
| 11      | V <sub>ID</sub>    | Logic Input D.  |
| 12      | V <sub>IC</sub>    | Logic Input C.  |
| 13      | V <sub>IB</sub>    | Logic Input B.  |
| 14      | V <sub>OA</sub>    | Logic Output A.   |
| 16      | V <sub>ISO</sub>   | Secondary Supply Voltage Output for External Loads: 3.3 V (V <sub>SEL</sub> = GND <sub>ISO</sub> ) or 5.0 V (V <sub>SEL</sub> = V <sub>ISO</sub> ).   |

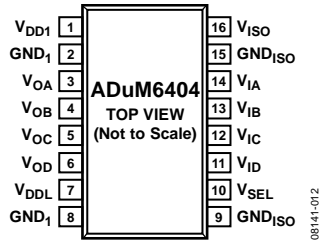

Figure 12. ADuM6404 Pin Configuration

Table 25. ADuM6404 Pin Function Descriptions

| Pin No. | Mnemonic           | Description   |
|---------|--------------------|---|
| 1       | V <sub>DD1</sub>   | Primary Supply Voltage, 3.0 V to 5.5 V. Pin 1 and Pin 7 must be connected to the same external voltage source.  |
| 2, 8    | GND <sub>1</sub>   | Ground Reference for the Primary Side of the Isolator. Pin 2 and Pin 8 are internally connected to each other, and it is recommended that both pins be connected to a common ground.              |
| 3       | V <sub>OA</sub>    | Logic Output A.   |
| 4       | V <sub>OB</sub>    | Logic Output B.   |
| 5       | V <sub>OC</sub>    | Logic Output C.   |
| 6       | V <sub>OD</sub>    | Logic Output D.   |
| 7       | V <sub>DDL</sub>   | Data Channel Supply Voltage, 3.0 V to 5.5 V. Pin 1 and Pin 7 must be connected to the same external voltage source.   |
| 9, 15   | GND <sub>ISO</sub> | Ground Reference for the Secondary Side of the Isolator. Pin 9 and Pin 15 are internally connected to each other, and it is recommended that both pins be connected to a common ground.           |
| 10      | V <sub>SEL</sub>   | Output Voltage Selection. When V <sub>SEL</sub> = V <sub>ISO</sub> , the V <sub>ISO</sub> setpoint is 5.0 V. When V <sub>SEL</sub> = GND <sub>ISO</sub> , the V <sub>ISO</sub> setpoint is 3.3 V. |
| 11      | V <sub>ID</sub>    | Logic Input D.  |
| 12      | V <sub>IC</sub>    | Logic Input C.  |
| 13      | V <sub>IB</sub>    | Logic Input B.  |
| 14      | V <sub>IA</sub>    | Logic Input A.  |
| 16      | V <sub>ISO</sub>   | Secondary Supply Voltage Output for External Loads: 3.3 V (V <sub>SEL</sub> = GND <sub>ISO</sub> ) or 5.0 V (V <sub>SEL</sub> = V <sub>ISO</sub> ).   |

## TRUTH TABLE

Table 26. Power Control Truth Table (Positive Logic)

| V <sub>SEL</sub> Input | V <sub>DD1</sub> Input | V <sub>ISO</sub> Output | Operation   |
|------------------------|------------------------|-------------------------|---|
| High                   | 5 V                    | 5 V                     | Self-regulation mode, normal operation  |
| Low                    | 5 V                    | 3.3 V                   | Self-regulation mode, normal operation  |
| Low                    | 3.3 V                  | 3.3 V                   | Self-regulation mode, normal operation  |
| High                   | 3.3 V                  | 5 V                     | This supply configuration is not recommended due to extremely poor efficiency |



TYPICAL PERFORMANCE CHARACTERISTICS

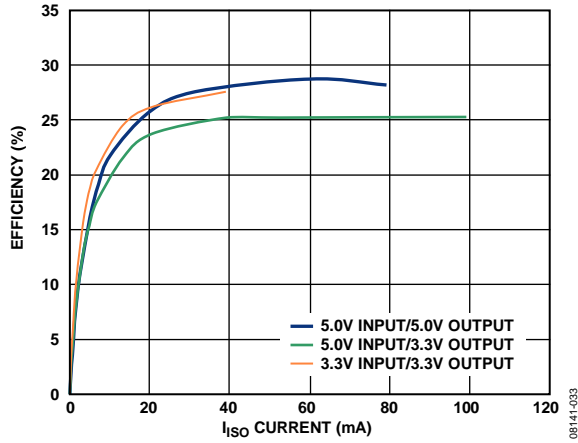

Figure 13. Typical Power Supply Efficiency in All Supported Power Configurations

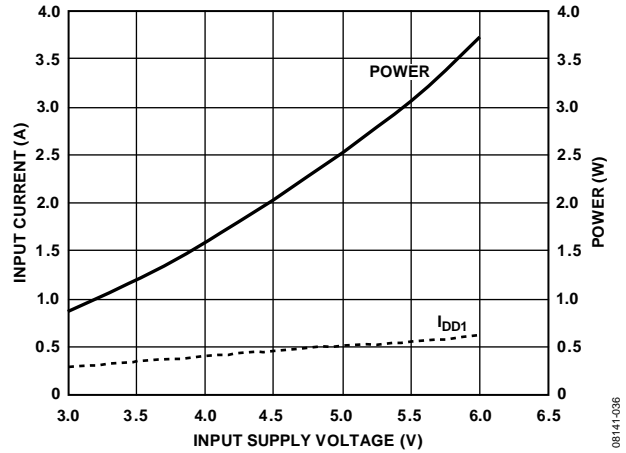

Figure 16. Typical Short-Circuit Input Current and Power vs.  $V_{DD1}$  Supply Voltage

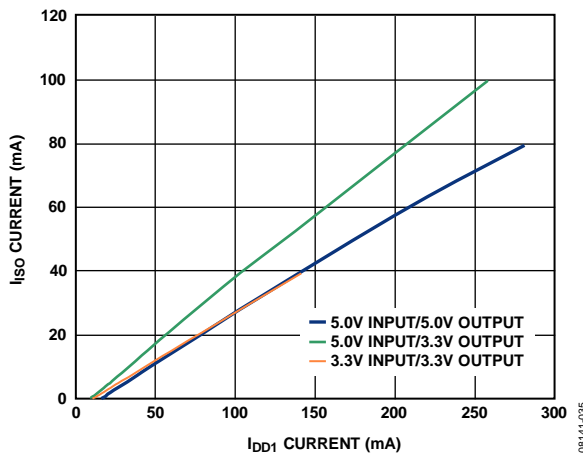

Figure 14. Typical Isolated Output Supply Current vs. Input Current in All Supported Power Configurations

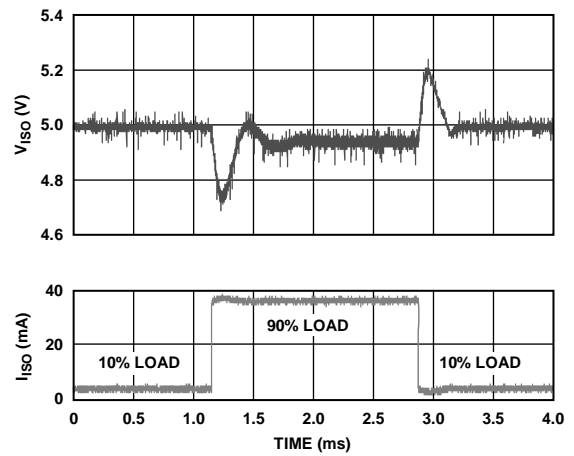

Figure 17. Typical  $V_{ISO}$  Transient Load Response, 5 V Output, 10% to 90% Load Step

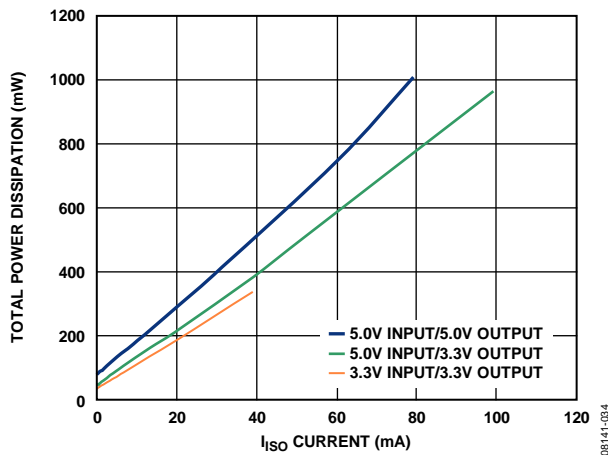

Figure 15. Typical Total Power Dissipation vs. Isolated Output Supply Current in All Supported Power Configurations

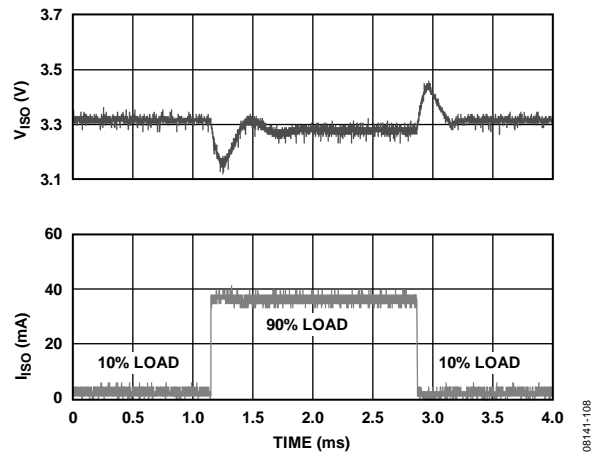

Figure 18. Typical  $V_{ISO}$  Transient Load Response, 3.3 V Output, 10% to 90% Load Step

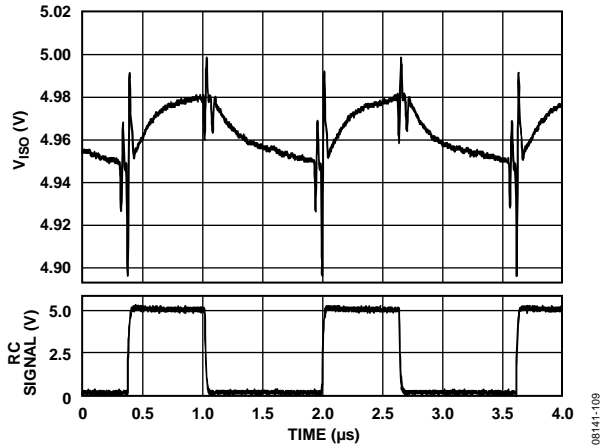

Figure 19. Typical Output Voltage Ripple at 90% Load,  $V_{ISO} = 5\text{ V}$

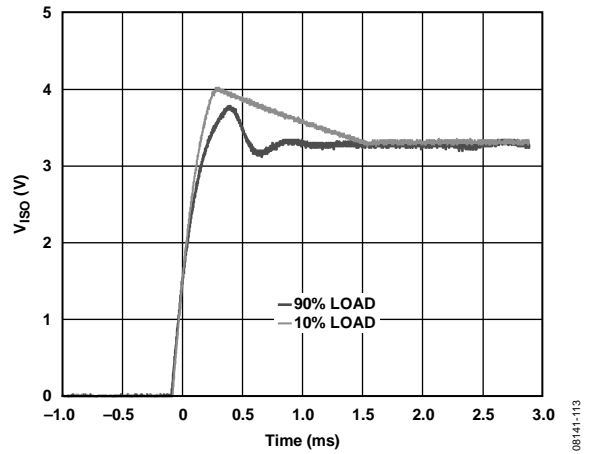

Figure 22. Typical Output Voltage Start-Up Transient at 10% and 90% Load,  $V_{ISO} = 3.3\text{ V}$

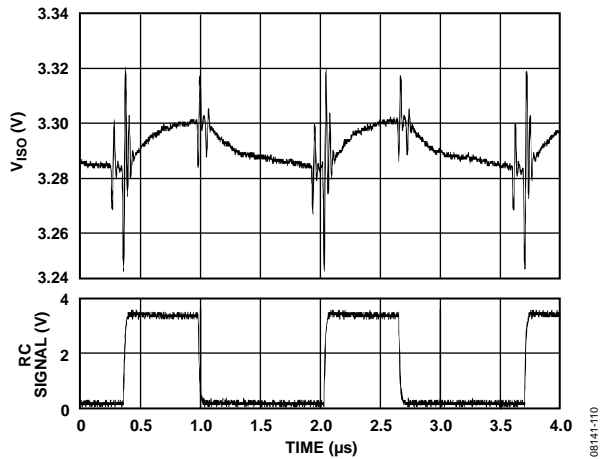

Figure 20. Typical Output Voltage Ripple at 90% Load,  $V_{ISO} = 3.3\text{ V}$

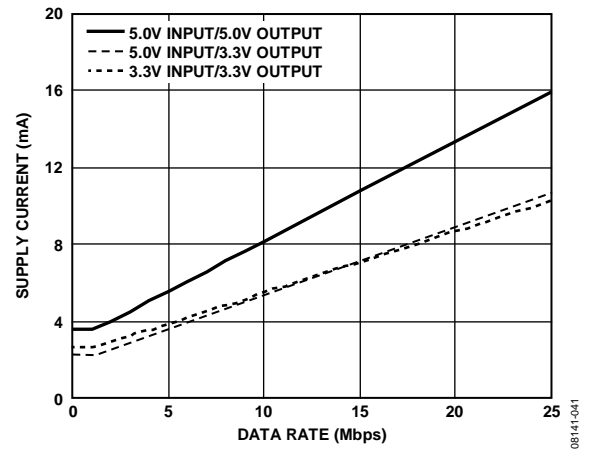

Figure 23. Typical  $I_{CHn}$  Supply Current per Forward Data Channel (15 pF Output Load)

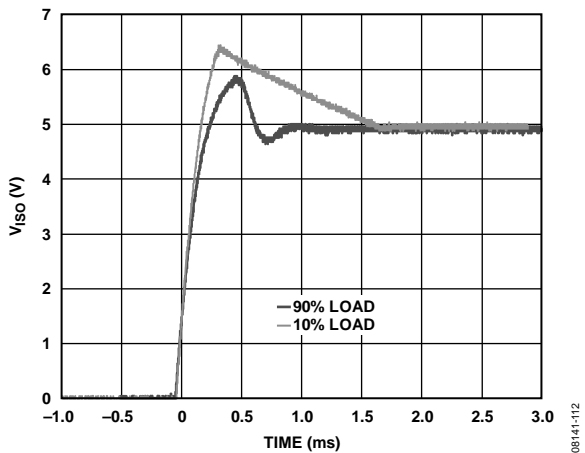

Figure 21. Typical Output Voltage Start-Up Transient at 10% and 90% Load,  $V_{ISO} = 5\text{ V}$

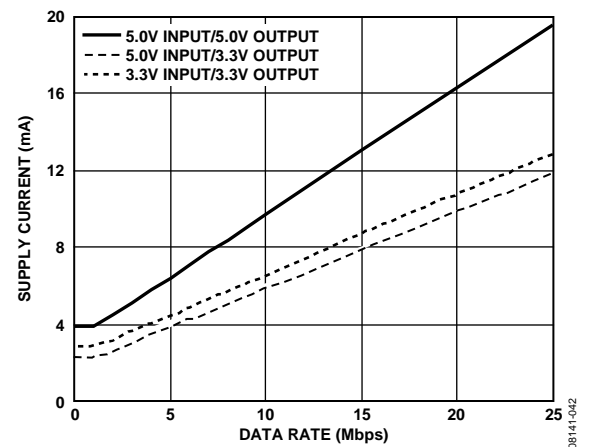

Figure 24. Typical  $I_{CHn}$  Supply Current per Reverse Data Channel (15 pF Output Load)

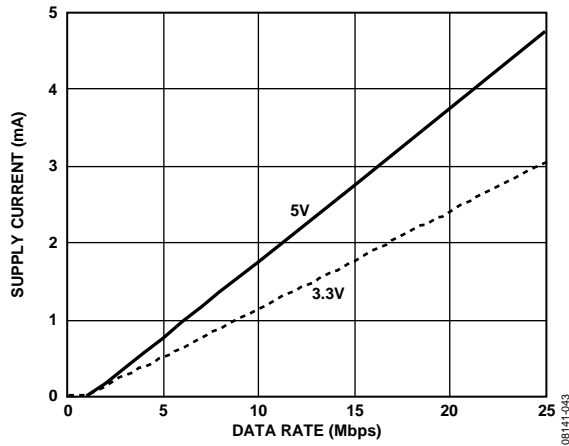

Figure 25. Typical  $I_{ISO(D)}$  Dynamic Supply Current per Input

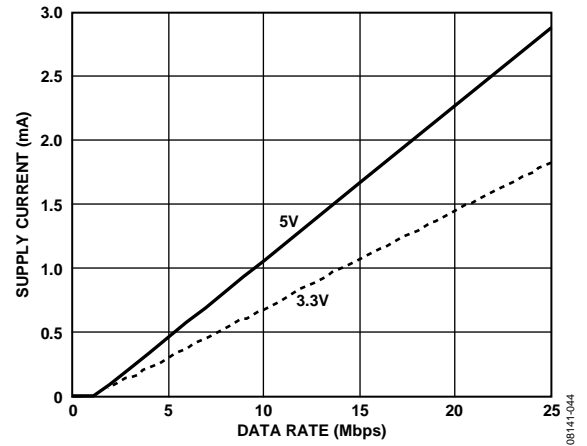

Figure 26. Typical  $I_{ISO(D)}$  Dynamic Supply Current per Output (15 pF Output Load)

## TERMINOLOGY

### $I_{DD1(Q)}$

$I_{DD1(Q)}$  is the minimum operating current drawn at the  $V_{DD1}$  pin when there is no external load at  $V_{ISO}$  and the I/O pins are operating below 2 Mbps, requiring no additional dynamic supply current.  $I_{DD1(Q)}$  reflects the minimum current operating condition.

### $I_{DD1(D)}$

$I_{DD1(D)}$  is the typical input supply current with all channels simultaneously driven at a maximum data rate of 25 Mbps with full capacitive load representing the maximum dynamic load conditions. Resistive loads on the outputs should be treated separately from the dynamic load.

### $I_{DD1(MAX)}$

$I_{DD1(MAX)}$  is the input current under full dynamic and  $V_{ISO}$  load conditions.

### $I_{ISO(LOAD)}$

$I_{ISO(LOAD)}$  is the current available to the load.

### $t_{PHL}$ Propagation Delay

The  $t_{PHL}$  propagation delay is measured from the 50% level of the falling edge of the  $V_{IX}$  signal to the 50% level of the falling edge of the  $V_{OX}$  signal.

### $t_{PLH}$ Propagation Delay

The  $t_{PLH}$  propagation delay is measured from the 50% level of the rising edge of the  $V_{IX}$  signal to the 50% level of the rising edge of the  $V_{OX}$  signal.

### Propagation Delay Skew ( $t_{PSK}$ )

$t_{PSK}$  is the magnitude of the worst-case difference in  $t_{PHL}$  and/or  $t_{PLH}$  that is measured between units at the same operating temperature, supply voltages, and output load within the recommended operating conditions.

### Channel-to-Channel Matching ( $t_{PSKCD}/t_{PSKOD}$ )

Channel-to-channel matching is the absolute value of the difference in propagation delays between two channels when operated with identical loads.

### Minimum Pulse Width

The minimum pulse width is the shortest pulse width at which the specified pulse width distortion is guaranteed.

### Maximum Data Rate

The maximum data rate is the fastest data rate at which the specified pulse width distortion is guaranteed.

## APPLICATIONS INFORMATION

The dc-to-dc converter section of the ADuM640x works on principles that are common to most switching power supplies. It has a secondary side controller architecture with isolated pulse-width modulation (PWM) feedback.  $V_{DD1}$  power is supplied to an oscillating circuit that switches current into a chip scale air core transformer. Power transferred to the secondary side is rectified and regulated to either 3.3 V or 5 V. The secondary ( $V_{ISO}$ ) side controller regulates the output by creating a PWM control signal that is sent to the primary ( $V_{DD1}$ ) side by a dedicated *iCoupler* data channel. The PWM modulates the oscillator circuit to control the power being sent to the secondary side. Feedback allows for significantly higher power and efficiency.

The ADuM640x implements undervoltage lockout (UVLO) with hysteresis on the  $V_{DD1}$  power input. This feature ensures that the converter does not enter oscillation due to noisy input power or slow power-on ramp rates.

A minimum load current of 10 mA is recommended to ensure optimum load regulation. Smaller loads can generate excess noise on chip due to short or erratic PWM pulses. Excess noise that is generated in this way can cause data corruption, in some cases.

### PCB LAYOUT

The ADuM640x digital isolators with 0.4 W *isoPower* integrated dc-to-dc converter require no external interface circuitry for the logic interfaces. Power supply bypassing is required at the input and output supply pins (see Figure 27). Note that low ESR bypass capacitors are required between Pin 1 and Pin 2 and between Pin 15 and Pin 16, as close to the chip pads as possible.

The power supply section of the ADuM640x uses a 180 MHz oscillator frequency to pass power efficiently through its chip scale transformers. In addition, the normal operation of the data section of the *iCoupler* introduces switching transients on the power supply pins. Bypass capacitors are required for several operating frequencies. Noise suppression requires a low inductance, high frequency capacitor, whereas ripple suppression and proper regulation require a large value capacitor. These capacitors are most conveniently connected between Pin 1 and Pin 2 for  $V_{DD1}$ , and between Pin 15 and Pin 16 for  $V_{ISO}$ .

To suppress noise and reduce ripple, a parallel combination of at least two capacitors is required. The recommended capacitor values are 0.1  $\mu\text{F}$  and 10  $\mu\text{F}$  for  $V_{DD1}$  and  $V_{ISO}$ . The smaller capacitor must have a low ESR; for example, use of a ceramic capacitor is advised.

The total lead length between the ends of the low ESR capacitor and the input power supply pin must not exceed 2 mm. Installing the bypass capacitor with traces more than 2 mm in length may result in data corruption. Consider bypassing between Pin 1 and Pin 8 and between Pin 9 and Pin 16 unless both common ground pins are connected together close to the package.

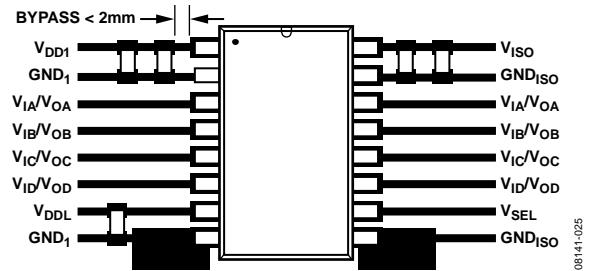

Figure 27. Recommended PCB Layout

In applications involving high common-mode transients, ensure that board coupling across the isolation barrier is minimized. Furthermore, design the board layout such that any coupling that does occur affects all pins equally on a given component side. Failure to ensure this can cause voltage differentials between pins exceeding the absolute maximum ratings for the device as specified in Table 19, thereby leading to latch-up and/or permanent damage.

The ADuM640x is a power device that dissipates approximately 1 W of power when fully loaded and running at maximum speed. Because it is not possible to apply a heat sink to an isolation device, the device primarily depends on heat dissipation into the PCB through the GND pins. If the device is used at high ambient temperatures, provide a thermal path from the GND pins to the PCB ground plane. The board layout in Figure 27 shows enlarged pads for Pin 8 ( $GND_1$ ) and Pin 9 ( $GND_{ISO}$ ). Multiple vias should be implemented from the pad to the ground plane to significantly reduce the temperature inside the chip. The dimensions of the expanded pads are at the discretion of the designer and depend on the available board space.

### START-UP BEHAVIOR

The ADuM640x devices do not contain a soft start circuit. Therefore, the start-up current and voltage behavior must be taken into account when designing with this device.

When power is applied to  $V_{DD1}$ , the input switching circuit begins to operate and draw current when the UVLO minimum voltage is reached. The switching circuit drives the maximum available power to the output until it reaches the regulation voltage where PWM control begins. The amount of current and the time required to reach regulation voltage depends on the load and the  $V_{DD1}$  slew rate.

With a fast  $V_{DD1}$  slew rate (200  $\mu\text{s}$  or less), the peak current draws up to 100 mA/V of  $V_{DD1}$ . The input voltage goes high faster than the output can turn on, so the peak current is proportional to the maximum input voltage.

With a slow  $V_{DD1}$  slew rate (in the millisecond range), the input voltage is not changing quickly when  $V_{DD1}$  reaches the UVLO minimum voltage. The current surge is approximately 300 mA because  $V_{DD1}$  is nearly constant at the 2.7 V UVLO voltage. The behavior during startup is similar to when the device load is a short circuit; these values are consistent with the short-circuit current shown in Figure 16.

When starting the device for  $V_{ISO} = 5$  V operation, do not limit the current available to the  $V_{DD1}$  power pin to less than 300 mA. The ADuM640x devices may not be able to drive the output to the regulation point if a current-limiting device clamps the  $V_{DD1}$  voltage during startup. As a result, the ADuM640x devices can draw large amounts of current at low voltage for extended periods of time.

The output voltage of the ADuM640x devices exhibits  $V_{ISO}$  overshoot during startup. If this overshoot could potentially damage components attached to  $V_{ISO}$ , a voltage-limiting device such as a Zener diode can be used to clamp the voltage. Typical behavior is shown in Figure 21 and Figure 22.

## EMI CONSIDERATIONS

The dc-to-dc converter section of the ADuM640x devices must operate at 180 MHz to allow efficient power transfer through the small transformers. This creates high frequency currents that can propagate in circuit board ground and power planes, causing edge emissions and dipole radiation between the primary and secondary ground planes. Grounded enclosures are recommended for applications that use these devices. If grounded enclosures are not possible, follow good RF design practices in the layout of the PCB. See the AN-0971 Application Note for board layout recommendations.

## PROPAGATION DELAY PARAMETERS

Propagation delay is a parameter that describes the time it takes a logic signal to propagate through a component. The propagation delay to a logic low output may differ from the propagation delay to a logic high output.

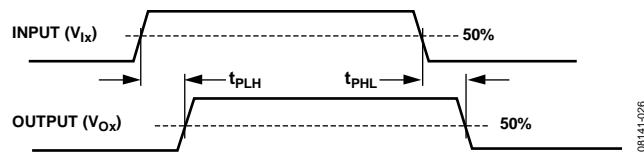

Figure 28. Propagation Delay Parameters

Pulse width distortion is the maximum difference between these two propagation delay values and is an indication of how accurately the timing of the input signal is preserved.

Channel-to-channel matching refers to the maximum amount that the propagation delay differs between channels within a single ADuM640x component.

Propagation delay skew refers to the maximum amount that the propagation delay differs between multiple ADuM640x components operating under the same conditions.

## DC CORRECTNESS AND MAGNETIC FIELD IMMUNITY

Positive and negative logic transitions at the isolator input cause narrow ( $\sim 1$  ns) pulses to be sent to the decoder via the transformer. The decoder is bistable and is, therefore, either set or reset by the pulses, indicating input logic transitions. In the absence of logic transitions at the input for more than 1  $\mu$ s, a periodic set of refresh pulses indicative of the correct input state is sent to ensure dc correctness at the output. If the decoder receives no internal pulses for more than approximately 5  $\mu$ s, the input side is assumed to be unpowered or nonfunctional, and the isolator output is forced to a default state by the watchdog timer circuit. This situation should occur in the ADuM640x devices only during power-up and power-down operations.

The limitation on the magnetic field immunity of the ADuM640x is set by the condition in which induced voltage in the receiving coil of the transformer is sufficiently large to either falsely set or reset the decoder. The following analysis defines the conditions under which this may occur. The 3.3 V operating condition of the ADuM640x is examined because it represents the most susceptible mode of operation.

The pulses at the transformer output have an amplitude greater than 1.0 V. The decoder has a sensing threshold at approximately 0.5 V, thus establishing a 0.5 V margin in which induced voltages can be tolerated. The voltage induced across the receiving coil is given by

$$V = (-d\beta/dt) \sum \pi r_n^2; n = 1, 2, \dots, N$$

where:

$\beta$  is the magnetic flux density (gauss).

$r_n$  is the radius of the  $n^{\text{th}}$  turn in the receiving coil (cm).

$N$  is the total number of turns in the receiving coil.

Given the geometry of the receiving coil in the ADuM640x and an imposed requirement that the induced voltage be, at most, 50% of the 0.5 V margin at the decoder, a maximum allowable magnetic field is calculated as shown in Figure 29.

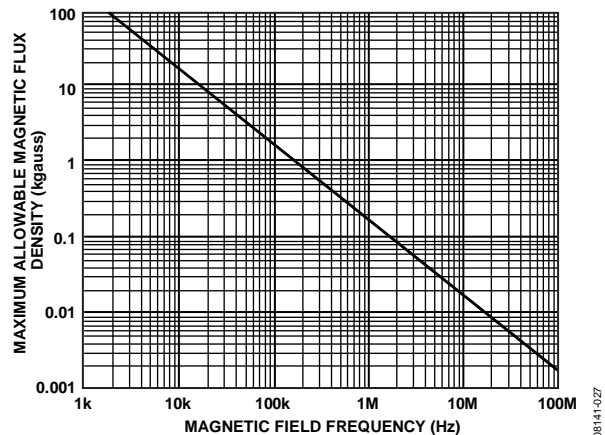

Figure 29. Maximum Allowable External Magnetic Flux Density

For example, at a magnetic field frequency of 1 MHz, the maximum allowable magnetic field of 0.2 kgauss induces a voltage of 0.25 V at the receiving coil. This voltage is approximately 50% of the sensing threshold and does not cause a faulty output transition. Similarly, if such an event occurs during a transmitted pulse (and is of the worst-case polarity), it reduces the received pulse from >1.0 V to 0.75 V—still well above the 0.5 V sensing threshold of the decoder.

The preceding magnetic flux density values correspond to specific current magnitudes at given distances from the ADuM640x transformers. Figure 30 expresses these allowable current magnitudes as a function of frequency for selected distances. As shown in Figure 30, the ADuM640x is extremely immune and can be affected only by extremely large currents operated at high frequency very close to the component. For the 1 MHz example noted, a 0.5 kA current placed 5 mm away from the ADuM640x is required to affect the operation of the device.

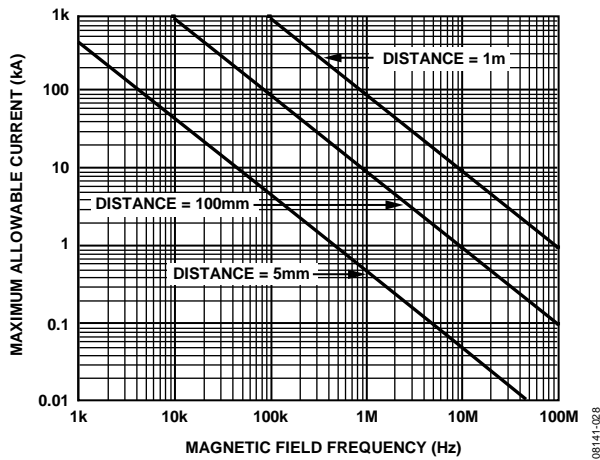

Figure 30. Maximum Allowable Current for Various Current-to-ADuM640x Spacings

Note that at combinations of strong magnetic field and high frequency, any loops formed by PCB traces can induce error voltages sufficiently large to trigger the thresholds of succeeding circuitry. Exercise care in the layout of such traces to avoid this possibility.

**POWER CONSUMPTION**

The V<sub>DD1</sub> power supply input provides power to the iCoupler data channels as well as to the power converter. For this reason, the quiescent currents drawn by the data converter and the primary and secondary input/output channels cannot be determined separately. All of these quiescent power demands are combined into the I<sub>DD1(Q)</sub> current shown in Figure 31. The total I<sub>DD1</sub> supply current is the sum of the quiescent operating current, the dynamic current I<sub>DD1(D)</sub> demanded by the I/O channels, and any external I<sub>ISO</sub> load.

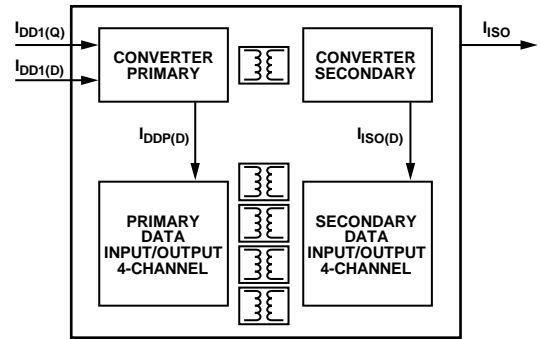

Figure 31. Power Consumption Within the ADuM640x

Both dynamic input and output current is consumed only when operating at channel speeds higher than the refresh rate, f. Each channel has a dynamic current determined by its data rate. Figure 23 shows the current for a channel in the forward direction, which means that the input is on the primary side of the part. Figure 24 shows the current for a channel in the reverse direction, which means that the input is on the secondary side of the part. Both figures assume a typical 15 pF load. The following relationship allows the total I<sub>DD1</sub> current to be calculated:

$$I_{DD1} = (I_{ISO} \times V_{ISO}) / (E \times V_{DD1}) + \sum I_{CHn}; n = 1 \text{ to } 4 \tag{1}$$

where:

- I<sub>DD1</sub> is the total supply input current.
- I<sub>ISO</sub> is the current drawn by the secondary side external loads.
- E is the power supply efficiency at the maximum load from Figure 13 at the V<sub>ISO</sub> and V<sub>DD1</sub> condition of interest.
- I<sub>CHn</sub> is the current drawn by a single channel, determined from Figure 23 or Figure 24, depending on channel direction.

Calculate the maximum external load by subtracting the dynamic output load from the maximum allowable load.

$$I_{ISO(LOAD)} = I_{ISO(MAX)} - \sum I_{ISO(D)n}; n = 1 \text{ to } 4 \tag{2}$$

where:

- I<sub>ISO(LOAD)</sub> is the current available to supply an external secondary side load.
- I<sub>ISO(MAX)</sub> is the maximum external secondary side load current available at V<sub>ISO</sub>.
- I<sub>ISO(D)n</sub> is the dynamic load current drawn from V<sub>ISO</sub> by an input or output channel, as shown in Figure 23 and Figure 24 for a typical 15 pF load.

This analysis assumes a 15 pF capacitive load on each data output. If the capacitive load is larger than 15 pF, the additional current must be included in the analysis of I<sub>DD1</sub> and I<sub>ISO(LOAD)</sub>.

To determine I<sub>DD1</sub> in Equation 1, additional primary side dynamic output current (I<sub>AOD</sub>) is added directly to I<sub>DD1</sub>. Additional secondary side dynamic output current (I<sub>AOD</sub>) is added to I<sub>ISO</sub> on a per-channel basis.

To determine I<sub>ISO(LOAD)</sub> in Equation 2, additional secondary side output current (I<sub>AOD</sub>) is subtracted from I<sub>ISO(MAX)</sub> on a per-channel basis.

For each output channel with  $C_L$  greater than 15 pF, the additional capacitive supply current is given by

$$I_{AOD} = 0.5 \times 10^{-3} \times ((C_L - 15) \times V_{ISO}) \times (2f - f_r); f > 0.5 f_r \quad (3)$$

where:

$C_L$  is the output load capacitance (pF).

$V_{ISO}$  is the output supply voltage (V).

$f$  is the input logic signal frequency (MHz); it is half the input data rate expressed in units of Mbps.

$f_r$  is the input channel refresh rate (Mbps).

## CURRENT LIMIT AND THERMAL OVERLOAD PROTECTION

The ADuM640x is protected against damage due to excessive power dissipation by thermal overload protection circuits. Thermal overload protection limits the junction temperature to a maximum of 150°C (typical). Under extreme conditions (that is, high ambient temperature and power dissipation), when the junction temperature starts to rise above 150°C, the PWM is turned off, turning off the output current. When the junction temperature drops below 130°C (typical), the PWM turns on again, restoring the output current to its nominal value.

Consider the case where a hard short from  $V_{ISO}$  to ground occurs. At first, the ADuM640x reaches its maximum current, which is proportional to the voltage applied at  $V_{DD1}$ . Power dissipates on the primary side of the converter (see Figure 16). If self-heating of the junction becomes great enough to cause its temperature to rise above 150°C, thermal shutdown is activated, turning off the PWM and turning off the output current. As the junction temperature cools and drops below 130°C, the PWM turns on and power dissipates again on the primary side of the converter, causing the junction temperature to rise to 150°C again. This thermal oscillation between 130°C and 150°C causes the part to cycle on and off as long as the short remains at the output.

Thermal limit protections are intended to protect the device against accidental overload conditions. For reliable operation, externally limit device power dissipation to prevent junction temperatures from exceeding 130°C.

## POWER CONSIDERATIONS

The ADuM6400/ADuM6401/ADuM6402/ADuM6403/ADuM6404 power input, data input channels on the primary side, and data input channels on the secondary side are all protected from premature operation by undervoltage lockout (UVLO) circuitry. Below the minimum operating voltage, the power converter holds its oscillator inactive, and all input channel drivers and refresh circuits are idle. Outputs remain in a high impedance state to prevent transmission of undefined states during power-up and power-down operations.

During application of power to  $V_{DD1}$ , the primary side circuitry is held idle until the UVLO preset voltage is reached. At that time, the data channels initialize to their default low output state until they receive data pulses from the secondary side.

When the primary side is above the UVLO threshold, the data input channels sample their inputs and begin sending encoded pulses to the inactive secondary output channels. The outputs on the primary side remain in their default low state because no data comes from the secondary side inputs until secondary side power is established. The primary side oscillator also begins to operate, transferring power to the secondary power circuits.

The secondary  $V_{ISO}$  voltage is below its UVLO limit at this point; the regulation control signal from the secondary side is not being generated. The primary side power oscillator is allowed to free run under these conditions, supplying the maximum amount of power to the secondary side.

As the secondary side voltage rises to its regulation setpoint, a large inrush current transient is present at  $V_{DD1}$ . When the regulation point is reached, the regulation control circuit produces the regulation control signal that modulates the oscillator on the primary side. The  $V_{DD1}$  current is then reduced and is proportional to the load current. The inrush current is less than the short-circuit current shown in Figure 16. The duration of the inrush current depends on the  $V_{ISO}$  loading conditions and on the current and voltage available at the  $V_{DD1}$  pin.

As the secondary side converter begins to accept power from the primary, the  $V_{ISO}$  voltage starts to rise. When the secondary side UVLO is reached, the secondary side outputs are initialized to their default low state until data is received from the corresponding primary side input. It can take up to 1  $\mu$ s after the secondary side is initialized for the state of the output to correlate to the primary side input.

Secondary side inputs sample their state and transmit it to the primary side. Outputs are valid about 1  $\mu$ s after the secondary side becomes active.

Because the rate of charge of the secondary side power supply is dependent on loading conditions, the input voltage, and the output voltage level selected, take care that the design allows the converter sufficient time to stabilize before valid data is required.

When power is removed from  $V_{DD1}$ , the primary side converter and coupler shut down when the UVLO level is reached. The secondary side stops receiving power and starts to discharge.

The outputs on the secondary side hold the last state that they received from the primary side. Either the UVLO level is reached and the outputs are placed in their high impedance state, or the outputs detect a lack of activity from the primary side inputs and the outputs are set to their default low value before the secondary power reaches UVLO.



## THERMAL ANALYSIS

The ADuM640x devices consist of four internal silicon die attached to a split lead frame with two die attach paddles. For the purposes of thermal analysis, the device is treated as a thermal unit with the highest junction temperature reflected in the  $\theta_{JA}$  value from Table 14. The value of  $\theta_{JA}$  is based on measurements taken with the part mounted on a JEDEC standard 4-layer board with fine width traces and still air. Under normal operating conditions, the ADuM640x operates at full load across the full temperature range without derating the output current. However, following the recommendations in the PCB Layout section decreases the thermal resistance to the PCB, allowing increased thermal margin at high ambient temperatures.

## INSULATION LIFETIME

All insulation structures eventually break down when subjected to voltage stress over a sufficiently long period. The rate of insulation degradation is dependent on the characteristics of the voltage waveform applied across the insulation. In addition to the testing performed by the regulatory agencies, Analog Devices carries out an extensive set of evaluations to determine the lifetime of the insulation structure within the ADuM640x devices.

Analog Devices performs accelerated life testing using voltage levels higher than the rated continuous working voltage. Acceleration factors for several operating conditions are determined. These factors allow calculation of the time to failure at the actual working voltage. The values shown in Table 20 summarize the peak voltage for 50 years of service life for a bipolar ac operating condition and the maximum CSA/VDE approved working voltages. In many cases, the approved working voltage is higher than the 50-year service life voltage. Operation at these high working voltages can lead to shortened insulation life in some cases.

The insulation lifetime of the ADuM640x devices depends on the voltage waveform type imposed across the isolation barrier. The iCoupler insulation structure degrades at different rates depending on whether the waveform is bipolar ac, unipolar ac, or dc. Figure 32, Figure 33, and Figure 34 illustrate these different isolation voltage waveforms.

Bipolar ac voltage is the most stringent environment. The goal of a 50-year operating lifetime under the bipolar ac condition determines the maximum working voltage recommended by Analog Devices.

In the case of unipolar ac or dc voltage, the stress on the insulation is significantly lower. This allows operation at higher working voltages while still achieving a 50-year service life. The working voltages listed in Table 20 can be applied while maintaining the 50-year minimum lifetime, provided that the voltage conforms to either the unipolar ac or dc voltage cases.

Any cross-insulation voltage waveform that does not conform to Figure 33 or Figure 34 should be treated as a bipolar ac waveform and its peak voltage limited to the 50-year lifetime voltage value listed in Table 20. The voltage presented in Figure 33 is shown as sinusoidal for illustration purposes only. It is meant to represent any voltage waveform varying between 0 V and some limiting value. The limiting value can be positive or negative, but the voltage cannot cross 0 V.

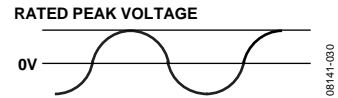

Figure 32. Bipolar AC Waveform

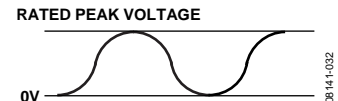

Figure 33. Unipolar AC Waveform

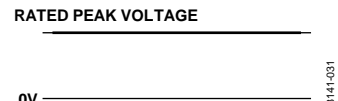
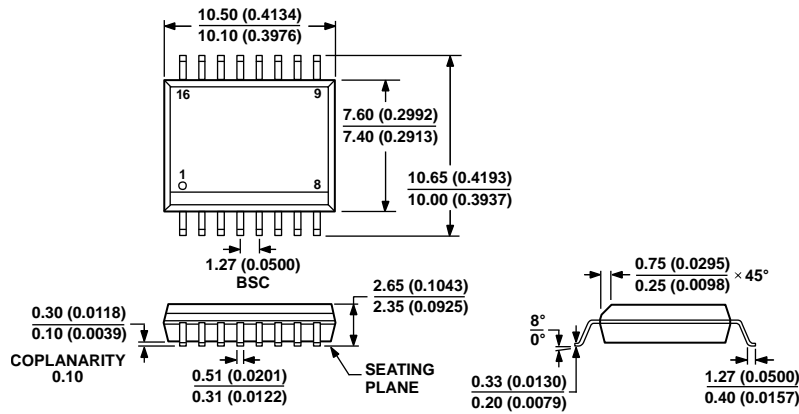

Figure 34. DC Waveform

OUTLINE DIMENSIONS



COMPLIANT TO JEDEC STANDARDS MS-013-AA  
 CONTROLLING DIMENSIONS ARE IN MILLIMETERS; INCH DIMENSIONS  
 (IN PARENTHESES) ARE ROUNDED-OFF MILLIMETER EQUIVALENTS FOR  
 REFERENCE ONLY AND ARE NOT APPROPRIATE FOR USE IN DESIGN.

Figure 35. 16-Lead Standard Small Outline Package [SOIC\_W]  
 Wide Body  
 (RW-16)

Dimensions shown in millimeters and (inches)

03-27-2007-B

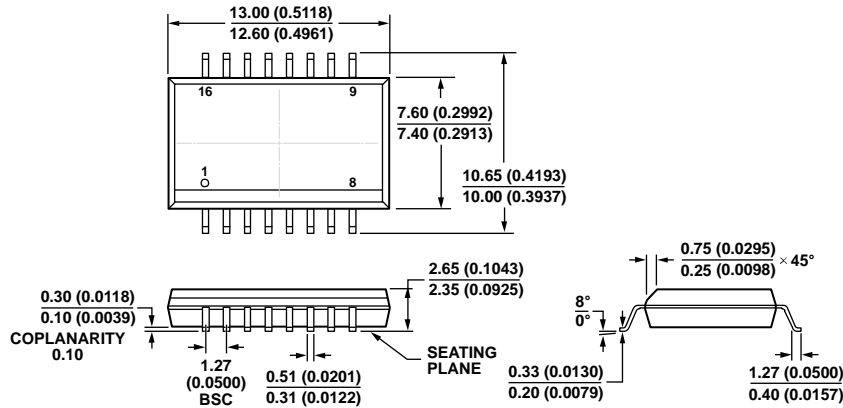

COMPLIANT TO JEDEC STANDARDS MS-013-AC  
 CONTROLLING DIMENSIONS ARE IN MILLIMETERS; INCH DIMENSIONS  
 (IN PARENTHESES) ARE ROUNDED-OFF MILLIMETER EQUIVALENTS FOR  
 REFERENCE ONLY AND ARE NOT APPROPRIATE FOR USE IN DESIGN.

Figure 36. 16-Lead Standard Small Outline Package, with Increased Creepage [SOIC\_IC]  
 Wide Body  
 (RI-16-1)

Dimensions shown in millimeters and (inches)

10-12-2010-A

## ORDERING GUIDE

| Model <sup>1,2</sup> | Number of Inputs, V <sub>DD1</sub> Side | Number of Inputs, V <sub>ISO</sub> Side | Maximum Data Rate (Mbps) | Maximum Propagation Delay, 5 V (ns) | Maximum Pulse Width Distortion (ns) | Temperature Range | Package Description | Package Option |
|----------------------|---|---|--------------------------|-------------------------------------|-------------------------------------|-------------------|---------------------|----------------|
| ADuM6400ARWZ         | 4                                       | 0                                       | 1                        | 100                                 | 40                                  | -40°C to +105°C   | 16-Lead SOIC_W      | RW-16          |
| ADuM6400CRWZ         | 4                                       | 0                                       | 25                       | 60                                  | 6                                   | -40°C to +105°C   | 16-Lead SOIC_W      | RW-16          |
| ADuM6401ARWZ         | 3                                       | 1                                       | 1                        | 100                                 | 40                                  | -40°C to +105°C   | 16-Lead SOIC_W      | RW-16          |
| ADuM6401CRWZ         | 3                                       | 1                                       | 25                       | 60                                  | 6                                   | -40°C to +105°C   | 16-Lead SOIC_W      | RW-16          |
| ADuM6402ARWZ         | 2                                       | 2                                       | 1                        | 100                                 | 40                                  | -40°C to +105°C   | 16-Lead SOIC_W      | RW-16          |
| ADuM6402CRWZ         | 2                                       | 2                                       | 25                       | 60                                  | 6                                   | -40°C to +105°C   | 16-Lead SOIC_W      | RW-16          |
| ADuM6403ARWZ         | 1                                       | 3                                       | 1                        | 100                                 | 40                                  | -40°C to +105°C   | 16-Lead SOIC_W      | RW-16          |
| ADuM6403CRWZ         | 1                                       | 3                                       | 25                       | 60                                  | 6                                   | -40°C to +105°C   | 16-Lead SOIC_W      | RW-16          |
| ADuM6404ARWZ         | 0                                       | 4                                       | 1                        | 100                                 | 40                                  | -40°C to +105°C   | 16-Lead SOIC_W      | RW-16          |
| ADuM6404CRWZ         | 0                                       | 4                                       | 25                       | 60                                  | 6                                   | -40°C to +105°C   | 16-Lead SOIC_W      | RW-16          |
| ADuM6400ARIZ         | 4                                       | 0                                       | 1                        | 100                                 | 40                                  | -40°C to +105°C   | 16-Lead SOIC_IC     | RI-16-1        |
| ADuM6400CRIZ         | 4                                       | 0                                       | 25                       | 60                                  | 6                                   | -40°C to +105°C   | 16-Lead SOIC_IC     | RI-16-1        |
| ADuM6401ARIZ         | 3                                       | 1                                       | 1                        | 100                                 | 40                                  | -40°C to +105°C   | 16-Lead SOIC_IC     | RI-16-1        |
| ADuM6401CRIZ         | 3                                       | 1                                       | 25                       | 60                                  | 6                                   | -40°C to +105°C   | 16-Lead SOIC_IC     | RI-16-1        |
| ADuM6402ARIZ         | 2                                       | 2                                       | 1                        | 100                                 | 40                                  | -40°C to +105°C   | 16-Lead SOIC_IC     | RI-16-1        |
| ADuM6402CRIZ         | 2                                       | 2                                       | 25                       | 60                                  | 6                                   | -40°C to +105°C   | 16-Lead SOIC_IC     | RI-16-1        |
| ADuM6403ARIZ         | 1                                       | 3                                       | 1                        | 100                                 | 40                                  | -40°C to +105°C   | 16-Lead SOIC_IC     | RI-16-1        |
| ADuM6403CRIZ         | 1                                       | 3                                       | 25                       | 60                                  | 6                                   | -40°C to +105°C   | 16-Lead SOIC_IC     | RI-16-1        |
| ADuM6404ARIZ         | 0                                       | 4                                       | 1                        | 100                                 | 40                                  | -40°C to +105°C   | 16-Lead SOIC_IC     | RI-16-1        |
| ADuM6404CRIZ         | 0                                       | 4                                       | 25                       | 60                                  | 6                                   | -40°C to +105°C   | 16-Lead SOIC_IC     | RI-16-1        |

<sup>1</sup> Z = RoHS Compliant Part.

<sup>2</sup> Tape and reel are available. The additional -RL suffix designates a 13-inch (1,000 units) tape and reel option.

## NOTES

## X-ON Electronics

Largest Supplier of Electrical and Electronic Components

*Click to view similar products for [Digital Isolators](#) category:*

*Click to view products by [Analog Devices](#) manufacturer:*

Other Similar products are found below :

[ADUM1280WARZ](#) [ADUM1442ARSZ-RL7](#) [ADUM1445ARSZ-RL7](#) [ADUM1280WCRZ](#) [ADUM231E1BRIZ-RL](#) [MAX14850AEE+T](#)  
[SI8380P-IUR](#) [MAX12931FASA+](#) [ADUM3211TRZ-EP-RL7](#) [ADP1032ACPZ-2-R7](#) [ADUM7223ACCZ-R7](#) [ADP1032ACPZ-4-R7](#)  
[ADP1032ACPZ-1-R7](#) [ADP1032ACPZ-5-R7](#) [ADP1032ACPZ-3-R7](#) [ADUM3301WARWZ](#) [SI8388P-IUR](#) [ADUM141E0WBRQZ-RL7](#)  
[ADUM141E0WBRQZ](#) [ADN4651BRWZ-RL7](#) [ADUM1246ARZ-RL7](#) [ADUM1201AR-RL7](#) [140U30](#) [SI8642EA-B-IU](#) [MCP2022A-330E/ST](#)  
[MCP2022A-500E/ST](#) [MCP2021-500E/P](#) [MCW1001A-I/SS](#) [IL260-1E](#) [IL260VE](#) [IL261-1E](#) [IL261VE](#) [IL262E](#) [IL3122-3E](#) [IL3122E](#) [IL3185-](#)  
[3E](#) [IL3485-3E](#) [IL3685E](#) [IL511-1E](#) [IL514E](#) [IL515E](#) [IL610A-1E](#) [IL611-1E](#) [IL612A-3E](#) [IL710-1E](#) [IL710S-1E](#) [IL711-1E](#) [IL711-2E](#) [IL716E](#)  
[IL717-1E](#)