

**TELEDYNE  
RELAYS**

A Teledyne Technologies Company



**BROADBAND  
HIGH REPEATABILITY  
TO-5 RELAY  
SPDT  
DC-8 GHz**

**SERIES  
RF311  
RF331**

SERIES DESIGNATION	RELAY TYPE
RF311	SPDT RF TO-5 relay
RF331	Sensitive, SPDT RF TO-5 relay

**INTERNAL CONSTRUCTION**

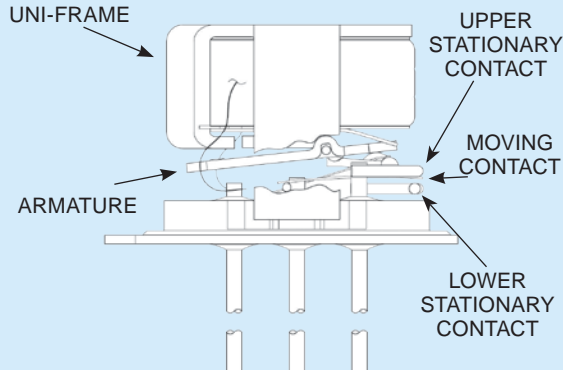

**PERFORMANCE FEATURES**

The ultraminiature RF311 and RF331 relays are designed to provide improved RF signal repeatability over the frequency range. These relays are highly suitable for use in attenuator and other RF circuits. The RF311 and RF331 feature:

- High repeatability.
- Exceptional bandwidth.
- Metal enclosure for EMI shielding.
- Ground pin option to improve case grounding.
- High isolation between control and signal paths.
- Highly resistant to ESD.

ENVIRONMENTAL AND PHYSICAL SPECIFICATIONS		
<b>Temperature</b> (Ambient)	<b>Storage</b>	-65°C to +125°C
	<b>Operating</b>	-55°C to +85°C
<b>Vibration</b> (General Note 1)		10 g's to 500 Hz
<b>Shock</b> (General Note 1)		30 g's, 6ms half sine
<b>Enclosure</b>		Hermetically sealed
<b>Weight</b>	<b>RF311</b>	0.089 oz. (2.52g) max.
	<b>RF331</b>	0.109 oz. (3.09g) max.

**CONSTRUCTION FEATURES**

The following unique construction features and manufacturing techniques provide excellent resistance to environmental extremes and overall high reliability:

- Uni-frame motor design provides high magnetic efficiency and mechanical rigidity.
- Minimum mass components and welded construction provide maximum resistance to shock and vibration.
- Advanced cleaning techniques provide maximum assurance of internal cleanliness.
- Gold-plated precious metal alloy contacts ensure reliable switching.
- Hermetically sealed.
- RoHS compliant.

**SERIES RF311 AND RF331**  
**GENERAL ELECTRICAL SPECIFICATIONS (@25°C unless otherwise noted) (Notes 2 & 3)**

<b>Contact Arrangement</b>	1 Form C (SPDT)
<b>Rated Duty</b>	Continuous
<b>Contact Resistance</b>	0.15 Ω max. initial (measured 1/8" (3.2mm) from header)
<b>Contact Load Ratings (DC)</b>	Resistive: 1A @ 28V dc Low level: 10 to 50 μA @ 10 to 50 mV
<b>Contact Life Ratings</b>	10,000,000 cycles (typical) at low level
<b>Coil Operating Power</b>	RF311: 350 mW typical @ nominal rated voltage RF331: 185 mW typical @ nominal rated voltage
<b>Operate Time</b>	RF311: 4.0 mS max. RF331: 6.0 mS max.
<b>Release Time</b>	RF311: 3.0 mS max. RF331: 3.0 mS max.
<b>Intercontact Capacitance</b>	0.4 pf typical
<b>Insulation Resistance</b>	1,000 MΩ min. between mutually isolated terminals
<b>Dielectric Strength</b>	Atmospheric pressure: 350 Vrms (60 Hz)

**DETAILED ELECTRICAL SPECIFICATIONS (@25°C)**

BASE PART NUMBERS		RF311-5/RF331-5	RF311-12/RF331-12	RF311-26/RF331-26
<b>Coil Voltage (Vdc)</b>	<b>Nom.</b>	5.0	12.0	26.5
<b>Coil Resistance (Ohms ±20%)</b>	<b>RF311</b>	63	500	2000
	<b>RF331</b>	125	1025	4000
<b>Pick-up Voltage (Vdc max.)</b>	<b>RF311</b>	3.6	9.0	18.0
	<b>RF331</b>	3.6	9.0	18.0

**OUTLINE DIMENSIONS**

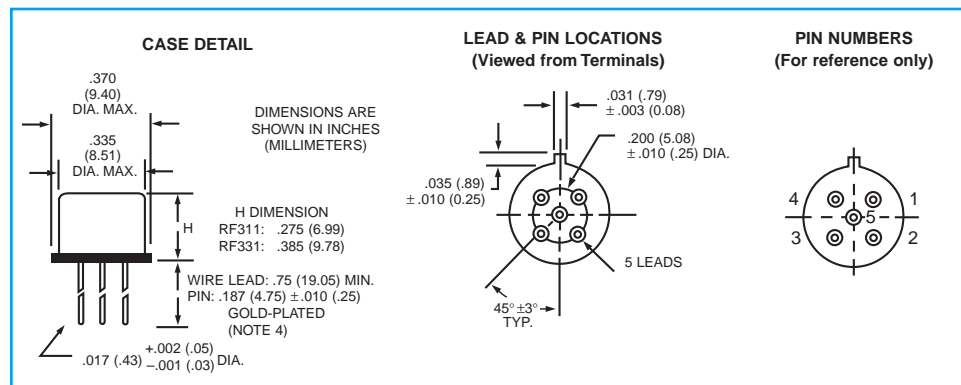

**SCHEMATIC DIAGRAM (TERMINAL VIEW)**

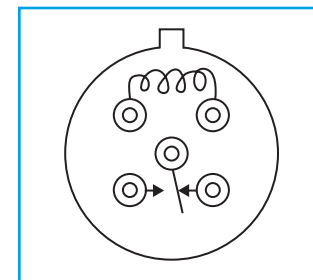

**GENERAL NOTES**

1. Relay contacts will exhibit no chatter in excess of 10 μsec or transfer in excess of 1 μsec.
2. "Typical" characteristics are based on available data and are best estimates. No on-going verification tests are performed.
3. Unless otherwise specified, parameters are initial values.
4. Leads are 0.75" standard. To order 0.187" leads, add /S to the base part number.  
**Ex. RF311-5/S.**

**SERIES RF311 AND RF331  
TYPICAL RF CHARACTERISTICS**

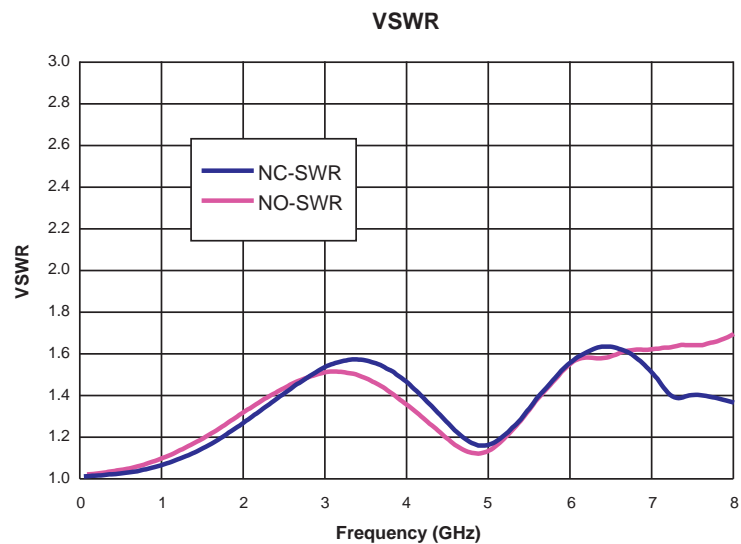
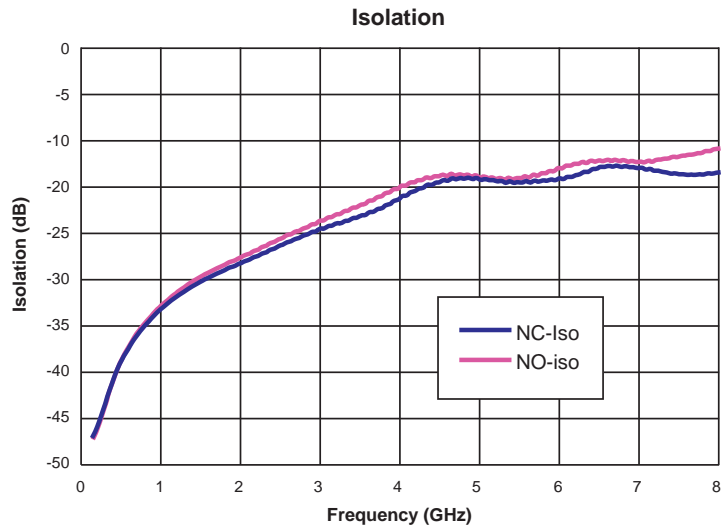
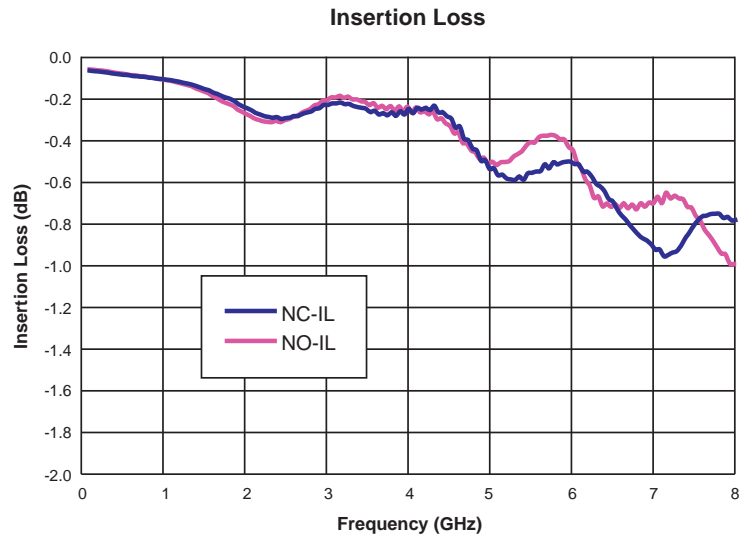

**SERIES RF311 AND RF331  
TYPICAL RF CHARACTERISTICS**

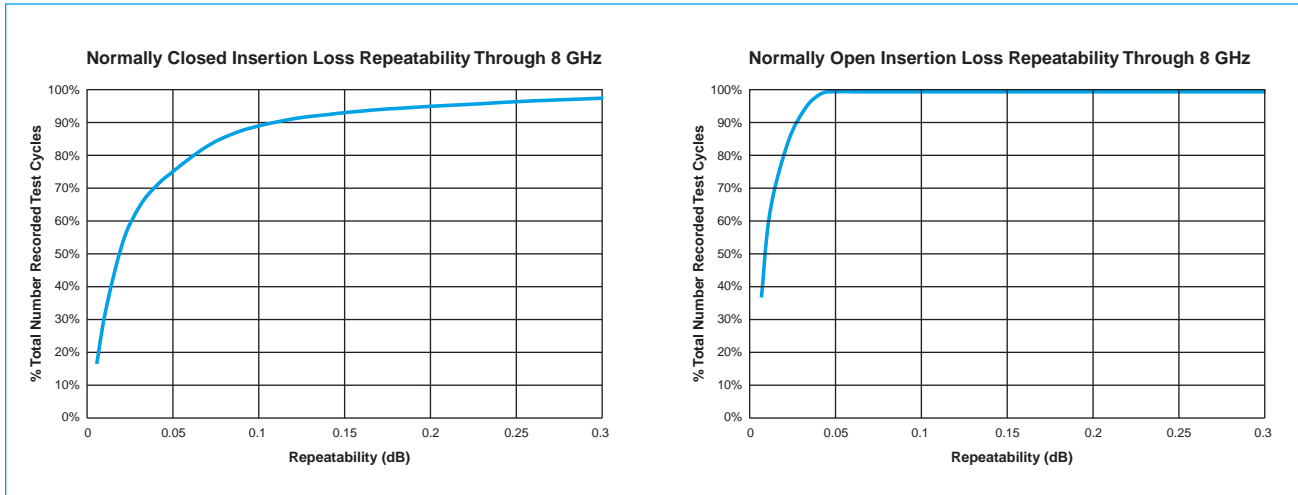

**SERIES RF311 AND RF331  
TYPICAL TIME DOMAIN CHARACTERISTICS**

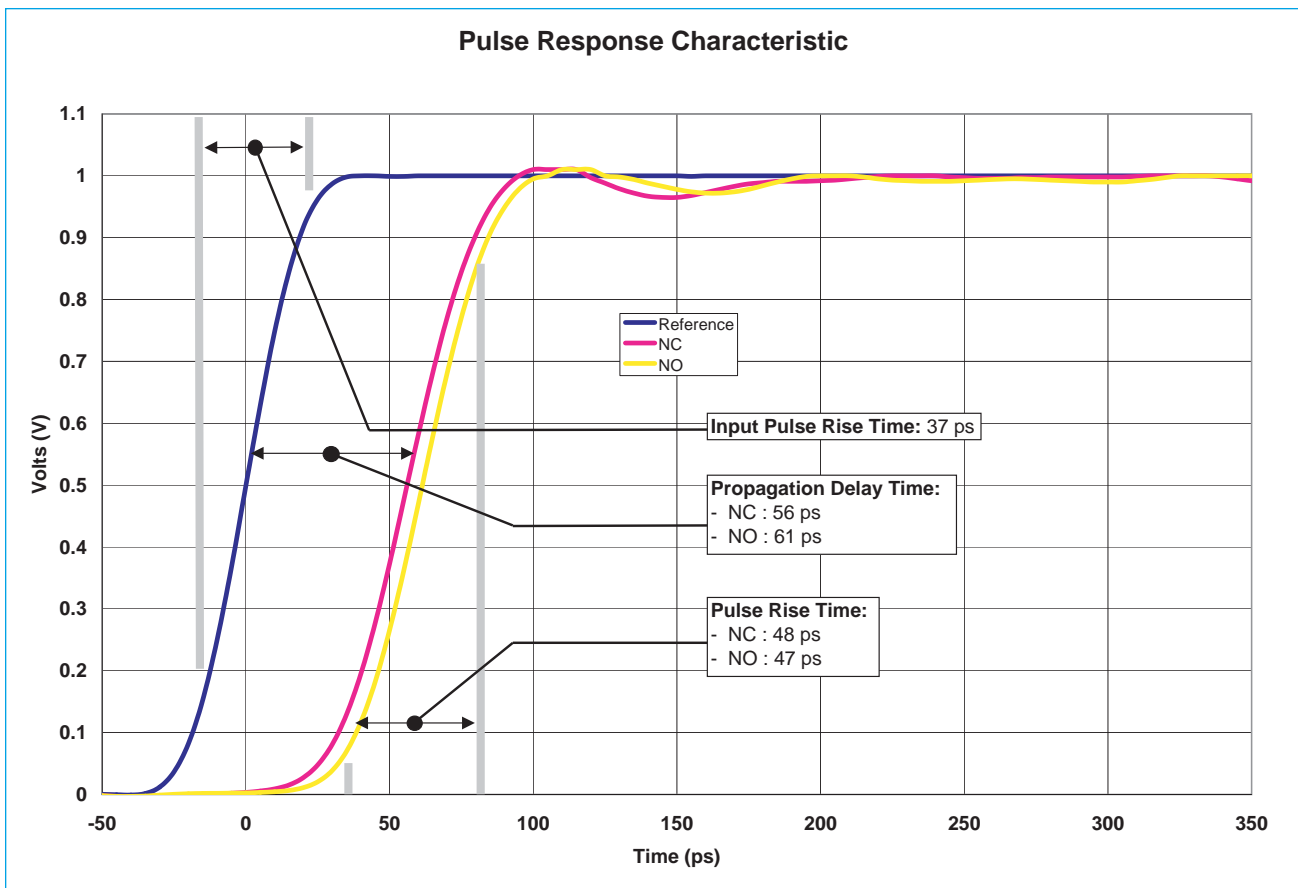

**SERIES RF311 AND RF331  
SMITH CHARTS**

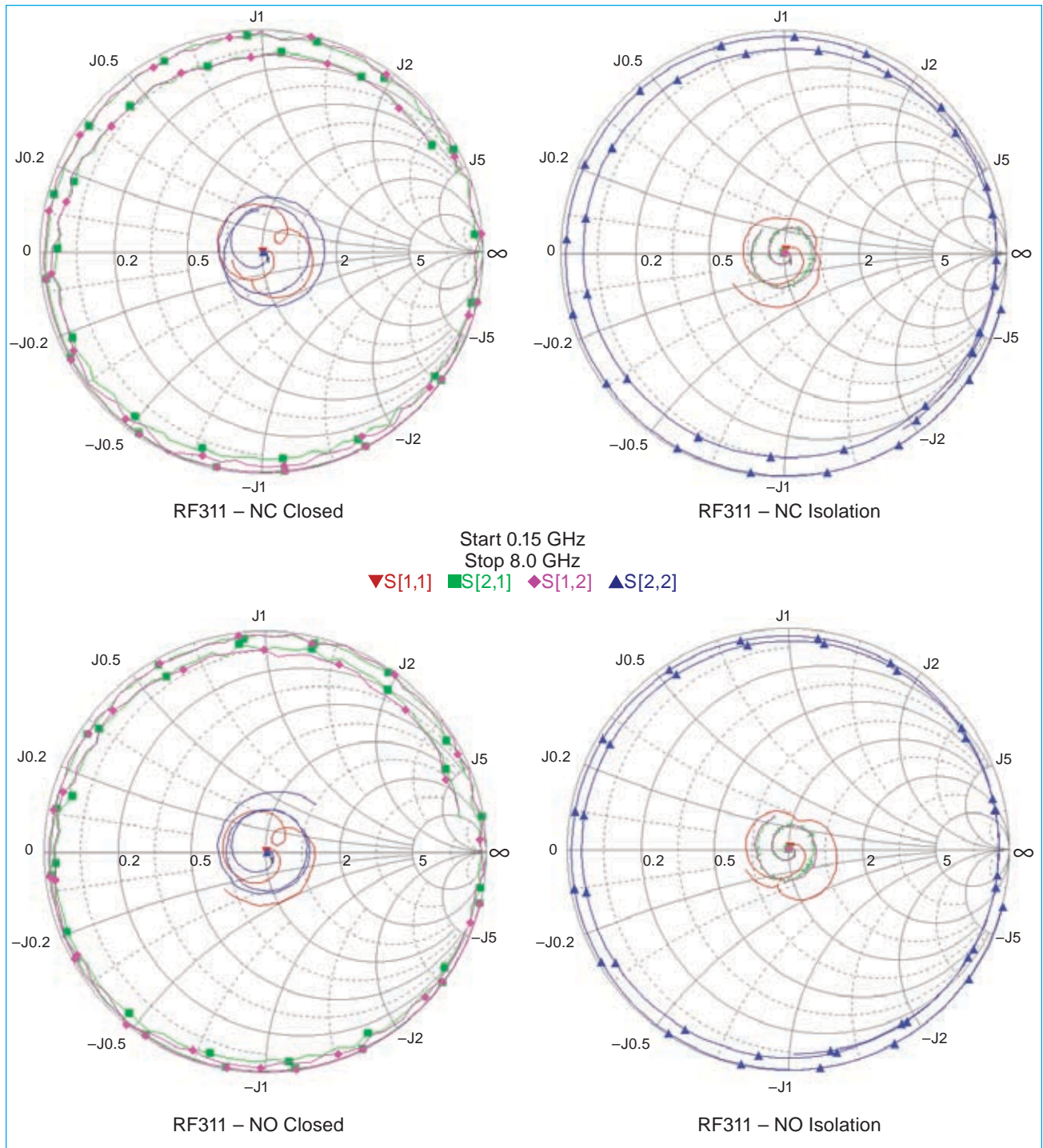

**RF NOTES**

Relay part number[s]: RF311-5, lot 06377E0830  
 Frequency range: 0.15 GHz to 8.0 GHz [1]  
 Test signal level: -10 dBm  
 Test apparatus: Vector Network Analyzer HP8722D  
 Test temperature: Room ambient

Number of samples: 2 (except Smith Charts is 1 sample only)  
 Number of test points: 201  
 Data includes effect of test fixture: No  
 Mounting: Relays through hole mounted to RF PCB. Relay in contact with, but not soldered to, Ground. [Note 1]

NOTES: [a] RF PCB: 0.0031" copper clad, reinforced PTFE, RT/duroid® 5880 with SMA connectors (RT/duroid® is registered trademark of Rogers Corporation)

[b] During test, untested port is terminated with 50 Ω terminator

[c] Data herein are typical values based on the samples tested. Not for use as specification requirements.

## X-ON Electronics

Largest Supplier of Electrical and Electronic Components

*Click to view similar products for [teledyne manufacturer](#):*

Other Similar products are found below :

[CR-33S6E-TMS](#) [CR-38S33C-T](#) [611-13](#) [M28776/3-036L](#) [712DM2-12](#) [732DM-12](#) [EUM099-M265](#) [EUM139-M265](#) [FB512FSZ](#)  
[MOSD5050R200L](#) [MOSFD5050R200L](#) [MOSFD5050R50H](#) [MOSFD5050R50L](#) [PK007-003](#) [PK007-019](#) [PK007-024](#) [PK007-026](#) [PK116-2](#)  
[PK116-3](#) [PK1-5MM-102](#) [PK1-5MM-105](#) [PK1-5MM-120](#) [PK400-1](#) [PK702](#) [PKIT3-5MM-101](#) [PK-ZS-003](#) [PK-ZS-006](#) [PK-ZS-008](#) [PK-ZS-](#)  
[012](#) [PK-ZS-015](#) [PK-ZS-021](#) [PK-ZS-022](#) [PK-ZS-024](#) [GEN500-16B-60](#) [DRDT600240A10](#) [MS-250](#) [E3PT48A12](#) [E3PT48A50H](#) [EFD113R-](#)  
[D70](#) [EFM099R-M79](#) [EFM119-M160](#) [EFM411-M359\\*](#) [EFM759-M166\\*](#) [EFMT524-M159](#) [EFMT723-M159](#) [EFR1200480A150](#)  
[EFRD1200480R150](#) [EFRTP600240R150](#) [EISC82-TD](#) [MSO-DLS-18](#)