

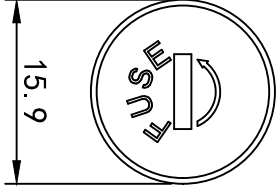

FH1

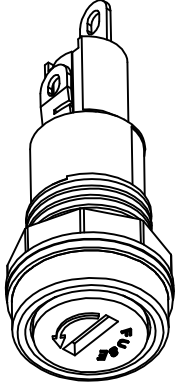
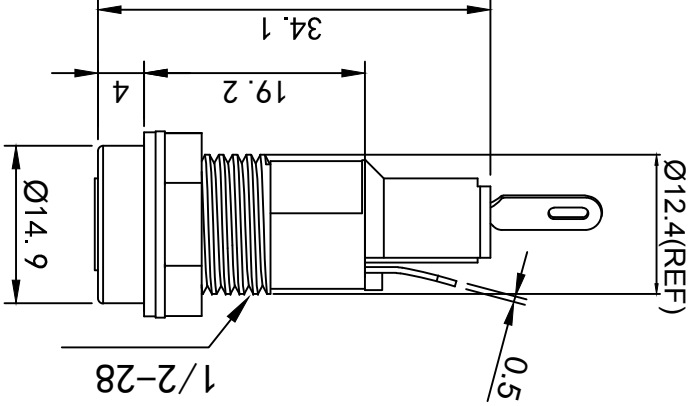
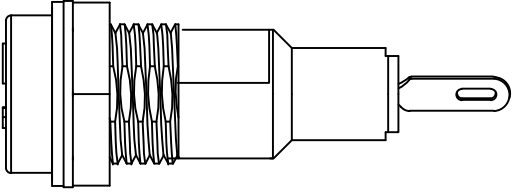

MATERIAL:

Housing:PT, UL rated 94V0 min
 Bayonet:PT, UL rated 94V0 min
 Terminal:Brass,silver or tin plated
 Nut:PT, UL rated 94V0 min

Fuse holder for overload protection

Screw-in mounting

Rating: 10A 250VAC (UL,CUL)

Fuse:Ø5.0x20mm

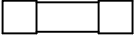

Cap:Bayonet type

Panel thickness:4.5mm max

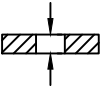

Operating Temperature:-10°C~+70°C



E240653

PANEL MOUNTING
 $\varnothing 12.5 \pm 0.1$

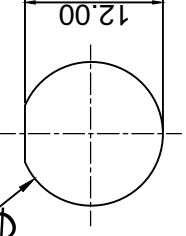

版本 VER	变更说明 CHANGE DESCRIPTION	日期 DATE	ECN NO	核准 APPROVED BY	陈宗胜	CHECKED BY 核对	杜沛钧	DRAWN BY 绘图	黎夏	FH1-B-PZ	FH1-B-PZ_A2
A0	New Issue	2009.02.26	N/A	核准		核对		绘图			
A1	重新整理发行	2014.07.26	N/A	VERSION	A2	SCALE 比例尺	1:1	DATE 日期	2018.03.01	品名 TITLE	DRAWING NO 图号
A2	重新整理发行	2018.03.01	N/A	版本		公差 TOLERANCES	.X±0.3, .XX±0.15	角度 ANGLE	±1°	单位 DIMENSION UNIT	mm.

X-ON Electronics

Largest Supplier of Electrical and Electronic Components

Click to view similar products for [Fuse Holder](#) category:

Click to view products by [HONGJU](#) manufacturer:

Other Similar products are found below :

[570-290-741P40](#) [570-290-751P40](#) [0031.1351.01](#) [020417G](#) [020418E](#) [80910030](#) [8601.2020](#) [9-3557-GP REV A](#) [15600-08-10](#) [BK1-HTC-45M](#)
[BK/FHN19G](#) [BK/HJM-HH](#) [BK/HKP-CCHH](#) [BK/HKP-E-CC](#) [BK/HKP-E-HH](#) [BK/HKP-EH-HH](#) [BK/HKP-U-HH](#) [BK/HTJ-LES-FUSE](#)
[HMG-241](#) [2086-1](#) [2193](#) [RTMF-SC](#) [2602](#) [2650](#) [FHN31G1](#) [G4PB8](#) [2660](#) [2799](#) [CQ-209V](#) [345621A](#) [3794](#) [4202](#) [4408](#) [4413](#) [4423](#) [4482](#)
[4532](#) [4537](#) [TSD1404-12](#) [BK/FHN31G1](#) [BK/HKP-H-CC](#) [BK/HKP-JQ-BB](#) [BK/HKP-JQW-BB](#) [BK/HKP-N-HH](#) [BK/HKP-S-CC](#) [BK/HKP-W-](#)
[BBHH](#) [BP/HHS](#) [BPHHU](#) [55900008011](#) [C1933](#)