

PRELIMINARY SPECIFICATIONS



Customer Part No.: _____ HELE. Part No: **X3S024000B91H-DEPV**
Application For: _____ Products: **CRYSTAL**
Accepted Model: _____ Type & Freq.: **HSX321S / 24.000MHz**
Sample Order No: _____ Date: **2012/08/07**

Approved By :

加高電子股份有限公司
加高電子股份有限公司

HARMONY ELECTRONICS CORP.

HARMONY ELECTRONICS (THAILAND) CO., LTD.

HARMONY ELECTRONICS (SHENZHEN) CORP., LTD.

TAIPEI OFFICE:

公司:(114)
台北市內湖區堤頂大道 2 段 409 號 2 樓
2F., NO.409, SEC.2, TIDING BLVD.,
NEIHU DISTRICT, TAIPEI CITY 114,
TAIWAN (R.O.C.)
TEL:886-2-26588883
FAX:886-2-26588683

TAIWAN FACTORY:

工廠:(831)
高雄市大寮區大發工業區華東路 39 號
No.39, Hua dong Rd., Daliao Dist.,Dafa
Industrial Park., Kaohsiung City 831,
Taiwan (R.O.C.)
TEL: (07)787-1555-6
FAX: (07)787-1557

THAILAND FACTORY:

66MOO 5, KAONGU-BEOKPRAI RD.,
T.BEOKPRAI, A. BANPONG,
RAJCHABUREE PROVINCE 70110,
THAILAND
TEL: (032)221994-6, 200740-1
FAX: (032)200742

SHENZHEN FACTORY:

深圳市福永鎮塘尾村塘橋路聚源工業區
QIAO TANG RD., TANGWEI VILLAGE
FU YONG TOWN SHENZHEN CITY
CHINA
TEL: 0755-7309272 / 7309262
FAX: 0755-7309755

| | | | | | | |
|---|------------|------------|------------|---|------|------|
| Title HSX321S QUARTZ CRYSTAL SPECIFICATION | | | | Country of origin TAIWAN FACTORY THAILAND FACTORY SHENZHEN FACTORY | | |
| Date | Confirm | Check | Prepare | Spec. No. | Rev. | Page |
| 2012/08/07 | F. S. TSAI | C. L. WANG | U. F. CHEN | X3S024000B91H-DEPV | 0 | 1 |

HARMONY ELECTRONICS CORP.

HSX321S SPECIFICATION

INDEX

| ITEM | PAGE |
|--|-------|
| 1. QUARTZ CRYSTAL UNIT SPECIFICATION | 3 |
| 2. MARKING & DIMENSIONS | 4 |
| 3. INSIDE STRUCTURE | 5 |
| 4. EMBOSS CARRIER TAPE&REEL | |
| a. DIMENSIONS OF CARRIER TAPE | 6 |
| b. DIMENSIONS OF REEL | 6-7 |
| c. STORAGE CONDITION | 7 |
| d. STANDARD PACKING QUANTITY | 7 |
| e. MATERIAL OF TAPE | 7 |
| f. LABEL CONTENTS | 7 |
| g. TAPING DIMENSION | 8 |
| h. JOINT OF TAPE | 8 |
| i. RELEASE STRENGTH OF COVER TAPE | 8 |
| j. PACKAGE | 9 |
| 5. MECHANICAL PERFORMANCE | 10 |
| 6. ENVIRONMENTAL PERFORMANCE | 10 |
| 7. SUPPLEMENT | 11-12 |
| 8. FLOW CHART | 13 |
| 9. Environmental Workload Chemical Substance Components List . | 14 |
| 10. TEST DATA | |

| | | | | | | |
|---|------------|------------|------------|---|------|------|
| Title HSX321S QUARTZ CRYSTAL SPECIFICATION | | | | Country of origin TAIWAN FACTORY THAILAND FACTORY SHENZHEN FACTORY | | |
| Date | Confirm | Check | Prepare | Spec. No. | Rev. | Page |
| 2012/08/07 | F. S. TSAI | C. L. WANG | U. F. CHEN | X3S024000B91H-DEPV | 0 | 2 |

1. QUARTZ CRYSTAL UNIT SPECIFICATION

- | | |
|--------------------------------|---|
| 1. Frequency: | 24.000000MHz |
| 2. Holder type : | HSX321S |
| 3. Frequency tolerance: | +/-10 ppm at 25deg.C +/-3deg.C |
| 4. Equivalent resistance: | 70 ohms Max. / SERIES |
| 5. Storage temperature range: | -40 deg.C To +70 deg.C |
| 6. Operable temperature range: | -10 deg.C To +60 deg.C |
| 7. Temperature drift: | +/-10ppm -10 deg.C To +60 deg.C |
| 8. Loading capacitance (CL) : | 9.0pF |
| 9. Drive level: | 100 uW (±10uW) at 30 ohms |
| 10. Shunt Capacitance: | 2.0 pF Max |
| 11. Insulation resistance : | More than 500M ohms at DC 100V |
| 12. Mode of oscillation: | Fundamental |
| 13. Circuit: | Measured in HP/E5100A,S&A 250B |
| 14. Shocking : | Dropping from 50 cm height 3 times on firm wood |
| Variation : | Frequency less than +/-5 ppm Resistance less than +/- 15 % or 2ohms max. |
| 15. Aging: | Less than +/-5 ppm / Year |
| 16. Holder | HSX321S Seam type |
| 17. Dimensions and marking | Refer to page.4 |
| 18. Emboss carrier tape & reel | Refer to page.6 and page.7 |
| 19. Note: | |

| | | | | | | |
|---|------------|------------|------------|---|------|------|
| Title HSX321S QUARTZ CRYSTAL SPECIFICATION | | | | Country of origin TAIWAN FACTORY THAILAND FACTORY SHENZHEN FACTORY | | |
| Date | Confirm | Check | Prepare | Spec. No. | Rev. | Page |
| 2012/08/07 | F. S. TSAI | C. L. WANG | U. F. CHEN | X3S024000B91H-DEPV | 0 | 3 |

2. HSX321S MARKING & DIMENSIONS

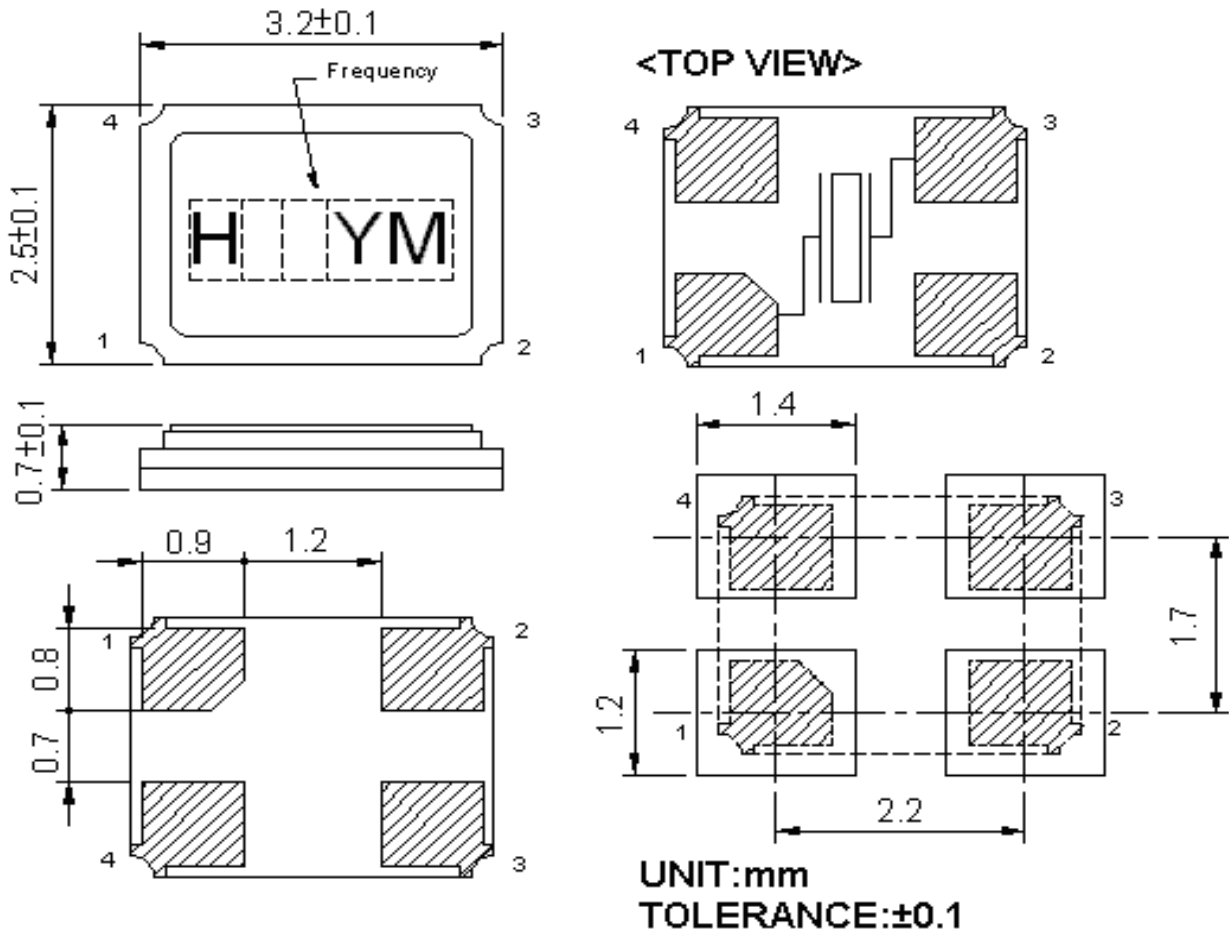

Chamfer index mark depends on the ceramic base supplier.

*Marking should be printed as following:

Logo, Nominal Frequency, Manufactured year & month

*Nominal frequency = integer only

(ex. 14.31818 MHz \rightarrow 14)

*Manufacturing Lot No.

(Y: year) ex. 2000 shall be marked as ' 0 ' (As shown on the Table-1)

(M: month) ex. June shall be marked as ' F ' (As shown on the Table-2).

Marking : Laser marking.

(Table-1)

| | | | | | | | | | | |
|------|------|------|------|------|------|------|------|------|------|------|
| Year | 2000 | 2001 | 2002 | 2003 | 2004 | 2005 | 2006 | 2007 | 2008 | 2009 |
| | 2010 | 2011 | 2012 | 2013 | 2014 | 2015 | 2016 | 2017 | 2018 | 2019 |
| Code | 0 | 1 | 2 | 3 | 4 | 5 | 6 | 7 | 8 | 9 |

(Table-2)

| | | | | | | | | | | | |
|------|------|------|------|------|------|------|------|------|------|------|------|
| Jan. | Feb. | Mar. | Apr. | May. | Jun. | Jul. | Aug. | Sep. | Oct. | Nov. | Dec. |
| A | B | C | D | E | F | G | H | J | K | L | M |

Title **HSX321S**
QUARTZ CRYSTAL SPECIFICATION

Country of origin **TAIWAN FACTORY**
THAILAND FACTORY
SHENZHEN FACTORY

| | | | | | | |
|------------|------------|------------|------------|---------------------------|------|------|
| Date | Confirm | Check | Prepare | Spec. No. | Rev. | Page |
| 2012/08/07 | F. S. TSAI | C. L. WANG | U. F. CHEN | X3S024000B91H-DEPV | 0 | 4 |

HARMONY ELECTRONICS CORP.

3. INSIDE STRUCTURE

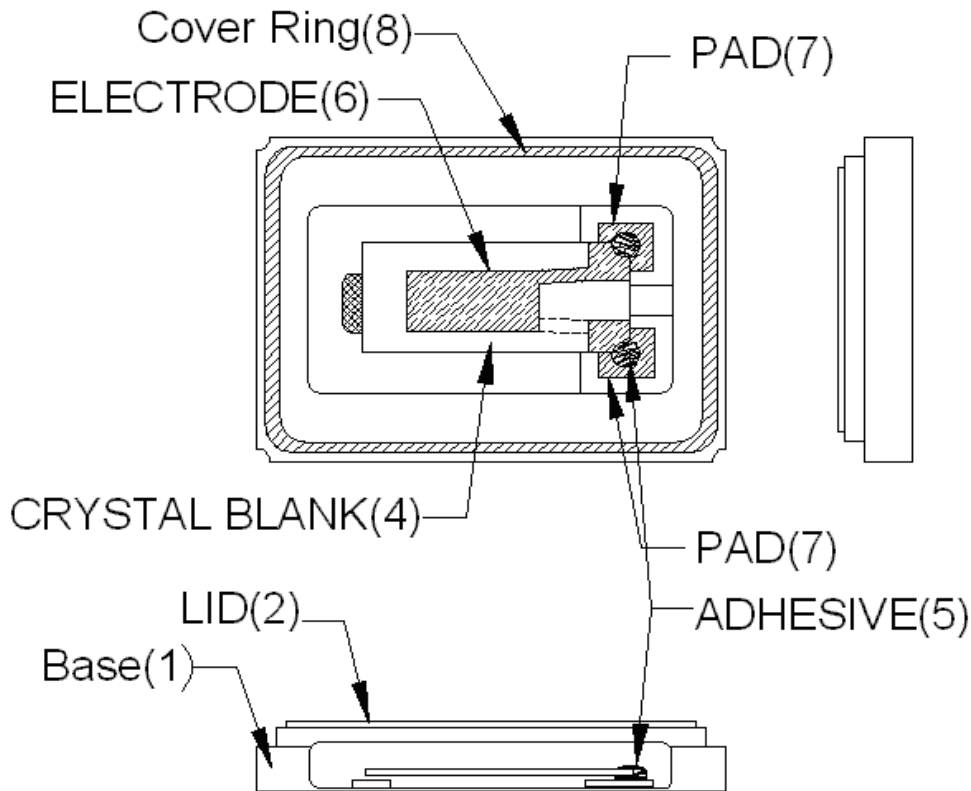

※Reference drawing

| |
|--|
| 1) Base: Alumina Ceramic (Al_2O_3) Metallized Pad: Ni Plating Au Plating |
| (2) Lid : Fe- Ni -Co |
| (3) Crystal Enclosure Seal: Seal Seam |
| (4) Crystal Blank Rectangular At-Cut Quartz Crystal Blank |
| (5) Adhesive Silver Conductive Silicon Resin Adhesive bonding: upper & lower bonding/lower bonding only |
| (6) Electrode |
| (7) PAD Alumina Ceramic (Ni. Au) |
| (8) Cover Ring : Fe-Ni-Co Alloy |

The use prohibition chemistry substance of Table 1 of DHE-0204-1 (HE-QA-24) is not included in this item.

| | | | | | | |
|---|------------|------------|------------|---|------|------|
| Title HSX321S QUARTZ CRYSTAL SPECIFICATION | | | | Country of origin TAIWAN FACTORY THAILAND FACTORY SHENZHEN FACTORY | | |
| Date | Confirm | Check | Prepare | Spec. No. | Rev. | Page |
| 2012/08/07 | F. S. TSAI | C. L. WANG | U. F. CHEN | X3S024000B91H-DEPV | 0 | 5 |

4. HSX321S EMOSS CARRIER TAPE & REEL

a.) Dimensions of Carrier Tape

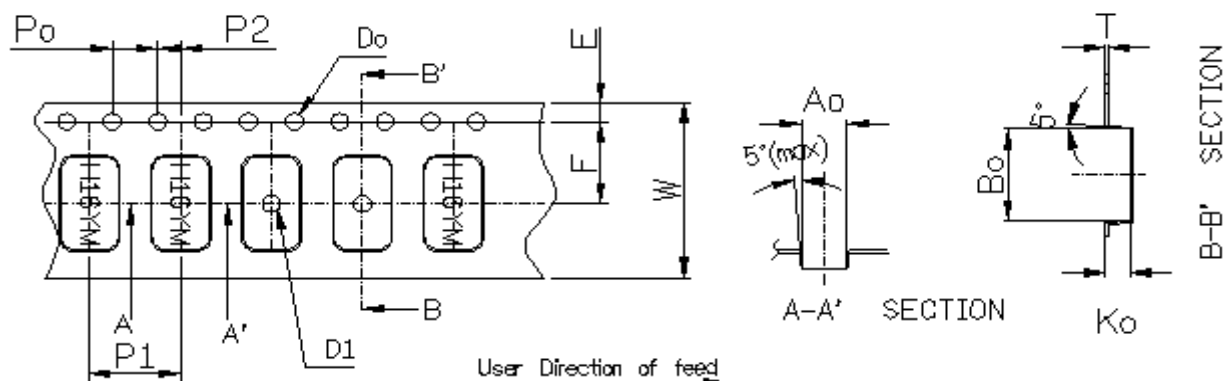

| | | | | | | |
|--------|----------------|----------------|----------------------|------------------|---------------|-----------------|
| Symbol | A_0 | B_0 | K_0 | P_0 | P_1 | P_2 |
| Spec | 2.70 ± 0.1 | 3.4 ± 0.1 | 1.40 ± 0.1 | 4.0 ± 0.1 | 4.0 ± 0.1 | 2.0 ± 0.05 |
| Symbol | E | F | D_0 | D_1 | W | T |
| Spec | 1.75 ± 0.1 | 3.5 ± 0.05 | $\phi 1.55 \pm 0.05$ | $\phi 1.0$ (min) | 8.0 ± 0.2 | 0.25 ± 0.05 |

b.) Dimensions of Reel

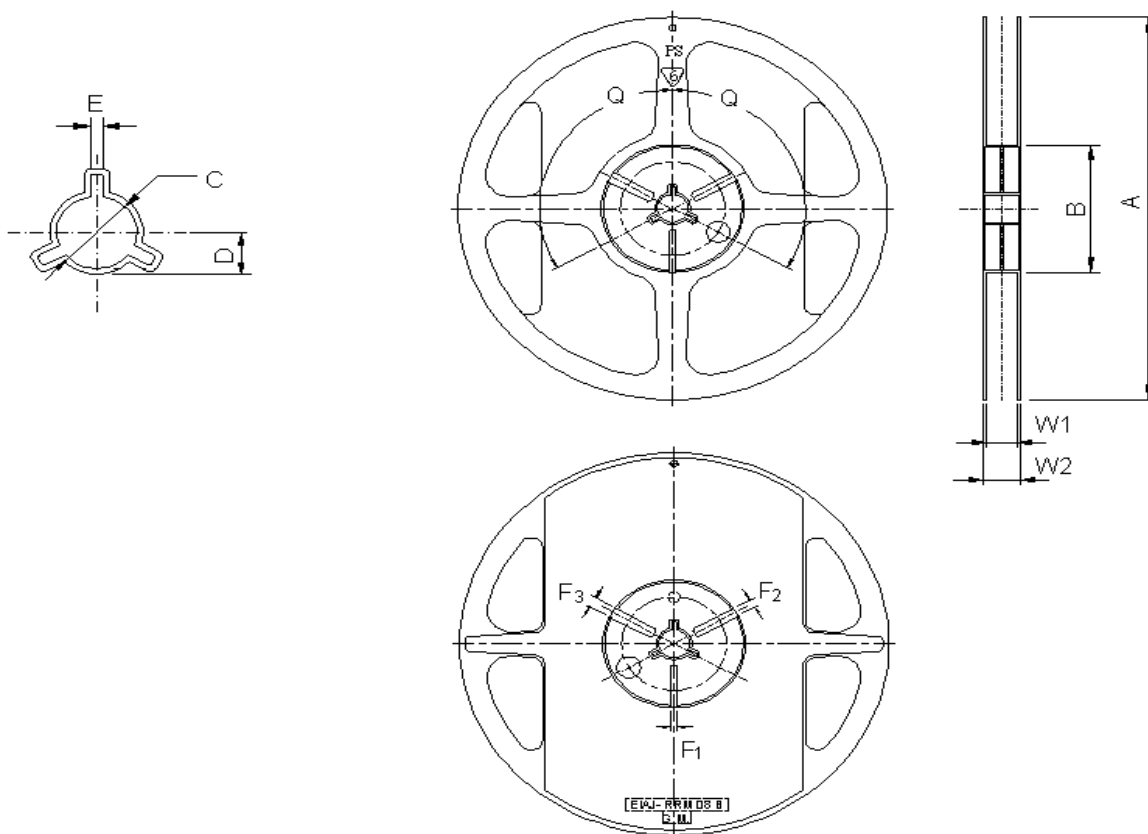

Title **HSX321S**
QUARTZ CRYSTAL SPECIFICATION

Country of origin **TAIWAN FACTORY**
THAILAND FACTORY
SHENZHEN FACTORY

| | | | | | | |
|------------|------------|------------|------------|---------------------------|------|------|
| Date | Confirm | Check | Prepare | Spec. No. | Rev. | Page |
| 2012/08/07 | F. S. TSAI | C. L. WANG | U. F. CHEN | X3S024000B91H-DEPV | 0 | 6 |

(Table-2)

(UNIT: mm)

| ITEM | | MARK | DIMENSIONS · ANGLE | |
|-----------|-------------------|----------|--------------------|-------------------|
| FLANCE | Diameter | A | ϕ 180+0/-3 | |
| | Inner Width | W1 | 9.3+/-0.3 | |
| | Outer Width | W2 | 11.3+/-1.0 | |
| HUB | Out Line diameter | B | ϕ 60.5+/-0.5 | |
| | Center Core slit | Width | F1 | 3.0+0.5/-0 |
| | | | F2 | 4.0+0.5/-0 |
| | | | F3 | 5.0+0.5/-0 |
| | | Position | q | 120deg |
| | Spindle diameter | | C | ϕ 13.2+/-0.5 |
| Key Ditch | Width | E | 3.0+/-0.2 | |

c.) Storage condition

Temperature: +40deg.C Max.

Relative Humidity: 80% Max.



d.) Standard packing quantity

3,000PCS / REEL

e.) Material of the tape

| Tape | Material |
|--------------|---------------|
| Carrier tape | PS Conductive |
| Top tape | Polyester |

f.) Label contents

| | |
|---|-----|
|  | |
| TYPE: | |
| SPEC.No.: | |
| Parts No.: | |
| LotNo.: | |
| FREQ.: | MHz |
| Q'TY: | PCS |
| HARMONY ELECTRONICS CORP.  HSF | |

Sticks label for every reel.

| | | | | | | |
|---|------------|------------|------------|---|------|------|
| Title HSX321S QUARTZ CRYSTAL SPECIFICATION | | | | Country of origin TAIWAN FACTORY THAILAND FACTORY SHENZHEN FACTORY | | |
| Date | Confirm | Check | Prepare | Spec. No. | Rev. | Page |
| 2012/08/07 | F. S. TSAI | C. L. WANG | U. F. CHEN | X3S024000B91H-DEPV | 0 | 7 |

HARMONY ELECTRONICS CORP.

g.) Taping dimension

| | | |
|----------|--------------|---|
| Leader | Cover-tape | The length of cover-tape in the leader is more than 400 mm including empty embossed area. |
| | Carrier-tape | After all products were packaged, must remain more than twenty pieces or 400 mm empty area, which should be sealed by cover-tape. |
| Terminal | Cover-tape | The tip of cover-tape shall be fixed temporary by paper tape and roll around the core of reel one round. |
| | Carrier-tape | The empty embossed area which are sealed by top cover-tape must remain more the 40 mm. |

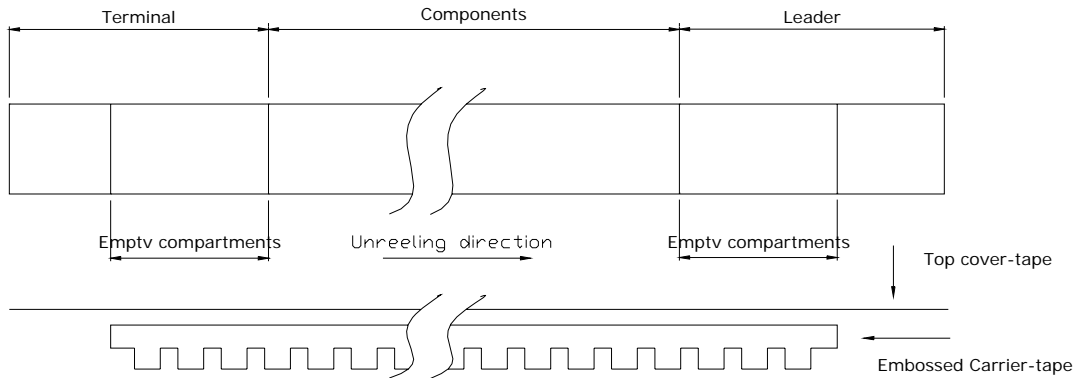

h.) Joint of tape

The carrier-tape and top cover-tape should not be jointed.

i.) Release strength of cover tape

It has to between 0.1N to 0.7N under following condition.

Pulling direction 165° to 180°

Speed 300mm/min.

Otherwise unless specified.

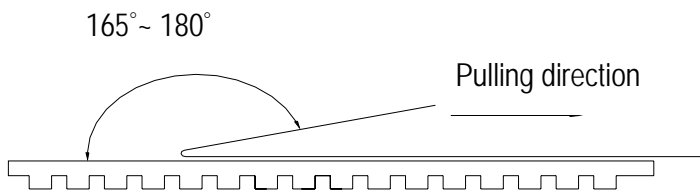

Other standards shall be based on JIS C 0806-1990.

| | | | | | | |
|---|------------|------------|------------|---|------|------|
| Title HSX321S QUARTZ CRYSTAL SPECIFICATION | | | | Country of origin TAIWAN FACTORY THAILAND FACTORY SHENZHEN FACTORY | | |
| Date | Confirm | Check | Prepare | Spec. No. | Rev. | Page |
| 2012/08/07 | F. S. TSAI | C. L. WANG | U. F. CHEN | X3S024000B91H-DEPV | 0 | 8 |

j.) Package

1. Reel : $\varnothing 180$

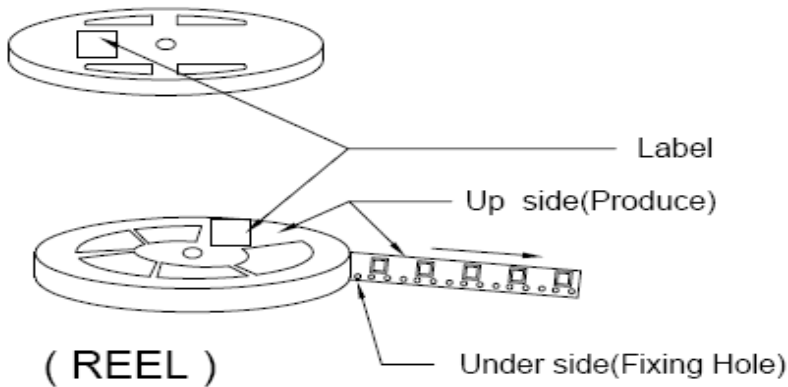

2. Carton One reel quantity:[1000pcs] & [3000pcs]

- ① Top and bottom with 2.3cm thickness foam-rubber cushion for protection.
- ② Carton's Q'TY: 1~15 pcs.
- ③ Carton Type=A,B,C use 4 trigon pillar to fasten the Reel.
- ④ Need to add 3 pages dry agent in each outer box.

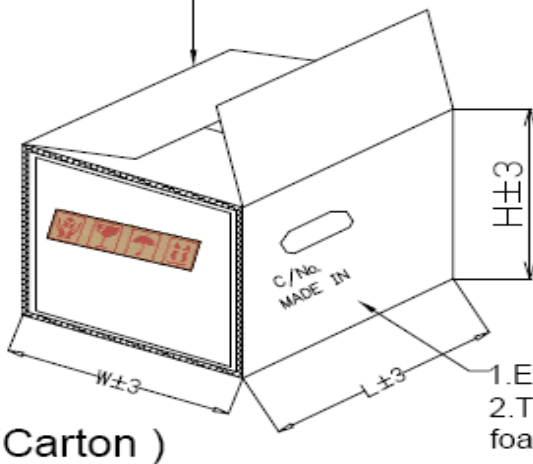
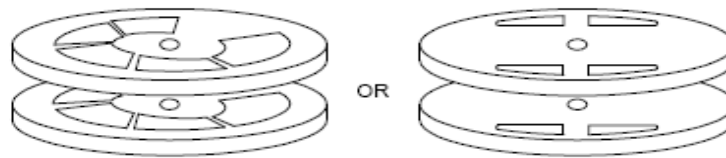

| Carton Type | A | B | C | D |
|--------------|---------|-----------------|--------|-------|
| Produce Type | 840/751 | 630/531/ 421 | 321/21 | OTHER |
| Reel | 15 | 15 | 15 | 1~7 |
| L±3 | 200 | 200 | 200 | 195 |
| W±3 | 200 | 200 | 200 | 195 |
| H±3 | 230 | 230 | 230 | 150 |

1. Every Carton with 3 desiccant.
2. Top and bottom with 2.3cm thickness foam-rubber cushion for protection

(Carton)

| | | | | | | |
|---|------------|------------|------------|---|------|------|
| Title HSX321S QUARTZ CRYSTAL SPECIFICATION | | | | Country of origin TAIWAN FACTORY THAILAND FACTORY SHENZHEN FACTORY | | |
| Date | Confirm | Check | Prepare | Spec. No. | Rev. | Page |
| 2012/08/07 | F. S. TSAI | C. L. WANG | U. F. CHEN | X3S024000B91H-DEPV | 0 | 9 |

5. Mechanical Performance

| Item | | Test Methods | Specifications Code |
|------|-------------------|---|---------------------|
| 1 | Natural Drop | Drop 3 times from the height of 50cm onto min. 30mm thickness hard wooden board. | A |
| 2 | Vibration | Frequency 10-55Hz, Sine Wave full amplitude of 0.8mm to X, Y and Z 3 axes, Duration of 2 hours to each axis. | A |
| 3 | Sealing Tightness | Leak Rate 1.0×10^{-8} Pa-m ³ /sec. Max. Measured by Helium leak detector. – Fine Leakage. | --- |
| 4 | Solder ability | After applying ROSIN Flux, dipping in solder bath at 245deg.C +/- 5deg.C for 3 +/- 0.5 sec. | B |

6. Environment Performance

| Item | | Test Methods | Specifications Code |
|------|-----------------------------|---|---------------------|
| 1 | Humidity | Temperature 60°C +/- 2°C, RH 90~95%, Duration of 240 hours. Back to room temperature first, then in 1~2 hours, the component shall be checked. | A |
| 2 | Storage in Low Temperature | -40deg.C +/- 2deg.C, Duration of 240 hours. Back to the room temperature first, then in 1~2 hours, the component shall be checked. | A |
| 3 | Storage in High Temperature | +85deg.C +/- 2deg.C, Duration of 240 hours. Back to the room temperature first, then in 1~2 hours, the component shall be checked. | A |
| 4 | Temperature cycles | -40deg.C +/- 2deg.C (30min) ↔ +85deg.C +/- 2deg.C (30min) 25 cycles. Back to the room temperature first, then in 1~2 hours, the component shall be checked. | A |

| Specifications code | Specifications |
|---------------------|---|
| A | Frequency variation shall be within +/- 5ppm and equivalent resistance shall be within the specification after the test |
| B | More than 90% of lead shall be covered by new solder. |
| | |

| | | | | | | |
|---|------------|------------|------------|---|------|------|
| Title HSX321S QUARTZ CRYSTAL SPECIFICATION | | | | Country of origin TAIWAN FACTORY THAILAND FACTORY SHENZHEN FACTORY | | |
| Date | Confirm | Check | Prepare | Spec. No. | Rev. | Page |
| 2012/08/07 | F. S. TSAI | C. L. WANG | U. F. CHEN | X3S024000B91H-DEPV | 0 | 10 |

7. Supplement

7.1.Soldering

7.2.Please stay with our proposed reflow condition and do then soldering 2 times max.

Available for Lead Free Soldering

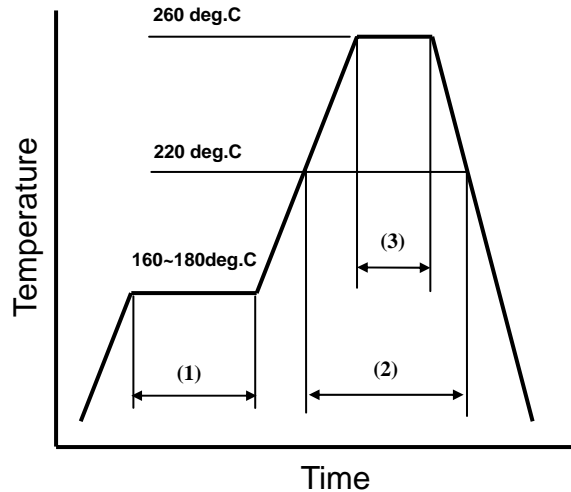

| | | | |
|-----|--------------|---------------|-------------|
| (1) | Preheat | 160~180 deg.C | 120sec. |
| (2) | Primary heat | 220 deg.C | 60sec. |
| (3) | Peak | 260 deg.C | 10sec. Max. |

7.3.Land pattern layout(Example)

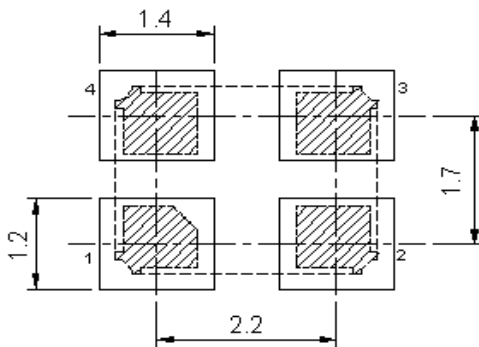

7.4.Solder iron (Example)

Bit temp.:350°C max.,Time:3sec max. ,Each terminal solder a 1 time max.

| | | | | | | |
|---|------------|------------|------------|---|------|------|
| Title HSX321S QUARTZ CRYSTAL SPECIFICATION | | | | Country of origin TAIWAN FACTORY THAILAND FACTORY SHENZHEN FACTORY | | |
| Date | Confirm | Check | Prepare | Spec. No. | Rev. | Page |
| 2012/08/07 | F. S. TSAI | C. L. WANG | U. F. CHEN | X3S024000B91H-DEPV | 0 | 11 |

HARMONY ELECTRONICS CORP.

7.5.Mounting

This component is designed for automatic insertion.

However, you are requested to do the trial with your insertion machine in order to be sure of proper operation and no damage of component.

Please pay attention to board warp which may damage the component and cause Soldering Process.

7.6.Cleaning

Cleaning liquid which corrodes Nickel shall not be used

It may cause the problem on the surface, color, marking etc.

Ultra-sonic cleaning is possible, however, you are requested to check on your board.

Because we only checked as single unit.

7.7.Storage

Please keep away from high temperature and high humidity ,which may cause put solderbility. No direct Sunlight, No dew as well.

| | | | | | | |
|---|------------|------------|------------|---|------|------|
| Title HSX321S QUARTZ CRYSTAL SPECIFICATION | | | | Country of origin TAIWAN FACTORY THAILAND FACTORY SHENZHEN FACTORY | | |
| Date | Confirm | Check | Prepare | Spec. No. | Rev. | Page |
| 2012/08/07 | F. S. TSAI | C. L. WANG | U. F. CHEN | X3S024000B91H-DEPV | 0 | 12 |

8. Flow Chart

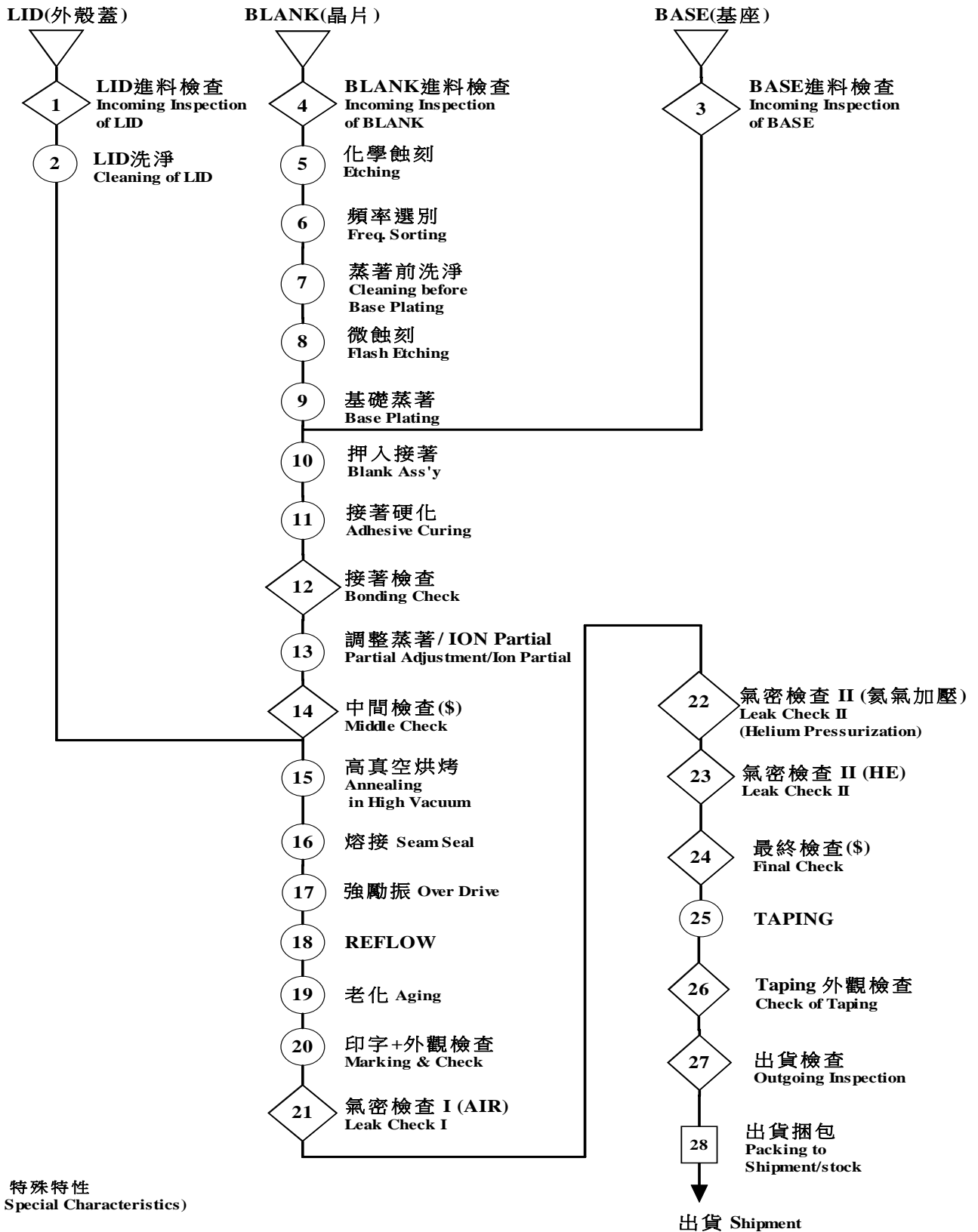

| | | | | | | |
|---|------------|------------|------------|---|------|------|
| Title HSX321S QUARTZ CRYSTAL SPECIFICATION | | | | Country of origin TAIWAN FACTORY THAILAND FACTORY SHENZHEN FACTORY | | |
| Date | Confirm | Check | Prepare | Spec. No. | Rev. | Page |
| 2012/08/07 | F. S. TSAI | C. L. WANG | U. F. CHEN | X3S024000B91H-DEPV | 0 | 13 |

9. Environmental Workload Chemical Substance Components List

| Environmental Workload Chemical Substance Components List | | |
|--|-------------------|---|
| Chemical Substance Components | TYPE | H(D)SX321S |
| | PERCENTAGE | |
| | | 20.5(mg) ppm |
| Si | | 0.04715 9.6658 |
| Au | | 0.15785 32.3593 |
| Co & Co Compound | | 1.21770 249.6285 |
| Mo & Mo Compound | | 0.04100 8.4050 |
| Ag | | 0.42640 87.4120 |
| Cu | | 0.11890 24.3745 |
| Cr & Cr Compound | | 0.04100 8.4050 |
| Al | | 5.09630 1044.7415 |
| Mn & Mn Compound | | 0.02460 5.0430 |
| W & W Compound | | 0.19885 40.7643 |
| Ni & Ni Compound | | 3.06680 628.6940 |
| Fe | | 4.14715 850.1658 |

| | | | | | | |
|---|-------------------|-------------------|-------------------|--|-------------|-------------|
| Title HSX321S QUARTZ CRYSTAL SPECIFICATION | | | | Country of origin TAIWAN FACTORY THAILAND FACTORY SHENZHEN FACTORY | | |
| Date | Confirm | Check | Prepare | Spec. No. | Rev. | Page |
| 2012/08/07 | F. S. TSAI | C. L. WANG | U. F. CHEN | X3S024000B91H-DEPV | 0 | 14 |

X-ON Electronics

Largest Supplier of Electrical and Electronic Components

Click to view similar products for [Crystals](#) category:

Click to view products by [Harmony](#) manufacturer:

Other Similar products are found below :

[CS325S24000000ABJT](#) [718-13.2-1](#) [MC405 32.0000K-R3:PURE SN](#) [FC-135R 32.7680KF-A3](#) [7A-40.000MAAE-T](#) [7B-27.000MBBK-T](#)
[FL2000085](#) [9B-15.360MBBK-B](#) [9C-7.680MBBK-T](#) [ASH7K-32.768KHZ](#) [AT-41.600MAGQ-T](#) [BTD1062E05A-513](#) [LFX TAL066198Cutt](#)
[9C-14.31818MBBK-T](#) [FA-238 50.0000MB30X-K3](#) [FC-12M 32.7680KA-AC3](#) [SSPT7F-9PF20-R](#) [FX325BS-38.88EEM1201](#)
[LFX TAL065253Cutt](#) [LFX TAL066431Cutt](#) [XT9S20ANA14M7456](#) [XT9SNLANA16M](#) [646G-24-2](#) [7A-24.576MBBK-T](#) [7B-30.000MBBK-T](#)
[WX26-32.768K-6PF](#) [9B-14.31818MBBK-B](#) [CD1AM](#) [7B-25.000MAAE-T](#) [7A-14.31818MBBK-T](#) [6504-202-1501](#) [6526-202-1501](#) [FA-118T](#)
[27.1200MB50P-K0](#) [FC-135R 32.7680KA-A3](#) [ABM12-104-37.400MHZT](#) [ABLS-10.000MHZ-D3W-T](#) [BTJ112E01E-513](#) [BTJ722K01C-7067](#)
[BTL-20-513](#) [TSX-3225 24.0000MF15X-AC](#) [TSX-3225 16.0000MF18X-AC](#) [BTJ120E02C](#) [BTL-12-513](#) [7A-10.000MBBK-T](#) [7A-](#)
[11.0592MBBK-T](#) [ABM12-103-24.000MHZT](#) [CS325S25000000ABJT](#) [ABM3B-25.000MHZ-B2-X-T](#) [FC-135 32.7680KA-A5](#) [FX0800015](#)