



# 2N7002

## 60V N-Channel Enhancement Mode MOSFET

### FEATURES

- $R_{DS(ON)}, V_{GS}@10V, I_{DS}@500mA=5\Omega$
- $R_{DS(ON)}, V_{GS}@4.5V, I_{DS}@75mA=7.5\Omega$
- Advanced Trench Process Technology
- High Density Cell Design For Ultra Low On-Resistance
- Specially Designed for Battery Operated Systems, Solid-State Relays Drivers : Relays, Displays, Lamps, Solenoids, Memories, etc.
- In compliance with EU RoHS 2002/95/EC directives

### MECHANICAL DATA

- Case: SOT-23 Package
- Terminals : Solderable per MIL-STD-750, Method 2026
- Marking : S72

SOT-23

Unit: inch ( mm )

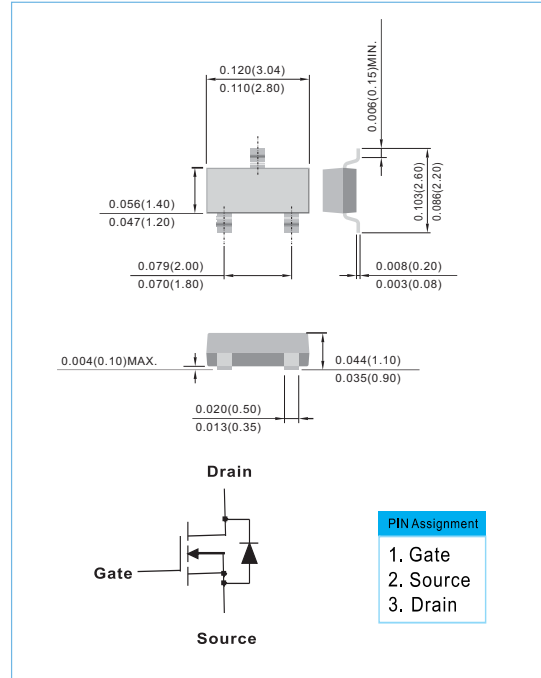

### Maximum Ratings and Thermal Characteristics ( $T_A=25^\circ\text{C}$ unless otherwise noted)

PARAMETER	Symbol	Limit	Units
Drain-Source Voltage	$V_{DS}$	60	V
Gate-Source Voltage	$V_{GS}$	$\pm 20$	V
Continuous Drain Current	$I_D$	250	mA
Pulsed Drain Current <sup>1)</sup>	$I_{DM}$	1300	mA
Maximum Power Dissipation	$P_D$	$T_A=25^\circ\text{C}$ 350 $T_A=75^\circ\text{C}$ 210	mW
Operating Junction and Storage Temperature Range	$T_J, T_{STG}$	-55 to + 150	$^\circ\text{C}$
Junction-to Ambient Thermal Resistance(PCB mounted) <sup>2)</sup>	$R_{\theta JA}$	357	$^\circ\text{C}/\text{W}$

- Note: 1. Maximum DC current limited by the package  
2. Surface mounted on FR4 board,  $t < 10$  sec

**PAN JIT RESERVES THE RIGHT TO IMPROVE PRODUCT DESIGN,FUNCTIONS AND RELIABILITY WITHOUT NOTICE**



# 2N7002

## ELECTRICAL CHARACTERISTICS

Parameter	Symbol	Test Condition	Min.	Typ.	Max.	Units
<b>Static</b>						
Drain-Source Breakdown Voltage	$BV_{DSS}$	$V_{GS}=0V, I_D=10\mu A$	60	-	-	V
Gate Threshold Voltage	$V_{GS(th)}$	$V_{DS}=V_{GS}, I_D=250\mu A$	1	-	2.5	V
Drain-Source On-State Resistance	$R_{DS(on)}$	$V_{GS}=4.5V, I_D=75mA$	-	-	7.5	Ω
Drain-Source On-State Resistance	$R_{DS(on)}$	$V_{GS}=10V, I_D=500mA$	-	-	5	
Zero Gate Voltage Drain Current	$I_{DSS}$	$V_{DS}=60V, V_{GS}=0V$	-	-	1	μA
Gate Body Leakage	$I_{GSS}$	$V_{GS}=\pm 20V, V_{DS}=0V$	-	-	±100	nA
Forward Transconductance	$g_{fs}$	$V_{DS}=15V, I_D=250mA$	200	-	-	mS
<b>Dynamic</b>						
Total Gate Charge	$Q_g$	$V_{DS}=15V, I_D=500mA$ $V_{DD}=4.5V$	-	0.6	0.7	nC
Gate-Source Charge	$Q_{gs}$		-	0.1	-	
Gate-Drain Charge	$Q_{gd}$		-	0.08	-	
Turn-On Time	$t_{on}$	$V_{DD}=10V, R_L=20\Omega$ $I_D=500mA, V_{GEN}=10V$ $R_G=10\Omega$	-	9	15	ns
Turn-Off Time	$t_{off}$		-	21	26	
Input Capacitance	$C_{iss}$	$V_{DS}=25V, V_{GS}=0V$ $f=1.0MHz$	-	-	50	pF
Output Capacitance	$C_{oss}$		-	-	25	
Reverse Transfer Capacitance	$C_{rss}$		-	-	5	
<b>Source-Drain Diode</b>						
Max. Diode Forward Current	$I_s$	-	-	-	250	mA
Diode Forward Voltage	$V_{SD}$	$I_s=250mA, V_{GS}=0V$	-	0.93	1.2	V

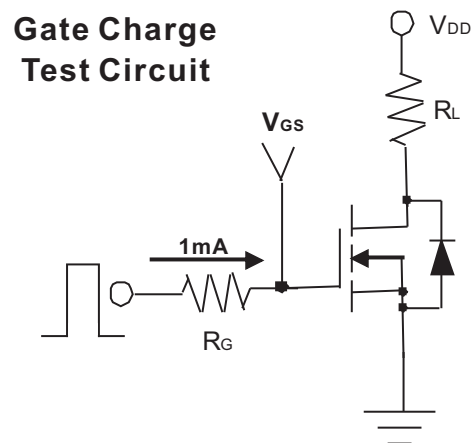
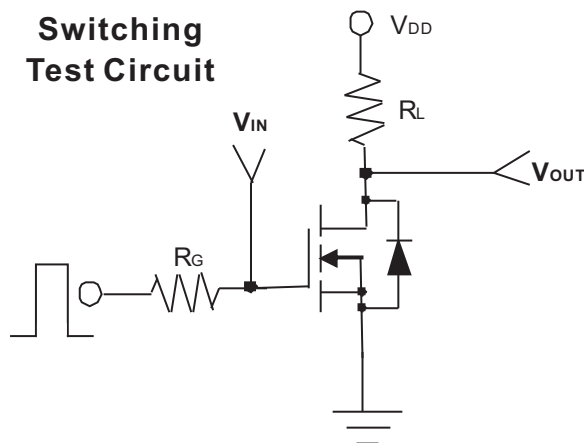



# 2N7002

Typical Characteristics Curves ( $T_A=25^\circ\text{C}$ , unless otherwise noted)

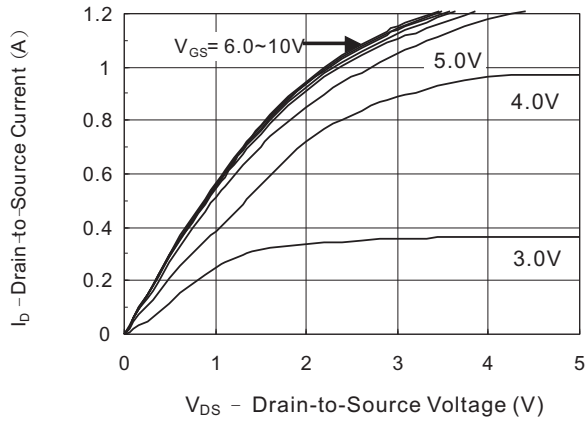

FIG.1- Output Characteristic

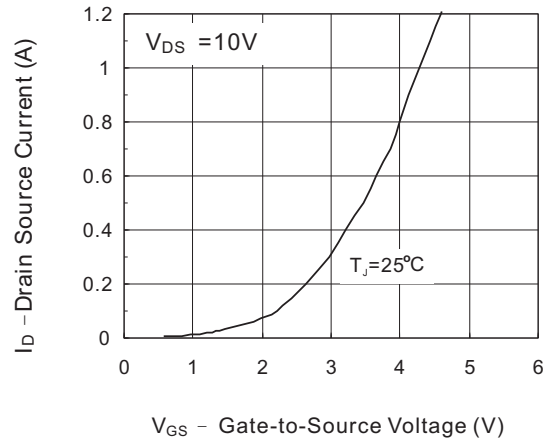

FIG.2- Transfer Characteristic

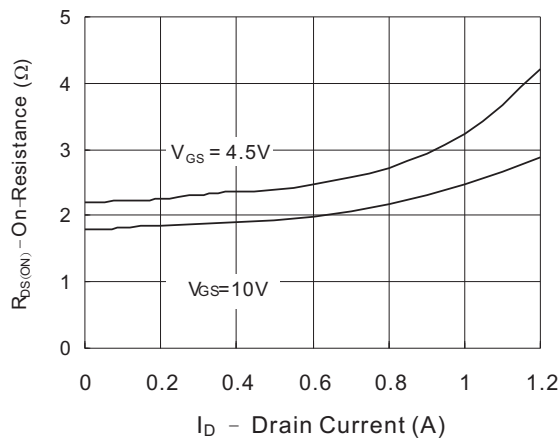

FIG.3- On Resistance vs Drain Current

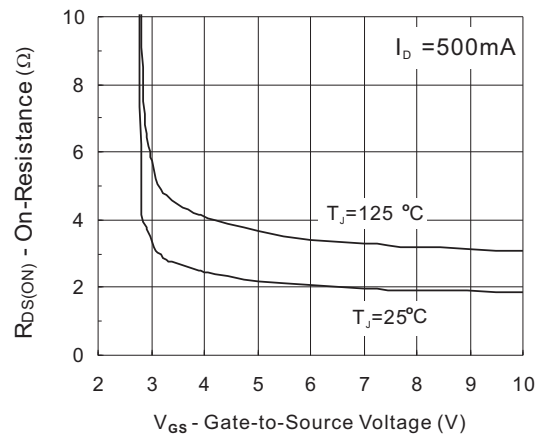

FIG.4- On Resistance vs Gate to Source Voltage

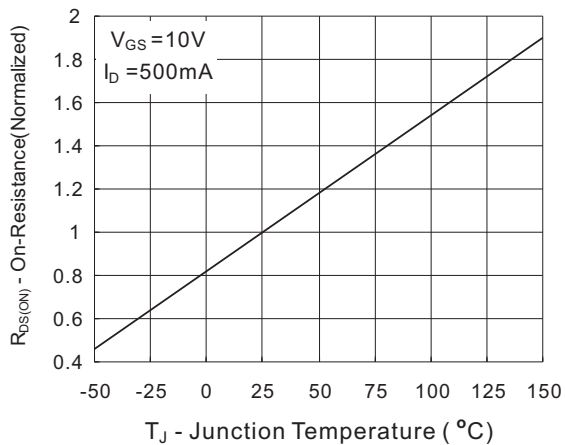

FIG.5- On Resistance vs Junction Temperature



# 2N7002

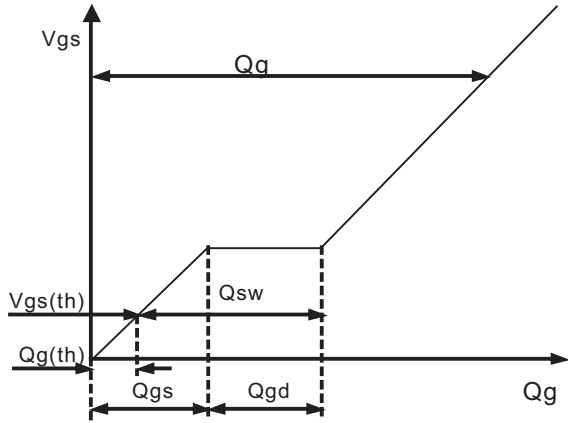

Fig.6 - Gate Charge Waveform

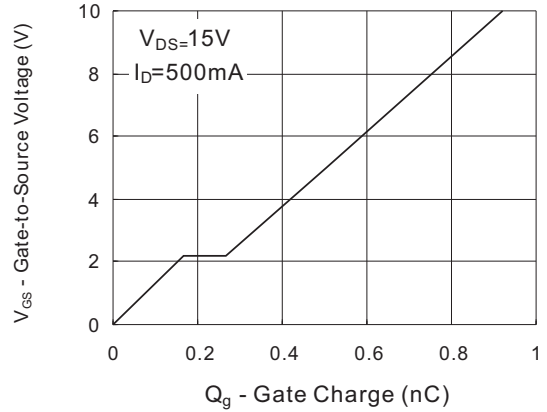

Fig.7 - Gate Charge

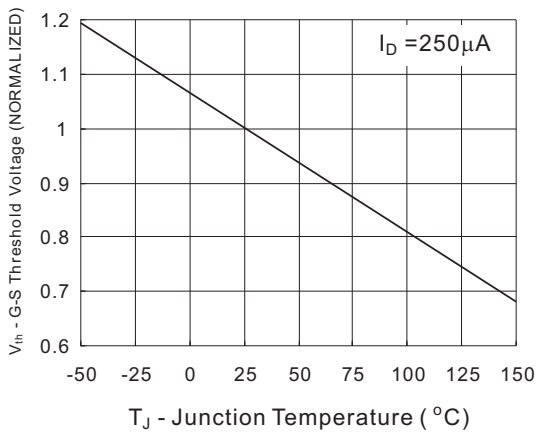

Fig.8 - Threshold Voltage vs Temperature

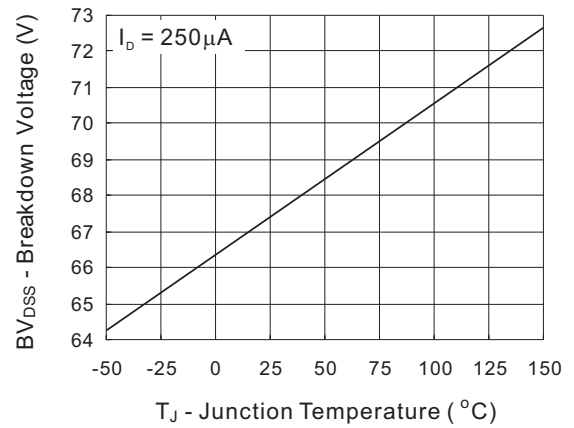

Fig.9 - Breakdown Voltage vs Junction Temperature

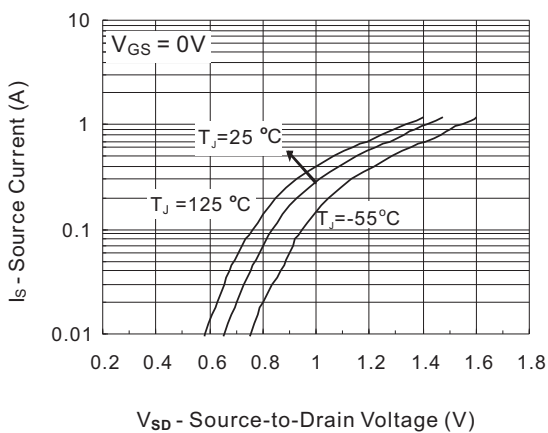

Fig.10 - Source-Drain Diode Forward Voltage

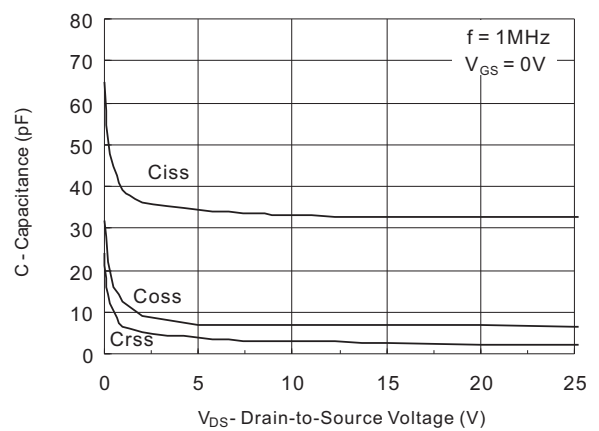
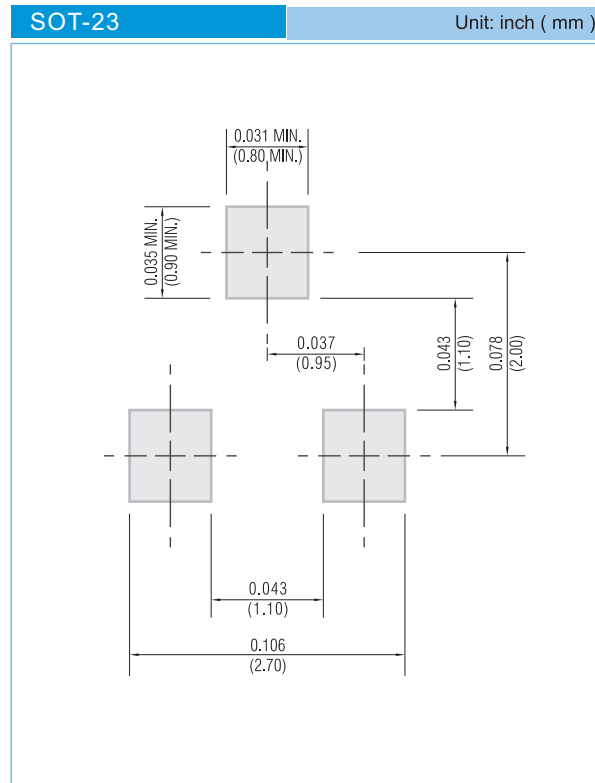

Fig.11 - Capacitance vs Drain to Source Voltage



# 2N7002

## MOUNTING PAD LAYOUT



### ORDER INFORMATION

- Packing information
  - T/R - 12K per 13" plastic Reel
  - T/R - 3K per 7" plastic Reel

### LEGAL STATEMENT

#### Copyright PanJit International, Inc 2011

The information presented in this document is believed to be accurate and reliable. The specifications and information herein are subject to change without notice. Pan Jit makes no warranty, representation or guarantee regarding the suitability of its products for any particular purpose. Pan Jit products are not authorized for use in life support devices or systems. Pan Jit does not convey any license under its patent rights or rights of others.

## X-ON Electronics

Largest Supplier of Electrical and Electronic Components

*Click to view similar products for [MOSFET](#) category:*

*Click to view products by [Panjit](#) manufacturer:*

Other Similar products are found below :

[614233C](#) [648584F](#) [MCH3443-TL-E](#) [MCH6422-TL-E](#) [FDPF9N50NZ](#) [FW231A-TL-E](#) [APT5010JVR](#) [NTNS3A92PZT5G](#) [IRF100S201](#)  
[JANTX2N5237](#) [2SK2464-TL-E](#) [2SK3818-DL-E](#) [FCA20N60\\_F109](#) [FDZ595PZ](#) [STD6600NT4G](#) [FSS804-TL-E](#) [2SJ277-DL-E](#) [2SK1691-DL-](#)  
[E](#) [2SK2545\(Q,T\)](#) [D2294UK](#) [405094E](#) [423220D](#) [MCH6646-TL-E](#) [TPCC8103,L1Q\(CM](#) [367-8430-0972-503](#) [VN1206L](#) [424134F](#) [026935X](#)  
[051075F](#) [SBVS138LT1G](#) [614234A](#) [715780A](#) [NTNS3166NZT5G](#) [751625C](#) [873612G](#) [IRF7380TRHR](#) [IPS70R2K0CEAKMA1](#)  
[RJK60S3DPP-E0#T2](#) [RJK60S5DPK-M0#T0](#) [APT5010JVFR](#) [APT12031JFLL](#) [APT12040JVR](#) [DMN3404LQ-7](#) [NTE6400](#) [JANTX2N6796U](#)  
[JANTX2N6784U](#) [JANTXV2N5416U4](#) [SQM110N05-06L-GE3](#) [SIHF35N60E-GE3](#) [2SK2614\(TE16L1,Q\)](#)