

LVS Series



LVS series, an automatic assembly constructed power inductor, is shielded with magnetic resin and suitable for the portable DC-DC converter applications.

Features

- RoHS compliant
- Highly accurate dimensions
- Terminals are highly resistant to external forces
- Highly reliable in environments of sudden temperature change and humidity
- Superior EMI characteristics with ultra low radiation comparing to conventional shielded power inductors

Applications

- LCD TV
- Monitor
- Ap router
- STB and smart phone
- Touch panel
- DSC
- Game console and other electronic devices

Product Identification

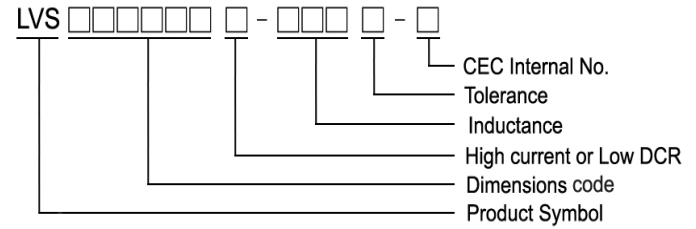
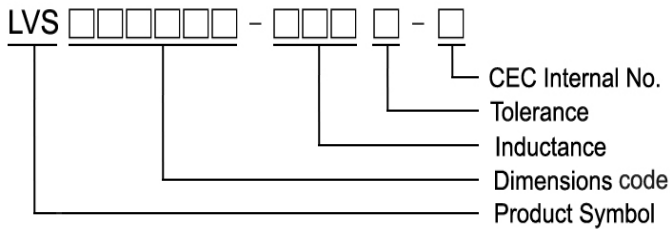

Shape and Dimensions

Figure 1

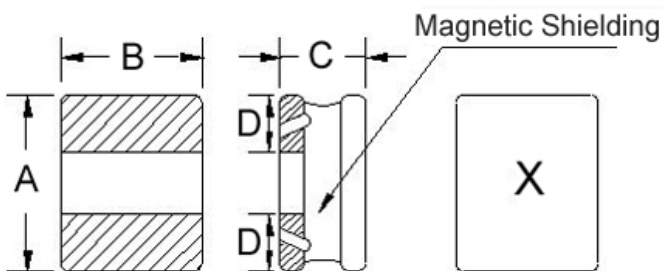

Recommended Pattern

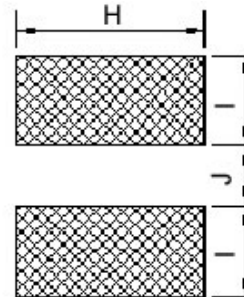

Dimensions in mm

TYPE	FIG	A	B	C Max	D	H	I	J
LVS201610	1	2.0±0.2	1.6±0.2	1.02	0.6	1.8	0.80	0.8
LVS252010	1	2.5±0.2	2.0±0.2	1.02	0.8	2.0	0.85	0.8
LVS252012	1	2.5±0.2	2.0±0.2	1.20	0.8	2.0	0.85	0.8

Shape and Dimensions

Figure 2

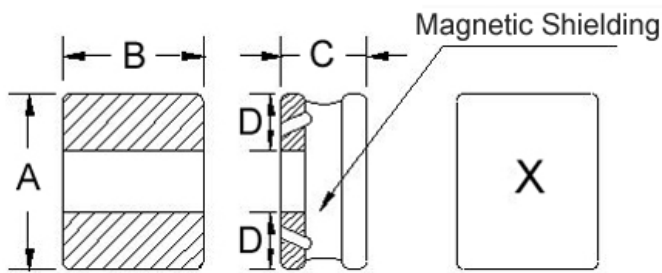
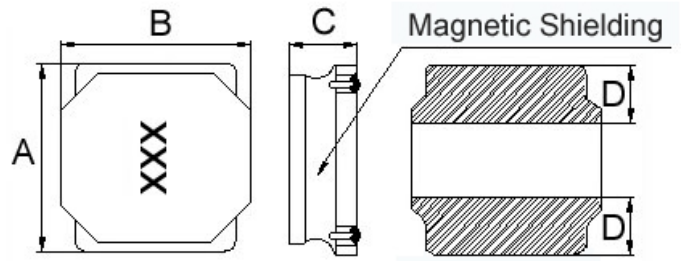

Figure 3



Dimensions in mm

TYPE	FIG	A	B	C	D	H	I	J
LVS303010	2	3.0±0.2	3.0±0.2	1.02Max.	1.0	3.0	1.0	1.0
LVS303010H	2	3.0±0.2	3.0±0.2	1.02Max.	1.0	3.0	1.0	1.0
LVS303012	2	3.0±0.2	3.0±0.2	1.20Max.	1.0	3.0	1.0	1.0
LVS303012H	2	3.0±0.2	3.0±0.2	1.20Max.	1.0	3.0	1.0	1.0
LVS303015	2	3.0±0.2	3.0±0.2	1.50Max.	1.0	3.0	1.0	1.0
LVS303015H	2	3.0±0.2	3.0±0.2	1.50Max.	1.0	3.0	1.0	1.0
LVS404012	2	4.0±0.2	4.0±0.2	1.20±0.1	1.5	4.2	1.5	1.2
LVS404018	3	4.0±0.2	4.0±0.2	1.8 ^{+0.2} _{-0.30}	1.3±0.3	3.7	1.2	1.6
LVS404026	3	4.0±0.2	4.0±0.2	2.6±0.2	1.4	3.7	1.2	1.6
LVS606028	3	6.0±0.2	6.0±0.2	2.8 ^{+0.2} _{-0.30}	1.9±0.3	5.7	1.6	2.9

Recommended Pattern

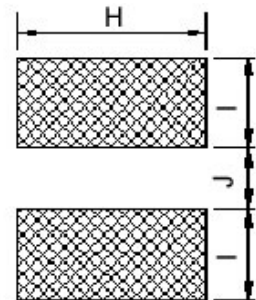

Shape and Dimensions

Figure 4

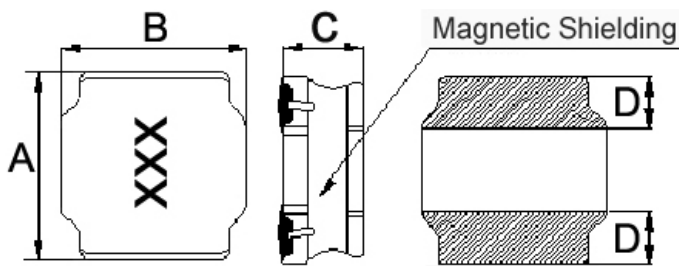
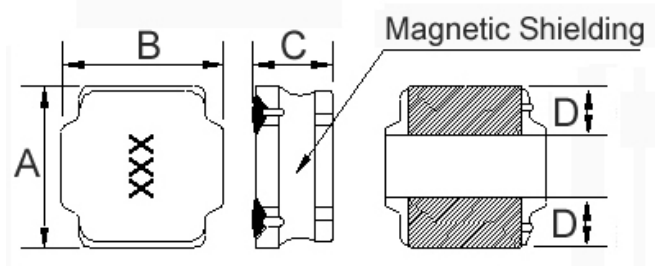

Figure 5



Dimensions in mm

TYPE	FIG	A	B	C	D	H	I	J
LVS505020	4	5.0±0.2	5.0±0.2	2.0 ^{+0.2} _{-0.30}	1.8±0.3	4.0	1.5	2.1
LVS505040	4	5.0±0.2	5.0±0.2	4.0 ^{+0.2} _{-0.30}	1.6±0.3	4.0	1.5	2.1
LVS606020	4	6.0±0.2	6.0±0.2	2.0 ^{+0.2} _{-0.30}	1.7±0.3	5.7	1.6	2.9
LVS606045	5	6.0±0.2	6.0±0.2	4.5 ^{+0.2} _{-0.30}	1.8±0.3	5.7	1.6	2.9
LVS606045L	5	6.0±0.2	6.0±0.2	4.5 ^{+0.2} _{-0.30}	1.8±0.3	5.7	1.6	2.9
LVS808040	5	8.0±0.2	8.0±0.2	4.0 ^{+0.2} _{-0.30}	2.3±0.3	7.5	2.1	3.8
LVS808040L	5	8.0±0.2	8.0±0.2	4.0 ^{+0.2} _{-0.30}	2.3±0.3	7.5	2.1	3.8

Recommended Pattern

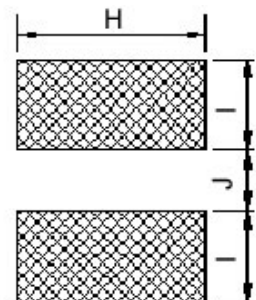

Electrical Characteristics

Part Number	Inductance (uH)	Test Frequency (MHz)	Tolerance (±%)	RDC (Ω ±30%)	Isat (mA) Typ. (Max)	Irms (mA) Typ. (Max)	Marking
LVS201610-1R0□-N	1.0	1	20, 30	0.17	1400(1260)	1600(1440)	A
LVS201610-1R5□-N	1.5	1	20, 30	0.26	1100(990)	1400(1260)	B
LVS201610-2R2□-N	2.2	1	20, 30	0.32	1000(900)	1200(1080)	C
LVS201610-3R3□-N	3.3	1	20, 30	0.51	820(738)	900(810)	D
LVS201610-4R7□-N	4.7	1	20, 30	0.67	680(612)	800(720)	E
LVS201610-5R6□-N	5.6	1	20, 30	0.72	650(585)	800(720)	F
LVS201610-6R8□-N	6.8	1	20, 30	0.97	560(504)	700(630)	G
LVS201610-100□-N	10	1	20, 30	1.45	470(423)	580(522)	H
LVS201610-120□-N	12	1	20, 30	1.65	420(378)	420(378)	J
LVS201610-220□-N	22	1	20, 30	2.90	310(279)	400(360)	I

- When ordering, please specify tolerance and packaging codes
- Tolerance : T = ±30% , M = ±20%
- L : Agilent/HP4287A+ Agilent/HP16197A, 1MHz 200mV
- RDC : Digital Milliohm Meter Chroma 16502, or equivalent
- Isat & I rms : Agilent/HP4284A, 1MHz 200mV
- Isat for Inductance drop 30% from its value without current
- I rms for a 40°C rise above 25°C ambient.
- Operating temperature range from -40°C to 125°C. (Including self - temperature rise)

Test Instruments : HP4284A Material/Impedance Analyzer

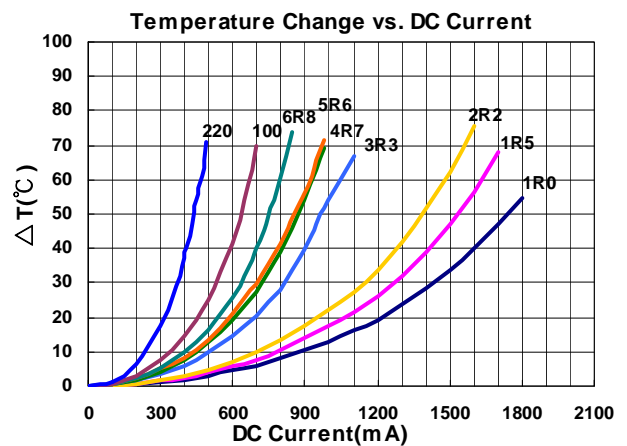
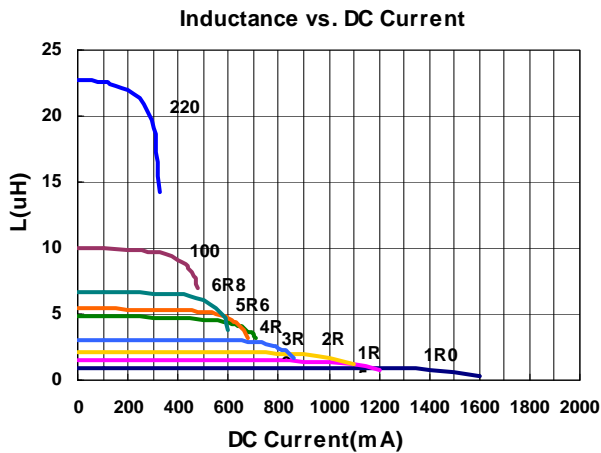

Electrical Characteristics

Part Number	Inductance (uH)	Test Frequency (MHz)	Tolerance (±%)	RDC (Ω) ±30%	Isat (mA) Typ. (Max)	Irms (mA) Typ. (Max)	Marking
LVS252010-1R0□-N	1.0	1	20, 30	0.093	2200(1980)	2200(1980)	A
LVS252010-1R5□-N	1.5	1	20, 30	0.148	1900(1710)	1800(1620)	B
LVS252010-2R2□-N	2.2	1	20, 30	0.178	1620(1458)	1680(1512)	C
LVS252010-3R3□-N	3.3	1	20, 30	0.286	1220(1098)	1340(1206)	D
LVS252010-4R7□-N	4.7	1	20, 30	0.421	1040(936)	1020(918)	E
LVS252010-5R6□-N	5.6	1	20, 30	0.481	920(828)	940(846)	F
LVS252010-6R8□-N	6.8	1	20, 30	0.598	900(810)	880(792)	G
LVS252010-100□-N	10	1	20, 30	0.797	740(666)	820(738)	H
LVS252010-150□-N	15	1	20, 30	1.450	520(468)	400(360)	L
LVS252010-220□-N	22	1	20, 30	1.839	500(450)	520(468)	I

- When ordering, please specify tolerance and packaging codes
- Tolerance : T = ±30% , M = ±20%
- Packaging: Clear tape and reel {standard}
- L : Agilent/HP4287A+ Agilent/HP16197A, 1MHz 200mV
- RDC : Digital Milliohm Meter Chroma 16502, or equivalent
- Isat & Irms : Agilent/HP4284A, 1MHz 200mV
- Isat for Inductance drop 30% from its value without current
- Irms for a 40°C rise above 25°C ambient.
- Operating temperature range from -40°C to 125°C. (Including self - temperature rise)

Test Instruments : HP4284A Material/Impedance Analyzer

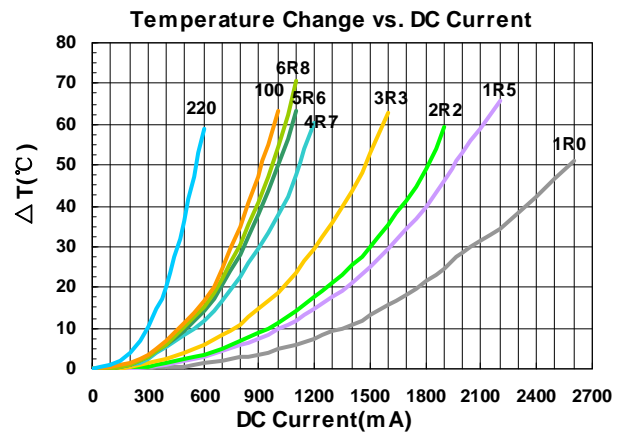
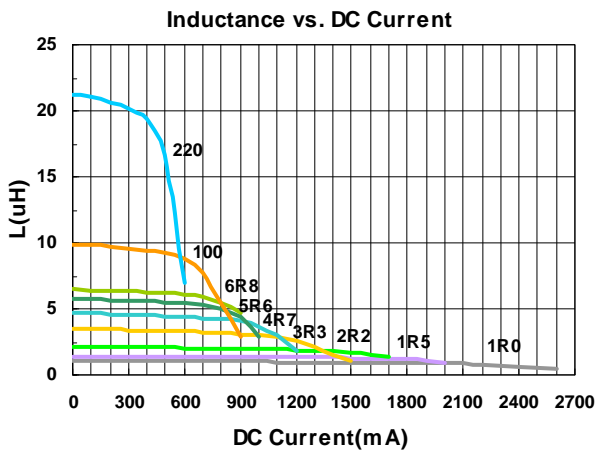

Electrical Characteristics

Part Number	Inductance (uH)	Test Frequency (MHz)	Tolerance (±%)	RDC (Ω) ±30%	Isat (mA) Typ. (Max)	Irms (mA) Typ. (Max)	Marking
LVS252012-1R0□-N	1.0	1	20, 30	0.105	2800(2520)	2200(1980)	A
LVS252012-1R5□-N	1.5	1	20, 30	0.153	2200(1980)	1860(1674)	B
LVS252012-2R2□-N	2.2	1	20, 30	0.219	1800(1620)	1700(1530)	C
LVS252012-3R3□-N	3.3	1	20, 30	0.349	1300(1170)	1200(1080)	D
LVS252012-4R7□-N	4.7	1	20, 30	0.507	1100(990)	1040(936)	E
LVS252012-5R6□-N	5.6	1	20, 30	0.525	1100(990)	1000(900)	F
LVS252012-6R8□-N	6.8	1	20, 30	0.760	940(846)	940(846)	G
LVS252012-100□-N	10	1	20, 30	0.915	820(738)	840(756)	H
LVS252012-220□-N	22	1	20, 30	2.110	550(495)	540(486)	I

- When ordering, please specify tolerance and packaging codes
- Tolerance : T = ±30% , M = ±20%
- L : Agilent/HP4287A+ Agilent/HP16197A, 1MHz 200mV
- RDC : Digital Milliohm Meter Chroma 16502, or equivalent
- Isat & I rms : Agilent/HP4284A, 1MHz 200mV
- Isat for Inductance drop 30% from its value without current
- I rms for a 40°C rise above 25°C ambient
- Operating temperature range from -40°C to 125°C . (Including self - temperature rise)

Test Instruments : HP4284A Material/Impedance Analyzer

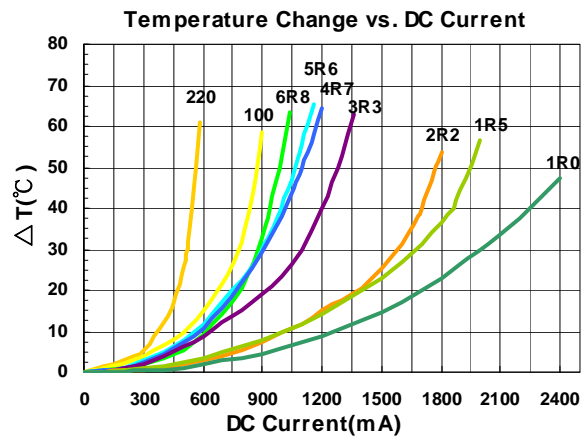
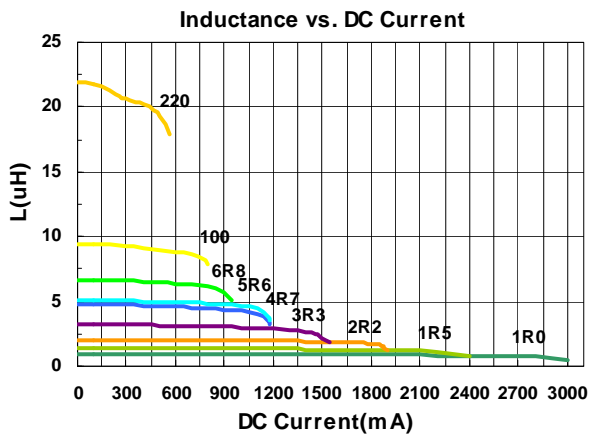

Electrical Characteristics

Part Number	Inductance (uH)	Test Frequency (MHz)	Tolerance (±%)	RDC (Ω) ±30%	Isat (mA) Typ. (Max)	Irms (mA) Typ. (Max)	Marking
LVS303010-1R0□-N	1.0	1	20, 30	0.063	1300(1170)	2400(2160)	1R0
LVS303010-1R5□-N	1.5	1	20, 30	0.077	1100(990)	2200(1980)	1R5
LVS303010-2R2□-N	2.2	1	20, 30	0.087	960(864)	2000(1800)	2R2
LVS303010-3R3□-N	3.3	1	20, 30	0.127	780(702)	1600(1440)	3R3
LVS303010-4R7□-N	4.7	1	20, 30	0.186	650(585)	1300(1170)	4R7
LVS303010-6R8□-N	6.8	1	20, 30	0.253	560(504)	1000(900)	6R8
LVS303010-100□-N	10	1	20, 30	0.353	430(387)	880(792)	100
LVS303010-220□-N	22	1	20, 30	0.693	310(279)	580(522)	220
LVS303010-470□-N	47	1	20, 30	1.800	210(189)	330(297)	470
LVS303010-221□-N	220	1	20, 30	6.500	82(73.8)	180(162)	221

- When ordering, please specify tolerance and packaging codes
- Tolerance : T = ±30% , M = ±20%
- L : Agilent/HP4287A+ Agilent/HP16197A, 1MHz 200mV
- RDC : Digital Milliohm Meter Chroma 16502, or equivalent
- Isat & I rms : Agilent/HP4284A, 1MHz 200mV
- Isat for Inductance drop 30% from its value without current
- I rms for a 40°C rise above 25°C ambient
- Operating temperature range from -40°C to 125°C. (Including self - temperature rise)

Test Instruments : HP4284A Material/Impedance Analyzer

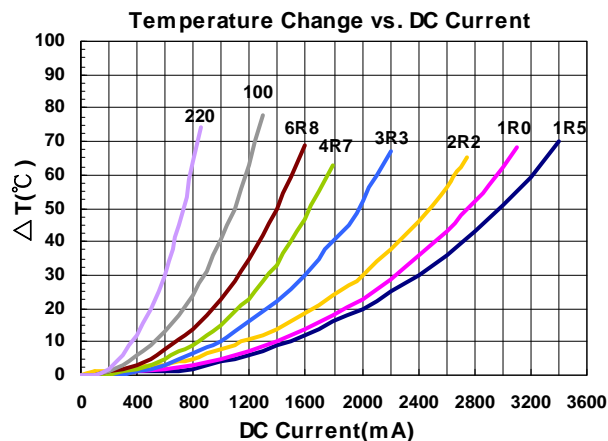
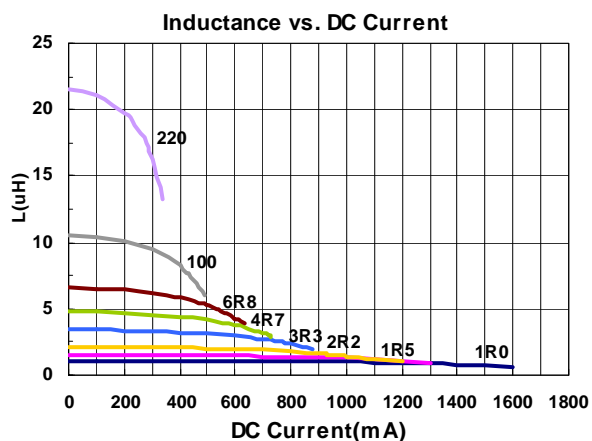

Electrical Characteristics

Part Number	Inductance (uH)	Test Frequency (MHz)	Tolerance (±%)	RDC (Ω) ±30%	Isat (mA) Typ. (Max)	Irms (mA) Typ. (Max)	Marking
LVS303010H-1R0□-N	1.0	1	20, 30	0.060	1800(1620)	2200(1980)	1R0
LVS303010H-1R5□-N	1.5	1	20, 30	0.075	1600(1440)	2100(1890)	1R5
LVS303010H-2R2□-N	2.2	1	20, 30	0.095	1400(1260)	1900(1710)	2R2
LVS303010H-3R3□-N	3.3	1	20, 30	0.140	1000(900)	1300(1170)	3R3
LVS303010H-4R7□-N	4.7	1	20, 30	0.190	850(765)	1200(1080)	4R7
LVS303010H-6R8□-N	6.8	1	20, 30	0.275	720(648)	1000(900)	6R8
LVS303010H-100□-N	10	1	20, 30	0.440	610(549)	860(774)	100
LVS303010H-220□-N	22	1	20, 30	0.800	420(378)	620(558)	220

- When ordering, please specify tolerance and packaging codes
- Tolerance : T = ±30% , M = ±20%
- L : Agilent/HP4287A+ Agilent/HP16197A, 1MHz 200mV
- RDC : Digital Milliohm Meter Chroma 16502, or equivalent
- Isat & I rms : Agilent/HP4284A, 1MHz 200mV
- Isat for Inductance drop 30% from its value without current
- I rms for a 40°C rise above 25°C ambient
- Operating temperature range from -40°C to 125°C. (Including self - temperature rise)

Test Instruments : HP4284A Material/Impedance Analyzer

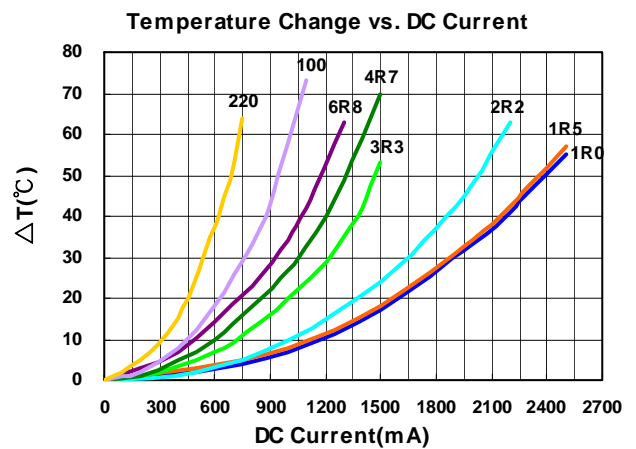
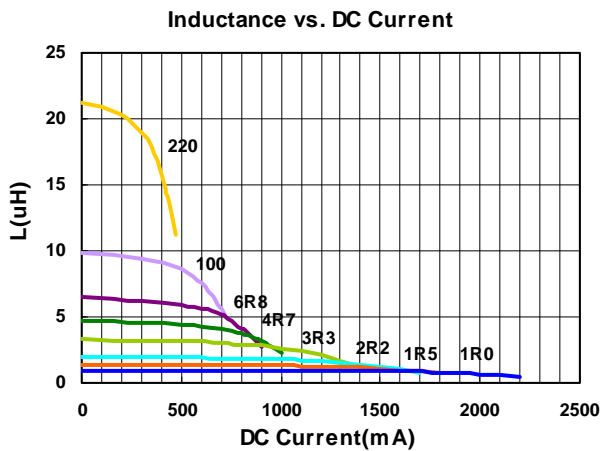

Electrical Characteristics

Part Number	Inductance (uH)	Test Frequency (MHz)	Tolerance (±%)	RDC (Ω) ±30%	Isat (mA) Typ. (Max)	Irms (mA) Typ. (Max)	Marking
LVS303012-1R0□-N	1.0	1	20, 30	0.048	1600(1440)	2500(2250)	1R0
LVS303012-1R5□-N	1.5	1	20, 30	0.063	1200(1080)	2300(2070)	1R5
LVS303012-2R2□-N	2.2	1	20, 30	0.076	1100(990)	2000(1800)	2R2
LVS303012-3R3□-N	3.3	1	20, 30	0.102	900(810)	1600(1440)	3R3
LVS303012-4R7□-N	4.7	1	20, 30	0.136	750(675)	1500(1350)	4R7
LVS303012-6R8□-N	6.8	1	20, 30	0.182	630(567)	1300(1170)	6R8
LVS303012-100□-N	10	1	20, 30	0.275	520(468)	1000(900)	100
LVS303012-220□-N	22	1	20, 30	0.594	350(315)	650(585)	220

- When ordering, please specify tolerance and packaging codes
- Tolerance : T = ±30% , M = ±20%
- L : Agilent/HP4287A+ Agilent/HP16197A, 1MHz 200mV
- RDC : Digital Milliohm Meter Chroma 16502, or equivalent
- Isat & Irms : Agilent/HP4284A, 1MHz 200mV
- Isat for Inductance drop 30% from its value without current
- Irms for a 40°C rise above 25°C ambient
- Operating temperature range from -40°C to 125°C. (Including self - temperature rise)

Test Instruments : HP4284A Material/Impedance Analyzer

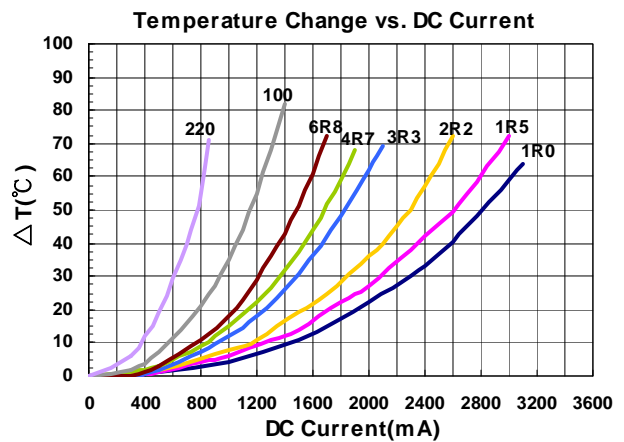
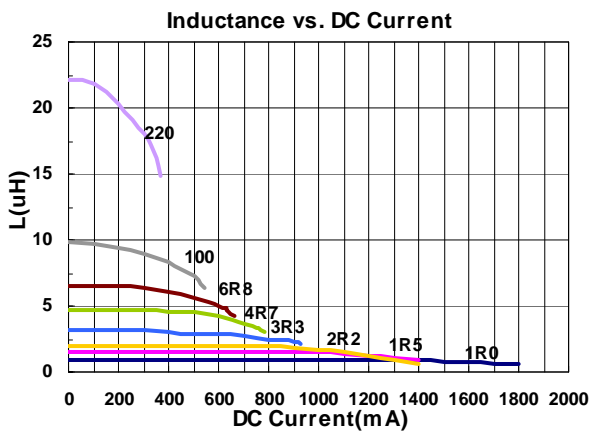

Electrical Characteristics

Part Number	Inductance (uH)	Test Frequency (MHz)	Tolerance (±%)	RDC (Ω) ±30%	Isat (mA) Typ. (Max)	Irms (mA) Typ. (Max)	Marking
LVS303012H-1R0□-N	1.0	1	20,30	0.056	1900(1710)	2100(1890)	1R0
LVS303012H-1R5□-N	1.5	1	20,30	0.065	1500(1350)	1850(1665)	1R5
LVS303012H-2R2□-N	2.2	1	20,30	0.080	1400(1260)	1800(1620)	2R2
LVS303012H-3R3□-N	3.3	1	20,30	0.100	1100(990)	1600(1440)	3R3
LVS303012H-4R7□-N	4.7	1	20,30	0.130	990(891)	1400(1260)	4R7
LVS303012H-6R8□-N	6.8	1	20,30	0.190	850(765)	1200(1080)	6R8
LVS303012H-100□-N	10	1	20,30	0.270	720(648)	1000(900)	100
LVS303012H-220□-N	22	1	20,30	0.600	450(405)	630(567)	220

- When ordering, please specify tolerance and packaging codes
- Tolerance : T = ±30% , M = ±20%
- L : Agilent/HP4287A+ Agilent/HP16197A, 1MHz 200mV
- RDC : Digital Milliohm Meter Chroma 16502, or equivalent
- Isat & Irms : Agilent/HP4284A, 1MHz 200mV
- Isat for Inductance drop 30% from its value without current
- Irms for a 40°C rise above 25°C ambient
- Operating temperature range from -40°C to 125°C. (Including self - temperature rise)

Test Instruments : HP4284A Material/Impedance Analyzer

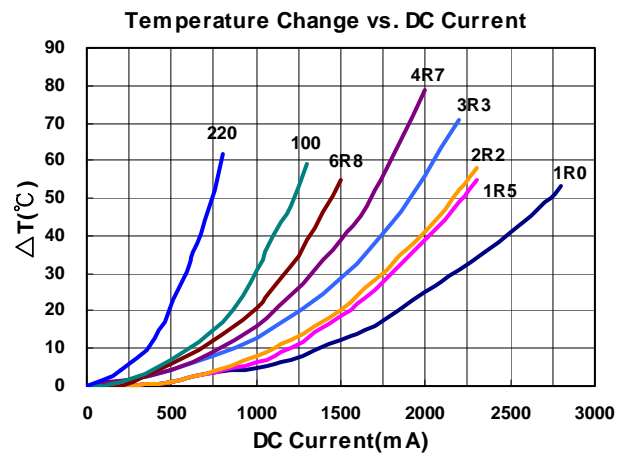
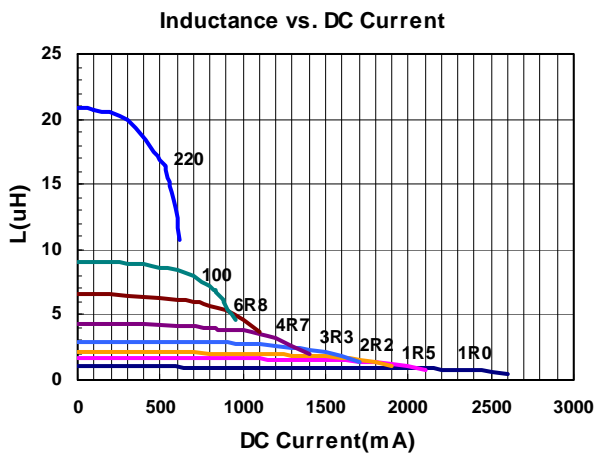

Electrical Characteristics

Part Number	Inductance (uH)	Test Frequency (MHz)	Tolerance (±%)	RDC (Ω) ±30%	Isat (mA) Typ. (Max)	Irms (mA) Typ. (Max)	Marking
LVS303015-1R0□-N	1.0	1	20, 30	0.056	2000(1800)	2800(2520)	1R0
LVS303015-1R5□-N	1.5	1	20, 30	0.074	1600(1440)	2400(2160)	1R5
LVS303015-2R2□-N	2.2	1	20, 30	0.079	1200(1080)	2300(2070)	2R2
LVS303015-3R3□-N	3.3	1	20, 30	0.105	1000(900)	1900(1710)	3R3
LVS303015-4R7□-N	4.7	1	20, 30	0.130	900(810)	1600(1440)	4R7
LVS303015-6R8□-N	6.8	1	20, 30	0.165	730(657)	1300(1170)	6R8
LVS303015-100□-N	10	1	20, 30	0.206	600(540)	1000(900)	100
LVS303015-220□-N	22	1	20, 30	0.501	420(378)	650(585)	220
LVS303015-330□-N	33	1	20, 30	0.600	330(297)	600(540)	330
LVS303015-820□-N	82	1	20, 30	1.600	210(189)	350(315)	820
LVS303015-101□-N	100	1	20, 30	1.800	200(180)	300(270)	101

- When ordering, please specify tolerance and packaging codes
- Tolerance : T = ±30% , M = ±20%
- L : Agilent/HP4287A+ Agilent/HP16197A, 1MHz 200mV
- RDC : Digital Milliohm Meter Chroma 16502, or equivalent
- Isat & I rms : Agilent/HP4284A, 1MHz 200mV
- Isat for Inductance drop 30% from its value without current
- I rms for a 40°C rise above 25°C ambient
- Operating temperature range from -40°C to 125°C. (Including self - temperature rise)

Test Instruments : HP4284A Material/Impedance Analyzer

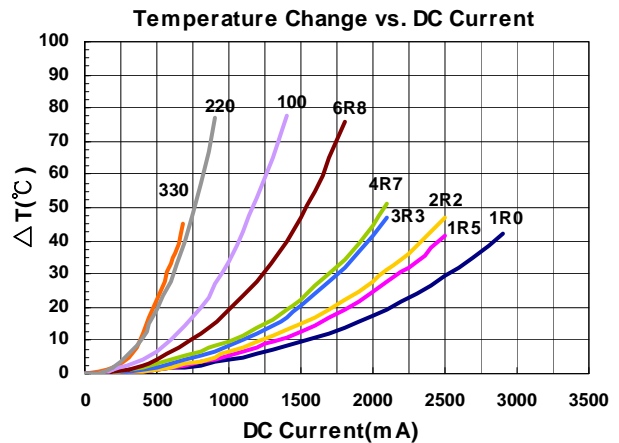
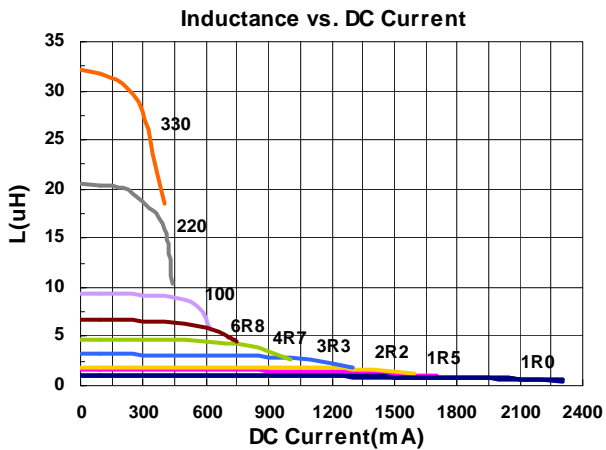

Electrical Characteristics

Part Number	Inductance (uH)	Test Frequency (MHz)	Tolerance (±%)	RDC (Ω ±30%)	Isat (mA) Typ. (Max)	Irms (mA) Typ. (Max)	Marking
LVS303015H-1R0□-N	1.0	1	20, 30	0.053	2000(1800)	2100(1890)	1R0
LVS303015H-1R5□-N	1.5	1	20, 30	0.070	1600(1440)	1900(1710)	1R5
LVS303015H-2R2□-N	2.2	1	20, 30	0.075	1500(1350)	1800(1620)	2R2
LVS303015H-3R3□-N	3.3	1	20, 30	0.095	1100(990)	1600(1440)	3R3
LVS303015H-4R7□-N	4.7	1	20, 30	0.117	990(891)	1400(1260)	4R7
LVS303015H-6R8□-N	6.8	1	20, 30	0.160	900(810)	1200(1080)	6R8
LVS303015H-8R2□-N	8.2	1	20, 30	0.200	800(720)	1100(990)	8R2
LVS303015H-100□-N	10	1	20, 30	0.220	720(648)	1000(900)	100
LVS303015H-150□-N	15	1	20, 30	0.290	680(612)	850(765)	150
LVS303015H-220□-N	22	1	20, 30	0.530	480(432)	620(558)	220
LVS303015H-330□-N	33	1	20, 30	0.670	460(414)	500(450)	330
LVS303015H-470□-N	47	1	20, 30	0.960	380(342)	400(360)	470

- When ordering, please specify tolerance and packaging codes
- Tolerance : T = ±30% , M = ±20%
- L : Agilent/HP4287A+ Agilent/HP16197A, 1MHz 200mV
- RDC : Digital Milliohm Meter Chroma 16502, or equivalent
- Isat & I rms : Agilent/HP4284A, 1MHz 200mV
- Isat for Inductance drop 30% from its value without current
- I rms for a 40°C rise above 25°C ambient
- Operating temperature range from -40°C to 125°C . (Including self - temperature rise)

Test Instruments : HP4284A Material/Impedance Analyzer

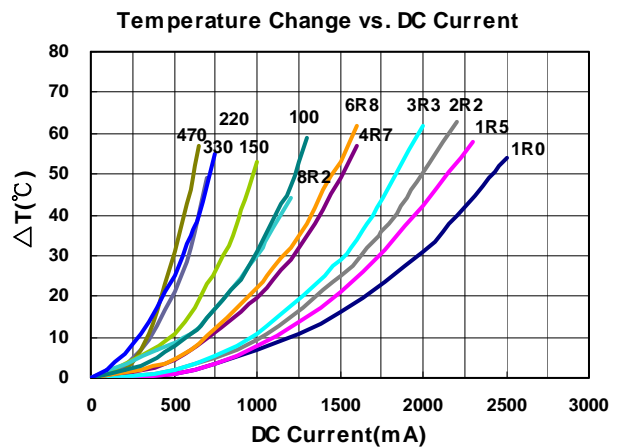
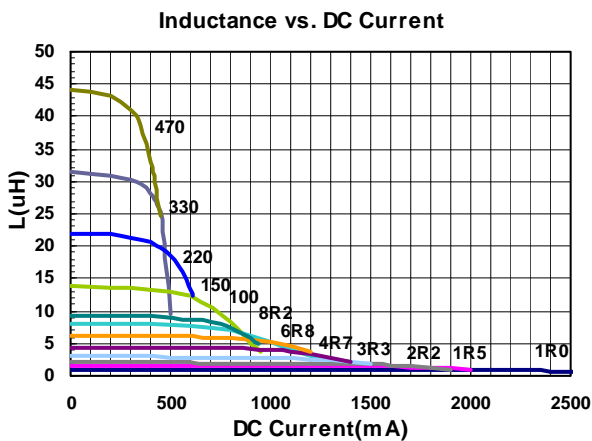

Electrical Characteristics

Part Number	Inductance (uH)	Test Frequency (KHz)	Tolerance (±%)	RDC (mΩ) ±30%	Isat (A) Typ. (Max)	Irms (A) Typ. (Max)	Marking
LVS404012-1R0□-N	1.0	100	30	48	2.50(2.25)	1.70(1.53)	1R0
LVS404012-1R5□-N	1.5	100	30	58	2.10(1.89)	1.60(1.44)	1R5
LVS404012-2R2□-N	2.2	100	20, 30	65	1.70(1.53)	1.50(1.35)	2R2
LVS404012-3R3□-N	3.3	100	20, 30	90	1.30(1.17)	1.40(1.26)	3R3
LVS404012-4R7□-N	4.7	100	20, 30	110	1.10(0.99)	1.20(1.08)	4R7
LVS404012-6R8□-N	6.8	100	20, 30	135	0.90(0.81)	1.05(0.94)	6R8
LVS404012-100□-N	10	100	20, 30	190	0.78(0.70)	0.90(0.81)	100
LVS404012-150□-N	15	100	20, 30	250	0.65(0.58)	0.85(0.76)	150
LVS404012-220□-N	22	100	20, 30	400	0.52(0.46)	0.75(0.67)	220
LVS404012-330□-N	33	100	20, 30	600	0.44(0.39)	0.70(0.63)	330
LVS404012-470□-N	47	100	20, 30	930	0.35(0.31)	0.50(0.45)	470

- When ordering, please specify tolerance and packaging codes
- Tolerance : M = ±20% , T = ±30%
- L : Agilent/HP 4284A + Agilent/HP 16334A, 100KHz with 1V
- Isat & Irms : Agilent/HP 4284A, 100KHz with 1V
- Rdc : Digital Milliohm Meter Chroma 16502, or equivalent
- Isat for Inductance drop 30% from its value without current
- Irms for a 40°C rise above 25°C ambient
- Operating temperature range from -40°C to 125°C. (Including self - temperature rise)

Test Instruments : HP4284A Material/Impedance Analyzer

Inductance vs. DC Current

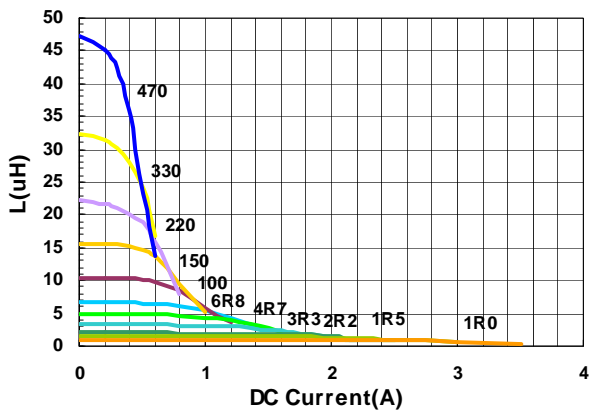

Temperature Change vs. DC Current

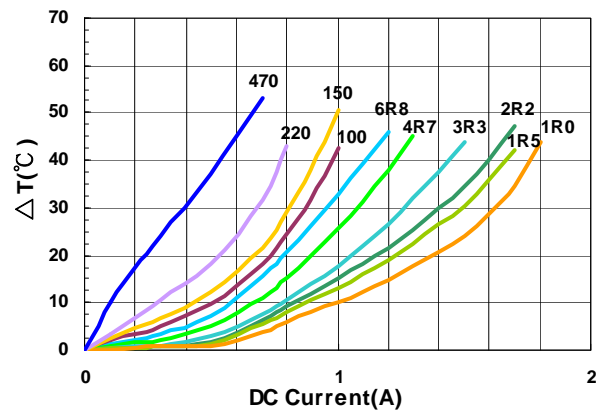

Electrical Characteristics

Part Number	Inductance (uH)	Test Frequency (KHz)	Tolerance (±%)	RDC (mΩ) ±20%	Isat (A) Typ. (Max)	Irms (A) Typ. (Max)	Marking
LVS404018-1R0□-N	1.0	100	20, 30	32	4.10(3.69)	2.80(2.52)	1R0
LVS404018-1R5□-N	1.5	100	20, 30	40	3.30(2.97)	2.60(2.34)	1R5
LVS404018-2R2□-N	2.2	100	20, 30	60	2.80(2.52)	2.50(2.25)	2R2
LVS404018-2R3□-N	2.3	100	20, 30	60	2.80(2.52)	2.50(2.25)	2R3
LVS404018-3R3□-N	3.3	100	20, 30	70	2.20(1.98)	2.10(1.89)	3R3
LVS404018-3R6□-N	3.6	100	20, 30	75	2.10(1.89)	1.90(1.71)	3R6
LVS404018-3R9□-N	3.9	100	20, 30	75	2.10(1.89)	1.90(1.71)	3R9
LVS404018-4R7□-N	4.7	100	20, 30	90	2.00(1.80)	1.70(1.53)	4R7
LVS404018-6R8□-N	6.8	100	20, 30	110	1.60(1.44)	1.50(1.35)	6R8
LVS404018-100□-N	10	100	20, 30	170	1.40(1.26)	1.20(1.08)	100
LVS404018-150□-N	15	100	20, 30	250	1.00(0.90)	1.00(0.90)	150
LVS404018-220□-N	22	100	20, 30	350	0.90(0.81)	0.85(0.76)	220
LVS404018-330□-N	33	100	20, 30	530	0.80(0.72)	0.70(0.63)	330
LVS404018-470□-N	47	100	20, 30	720	0.70(0.63)	0.56(0.50)	470
LVS404018-680□-N	68	100	20, 30	1000	0.56(0.50)	0.45(0.40)	680
LVS404018-101□-N	100	100	20, 30	1500	0.46(0.41)	0.38(0.34)	101
LVS404018-151□-N	150	100	20, 30	2500	0.35(0.31)	0.30(0.27)	151
LVS404018-221□-N	220	100	20, 30	4000	0.28(0.25)	0.23(0.20)	221

- When ordering, please specify tolerance and packaging codes
- Tolerance : M = ±20% , T = ±30%
- L : Agilent/HP 4284A + Agilent/HP 16334A, 100KHz with 1V
- Isat & Irms : Agilent/HP 4284A, 100KHz with 1V
- Rdc : Digital Milliohm Meter Chroma 16502, or equivalent
- Isat for Inductance drop 30% from its value without current
- Irms for a 40°C rise above 25°C ambient
- Operating temperature range from -40°C to 125°C. (Including self - temperature rise)

Test Instruments : HP4284A Material/Impedance Analyzer

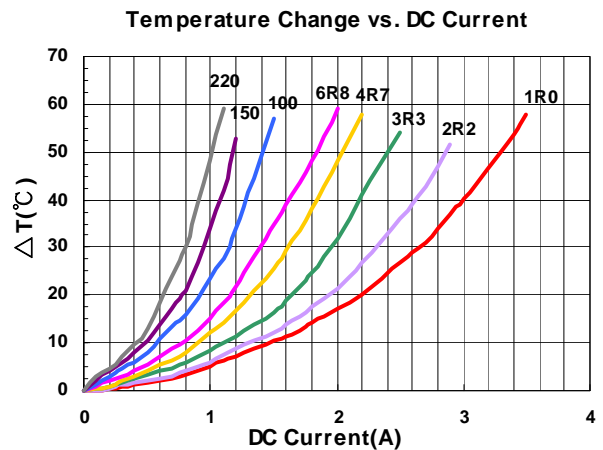
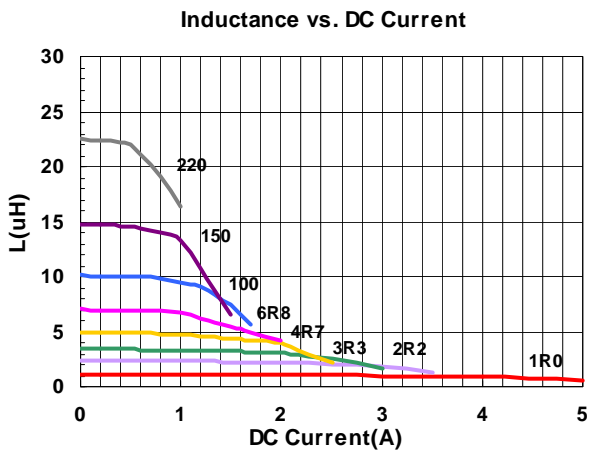

Electrical Characteristics

Part Number	Inductance (uH)	Test Frequency (KHz)	Tolerance (±%)	RDC (mΩ) ±30%	Isat (A) Typ. (Max)	Irms (A) Typ. (Max)	Marking
LVS404026-1R2□-N	1.2	100	20, 30	30	3.50(3.15)	3.30(2.97)	1R2
LVS404026-3R3□-N	3.3	100	20, 30	45	2.50(2.25)	2.50(2.25)	3R3
LVS404026-4R7□-N	4.7	100	20, 30	60	1.80(1.62)	1.80(1.62)	4R7
LVS404026-220□-N	22	100	20, 30	230	0.86(0.77)	1.00(0.90)	220

- When ordering, please specify tolerance and packaging codes
- Tolerance : M = ±20% , T = ±30%
- L : Agilent/HP 4284A + Agilent/HP 16334A, 100KHz with 1V
- Isat & Irms : Agilent/HP 4284A , 100KHz with 1V
- Rdc : Digital Milliohm Meter Chroma 16502, or equivalent
- Isat for Inductance drop 30% from its value without current
- Irms for a 40°C rise above 25°C ambient
- Operating temperature range from -40°C to 125°C. (Including self - temperature rise)

Test Instruments : HP4284A Material/Impedance Analyzer

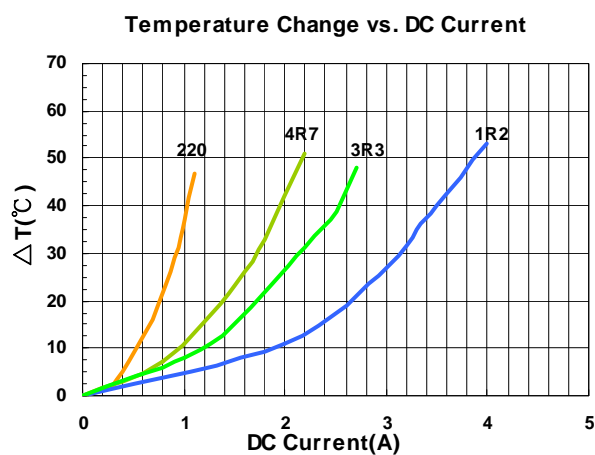
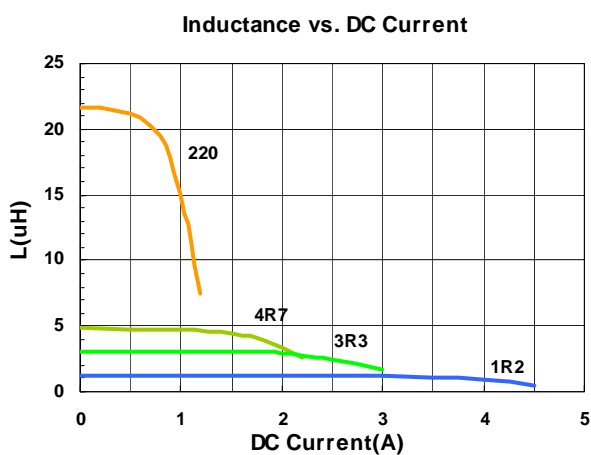

Electrical Characteristics

Part Number	Inductance (uH)	Test Frequency (KHz)	Tolerance (±%)	RDC (mΩ) ±20%	Isat (A) Typ. (Max)	Irms (A) Typ. (Max)	Marking
LVS505020-1R0□-N	1.0	100	30	21	5.1(4.59)	4.0(3.60)	1R0
LVS505020-1R2□-N	1.2	100	30	21	4.8(4.32)	3.8(3.42)	1R2
LVS505020-1R5□-N	1.5	100	30	26	4.2(3.78)	3.5(3.15)	1R5
LVS505020-2R2□-N	2.2	100	20, 30	35	3.4(3.06)	3.2(2.88)	2R2
LVS505020-3R3□-N	3.3	100	20, 30	48	3.0(2.70)	2.8(2.52)	3R3
LVS505020-4R7□-N	4.7	100	20, 30	60	2.2(1.98)	2.2(1.98)	4R7
LVS505020-5R6□-N	5.6	100	20, 30	82	2.05(1.84)	2.0(1.80)	5R6
LVS505020-6R8□-N	6.8	100	20, 30	90	2.0(1.80)	1.8(1.62)	6R8
LVS505020-100□-N	10	100	20, 30	120	1.6(1.44)	1.6(1.44)	100
LVS505020-150□-N	15	100	20, 30	190	1.3(1.17)	1.2(1.08)	150
LVS505020-220□-N	22	100	20, 30	260	1.0(0.90)	1.0(0.90)	220
LVS505020-330□-N	33	100	20, 30	460	0.8(0.72)	0.75(0.67)	330
LVS505020-470□-N	47	100	20, 30	580	0.65(0.58)	0.65(0.60)	470

- When ordering, please specify tolerance and packaging codes
- Tolerance : M = ±20% , T = ±30%
- L : Agilent/HP 4284A + Agilent/HP 16334A, 100KHz with 1V
- Isat & Irms : Agilent/HP 4284A, 100KHz with 1V
- Rdc : Digital Milliohm Meter Chroma 16502, or equivalent
- Isat for Inductance drop 30% from its value without current
- Irms for a 40°C rise above 25°C ambient
- Operating temperature range from -40°C to 125°C. (Including self - temperature rise)

Test Instruments : HP4284A Material/Impedance Analyzer

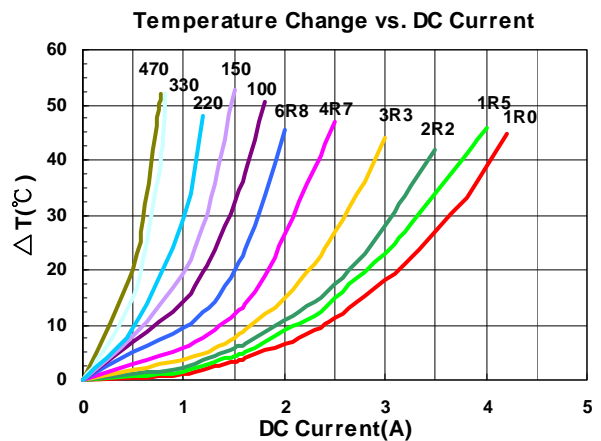
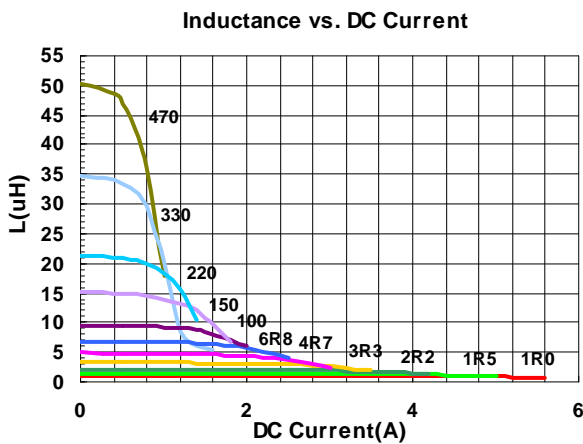

Electrical Characteristics

Part Number	Inductance (uH)	Test Frequency (KHz)	Tolerance (±%)	RDC (mΩ) ±30%	Isat (A) Typ. (Max)	Irms (A) Typ. (Max)	Marking
LVS505040-1R0□-N	1.0	100	30	14	7.5(6.75)	4.6(4.14)	1R0
LVS505040-1R2□-N	1.2	100	30	15	7.4(6.66)	4.5(4.05)	1R2
LVS505040-1R5□-N	1.5	100	30	16	7.1(6.39)	4.4(3.96)	1R5
LVS505040-2R2□-N	2.2	100	20, 30	21	5.7(5.13)	3.7(3.33)	2R2
LVS505040-3R3□-N	3.3	100	20, 30	26	4.8(4.32)	3.5(3.15)	3R3
LVS505040-4R7□-N	4.7	100	20, 30	32	4.2(3.78)	3.2(2.88)	4R7
LVS505040-6R8□-N	6.8	100	20, 30	50	3.3(2.97)	2.4(2.16)	6R8
LVS505040-100□-N	10	100	20, 30	60	2.8(2.52)	2.2(1.98)	100
LVS505040-150□-N	15	100	20, 30	90	2.3(2.07)	1.8(1.62)	150
LVS505040-220□-N	22	100	20, 30	135	1.8(1.62)	1.4(1.26)	220
LVS505040-270□-N	27	100	20, 30	180	1.6(1.44)	1.2(1.08)	270
LVS505040-330□-N	33	100	20, 30	190	1.5(1.35)	1.1(0.99)	330
LVS505040-470□-N	47	100	20, 30	310	1.2(1.08)	0.9(0.81)	470

- When ordering, please specify tolerance and packaging codes
- Tolerance : M = ±20% , T = ±30%
- L : Agilent/HP 4284A + Agilent/HP 16334A, 100KHz with 1V
- Isat & Irms : Agilent/HP 4284A, 100KHz with 1V
- Rdc : Digital Milliohm Meter Chroma 16502, or equivalent
- Isat for Inductance drop 30% from its value without current
- Irms for a 40°C rise above 25°C ambient
- Operating temperature range from -40°C to 125°C. (Including self - temperature rise)

Test Instruments : HP4284A Material/Impedance Analyzer

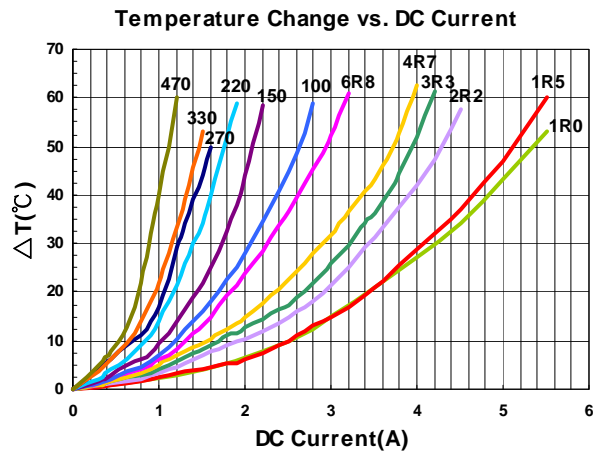
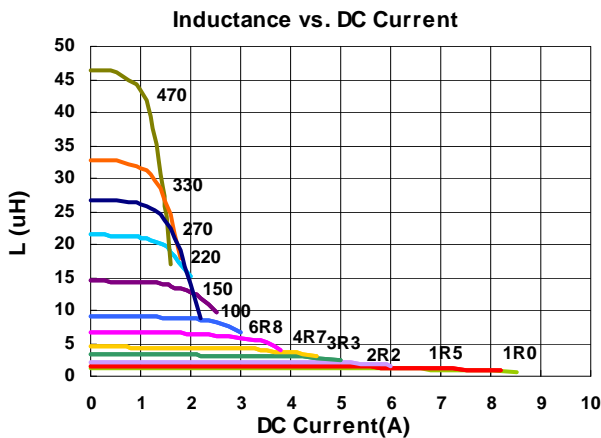

Electrical Characteristics

Part Number	Inductance (uH)	Test Frequency (KHz)	Tolerance (±%)	RDC (mΩ) ±30%	Isat (A) Typ. (Max)	Irms (A) Typ. (Max)	Marking
LVS606020-R50□-N	0.5	100	30	13	8.0(7.20)	5.3(4.77)	R50
LVS606020-R90□-N	0.9	100	30	18	6.3(5.67)	4.2(3.78)	R90
LVS606020-1R0□-N	1.0	100	30	19	6.2(5.58)	4.1(3.69)	1R0
LVS606020-1R5□-N	1.5	100	20, 30	26	5.0(4.50)	3.6(3.24)	1R5
LVS606020-2R2□-N	2.2	100	20, 30	34	4.2(3.78)	3.2(2.88)	2R2
LVS606020-3R3□-N	3.3	100	20, 30	40	3.2(2.88)	2.7(2.43)	3R3
LVS606020-4R7□-N	4.7	100	20, 30	58	2.5(2.25)	2.2(1.98)	4R7
LVS606020-6R8□-N	6.8	100	20, 30	85	2.2(1.98)	1.8(1.62)	6R8
LVS606020-100□-N	10	100	20, 30	125	2.0(1.80)	1.6(1.44)	100
LVS606020-150□-N	15	100	20, 30	190	1.3(1.17)	1.3(1.17)	150
LVS606020-220□-N	22	100	20, 30	260	1.1(0.99)	1.1(0.99)	220

- When ordering, please specify tolerance and packaging codes
- Tolerance : M = ±20% , T = ±30%
- L : Agilent/HP 4284A + Agilent/HP 16334A, 100KHz with 1V
- Isat & Irms : Agilent/HP 4284A, 100KHz with 1V
- Rdc : Digital Milliohm Meter Chroma 16502, or equivalent
- Isat for Inductance drop 30% from its value without current
- Irms for a 40°C rise above 25°C ambient
- Operating temperature range from -40°C to 125°C. (Including self - temperature rise)

Test Instruments : HP4284A Material/Impedance Analyzer

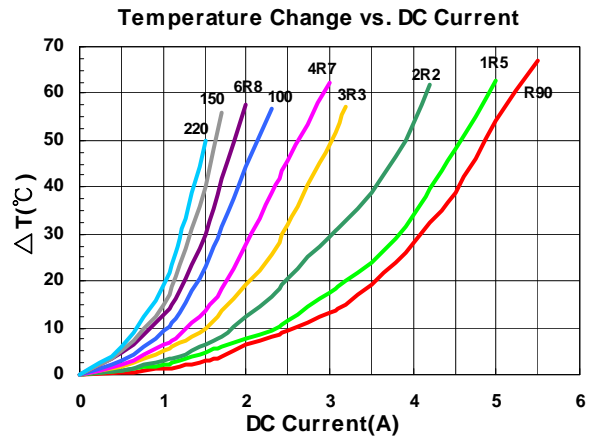
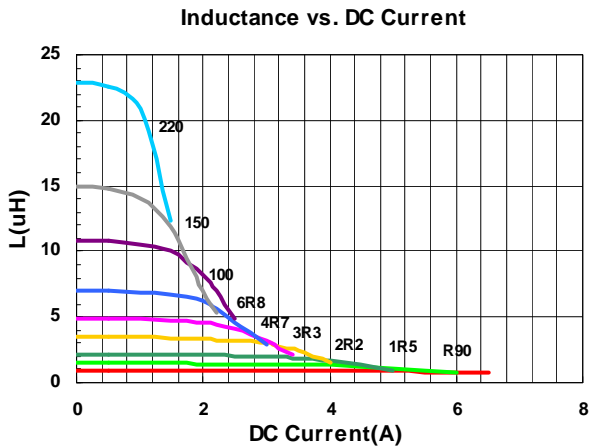

Electrical Characteristics

Part Number	Inductance (uH)	Test Frequency (KHz)	Tolerance (±%)	RDC (mΩ) ±30%	Isat (A) Typ. (Max)	Irms (A) Typ. (Max)	Marking
LVS606028-1R0□-N	1.0	100	30	13	7.6(6.84)	5.2(4.68)	1R0
LVS606028-1R5□-N	1.5	100	30	16	6.3(5.67)	4.8(4.32)	1R5
LVS606028-2R2□-N	2.2	100	20, 30	20	5.4(4.86)	4.0(3.60)	2R2
LVS606028-2R7□-N	2.7	100	20, 30	26	4.9(4.41)	3.7(3.33)	2R7
LVS606028-3R3□-N	3.3	100	20, 30	28	4.3(3.87)	3.5(3.15)	3R3
LVS606028-4R7□-N	4.7	100	20, 30	38	3.7(3.33)	3.2(2.88)	4R7
LVS606028-6R0□-N	6.0	100	20, 30	45	3.3(2.97)	2.8(2.52)	6R0
LVS606028-6R8□-N	6.8	100	20, 30	50	3.1(2.79)	2.7(2.43)	6R8
LVS606028-100□-N	10	100	20, 30	65	2.5(2.25)	2.3(2.07)	100
LVS606028-150□-N	15	100	20, 30	95	2.0(1.80)	1.8(1.62)	150
LVS606028-220□-N	22	100	20, 30	135	1.6(1.44)	1.5(1.35)	220
LVS606028-330□-N	33	100	20, 30	220	1.3(1.17)	1.4(1.26)	330
LVS606028-470□-N	47	100	20, 30	320	1.1(0.99)	1.0(0.90)	470
LVS606028-680□-N	68	100	20, 30	420	0.98(0.88)	0.9(0.81)	680
LVS606028-101□-N	100	100	20, 30	600	0.82(0.73)	0.8(0.72)	101

- When ordering, please specify tolerance and packaging codes
- Tolerance : M = ±20% , T = ±30%
- L : Agilent/HP 4284A + Agilent/HP 16334A, 100KHz with 1V
- Isat & Irms : Agilent/HP 4284A, 100KHz with 1V
- Rdc : Digital Milliohm Meter Chroma 16502, or equivalent
- Isat for Inductance drop 30% from its value without current
- Irms for a 40°C rise above 25°C ambient
- Operating temperature range from -40°C to 125°C. (Including self - temperature rise)

Test Instruments : HP4284A Material/Impedance Analyzer

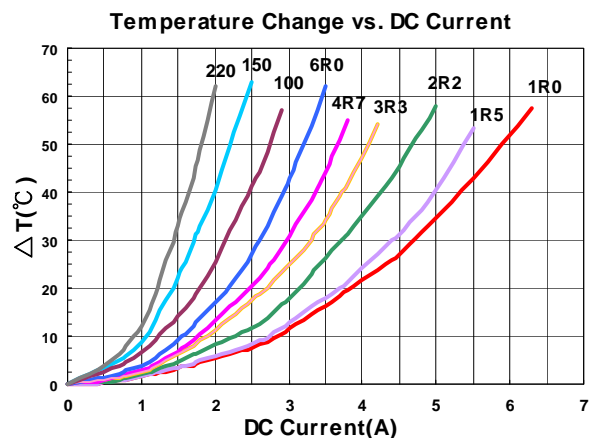
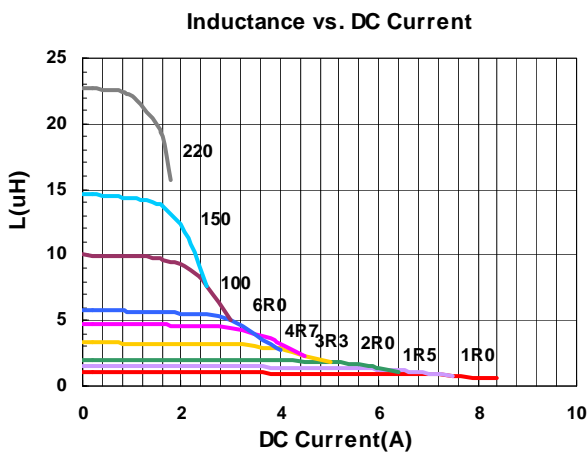

Electrical Characteristics

Part Number	Inductance (uH)	Test Frequency (KHz)	Tolerance (±%)	RDC (mΩ) ±30%	Isat (A) Typ. (Max)	Irms (A) Typ. (Max)	Marking
LVS606045-1R0□-N	1.0	100	20, 30	12	12.2(10.98)	6.5(5.85)	1R0
LVS606045-1R5□-N	1.5	100	30	15	10.4(9.36)	5.9(5.31)	1R5
LVS606045-1R8□-N	1.8	100	20, 30	17	9.6(8.64)	5.6(5.04)	1R8
LVS606045-2R2□-N	2.2	100	20, 30	18.4	8.8(7.92)	5.1(4.59)	2R2
LVS606045-2R3□-N	2.3	100	20, 30	19	8.8(7.92)	5.0(4.50)	2R3
LVS606045-3R0□-N	3.0	100	20, 30	22	7.8(7.02)	4.4(3.96)	3R0
LVS606045-3R3□-N	3.3	100	20, 30	24	7.5(6.75)	4.3(3.87)	3R3
LVS606045-3R6□-N	3.6	100	20, 30	24	7.5(6.75)	4.3(3.87)	3R6
LVS606045-3R9□-N	3.9	100	20, 30	26	7.0(6.30)	4.0(3.60)	3R9
LVS606045-4R5□-N	4.5	100	20, 30	31	6.7(6.03)	3.9(3.51)	4R5
LVS606045-4R7□-N	4.7	100	20, 30	31	6.7(6.03)	3.9(3.51)	4R7
LVS606045-5R1□-N	5.1	100	20, 30	33	6.0(5.40)	3.5(3.15)	5R1
LVS606045-6R3□-N	6.3	100	20, 30	40	5.5(4.95)	3.3(2.97)	6R3
LVS606045-6R8□-N	6.8	100	20, 30	43	5.3(4.77)	3.2(2.88)	6R8
LVS606045-100□-N	10	100	20, 30	57	4.5(4.05)	2.7(2.43)	100
LVS606045-150□-N	15	100	20, 30	80	3.4(3.06)	2.2(1.98)	150
LVS606045-180□-N	18	100	20, 30	100	3.1(2.79)	1.8(1.62)	180
LVS606045-220□-N	22	100	20, 30	125	3.0(2.70)	1.9(1.71)	220
LVS606045-270□-N	27	100	20, 30	160	2.5(2.25)	1.3(1.17)	270
LVS606045-330□-N	33	100	20, 30	165	2.3(2.07)	1.4(1.26)	330
LVS606045-470□-N	47	100	20, 30	245	1.9(1.71)	1.2(1.08)	470
LVS606045-680□-N	68	100	20, 30	330	1.6(1.44)	1.0(0.90)	680
LVS606045-101□-N	100	100	20, 30	500	1.3(1.17)	0.8(0.72)	101
LVS606045-331□-N	330	100	20, 30	1800	0.7(0.63)	0.35(0.31)	331
LVS606045-102□-N	1000	100	20, 30	6000	0.4(0.36)	0.22(0.19)	102

- When ordering, please specify tolerance and packaging codes
- Tolerance : M = ±20% , T = ±30%
- L : Agilent/HP 4284A + Agilent/HP 16334A, 100KHz with 1V
- Isat & Irms : Agilent/HP 4284A, 100KHz with 1V
- Rdc : Digital Milliohm Meter Chroma 16502, or equivalent
- Isat for Inductance drop 30% from its value without current
- Irms for a 40°C rise above 25°C ambient
- Operating temperature range from -40°C to 125°C. (Including self - temperature rise)

Test Instruments : HP4284A Material/Impedance Analyzer

Inductance vs. DC Current

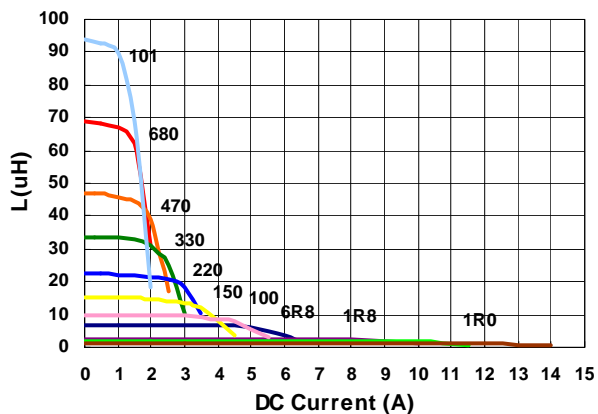

Temperature Change vs. DC Current

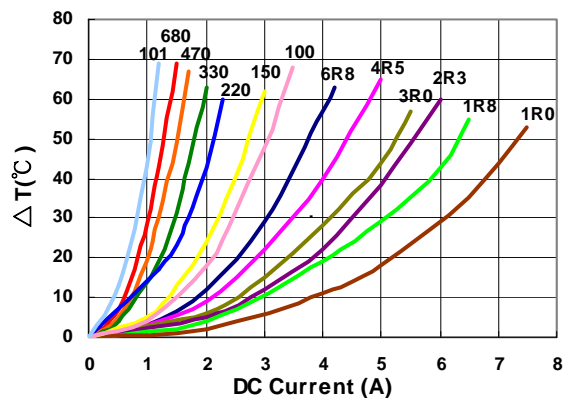

Electrical Characteristics

Part Number	Inductance (uH)	Test Frequency (KHz)	Tolerance (±%)	RDC (mΩ) Max	Isat (A) Typ. (Max)	Irms (A) Typ. (Max)	Marking
LVS606045L-R50□-N	0.5	100	30	9	11(9.90)	8.0(7.20)	R50
LVS606045L-2R2□-N	2.2	100	20, 30	17	6.8(6.12)	5.5(4.95)	2R2
LVS606045L-3R3□-N	3.3	100	20, 30	24	5.5(4.95)	4.7(4.23)	3R3
LVS606045L-4R7□-N	4.7	100	20, 30	30	4.6(4.14)	4.0(3.60)	4R7
LVS606045L-6R8□-N	6.8	100	20, 30	40	4.0(3.60)	3.5(3.15)	6R8
LVS606045L-100□-N	10	100	20, 30	50	3.2(2.88)	3.2(2.88)	100
LVS606045L-150□-N	15	100	20, 30	80	2.6(2.34)	2.5(2.25)	150
LVS606045L-220□-N	22	100	20, 30	120	2.1(1.89)	2.0(1.80)	220
LVS606045L-330□-N	33	100	20, 30	170	1.7(1.53)	1.6(1.44)	330
LVS606045L-101□-N	100	100	20, 30	595	0.95(0.85)	0.92(0.82)	101

- When ordering, please specify tolerance and packaging codes
- Tolerance : M = ±20% , T = ±30%
- L : Agilent/HP 4284A + Agilent/HP 16334A, 100KHz with 1V
- Isat & Irms : Agilent/HP 4284A, 100KHz with 1V
- Rdc : Digital Milliohm Meter Chroma 16502, or equivalent
- Isat for Inductance drop 30% from its value without current
- Irms for a 40°C rise above 25°C ambient
- Operating temperature range from -40°C to 125°C. (Including self - temperature rise)

Test Instruments : HP4284A Material/Impedance Analyzer

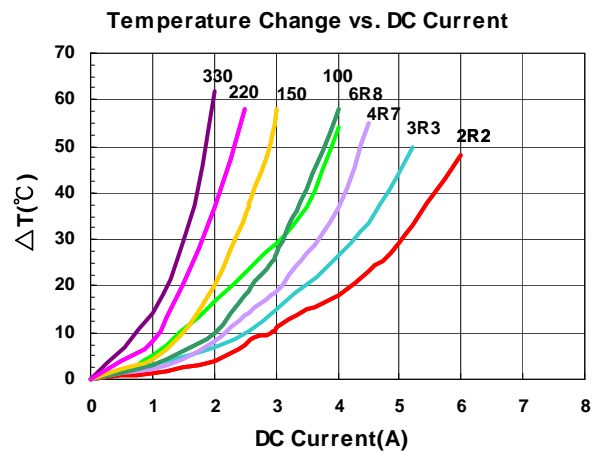
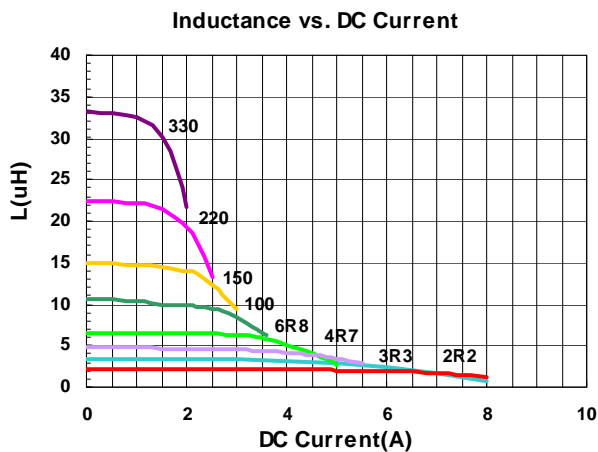

Electrical Characteristics

Part Number	Inductance (uH)	Test Frequency (KHz)	Tolerance (±%)	RDC (mΩ) ±30%	Isat (A) Typ. (Max)	Irms (A) Typ. (Max)	Marking
LVS808040-R90□-N	0.9	100	30	7	13.8(12.42)	8.05(7.24)	R90
LVS808040-1R0□-N	1.0	100	30	7.5	13.0(11.70)	7.95(7.15)	1R0
LVS808040-1R4□-N	1.4	100	30	9	10.8(9.72)	7.8(7.02)	1R4
LVS808040-1R5□-N	1.5	100	30	9.5	10.08(9.07)	7.7(6.93)	1R5
LVS808040-2R0□-N	2.0	100	20, 30	11	9.6(8.64)	7.4(6.66)	2R0
LVS808040-2R2□-N	2.2	100	20, 30	11.5	9.2(8.28)	7.2(6.48)	2R2
LVS808040-2R5□-N	2.5	100	20, 30	13	8.2(7.38)	6.3(5.67)	2R5
LVS808040-3R3□-N	3.3	100	20, 30	15	7.5(6.75)	6.0(5.40)	3R3
LVS808040-4R7□-N	4.7	100	20, 30	18	6.0(5.40)	5.5(4.95)	4R7
LVS808040-5R6□-N	5.6	100	20, 30	23	5.7(5.13)	5.2(4.68)	5R6
LVS808040-6R8□-N	6.8	100	20, 30	25	5.4(4.86)	5.1(4.59)	6R8
LVS808040-100□-N	10	100	20, 30	38	4.3(3.87)	3.8(3.42)	100
LVS808040-120□-N	12	100	20, 30	45	3.8(3.42)	3.5(3.15)	120
LVS808040-150□-N	15	100	20, 30	50	3.6(3.24)	3.2(2.88)	150
LVS808040-180□-N	18	100	20, 30	68	3.1(2.79)	2.7(2.43)	180
LVS808040-220□-N	22	100	20, 30	80	2.8(2.52)	2.6(2.34)	220
LVS808040-330□-N	33	100	20, 30	110	2.3(2.07)	2.0(1.80)	330
LVS808040-470□-N	47	100	20, 30	160	1.9(1.71)	1.75(1.57)	470
LVS808040-680□-N	68	100	20, 30	240	1.7(1.53)	1.45(1.30)	680
LVS808040-101□-N	100	100	20, 30	340	1.4(1.26)	1.10(0.99)	101
LVS808040-121□-N	120	100	20, 30	425	1.1(0.99)	1.0(0.90)	121
LVS808040-151□-N	150	100	20, 30	480	1.0(0.90)	0.9(0.81)	151
LVS808040-221□-N	220	100	20, 30	670	0.94(0.84)	0.60(0.54)	221
LVS808040-271□-N	270	100	20, 30	900	0.83(0.74)	0.55(0.49)	271
LVS808040-821□-N	820	100	20, 30	2800	0.40(0.36)	0.38(0.34)	821

- When ordering, please specify tolerance and packaging codes
- Tolerance : T = ±30% , M = ±20%
- L : Agilent/HP4284A+ Agilent/HP16334A, 100KHz, 1V
- RDC : Digital Milliohm Meter Chroma 16502, or equivalent
- Isat & Irms : Agilent/HP4284A, 100KHz, 1V
- Isat for Inductance drop 30% from its value without current
- Irms for a 40°C rise above 25°C ambient
- Operating temperature range from -40°C to 125°C . (Including self - temperature rise)

Test Instruments : HP4284A Material/Impedance Analyzer

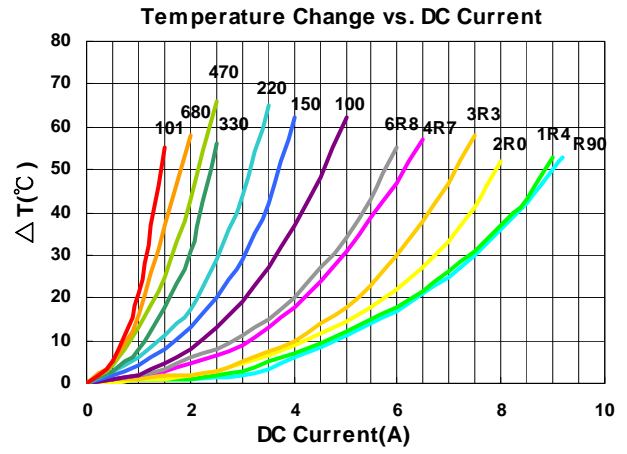
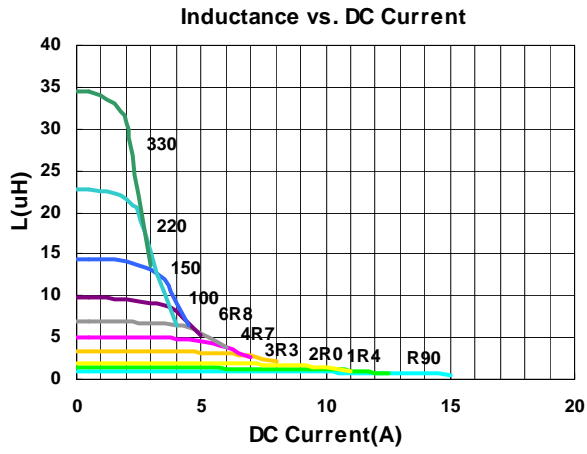

Electrical Characteristics

Part Number	Inductance (uH)	Test Frequency (KHz)	Tolerance (±%)	RDC (mΩ) Max	Isat (A) Typ. (Max)	Irms (A) Typ. (Max)	Marking
LVS808040L-1R0□-N	1.0	100	30	10	9.5(8.55)	8.5(7.65)	1R0
LVS808040L-2R2□-N	2.2	100	20,30	12	7.2(6.48)	7.3(6.57)	2R2
LVS808040L-3R3□-N	3.3	100	20,30	19	5.6(5.04)	6.0(5.40)	3R3
LVS808040L-4R7□-N	4.7	100	20,30	22	4.4(3.96)	5.0(4.50)	4R7
LVS808040L-8R2□-N	8.2	100	20,30	37	3.6(3.24)	3.8(3.42)	8R2
LVS808040L-100□-N	10	100	20,30	42	3.1(2.79)	3.5(3.15)	100
LVS808040L-150□-N	15	100	20,30	58	2.5(2.25)	3.0(2.70)	150
LVS808040L-220□-N	22	100	20,30	85	2.0(1.80)	2.5(2.25)	220

- When ordering, please specify tolerance and packaging codes
- Tolerance : T = ±30% , M = ±20%
- L : Agilent/HP4284A+ Agilent/HP16334A, 100KHz, 1V
- RDC : Digital Milliohm Meter Chroma 16502, or equivalent
- Isat & I rms : Agilent/HP4284A, 100KHz, 1V
- Isat for Inductance drop 30% from its value without current
- I rms for a 40°C rise above 25°C ambient
- Operating temperature range from -40°C to 125°C. (Including self - temperature rise)

Test Instruments : HP4284A Material/Impedance Analyzer

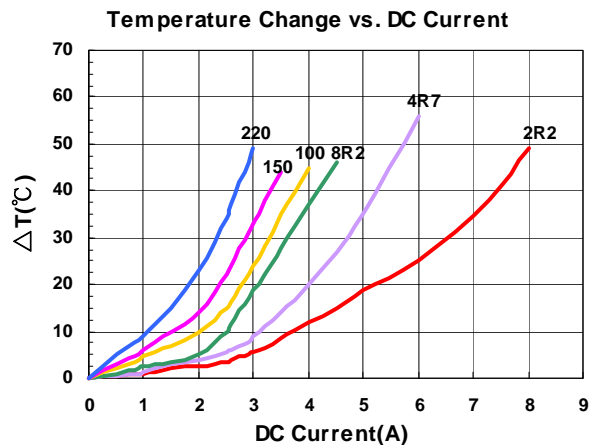
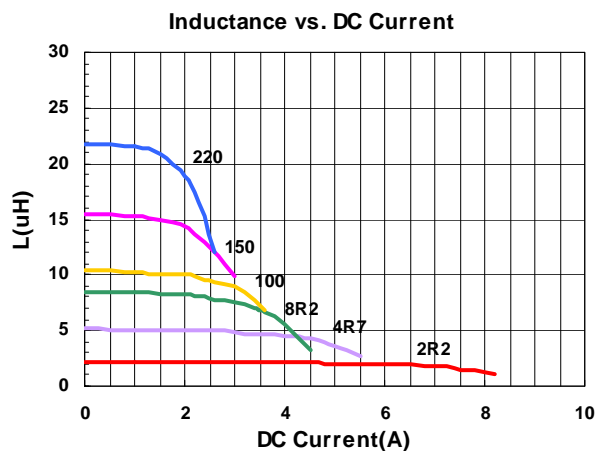

Packaging Specifications

Tape Dimensions

Figure 1

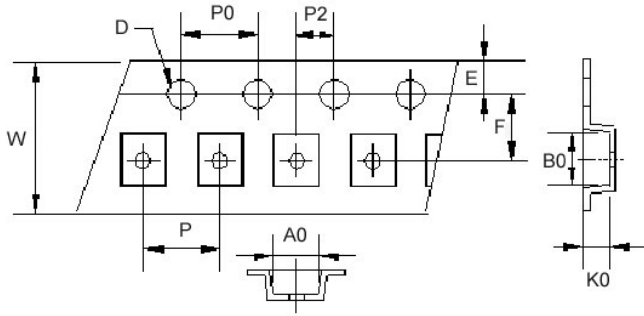

Reel Dimensions

Figure 1

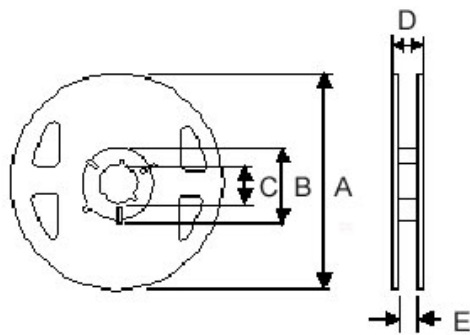

Tape Dimensions

Figure 2

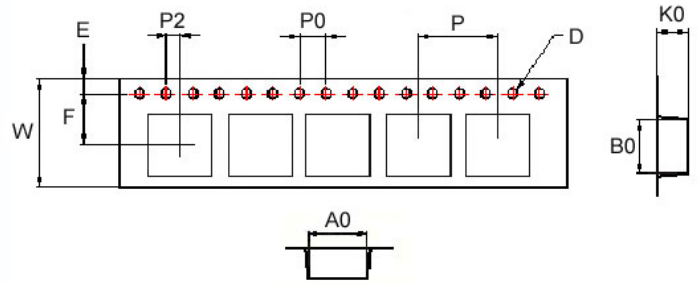

Reel Dimensions

Figure 2

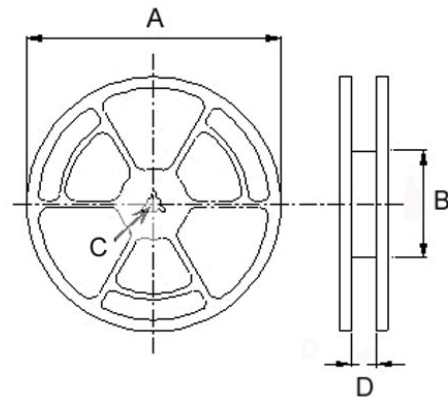

Dimensions in mm

TYPE	Fig	Tape Dimensions										Reel Dimensions					Quantity PCS / Reel
		A0	B0	K0	D	E	F	W	P	P0	P2	A	B	C	D	E	
LVS201610	1	1.80	2.20	1.15	1.55	1.75	3.5	8.1	4	4	2	180	60	13	14.4	8.4	2000
LVS252010	1	2.30	2.70	1.15	1.55	1.75	3.5	8.1	4	4	2	180	60	13	14.4	8.4	2000
LVS252012	1	2.30	2.70	1.30	1.55	1.75	3.5	8.1	4	4	2	180	60	13	14.4	8.4	2000
LVS303010	1	3.20	3.20	1.40	1.55	1.75	3.5	8.0	4	4	2	180	60	13	14.4	8.4	2000
LVS303012	1	3.20	3.20	1.40	1.55	1.75	3.5	8.0	4	4	2	180	60	13	14.4	8.4	2000
LVS303015	1	3.15	3.15	1.60	1.55	1.75	3.5	8.0	4	4	2	180	60	13	14.4	8.4	2000
LVS404012	2	4.25	4.25	1.30	1.55	1.75	5.5	12	8	4	2	180	60	13	13.2	-	1000
LVS404018	2	4.25	4.25	2.10	1.55	1.75	5.5	12	8	4	2	180	60	13	13.2	-	800
LVS404026	2	4.25	4.25	3.00	1.55	1.75	5.5	12	8	4	2	180	60	13	13.2	-	500
LVS505020	2	5.25	5.25	2.20	1.55	1.75	5.5	12	8	4	2	330	100	13	13.4	-	2000
LVS505040	2	5.20	5.20	4.20	1.55	1.75	5.5	12	8	4	2	330	100	13	13.4	-	1500
LVS606020	2	6.25	6.25	2.20	1.55	1.75	7.5	16	12	4	2	330	100	13	17.4	-	2000
LVS606028	2	6.25	6.25	3.00	1.55	1.75	7.5	16	12	4	2	330	100	13	17.4	-	1500
LVS606045	2	6.25	6.25	4.65	1.55	1.75	7.5	16	12	4	2	330	100	13	17.4	-	1000
LVS808040	2	8.25	8.25	4.15	1.55	1.75	7.5	16	12	4	2	330	100	13	17.4	-	1000

X-ON Electronics

Largest Supplier of Electrical and Electronic Components

Click to view similar products for [Fixed Inductors](#) category:

Click to view products by [Chilisin](#) manufacturer:

Other Similar products are found below :

[MLZ1608M6R8WTD25](#) [MLZ1608N6R8LT000](#) [MLZ1608N3R3LTD25](#) [MLZ1608N3R3LT000](#) [MLZ1608N150LT000](#)

[MLZ1608M150WTD25](#) [MLZ1608M3R3WTD25](#) [MLZ1608M3R3WT000](#) [MLZ1608M150WT000](#) [MLZ1608A1R5WT000](#)

[MLZ1608N1R5LT000](#) [B82432C1333K000](#) [PCMB053T-1R0MS](#) [PCMB053T-1R5MS](#) [PCMB104T-1R5MS](#) [CR32NP-100KC](#) [CR32NP-](#)

[151KC](#) [CR32NP-180KC](#) [CR32NP-181KC](#) [CR32NP-1R5MC](#) [CR32NP-390KC](#) [CR32NP-3R9MC](#) [CR32NP-680KC](#) [CR32NP-820KC](#)

[CR32NP-8R2MC](#) [CR43NP-390KC](#) [CR43NP-560KC](#) [CR43NP-680KC](#) [CR54NP-181KC](#) [CR54NP-470LC](#) [CR54NP-820KC](#) [CR54NP-8R5MC](#)

[MGDQ4-00004-P](#) [MGDU1-00016-P](#) [MHL1ECTTP18NJ](#) [MHL1JCTTD12NJ](#) [PE-51506NL](#) [PE-53601NL](#) [PE-53630NL](#) [PE-53824SNLT](#) [PE-](#)

[62892NL](#) [PE-92100NL](#) [PG0434.801NLT](#) [PG0936.113NLT](#) [PM06-2N7](#) [PM06-39NJ](#) [HC2LP-R47-R](#) [HC2-R47-R](#) [HC3-2R2-R](#) [HC8-1R2-R](#)