

PRODUCT SPECIFICATION

新弘智

SPEC. NO: T-0602-141E

DATE: Mar.14,2019

CUSTOMER'S PRODUCT NAME:

EMTEK PRODUCT NAME:

CMF4532F-SERIES-Tms

THIS SPECIFICATION IS:

- FULLY ACCEPTED
 DENIED
 ACCEPTED UNDER THE FOLLOWING CONDITIONS



SIGNATURE: _____ DATE: _____

NAME(PRINT): _____

TITLE: _____



EMTEK CO., LTD.

FACTORY:

39,Chingao Rd.,(305)Hsinpu,
Hsinchu Hsien,Taiwan,R.O.C

TEL: 03-5894-433

FAX: 03-5894-523

本文件內容全部或部份,未經兆欣科技股份有限公司
同意不得以任何形式複製或其他用途
All rights reserved.This document or parts thereof,may
not be reproduced by any means or used in any manner
witout written permission of EMTEK CO.,LTD.

PRODUCT SPECIFICATION

SPEC. NO.

T-0602-141E



1. Scope

This specification applies ferrite Chip common mode filters CMF4532F-Series-Tms to be delivered to user.

2. Product Identification

CMF 4532 F - 600 - 2P - Tms

(1) (2) (3) (4) (5) (6)

- (1) Product name
- (2) Shapes and dimensions
- (3) Shielding Type
- (4) Impedance 【 at 100MHz 】
600:60Ω
- (5) Number of Line
2P:2-Line
- (6) For Customer Design

3. Shapes and Dimensions [Dimensions in mm]

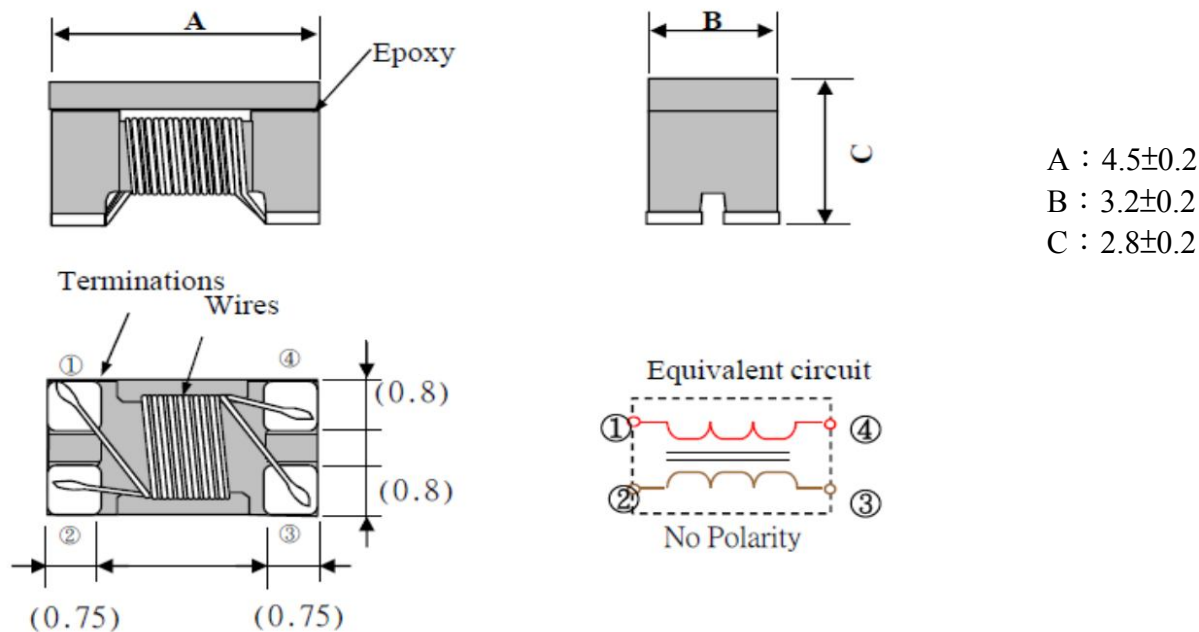

Drawn by	Checked by	Approved by
Cindy Dec. 1. 2016	Zheng Dec. 1. 2016	Su Dec 1. 2016

PRODUCT SPECIFICATION

SPEC. NO.

T-0602-141E



4. Electrical Characteristics

4-1 Electrical Spec.

Our Product Part Number	Common-Mode Impedance Z(Ω) at 100MHz	Common-Mode Inductance uH at 100KHz	DC Resistance Rdc(Ω) Max.	Rated Current Idc(A) Max.	Rated Voltage Vdc(V)	Withstanding Voltage Vdc(V)	Insulation Resistance (M Ω)Min.
CMF4532F-600-2P-Tms	60 \pm 25%		0.05	2.0	50	125	10
CMF4532F-900-2P-Tms	90 \pm 25%		0.05	2.0	50	125	10
CMF4532F-161-2P-Tms	160 \pm 25%		0.08	2.0	50	125	10
CMF4532F-231-2P-Tms	230 \pm 25%		0.10	1.8	50	125	10
CMF4532F-421-2P-Tms	420 \pm 25%		0.10	1.6	50	125	10
CMF4532F-601-2P-Tms	600 \pm 25%	2.0 \pm 50%	0.07	2.8	50	125	10

Rated Current Idc : DC current (A) that will cause an approximate ΔT of 40°C

4-2 Characteristics (Reference)

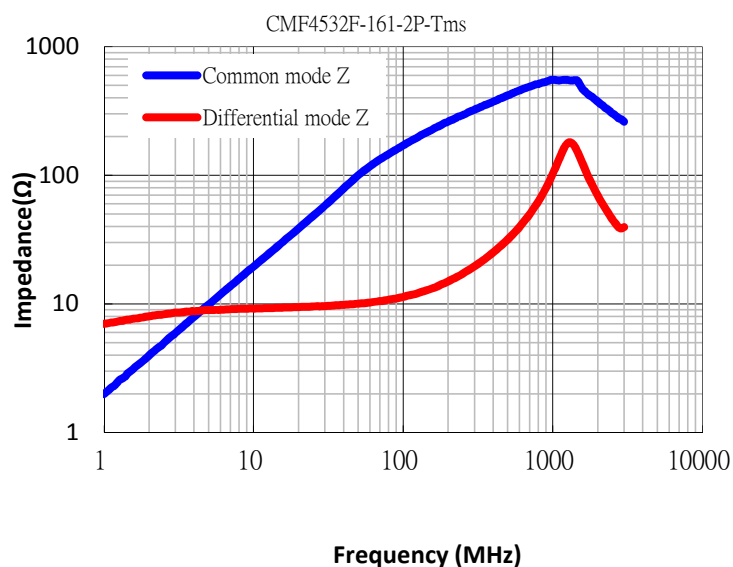
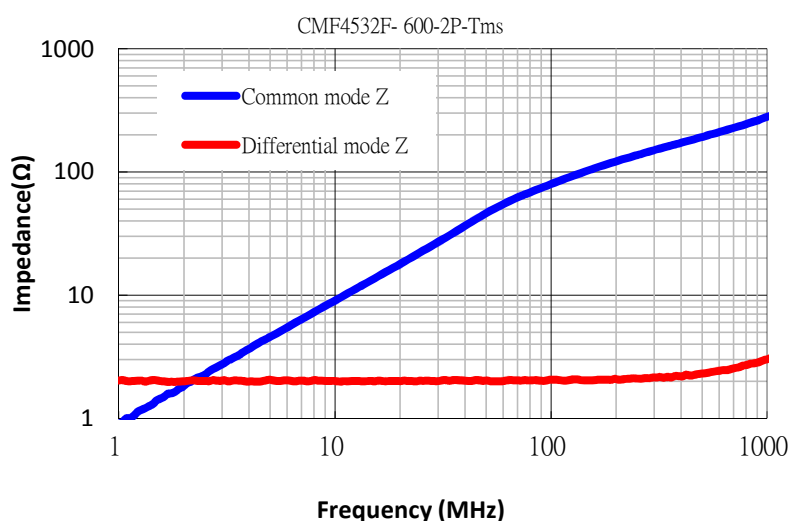

PRODUCT SPECIFICATION

SPEC. NO.

T-0602-141E



4-2 Characteristics (Reference)

CMF4532F-421-2P-Tms

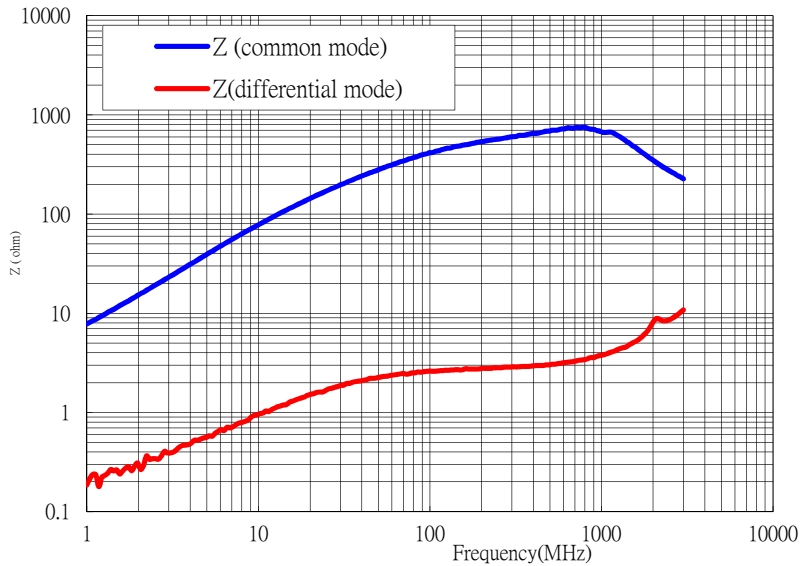

CMF4532F-601-2P-Tms

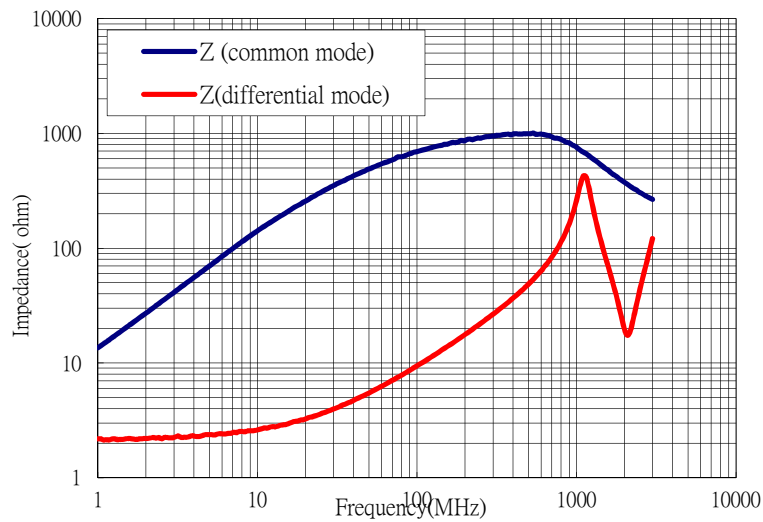

PRODUCT SPECIFICATION

SPEC. NO.

T-0602-141E



4-3 Test Equipment

4-3-1 Impedance

Measured by using Agilent E4991A RF Impedance Analyzer.

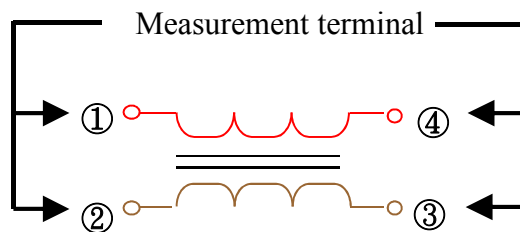

4-3-2 DC Resistance

Measured by using Chroma 16502 mill ohm meter.

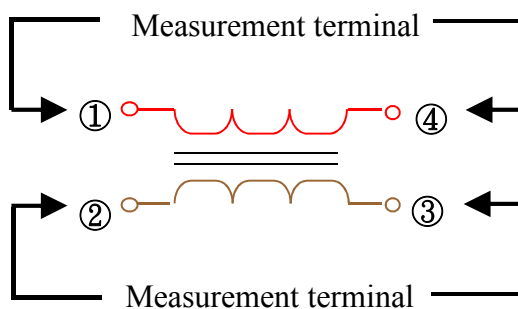

4-3-3 Insulation Resistance

Measured by using Chroma 19073

Measurement voltage : 50v, Measurement time: 60 sec.

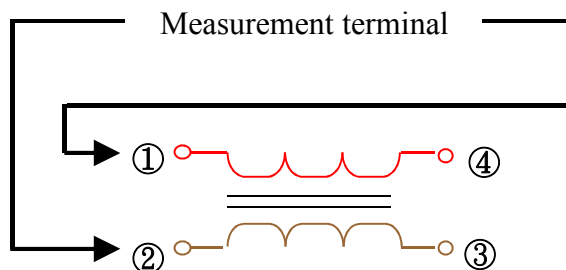

PRODUCT SPECIFICATION

SPEC. NO.

T-0602-141E

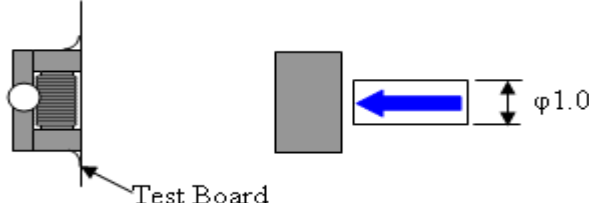
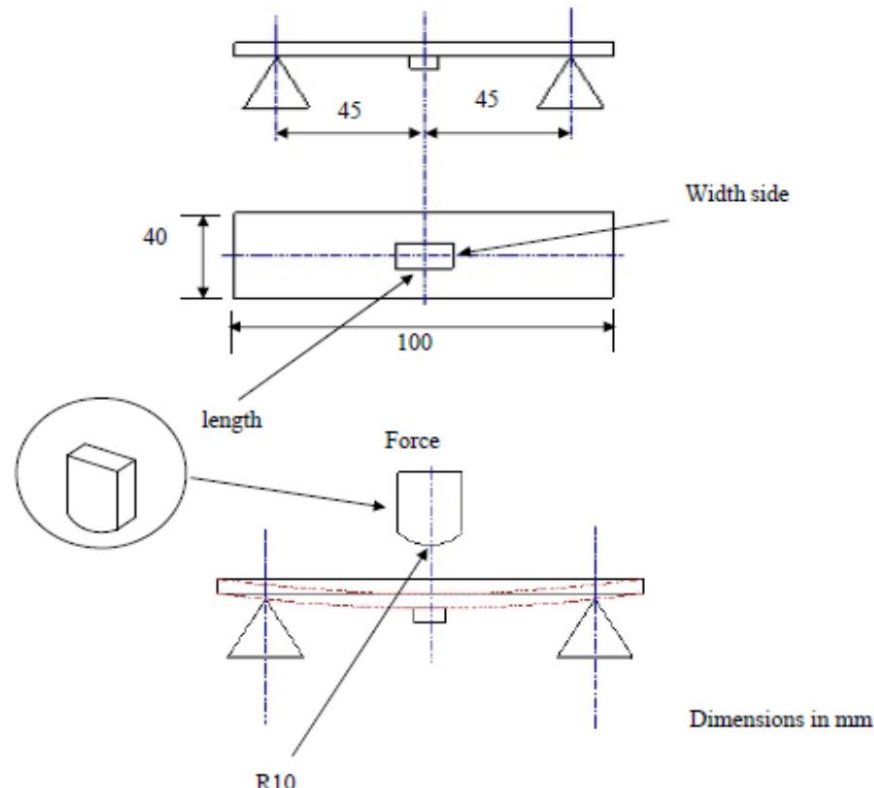

5. Reliability Test

Operating temperature : -40 to +125°C		Storage temp and humidity : -40 to 85°C, 70%RH max.
Item	Specifications	Test conditions
Solder-ability	It can be connected on the Recommendation soldering condition.	Apply cream solder to the test circuit board . It is mounted on the recommendation soldering condition.
Terminal strength	The terminal electrode and the ferrite must not be dam 160±25%	Solder a chip to test substrate, and then laterally apply a load 1.8Kg in the arrow direction. 
Strength on pc board bending	The terminal electrode and the ferrite must not be damaged.	Soldering a chip to a test substrate , bend the substrate by 2mm and then return.  <p>Dimensions in mm</p> <p>Test board : Glass base epoxy multiplayer board pc board pattern. PC board pattern : Recommended PC board pattern.</p>

PRODUCT SPECIFICATION

SPEC. NO.

T-0602-141E

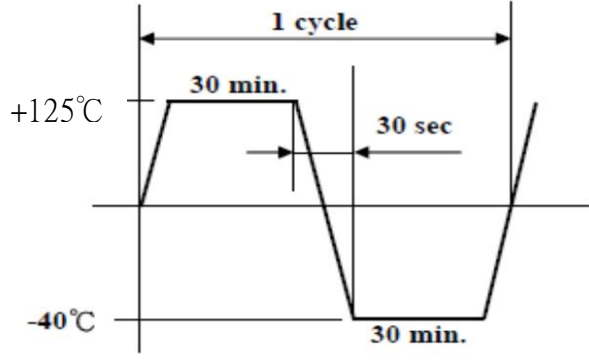

Item	Specifications	Test conditions
High temperature resistance	Appearance : Ferrite shall not be damaged. Impedance: Within $\pm 20\%$ of the initial value. insulation resistance: $>10(M\Omega)$ DC resistance : standard value	Temperature : $+125\pm 2^{\circ}\text{C}$ Applied voltage : Rated voltage Applied current : Rated current Testing time : 500 ± 12 hours Measurement : After placing for 24 hours min.
Humidity resistance	inside.	Temperature : $+85\pm 2^{\circ}\text{C}$ Humidity : 90 to 95%RH Applied current : Rated current Applied voltage : Rated voltage Testing time : 500 ± 12 hours Measurement : After placing for 24 hours min.
Thermal cycle		Temperature : $-40^{\circ}\text{C}, +125^{\circ}\text{C}$ kept stabilized for 30 minutes each. Cycle : 100 cycle Measurement : After placing for 24 hours min. 
Low temperature resistance		Temperature : $-40\pm 2^{\circ}\text{C}$ Testing time : 500 ± 12 hours Measurement : After placing for 24 hours min.
Vibration	Appearance : Ferrite shall not be damaged.	Frequency : 10 to 50 Hz Amplitude : 1.52 mm Dimension and times : X ,Y and Z directions for 2 hours each.

PRODUCT SPECIFICATION

SPEC. NO.

T-0602-141E



6. Packaging

The packaging must be done not to receive any damage during transporting and storing

6-1 Tape dimensions

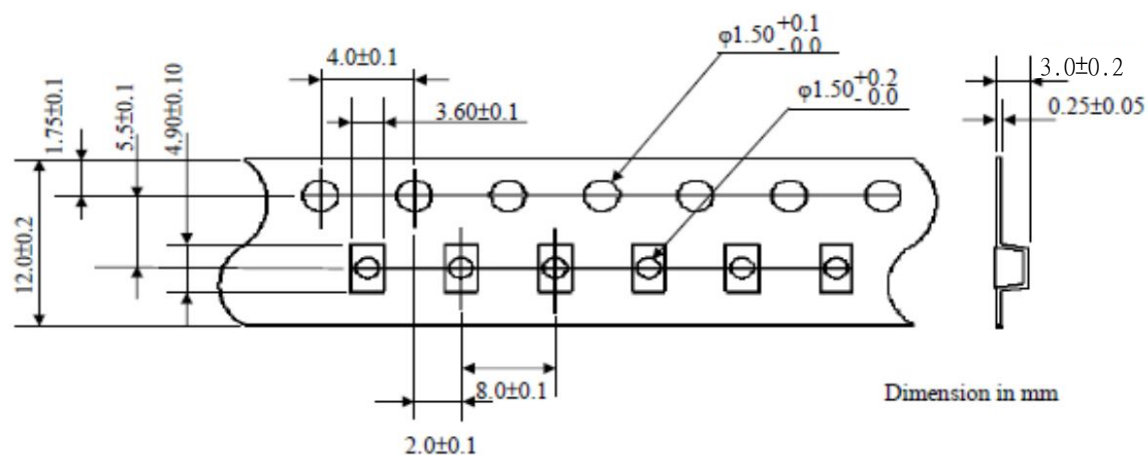

6-2 Reel dimensions

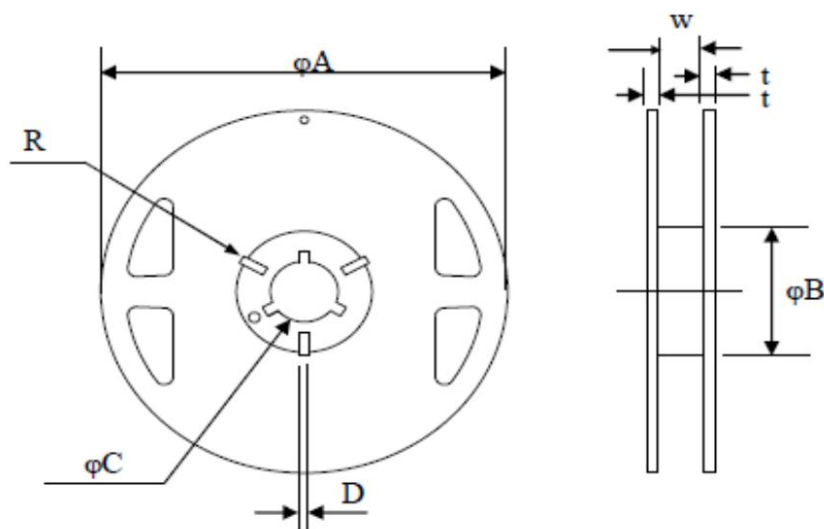

(Dimensions in mm)

Symbol	T
ϕA	180+0,-3
ϕB	60+1, -0
ϕC	13±0.2
D	2.2±0.5
W	12.0±0.3
t	1.2
R	1

6-3 Tapping figure

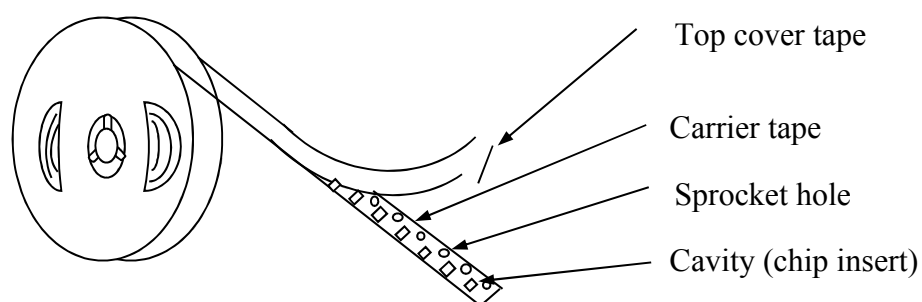

PRODUCT SPECIFICATION

SPEC. NO.

T-0602-141E



6-4 Packaging Form

There shall not continuation more than two vacancies of the product.

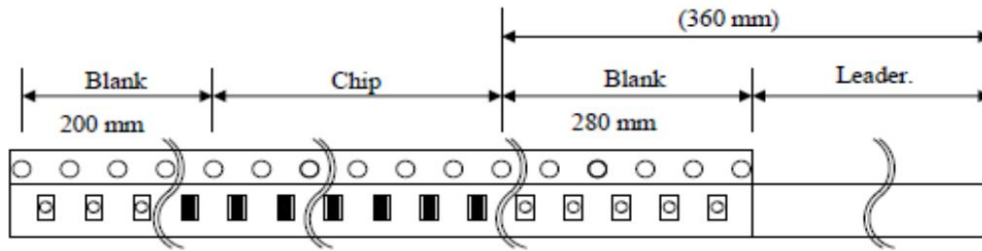

Material of carrier tape : Polystyrene

Material of cover tape : Polyester

6-5 Cover Tape Peel Strength

The force for tearing off cover tape is 0.05~0.69(N) in the arrow direction at the following conditions:

Temperature : 5 ~ 35°C

Humidity : 45 ~ 85%

Atmospheric pressure : 860 ~ 1060 hpa

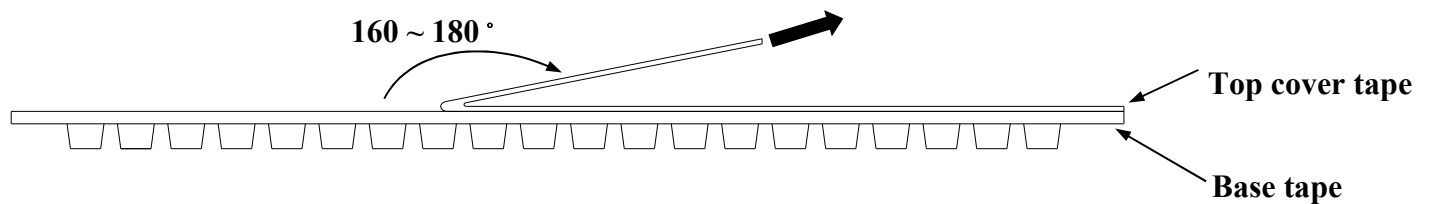

6-6 Packing Quantity

φ180 mm reel T type : 500 pcs./reel

PRODUCT SPECIFICATION

SPEC. NO.

T-0602-141E



7. Recommended Soldering Conditions (Please use this product by reflow soldering)

7-1 Recommended Footprint

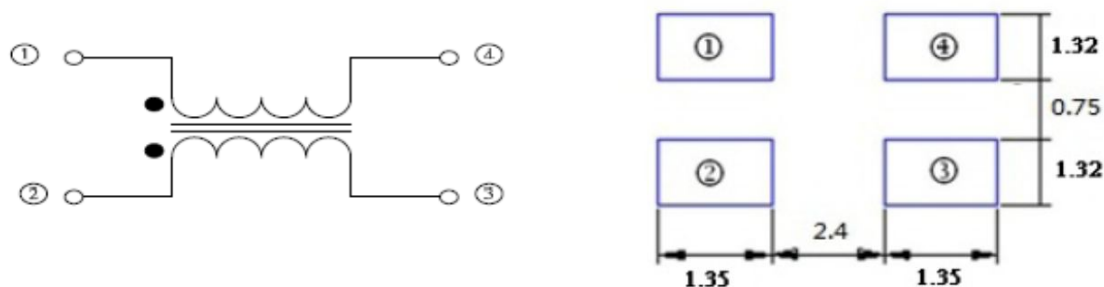

7-2 Recommended Reflow Pattern

Reflow: until two times

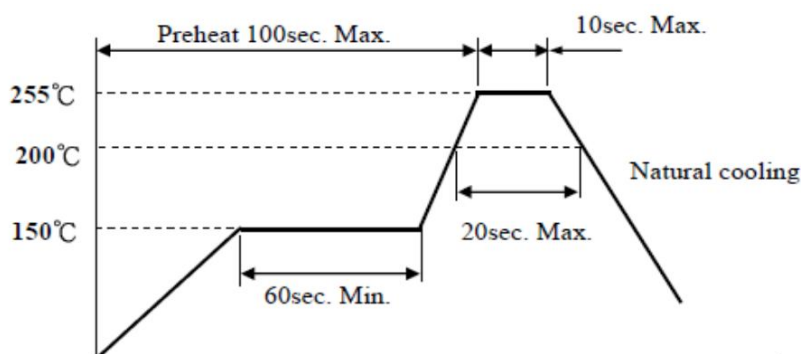

7-3 Iron Soldering

Use a solder iron of less than 30W when soldering, do not allow the soldering iron tip directly touch the ferrite body outside fo terminal electrode.

2 seconds max. at 280°C.

8. Attention in Case of Using

In case of using product, please avoid following matters:

- Splashing water or salt water
- Dew condenses
- Toxic gas (Hydrogen sulfide, Sulfurous acid, Chlorine, Ammonia)
- Vibrations or shocks which exceed the specified condition

Please be careful for the stress to this product by board flexure or something after the mounting.

*Recommended wire wound inductors should be used within 6 months from the time of delivery.

X-ON Electronics

Largest Supplier of Electrical and Electronic Components

Click to view similar products for [Common Mode Chokes / Filters](#) category:

Click to view products by [EMTEK](#) manufacturer:

Other Similar products are found below :

[RGCMF1210900H3T](#) [B82722A2102N001](#) [UAL21V07012500](#) [UAL24VR06500CH](#) [UALSC0220G0000](#) [UALSC058000000](#)
[UALSC0580J0000](#) [UALSC1520JH000](#) [UALSU10VR15019](#) [UALSU10VR20010](#) [UALSU16VD30030](#) [UALSU16VD40010](#)
[UALSU9H0305000](#) [UALSU9HF030600](#) [UALSU9HF060300](#) [UALSU9HR050340](#) [UALSU9VD070100](#) [UALSU9VR070170](#) [5701610000](#)
[CM7060M132R-10](#) [UALW21HS200290](#) [UALW21HS072450](#) [UALSU9VD070400](#) [UALSU9V0701000](#) [UALSU9HR030900](#)
[UALSU9HF050500](#) [UALSU9H0701000](#) [UALSU9H0208000](#) [UALSU9H0110000](#) [UALSCF25081300](#) [UALSC0305GS000](#)
[UALSC0120G0000](#) [UAL24VK06450CH](#) [UAL11VL1105000](#) [RN112-3.6-02-0M4](#) [RN114-1.2-02-10M](#) [RN122-0.6-02-47M](#) [RN122-3-02-4M5](#)
[RN142-1-02-33M](#) [RN214-2.5-02-3M3](#) [RN112-2-02-1M0](#) [RN143-6-02-1M8](#) [RN214-0.8-02-27M](#) [RN242-1.4-02-27M](#) [EXC-X4CH120X](#)
[DLW5BTM102TQ2L](#) [CMF16-153131](#) [CMF23H-273141](#) [744252510](#) [B82793C0253N201](#)