

REV.	MODIFICATION.	DATE	DRN
01	NEW DRAWING	08/12/05	NJB
02	ECN2007-059	05/04/07	SF
03	ECN2007-085	08/12/05	SF
04	CO2010835	02/10/09	MT
05	CO2010981	31/08/10	SF
06	CO2010985	01/10/10	SF
07	CO2011050	27/01/11	SF
08	CO2011253	27/01/11	SF

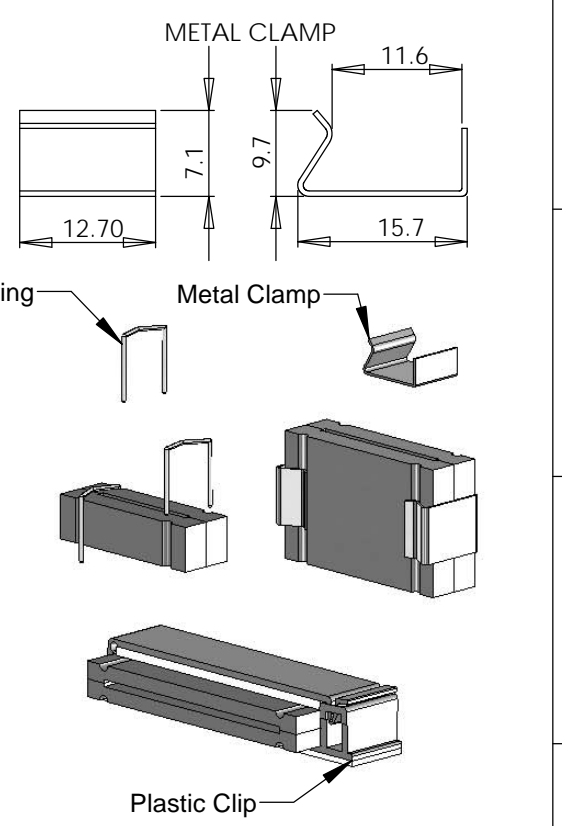

Ferrite Material: A5 RMS 303 • Casing Material: Nylon 6/6, RMS-244 • Metal Clamp & Spring: RMS-305

RFP	Fig	Metal Clip or Spring	A	B	C	D	E	IMPEDANCE		Standard Pack(Pieces)
								25MHz	100MHz	
RFP2-10-10-A5	2	N/A	16.5	2	10.25	12.5	0.6	27	69	240
RFP3-16-12-A5	2		25	2.8	12	21	1.1	28	90	144
RFP2-18-15-A5	3		28.5	2.25	15	23.5	0.42	36	99	385
RFP2-20-12-A5	2		32	2.1	12	27	0.4	30	87	315
RFP2-25-12-A5	2	37.1	3.3	12.7	32	0.9	36	106	66	
RFP1-20-10-A5	1	SPRING	38	6.35	10	26.6	0.8	45	107	60
RFP1-20-25-A5	1	METAL CLIP	38	6.35	25.4	26.6	0.8	105	175	15
RFP3-27-12-A5	3	N/A	40	2	10	34.4	0.8	43	110	60
RFP2-27-12-A5	2		3.25	12	35	0.55	16	73	72	
RFP1-26-10-M-A5	1	SPRING	45	6.35	10	34.4	0.8	102	189	15
RFP1-26-28-A5	1	METAL CLIP	45	6.35	28.5	34.4	0.8	15	50	162
RFP2-34-5-A5	3	N/A	49.6	3.25	5	44	0.55	23	70	72
RFP2-34-12-A5	3		12	44	0.55	23	70	72		
RFP1-34-10-A5	1	SPRING	55.1	6.35	10	43.7	0.8	36	104	40
RFP1-34-28-A5		METAL CLIP	55.1		28.5	43.7	0.8	80	181	10
RFP1-40-13-A5		SPRING	55.1		13	43.7	1.1	45	114	20
RFP1-40-15-A5		SPRING	55.1		15	43.7	0.8	50	124	10
RFP1-40-28-M-A5	1	METAL CLIP	63.5	6.35	15	52	0.8	77	172	16
RFP4-40-28-MPA5	4	PLASTIC WITH ADHESIVE BASE	63.5	12.7	28.5	52	1.6	77	172	16
RFP1-50-28-A5	1	METAL CLIP	76.2	6.35	28.5	65.3	0.85	70	200	10

Standard Pack Sizes may vary

- NOTES.
- See drawing 05-135 sheets 2 & 3 of 3 for Impedance graphs. Impedance figures are typical values.
  - Packaging information is only a guide & subject to variation.

INFORMATION CONTAINED IN THIS DOCUMENT IS CONFIDENTIAL TO RICHCO INTERNATIONAL Co. Ltd. AND MAY NOT BE DISCLOSED OR REPRODUCED IN WHOLE OR PART WITHOUT THEIR WRITTEN CONSENT.			
<b>RICHCO, INC.</b> WWW.RICHCO-INC.COM		ALL DIMENSIONS IN mm GENERAL TOLERANCES ±0.25 UNLESS OTHERWISE STATED 1 DECIMAL PLACE ± 2 DECIMAL PLACES ± ANGULAR ±1°	THIRD ANGLE
MATERIAL: See Table		COLOUR: See Table	
DESCRIPTION: RFP Ribbon Cable Split Cores		PART No: See Table	
DRG No: 05-135	NPR No:	SHEET SIZE A3	
DRN NJB	DATE 08/12/05	CHKD RC	DATE 08/12/05
SCALE NTS		SHEET No. 1 OF 3	

REV.	MODIFICATION.	DATE	DRN
01	NEW DRAWING	08/12/05	NJB
02	ECN2007-059	05/04/07	SF
03	ECN2007-085	08/12/05	SF
04	CO2010835	02/10/09	MT
05	CO2010981	31/08/10	SF
06	CO2010985	01/10/10	SF
07	CO2011050	27/01/11	SF
08	CO2011253	13/04/12	SF

RFP2-10-10-A5

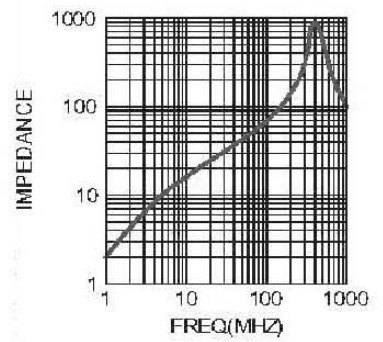

RFP3-16-12-A5

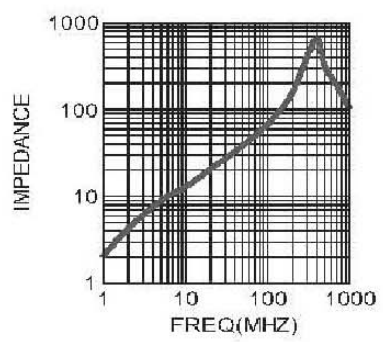

RFP2-18-15-A5

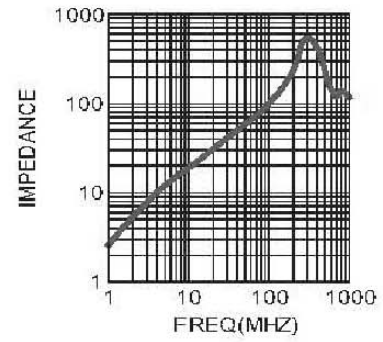

RFP2-20-12-A5

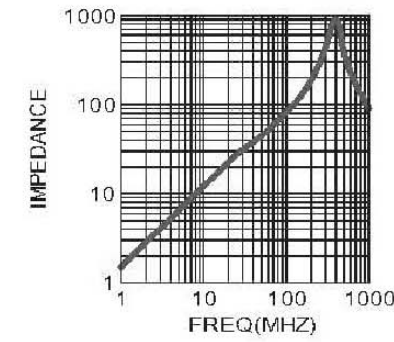

RFP2-25-12-A5

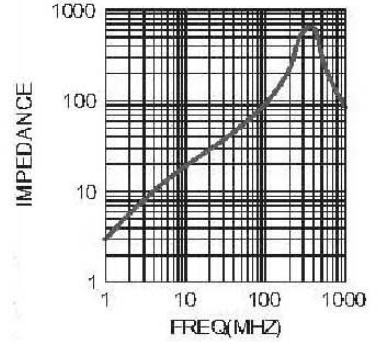

RFP1-20-10-A5

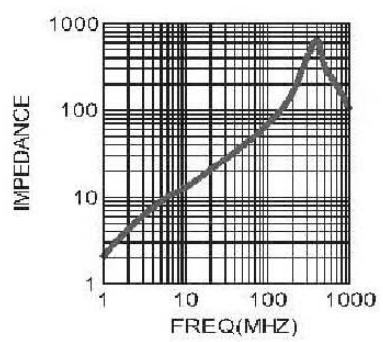

RFP1-20-25-A5

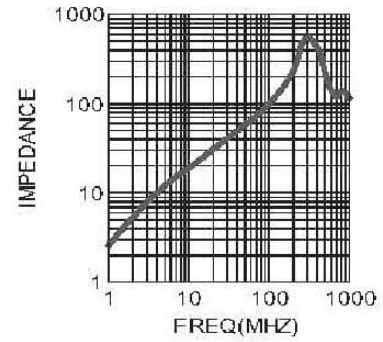

RFP3-27-12-A5

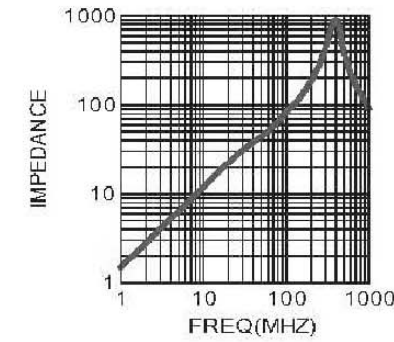

NOTES.  
1) Impedance figures are typical values.

INFORMATION CONTAINED IN THIS DOCUMENT IS CONFIDENTIAL TO RICHCO INTERNATIONAL Co. Ltd. AND MAY NOT BE DISCLOSED OR REPRODUCED IN WHOLE OR PART WITHOUT THEIR WRITTEN CONSENT.

<b>RICHCO, INC.</b> WWW.RICHCO-INC.COM		THIRD ANGLE 
---	--	-----------------

DESCRIPTION:  
RFP Ribbon Cable Split Cores, Impedance Graphs.

DRG No: 05-135 SHEET SIZE A3

DRN	DATE	CHKD	DATE	SCALE	SHEET No.
NJB	08/12/05	RC	08/12/05	NTS	2 OF 3

REV.	MODIFICATION.	DATE	DRN
01	NEW DRAWING	08/12/05	NJB
02	ECN2007-059	05/04/07	SF
03	ECN2007-085	08/12/05	SF
04	CO2010835	02/10/09	MT
05	CO2010981	31/08/10	SF
06	CO2010985	01/10/10	SF
07	CO2011050	27/01/11	SF
08	CO2011253	13/04/12	SF

RFP2-27-12-A5

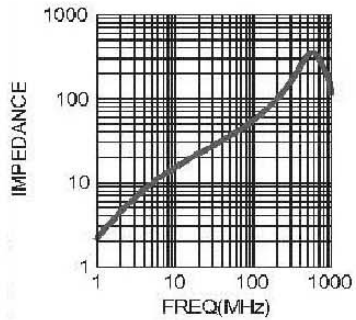

RFP1-26-10-M-A5

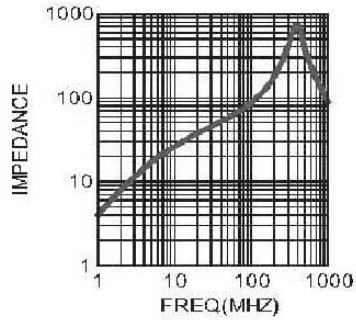

RFP1-26-28-A5

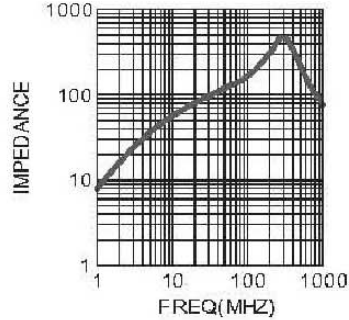

RFP2-34-5-A5

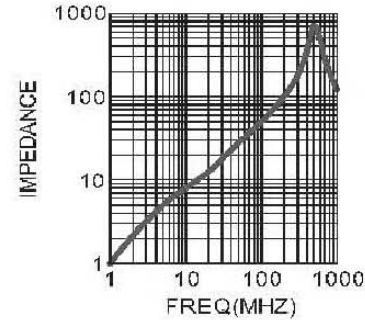

RFP2-34-12-A5

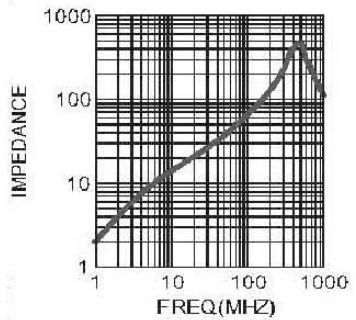

RFP1-34-10-A5

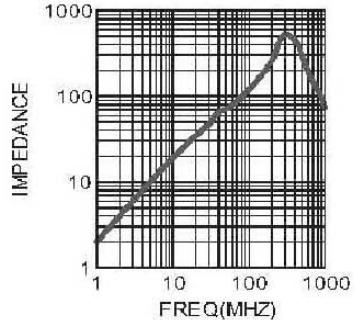

RFP1-34-28-A5

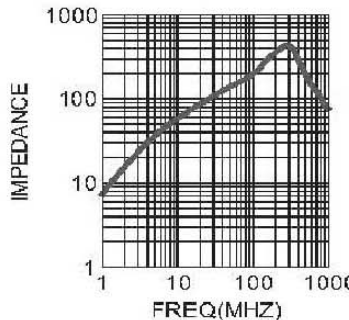

RFP1-40-13-A5

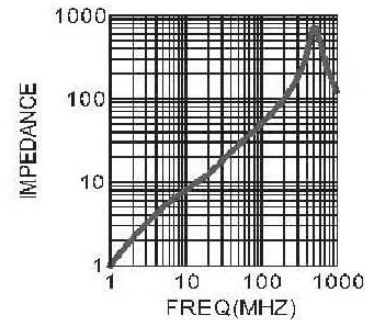

RFP1-40-15-A5

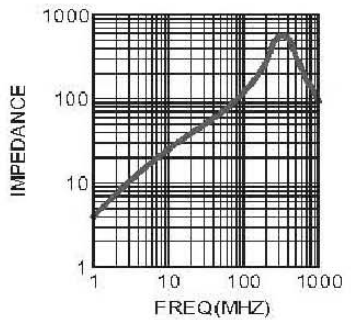

RFP1-40-28-M-A5

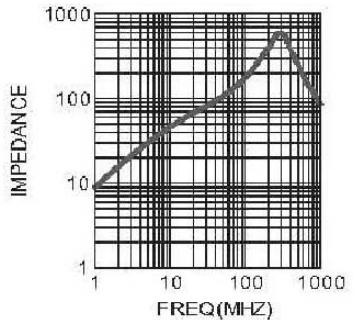

RFP4-40-28-MP-A5

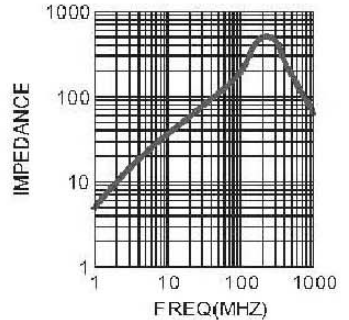

RFP1-50-28-A5

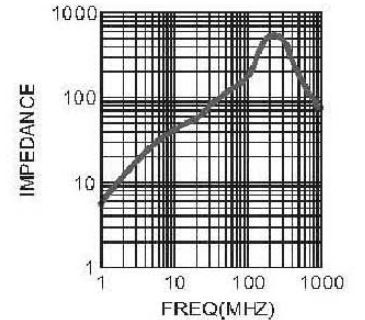

NOTES.  
1) Impedance figures are typical values.

INFORMATION CONTAINED IN THIS DOCUMENT IS CONFIDENTIAL TO RICHCO INTERNATIONAL Co. Ltd. AND MAY NOT BE DISCLOSED OR REPRODUCED IN WHOLE OR PART WITHOUT THEIR WRITTEN CONSENT.

**RICHCO, INC.**  
WWW.RICHCO-INC.COM



DESCRIPTION:  
RFP Ribbon Cable Split Cores, Impedance Graphs.

DRG No: 05-135		SHEET SIZE A3	
DRN NJB	DATE 08/12/05	CHKD RC	DATE 08/12/05
SCALE NTS	SHEET No. 3 OF 3		

## X-ON Electronics

Largest Supplier of Electrical and Electronic Components

*Click to view similar products for [Ferrite Cable Cores](#) category:*

*Click to view products by [Richco](#) manufacturer:*

Other Similar products are found below :

[2643626102](#) [FX28R0984-0](#) [FX28R0984-2](#) [AB 3X2X3SM](#) [2643164251](#) [2643665709](#) [2661626402](#) [LB 2.8X4.5U](#) [28R1127](#) [28R1260](#)  
[28R1575](#) [SM28R0760](#) [SM28R1531](#) [2631006302](#) [2643165451](#) [2643178351](#) [28R0760](#) [MS 21X14X4.5 W](#) [SM28B1101](#) [SS7X4X3W](#) [4327](#)  
[030 16141](#) [ASSE017-2](#) [2643103102](#) [2643164151](#) [2943666671](#) [4327 030 12611](#) [2643163851](#) [AB4X2X6SM](#) [432703013631](#) [LB4X2X8U](#)  
[28B1101](#) [28B0785](#) [SM28R1575](#) [SM28R1260](#) [74270051](#) [2643625902](#) [74278032](#) [2643480009](#) [2673069901](#) [HFB123049-300](#) [HFB143064-](#)  
[100](#) [HFB143064-300](#) [HFB170070-000](#) [ETD29/16/10-3C94](#) [ETD29-3F3](#) [ETD39-3C94](#) [RFP1-20-10-A5](#) [RFP1-40-28-M-A5](#) [RFP2-10-10-A5](#)  
[RFP2-25-12-A5](#)