

描述 / Descriptions

TO-220 塑封封装电压调整器。Voltage Regulator in a TO-220 Plastic Package.

特征 / Features

三端稳压调整器，输出电流高达 1.5A,内设过热保护和短路限制。

3-Terminal regulators ,output current up to 1.5A, internal thermal overload protection and short-circuit limiting.

用途 / Applications

电压调整器。

Voltage Regulator.

内部等效电路/应用电路 / Equivalent Circuit or Application Circuit

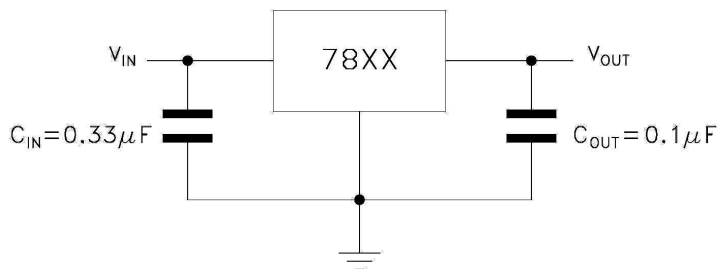

引脚排列 / Pinning

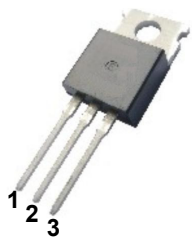

PIN 1 : IN

PIN 2 : GND

PIN 3 : OUT

印章代码 / Marking

见印章说明。See Marking Instructions

极限参数 / Absolute Maximum Ratings(Ta=25°C)

参数 Parameter	符号 Symbol	数值 Rating	单位 Unit
Input voltage	V_i	35	V
Thermal Resistance Junction-ambient	$R_{\theta JA}$	62.5	°C/W
Thermal Resistance Junction-case	$R_{\theta JC}$	5.0	°C/W
Junction Temperature	T_J	150	°C
Operating Junction Temperature Range	T_{OPR}	0~125	°C
Storage temperature range	T_{stg}	-65~150	°C

电性能参数 / Electrical Characteristics(Ta=25°C , $V_i=10V, I_o=500mA$, unless otherwise specified)

参数 Parameter	符号 Symbol	测试条件 Test Conditions	最小值 Min	典型值 Typ	最大值 Max	单位 Unit
Output Voltage	V_o	$T_j=25^\circ C$	4.8	5.0	5.2	V
		$V_i=7V-20V$ $I_o=5mA-1A$ $P_o \leq 15W$	4.75	5.0	5.25	V
Load Regulation	ΔV_{Load}	$T_j=25^\circ C$ $I_o=5mA-1.5A$			100	mV
		$T_j=25^\circ C$ $I_o=250mA-750mA$			50	mV
Line Regulation	ΔV_{Line}	$T_j=25^\circ C$ $V_i=7V-25V$		3.0	100	mV
		$T_j=25^\circ C$ $V_i=8V-12V$		1.0	50	mV
Quiescent Current	I_q	$T_j=25^\circ C$			8.0	mA
Quiescent Current Change	ΔI_q	$V_i=7V-25V$			0.8	mA
		$I_o=5mA-1A$			0.5	mA
Output Voltage Drift	$\Delta V_o / \Delta T$	$I_o=5mA$		-1.1		mV/°C
Output Noise Voltage	eN	B=10Hz-100KHz $T_j=25^\circ C$			40	$\mu V/V_o$
Supply Voltage Rejection	SVR	$V_i=8V-18V$ $f=120Hz$	62			dB
Dropout Voltage	V_d	$I_o=1A$ $T_j=25^\circ C$		2.0		V
Output Resistance	R_o	$f=1KHz$		17		m Ω
Short Circuit Current	I_{sc}	$V_i=35V$ $T_j=25^\circ C$		0.75		A
Short Circuit Peak Current	I_{scp}	$T_j=25^\circ C$		2.2		A

电参数曲线图 / Electrical Characteristic Curve

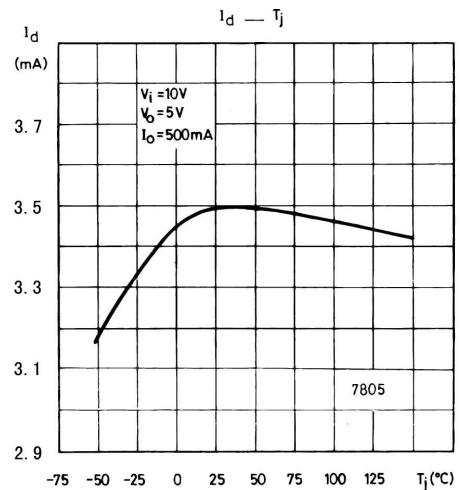
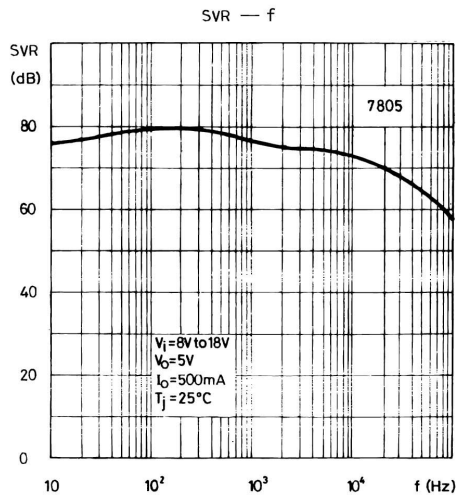
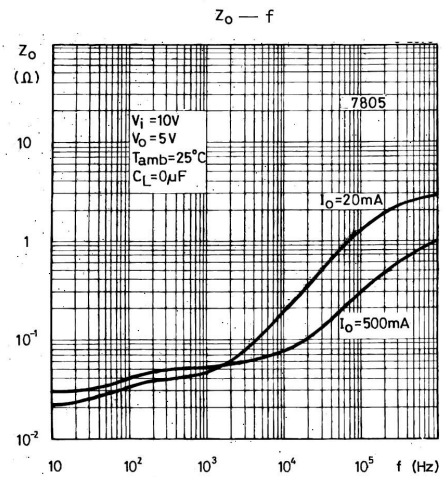
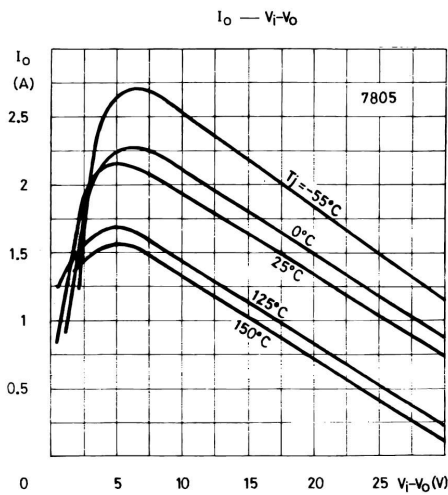
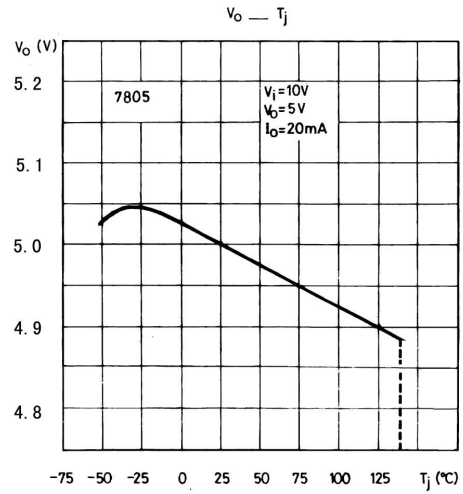
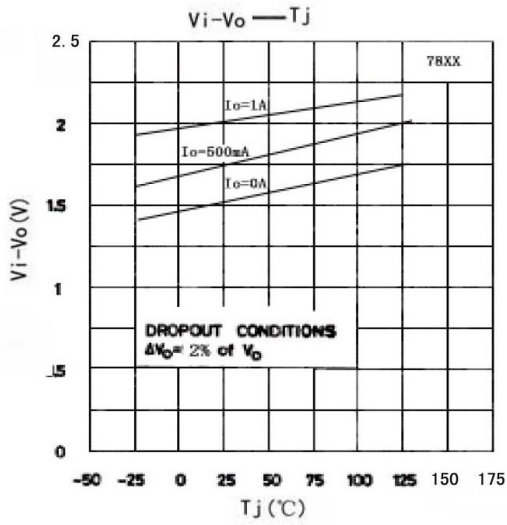

外形尺寸图 / Package Dimensions

TO-220

单位: mm

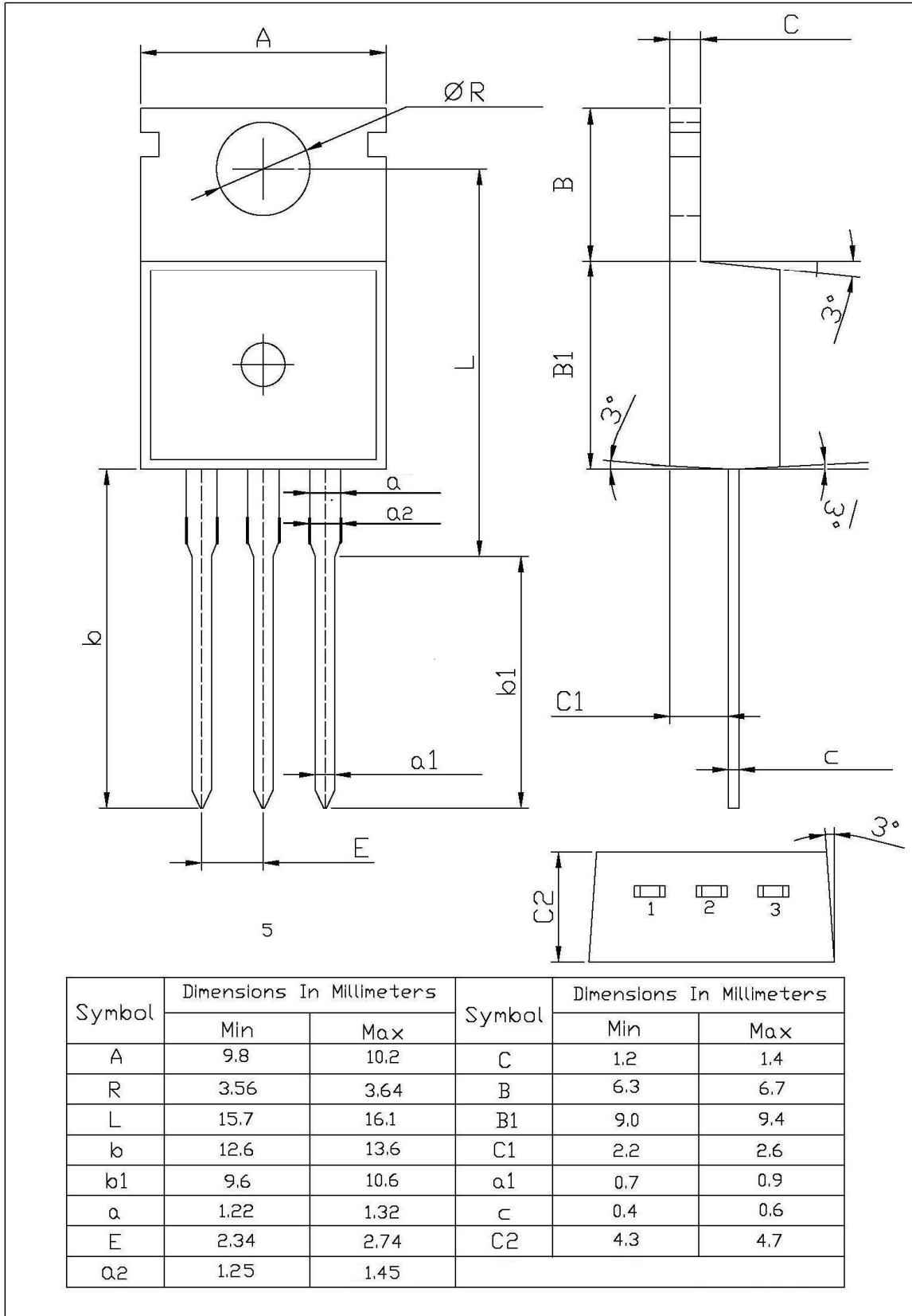

印章说明 / Marking Instructions

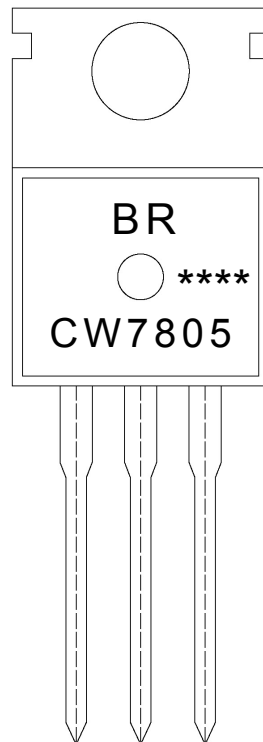

说明：

BR： 为公司代码

CW7805： 为型号代码

****： 为生产批号代码，随生产批号变化。

Note:

BR: Company Code.

CW7805: Product Type.

****: Lot No. Code, code change with Lot No.

波峰焊温度曲线图(无铅) / Temperature Profile for Dip Soldering(Pb-Free)

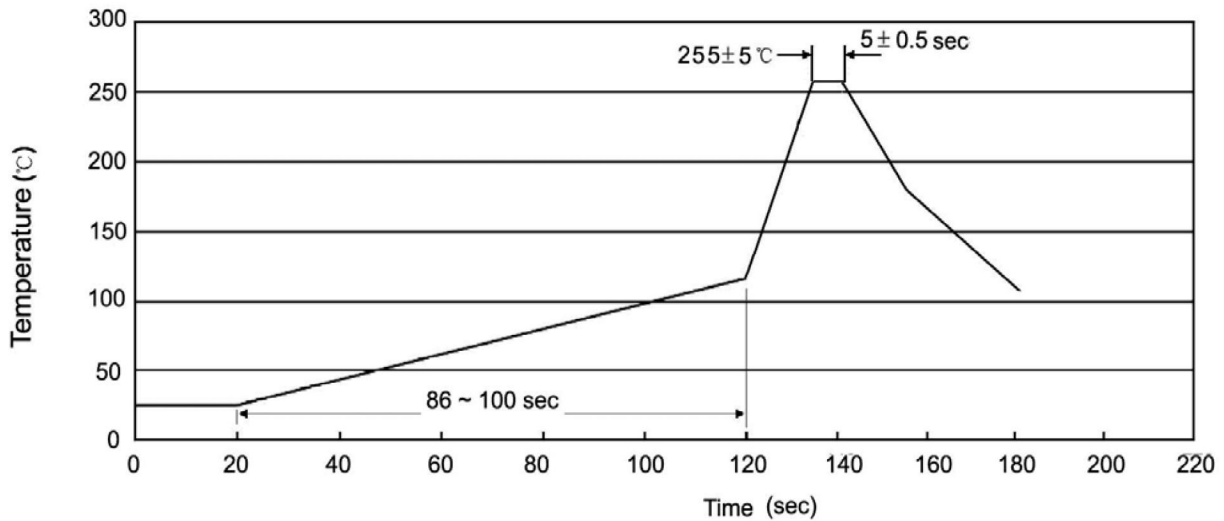

说明：

- 1、预热温度 25~150°C，时间 60~90sec;
- 2、峰值温度 255±5°C，时间持续为 5±0.5sec;
- 3、焊接制程冷却速度为 2~10°C/sec.

Note:

- 1.Preheating:25~150°C, Time:60~90sec.
- 2.Peak Temp.:255±5°C, Duration:5±0.5sec.
3. Cooling Speed: 2~10°C/sec.

耐焊接热试验条件 / Resistance to Soldering Heat Test Conditions

温度：270±5°C 时间：10±1 sec. Temp:270±5°C Time:10±1 sec

包装规格 / Packaging SPEC.

散件包装 / BULK

Package Type 封装形式	Units 包装数量					Dimension 包装尺寸 (unit: mm3)		
	Units/Bag 只/袋	Bags/Inner Box 袋/盒	Units/Inner Box 只/盒	Inner Boxes/Outer Box 盒/箱	Units/Outer Box 只/箱	Bag 袋	Inner Box 盒	Outer Box 箱
TO-220/F	200	10	2,000	5	10,000	135×190	237×172×102	560×245×195

套管包装 / TUBE

Package Type 封装形式	Units 包装数量					Dimension 包装尺寸 (unit: mm3)		
	Units/Tube 只/套管	Tubes/Inner Box 套管/盒	Units/Inner Box 只/盒	Inner Boxes/Outer Box 盒/箱	Units/Outer Box 只/箱	Tube 套管	Inner Box 盒	Outer Box 箱
TO-220/F	50	20	1,000	5	5,000	532×31.4×5.5	555×164×50	575×290×180

使用说明 / Notices

X-ON Electronics

Largest Supplier of Electrical and Electronic Components

Click to view similar products for [Linear Voltage Regulators](#) category:

Click to view products by [Blue Rocket](#) manufacturer:

Other Similar products are found below :

[LV56831P-E](#) [LV5684PVD-XH](#) [MAX202ECWE-LF](#) [MCDTSA6-2R](#) [L4953G](#) [L7815ACV-DG](#) [PQ3DZ53U](#) [LV56801P-E](#)
[TCR3DF13,LM\(CT](#) [TCR3DF39,LM\(CT](#) [TLE42794G](#) [L78L05CZ/1SX](#) [L78LR05DL-MA-E](#) [L78MR05-E](#) [033150D](#) [033151B](#) [090756R](#)
[636416C](#) [NCV78M15BDTG](#) [702482B](#) [714954EB](#) [TLE42794GM](#) [TLE42994GM](#) [ZMR500QFTA](#) [BA033LBSG2-TR](#)
[NCV78M05ABDTRKG](#) [NCV78M08BDTRKG](#) [NCP7808TG](#) [NCV571SN12T1G](#) [LV5680P-E](#) [CAJ24C256YI-GT3](#) [L78M15CV-DG](#) [L9474N](#)
[TLS202B1MBV33HTSA1](#) [L79M05T-E](#) [NCP571SN09T1G](#) [MAX15006AASA/V+](#) [MIC5283-5.0YML-T5](#) [L4969URTR-E](#) [L78LR05D-MA-E](#)
[NCV7808BDTRKG](#) [L9466N](#) [NCP7805ETG](#) [SC7812CTG](#) [NCV7809BTG](#) [NCV571SN09T1G](#) [NCV317MBTG](#) [MC78M15CDTT5G](#)
[MC78M12CDTT5G](#) [L9468N](#)