



ISO9001 ISO14001 IATF16949 CHILISIN ELECTRONICS CORP.

RoHS & Halogen Free & REACH Compliance.

### SPECIFICATION FOR APPROVAL

Customer : 各廠家

Customer P/N: \_\_\_\_\_

Drawing No : \_\_\_\_\_

Quantity : 0 Pcs. Date : 2019/02/25

Chilisin P/N : MHCB06030-R22M-C1

SPECIFICATION ACCEPTED BY:	
COMPONENT ENGINEER	
ELECTRICAL ENGINEER	
MECHANICAL ENGINEER	
APPROVED	
REJECTED	

**奇力新電子股份有限公司**  
Chilisin Electronics Corp  
No. 29, Alley 301, Tehhsin Rd.,  
Hukou, Hsinchu 303, Taiwan  
TEL : +886-3- 599-2646  
FAX : +886-3- 599-9176  
E-mail : sales@chilisin.com  
http : //www.chilisin.com

**東莞奇力新電子(東莞廠)有限公司**  
Chilisin Electronics (Dongguan) Co., Ltd.  
No. 78, Puxing Rd., Yuliangwei Administration Area,  
Qingxi Town, Dongguan City, Guangdong, China  
TEL : +86-769-8773-0251~3  
FAX : +86-769-8773-0232  
E-mail : cect@chilisin.com

**奇力新電子(越南廠)有限公司**  
Chilisin Electronics (Vietnam) Limited  
No 143 - 145, Road No 10, VSIP Hai Phong,  
Lap Le Commune, Thuy Nguyen Dist,  
Haiphong City, Vietnam  
Tel : 84-316 255 688 Fax : 84-316 255  
689  
E-mail : sales@chilisin.com

**奇力新電子(湖南廠)有限公司**  
HuNan Chilisin Electronics Technology Co., Ltd  
No. 8, Shaziao Liangshuijing Town, Yuanling  
County, Huaihua City, Hunan Province 419601,  
China  
Tel : 86-745-867-5882  
E-mail : cect@chilisin.com

Drawn by  
鍾瑞民 jacky.chung

Checked by  
吳韋邑 wayne.wu

Approved by  
鍾瑞民 jacky.chung

# MHCB06030 Series Specification

**1 Scope:** This specification applies to large current and low loss SMD shielding power inductor.

**2 Part Numbering:**

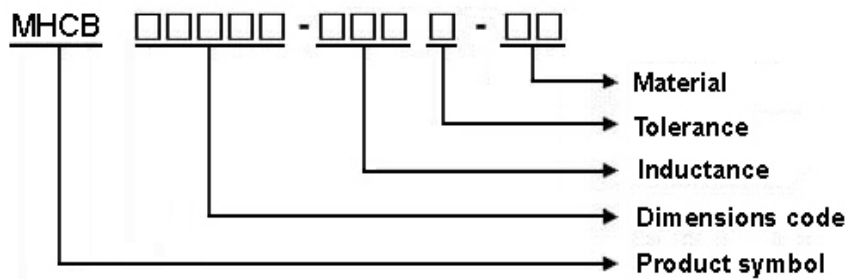

**3 Rating:**

Operating Temperature:  $-55^{\circ}\text{C} \sim 125^{\circ}\text{C}$  (Including self - temperature rise)

Storage Temperature: (on tape & reel):  $-20^{\circ}\text{C}$  to  $+40^{\circ}\text{C}$ ; 75% RH max.

**4 Marking:**

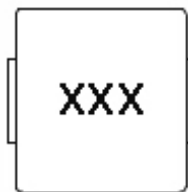

**Ex : MHCB06030-1R0M-C1**

**Marking : 1R0**

**Marking color : Black**

**5 Standard Testing Condition**

	Unless otherwise specified	In case of doubt
Temperature	Ordinary Temperature(15 to 35°C)	20 to 30°C
Humidity	Ordinary Humidity(25 to 85% RH)	50 to 80 %RH

## MHCB06030 Series Specification

### 6 Configuration and Dimensions:

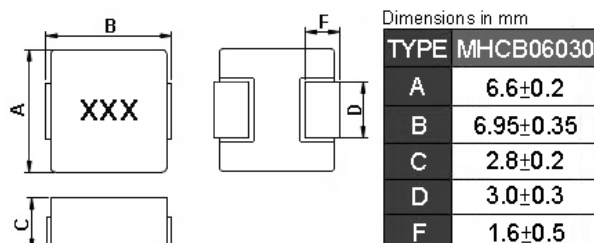

### 7 Electrical Characteristics:

Part No.	Inductance (uH)	Tolerance (±%)	Test Freq.	I <sub>rms</sub> (A) Typ.	I <sub>sat</sub> (A) Typ.	RDC(mΩ) Max.	Marking
MHCB06030-R10M-C1	0.1	20	100kHz,0.5V	32.5	60	1.7(1.5typ)	R10
MHCB06030-R22M-C1	0.22	20	100kHz,0.5V	23	40	2.8(2.5typ)	R22
MHCB06030-R33M-C1	0.33	20	100kHz,0.5V	20	30	3.9(3.5typ)	R33
MHCB06030-R47M-C1	0.47	20	100kHz,0.5V	17.5	26	4.2(4.0typ)	R47
MHCB06030-R68M-C1	0.68	20	100kHz,0.5V	15.5	25	5.5(5.0typ)	R68
MHCB06030-R82M-C1	0.82	20	100kHz,0.5V	13	24	8.0(6.7typ)	R82
MHCB06030-1R0M-C1	1	20	100kHz,0.5V	11	22	10(9.0typ)	1R0
MHCB06030-1R5M-C1	1.5	20	100kHz,0.5V	9	18	15(14typ)	1R5
MHCB06030-2R2M-C1	2.2	20	100kHz,0.5V	8	14	20(18typ)	2R2
MHCB06030-3R3M-C1	3.3	20	100kHz,0.5V	6	13.5	30(28typ)	3R3
MHCB06030-4R7M-C1	4.7	20	100kHz,0.5V	5.5	10	40(37typ)	4R7
MHCB06030-6R8M-C1	6.8	20	100kHz,0.5V	4.5	8	60(54typ)	6R8
MHCB06030-100M-C1	10	20	100kHz,0.5V	3	7	102(85typ)	100

**Note:**

1. Operating temperature range -55°C ~125°C (Including self - temperature rise)
2. I<sub>sat</sub> for Inductance drop 20% from its value without current.
3. I<sub>rms</sub> for a 40°C temperature rise from 25°C ambient.
4. The part temperature (ambient + temp rise) should not exceed 125°C under worst case operating conditions.  
Circuit design 125°C under worst case operating conditions. Component placement, PWB trace size and thickness, airflow and other cooling provisions all affect the part temperature. Part temperature should be verified in the end application.
5. Absolute maximum voltage 30VDC

## MHCB06030 Series Specification

### 8 MHCB06030 Series

#### 8.1 Construction:

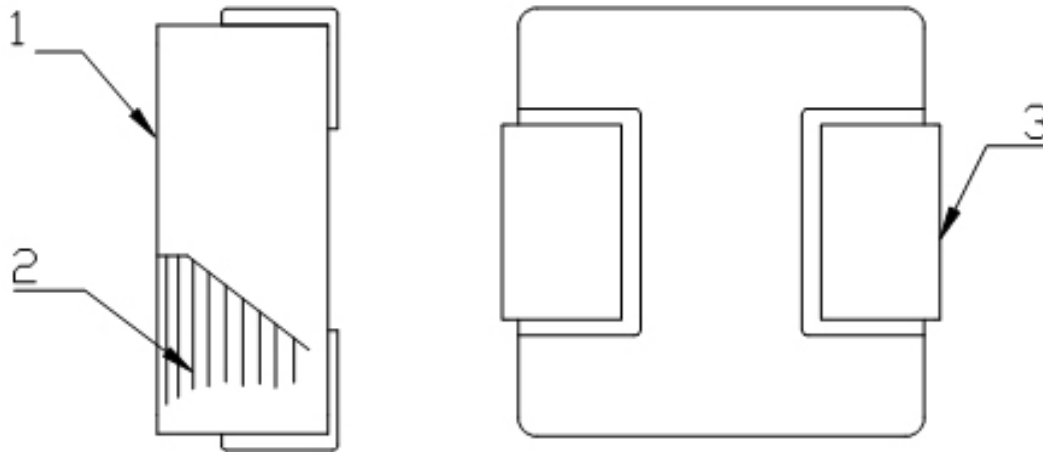

#### 8.2 Material List:

No	Part	Material
1	COATING+ CORE	CARBONYL IRON POWDERS
2	WIRE	COPPER WIRE
3	TERMINAL	TERMINAL COPPER

# MHCB06030 Series Specification

## 9 Packaging:

### 9.1 Packaging -Cover Tape

The force for tearing off cover tape is 10 to 130 grams in the arrow direction.



### 9.2 Packaging Quantity

TYPE	PCS/REEL
MHCB06030	1000

### 9.3 Reel Dimensions

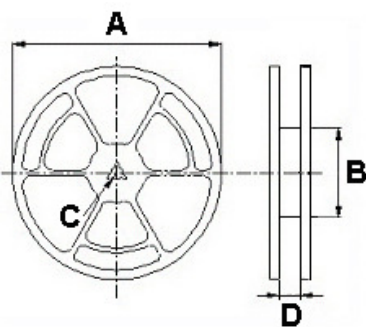

Dimensions in mm

TYPE	A	B	C	D
MHCB06030	330	100	13	16

## MHCB06030 Series Specification

### 9 Packaging:

#### 9.4 Tape Dimensions in mm

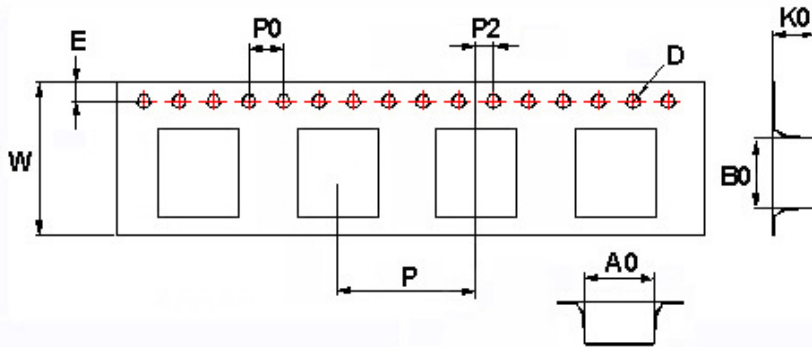

TYPE	A0	B0	K0	D	E	W	P	P0	P2
MHCB06030	6.9	7.6	3.4	1.55	1.75	16	12	4	2

### 10 Recommended Land Pattern:

PAD LAYOUT

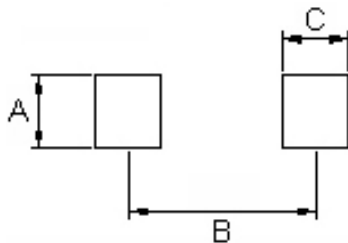

Dimensions in mm

TYPE	A(in/mm)	B(in/mm)	C(in/mm)
MHCB06030	0.138/3.5	0.238/6.05	0.093/2.35

### 11 Note:

1. Please make sure that your product has been evaluated and confirmed against your specifications when our product is mounted to your product.
2. Do not knock nor drop.
3. All the items and parameters in this product specification have been prescribed on the premise that our product is used for the purpose, under the condition and in the environment agreed upon between you and us. You are requested not to use our product deviating from such agreement.
4. Please keep the distance between transformer/coil and other components (refer to the standard IEC 950)
5. The moisture sensitivity level (MSL) of products is classified as level 1.



ISO9001 ISO14001 IATF16949 CHILISIN ELECTRONICS CORP.

# MHCB06030 Series Specification

12 Graph: MHCB06030-R22M-C1

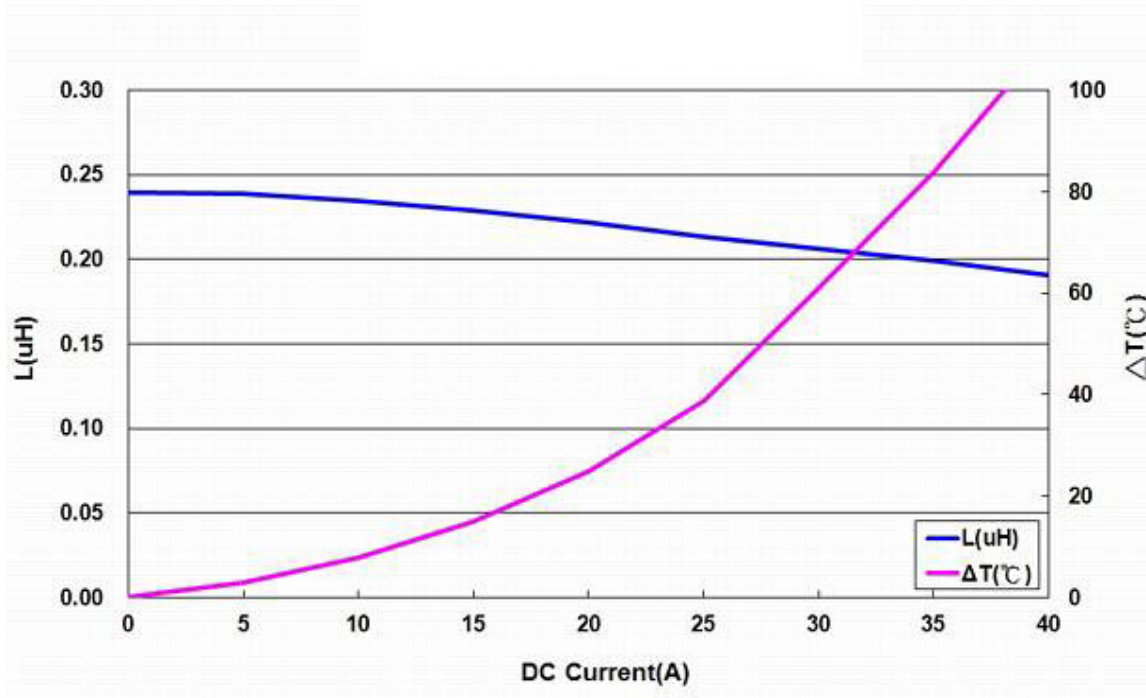

## X-ON Electronics

Largest Supplier of Electrical and Electronic Components

*Click to view similar products for [Fixed Inductors](#) category:*

*Click to view products by [Chilisin](#) manufacturer:*

Other Similar products are found below :

[MLZ1608M6R8WTD25](#) [MLZ1608N6R8LT000](#) [MLZ1608N3R3LTD25](#) [MLZ1608N3R3LT000](#) [MLZ1608N150LT000](#)

[MLZ1608M150WTD25](#) [MLZ1608M3R3WTD25](#) [MLZ1608M3R3WT000](#) [MLZ1608M150WT000](#) [MLZ1608A1R5WT000](#)

[MLZ1608N1R5LT000](#) [B82432C1333K000](#) [PCMB053T-1R0MS](#) [PCMB053T-1R5MS](#) [PCMB104T-1R5MS](#) [CR32NP-100KC](#) [CR32NP-](#)

[151KC](#) [CR32NP-180KC](#) [CR32NP-181KC](#) [CR32NP-1R5MC](#) [CR32NP-390KC](#) [CR32NP-3R9MC](#) [CR32NP-680KC](#) [CR32NP-820KC](#)

[CR32NP-8R2MC](#) [CR43NP-390KC](#) [CR43NP-560KC](#) [CR43NP-680KC](#) [CR54NP-181KC](#) [CR54NP-470LC](#) [CR54NP-820KC](#) [CR54NP-8R5MC](#)

[MGDQ4-00004-P](#) [MGDU1-00016-P](#) [MHL1ECTTP18NJ](#) [MHL1JCTTD12NJ](#) [PE-51506NL](#) [PE-53601NL](#) [PE-53630NL](#) [PE-53824SNLT](#) [PE-](#)

[62892NL](#) [PE-92100NL](#) [PG0434.801NLT](#) [PG0936.113NLT](#) [PM06-2N7](#) [PM06-39NJ](#) [HC2LP-R47-R](#) [HC2-R47-R](#) [HC3-2R2-R](#) [HC8-1R2-R](#)