



Form No.: QF-1274
Edition: 2

ISO9001 & ISO14001 & TS16949 **CHILISIN ELECTRONICS CORP.**

RoHS & Halogen Free & REACH Compliance.

SPECIFICATION FOR APPROVAL

Customer : _____ **各廠家**

Customer P/N: _____

Drawing No : _____

Quantity : 0 **Pcs.** **Date :** 2018/11/13

Chilisin P/N : LVC201B10-2R2M-N

SPECIFICATION	
ACCEPTED BY:	
COMPONENT ENGINEER	
ELECTRICAL ENGINEER	
MECHANICAL ENGINEER	
APPROVED	
REJECTED	

奇力新電子股份有限公司
Chilisin Electronics Corp
No. 29, Alley 301, Tehhsin Rd.,
Hukou, Hsinchu 303, Taiwan
TEL : +886-3- 599-2646
FAX : +886-3- 599-9176
E-mail : sales@chilisin.com.tw
http : //www.chilisin.com.tw

東莞奇力新電子有限公司
Chilisin Electronics (Dongguan) Co., Ltd.
No. 78, Puxing Rd., Yuliangwei Administration Area,
Qingxi Town, Dongguan City, Guangdong, China
TEL : +86-769-8773-0251~3
FAX : +86-769-8773-0232
E-mail : cect@chilisin.com.tw

奇力新電子(河南)有限公司
Chilisin Electronics (Henan) Co., Ltd.
XiuWu Xian, industry gathering area
JiaoZuo, Henan China
Postal Code:454350
TEL:+86-391-717-0682
FAX:+86-391-717-0666

蘇州奇益新電子有限公司
SUZHOU QI YIXIN Electronics Co., Ltd.
No.143, Song Shan Rd., Suzhou New District,
Suzhou, China
Postal Code:215129
TEL:+86-512-6841-2350
FAX:+86-512-6841-2356
E-mail : suzhou@chilisin.com.tw

Drawn by
陳瑞揚 ryan.chen

Checked by
溫美玲 ling

Approved by
陳瑞揚 ryan.chen

LVC201B10 Series Specification

1 Scope: This specification applies to Wire Wound Power Inductors

2 Part Numbering:

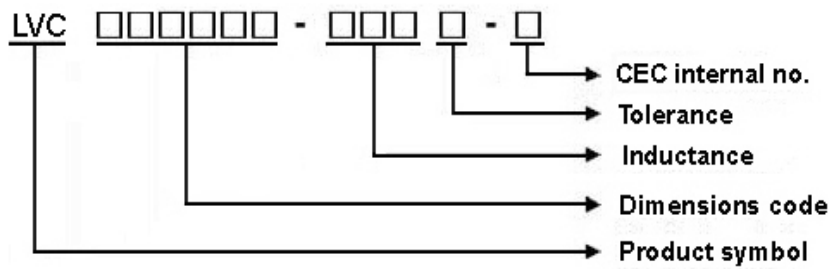

3 Rating:

Operating Temperature: $-55^{\circ}\text{C} \sim 125^{\circ}\text{C}$ (Including self - temperature rise)

Storage Temperature: $20^{\circ}\text{C} \sim 25^{\circ}\text{C}$ R.H. 65% (In Tape & Reel Condition)

4 Marking:

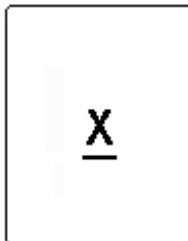

Ex : LVC201B10-1R0M-N

Marking : B

Marking color : Black

5 Standard Testing Condition

	Unless otherwise specified	In case of doubt
Temperature	Ordinary Temperature(15 to 35°C)	20 to 30°C
Humidity	Ordinary Humidity(25 to 85% RH)	50 to 80 %RH

LVC201B10 Series Specification

6 Configuration and Dimensions:

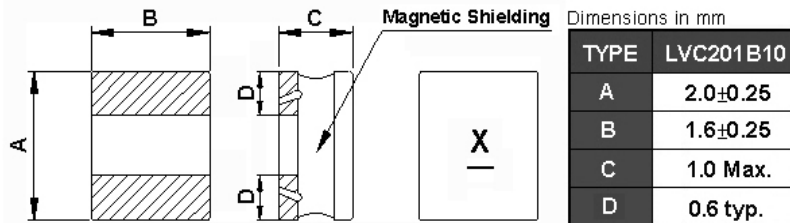

7 Electrical Characteristics:

Part No.	Inductance (uH)	Test Freq.	RDC (Ω)±30%	Isat(mA) Typ.(Max)	Irms(mA) Typ.(Max)	Tolerance (±%)	Marking
LVC201B10-R24□-N	0.24	1MHz,200mV	0.026	3200(2800)	3000(2700)	20,30	M
LVC201B10-1R0□-N	1	1MHz,200mV	0.095	1860(1670)	1860(1670)	20,30	B
LVC201B10-1R5□-N	1.5	1MHz,200mV	0.14	1640(1470)	1650(1480)	20,30	C
LVC201B10-2R2□-N	2.2	1MHz,200mV	0.19	1300(1170)	1300(1170)	20,30	D
LVC201B10-3R3□-N	3.3	1MHz,200mV	0.295	960(860)	980(880)	20,30	E
LVC201B10-4R7□-N	4.7	1MHz,200mV	0.36	840(750)	900(810)	20,30	F
LVC201B10-6R8□-N	6.8	1MHz,200mV	0.64	660(590)	700(630)	20,30	G
LVC201B10-100□-N	10	1MHz,200mV	1	540(480)	560(500)	20,30	H
LVC201B10-150□-N	15	1MHz,200mV	1.5	390(350)	420(370)	20,30	K
LVC201B10-180□-N	18	1MHz,200mV	1.6	390(350)	410(360)	20,30	J
LVC201B10-220□-N	22	1MHz,200mV	1.7	380(340)	400(360)	20,30	I

NOTE: □-tolerance M=±20% / T=±30%

1. Operating temperature range - 5 5 °C ~ 1 2 5 °C (Including self - temperature rise)

2. Isat for Inductance drop 30% from its value without current.

3. I rms for a 40°C temperature rise from 25°C ambient.

"-N" FOR COMPLETELY LEAD FREE TYPE(INCLUDING FERRITE BODY & SOLDER)

LVC201B10 Series Specification

8 LVC201B10 Series

8.1 Construction:

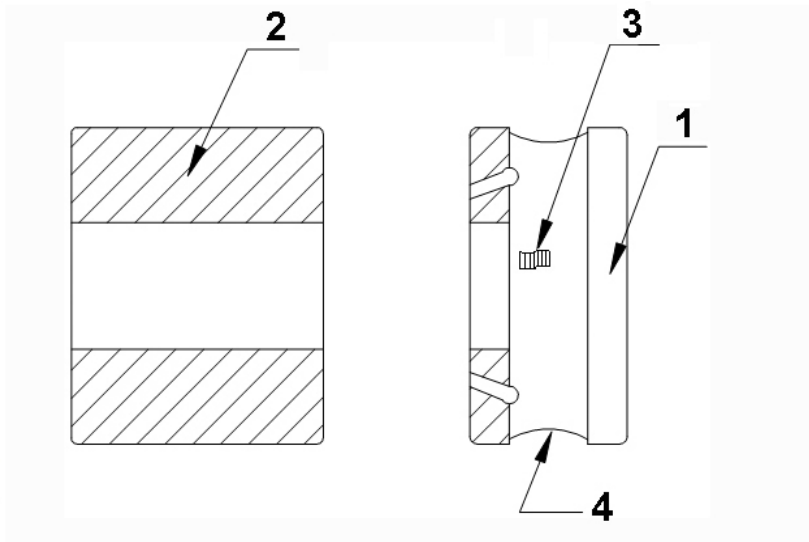

8.2 Material List:

No	Part	Material
1	CORE	FERRITE
2	TERMINAL	Ag/Cu/Ni/Sn
3	WIRE	Grade 180
4	EPOXY	Magnetic powder resin



LVC201B10 Series Specification

9 Reliability Of Wire Wound Power Inductors

1-1.Mechanical Performance

No	Item	Specification	Test Method
1-1-1	Vibration	Chip coil shall not be damaged after tested as test method	Oscillation Frequency:10Hz to 55 Hz to 10 Hz for 1 min Total Amplitude:1.5mm Testing Time:A period of 2 hours in each of 3 mutually perpendicular directions(Total 6 hours)
1-1-2	Solderability	The wetting area of the electrode shall be at least 95% covered with new solder coating	Solder:Sn/Ag3.0/Cu0.5 per-Heating:150°C±10°C/1min to 2min solder Temperature:245°C±5°C Immersion Time:4s±1s
1-1-3	Resistance to Soldering Heat	Appearance:No damage	Solder:Sn/Ag3.0/Cu0.5 per-Heating:150°C±10°C/1min to 2min solder Temperature:260°C±5°C Immersion Time:10s±1s

1-2.Environmental Performance

No	Item	Specification	Test Method														
1-2-1	Heat Resistance	Appearance: No damage Inductance Change:within±10%	Temperature:125°C±3°C Time:500h Then measured after exposure in the room Condition for 24h±2h														
1-2-2	Cold Resistance		Temperature: -55°C±3°C Time:500h Then measured after exposure in the room Condition for 24h±2h														
1-2-3	Humidity		Temperature: 40°C±2°C Humidity:90%(RH) to 95%(RH) Time:500h Then measures after exposure in the room Condition for 24h±2h														
1-2-4	Temperature Cycle		One cycle: <table border="1" style="width: 100%; border-collapse: collapse;"> <thead> <tr> <th>Step</th> <th>Temperature (°C)</th> <th>Time (min)</th> </tr> </thead> <tbody> <tr> <td>1</td> <td>-55±3</td> <td>30</td> </tr> <tr> <td>2</td> <td>25±2</td> <td>3</td> </tr> <tr> <td>3</td> <td>125±3</td> <td>30</td> </tr> <tr> <td>4</td> <td>25±2</td> <td>3</td> </tr> </tbody> </table>	Step	Temperature (°C)	Time (min)	1	-55±3	30	2	25±2	3	3	125±3	30	4	25±2
Step	Temperature (°C)	Time (min)															
1	-55±3	30															
2	25±2	3															
3	125±3	30															
4	25±2	3															
			Total: 100cycles Measured after exposure in the room condition for 24hrs														

LVC201B10 Series Specification

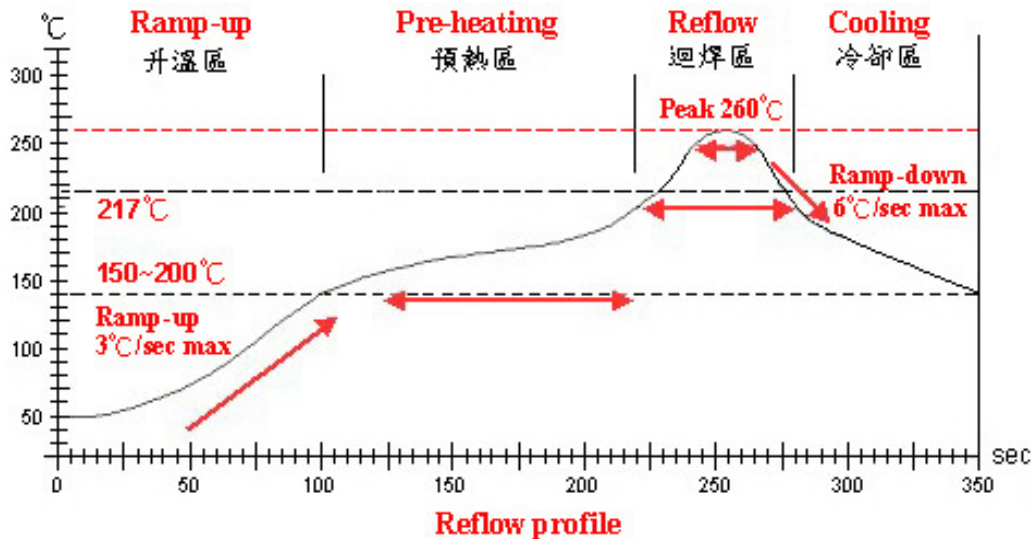

Lead-Free(LF) 標準溫度分析範圍

Refer to J-STD-020C

管制項目 Item.	升温區 Ramp-up	預熱區 Pre-heating	迴焊區 Reflow	Peak Temp	冷卻區 Cooling
溫度範圍 Temp.scope	R.T. ~ 150°C	150°C ~ 200°C	217°C	260±5°C	Peak Temp. ~ 150°C
標準時間 Time spec.	—	60 ~ 180 sec	60 ~ 150sec	20 ~ 40 sec	—
實際時間 Time result	—	75 ~ 100 sec	90 ~ 120 sec	20 ~ 35 sec	—

NOTE :

1. Re-flow possible times : within 2 times
2. Nitrogen adopted is recommended while in re-flow



LVC201B10 Series Specification

10 Product Test Data

Form No.: QF-1419
Edition: 2

Chilisin P/N: LVC201B10-2R2M-N

Test Item (unit)	L (uH)	RDC (Ω)±30%	Isat (mA)Typ.	A mm	B mm	C mm					
Customer Requirement	2.2±20%										
Spec Criteria		0.19	1300	2.0±0.25	1.6±0.25	1.0 Max.					
Test Condition	1MHz 200mV										
1	2.02	0.185	1300	2.03	1.71	0.94					
2	2.01	0.188	1300	2.05	1.72	0.95					
3	1.99	0.189	1300	2.05	1.72	0.96					
4	2.05	0.189	1300	2.05	1.72	0.95					
5	2.08	0.192	1300	2.05	1.72	0.96					
6											
7											
8											
9											
10											
11											
12											
13											
14											
15											
\bar{X}	2.03	0.1886	1300	2.046	1.718	0.952					
R	0.09	0.007	0	0.02	0.01	0.02					
Customer Sample											

Test Instrument

L: Agilent/HP4287A+Agilent/HP16197A,1MHz 200mV
 RDC:Chroma 16502 , or equivalent
 Isat & Irms: Agilent/HP4284A,1MHz 200mV

Appearance and Dimensions:

Appearance: Visual inspection according to inspection criteria.
 Dimension: Measured with slide calipers.

Test Conditions:

	Unless Otherwise Specified	In Case of Doubt
Temperature	Ordinary Temperature (15 to 35°C)	20 to 30°C
Humidity	Ordinary Humidity (25 to 85 %RH)	50 to 80 %RH

LVC201B10 Series Specification

11 Packaging:

11.1 Packaging -Cover tape

The force for tearing off cover tape is 10 to 100 grams in the arrow direction.

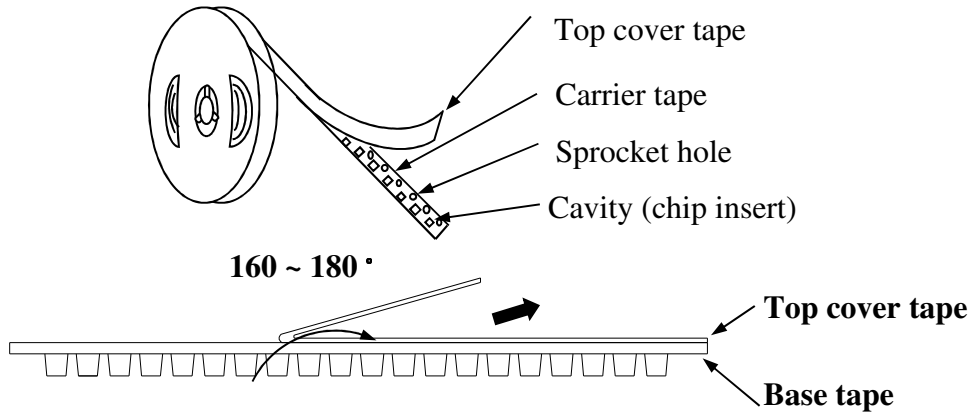

11.2 Packaging Quantity

TYPE	PCS/REEL
LVC201B10	2000

11.3 Reel Dimensions

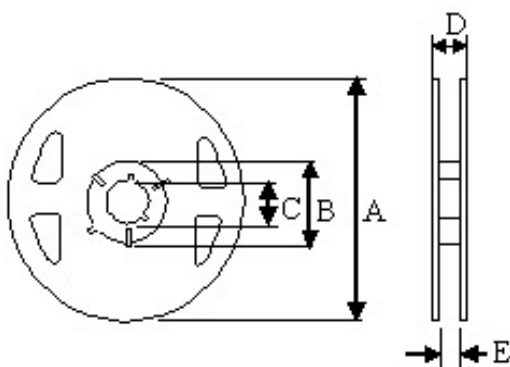

Dimensions in mm

TYPE	A	B	C	D	E
LVC201B10	180	60	13	14.4	8.4

LVC201B10 Series Specification

11 Packaging:

11.4 Tape Dimensions in mm

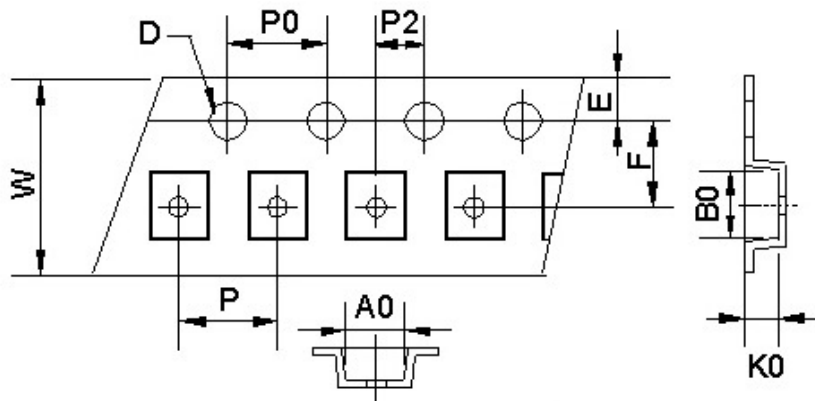

TYPE	A0	B0	K0	D	E	F	W	P	P0	P2
LVC201B10	1.9	2.2	1.15	1.55	1.75	3.5	8	4	4	2

12 Recommended Land Pattern:

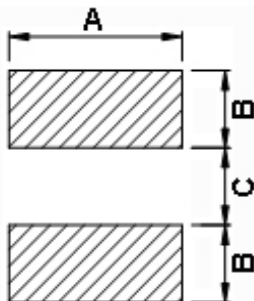

Dimensions in mm

TYPE	A	B	C
LVC201B10	1.8	0.8	0.8

13 Note:

1. Please make sure that your product has been evaluated and confirmed against your specifications when our product is mounted to your product.
2. Do not knock nor drop.
3. All the items and parameters in this product specification have been prescribed on the premise that our product is used for the purpose, under the condition and in the environment agreed upon between you and us. You are requested not to use our product deviating from such agreement.
4. Please keep the distance between transformer/coil and other components (refer to the standard IEC 950)
5. The moisture sensitivity level (MSL) of products is classified as level 1.

LVC201B10 Series Specification

13 Note:

6. Void Appearance tolerance Limit

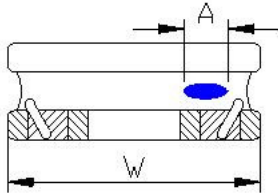

Exposed wire tolerance limit of coating resin part on product side.
The unilateral should be no more than two holes.

$$A \leq W/2 \text{ GOOD}$$

$$A > W/2 \text{ NG}$$

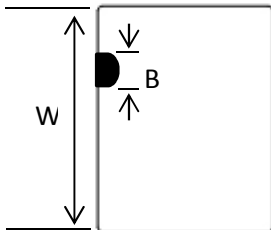

The appearance standard of the chipping size in top side.

$$B \leq W/5 \text{ GOOD}$$

$$B > W/5 \text{ NG}$$

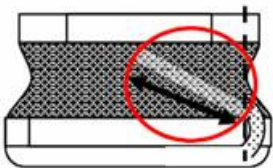

External appearance criterion for wxposed wire

Exposed end of the winding wire at the side should be acceptable.

LVC201B10 Series Specification

14 Graph: LVC201B10-2R2M-N

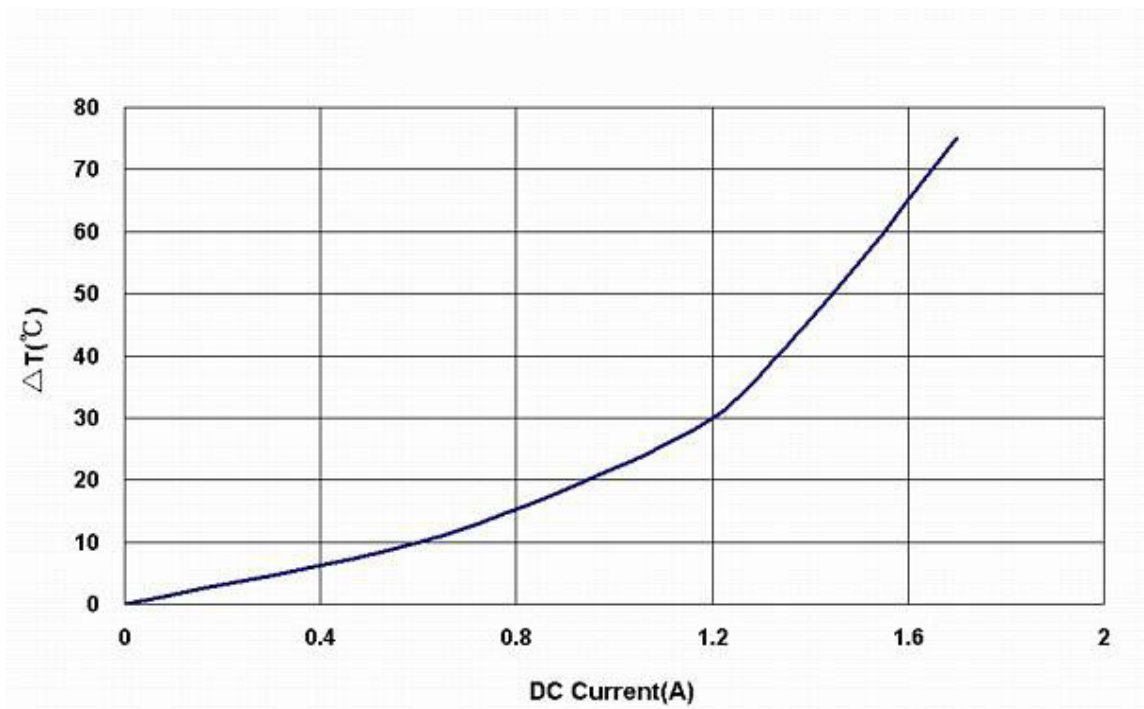
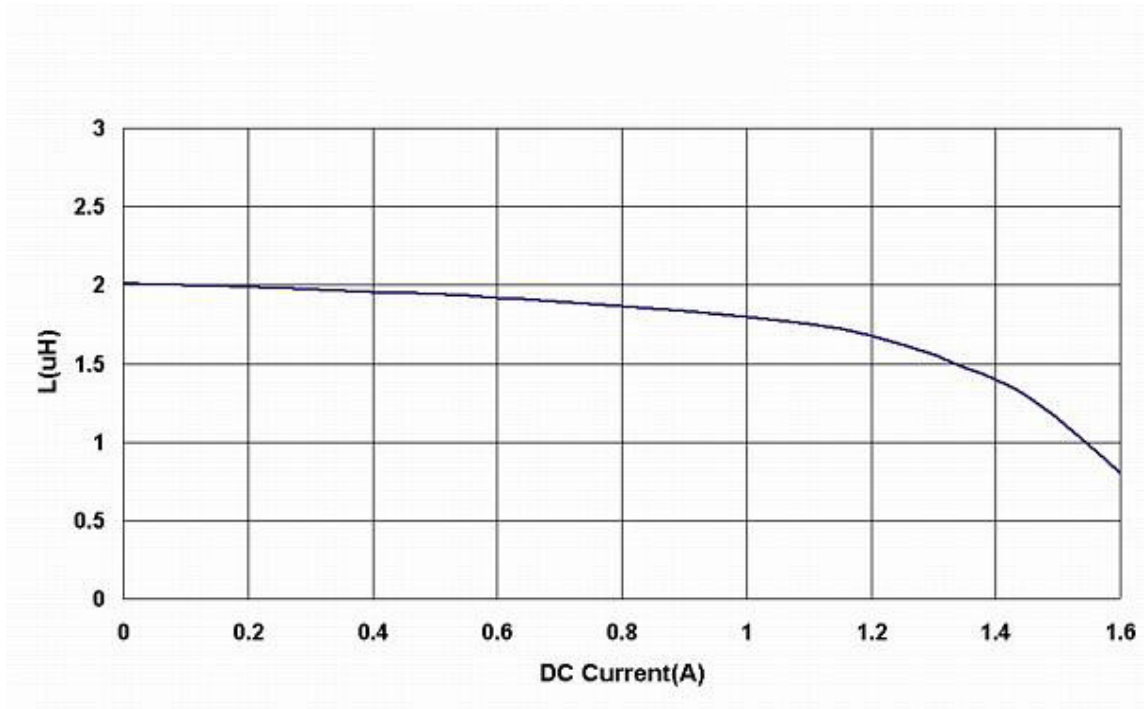

Temperature test conditions:

1. Start as the atmosphere temp. @25°C.
2. Take the reading once it becomes stable.
3. Need to wait 90Sec at least, then change to the next applied current value.

X-ON Electronics

Largest Supplier of Electrical and Electronic Components

Click to view similar products for [Fixed Inductors](#) category:

Click to view products by [Chilisin](#) manufacturer:

Other Similar products are found below :

[MLZ1608M6R8WTD25](#) [MLZ1608N6R8LT000](#) [MLZ1608N3R3LTD25](#) [MLZ1608N3R3LT000](#) [MLZ1608N150LT000](#)

[MLZ1608M150WTD25](#) [MLZ1608M3R3WTD25](#) [MLZ1608M3R3WT000](#) [MLZ1608M150WT000](#) [MLZ1608A1R5WT000](#)

[MLZ1608N1R5LT000](#) [B82432C1333K000](#) [PCMB053T-1R0MS](#) [PCMB053T-1R5MS](#) [PCMB104T-1R5MS](#) [CR32NP-100KC](#) [CR32NP-](#)

[151KC](#) [CR32NP-180KC](#) [CR32NP-181KC](#) [CR32NP-1R5MC](#) [CR32NP-390KC](#) [CR32NP-3R9MC](#) [CR32NP-680KC](#) [CR32NP-820KC](#)

[CR32NP-8R2MC](#) [CR43NP-390KC](#) [CR43NP-560KC](#) [CR43NP-680KC](#) [CR54NP-181KC](#) [CR54NP-470LC](#) [CR54NP-820KC](#) [CR54NP-8R5MC](#)

[MGDQ4-00004-P](#) [MGDU1-00016-P](#) [MHL1ECTTP18NJ](#) [MHL1JCTTD12NJ](#) [PE-51506NL](#) [PE-53601NL](#) [PE-53630NL](#) [PE-53824SNLT](#) [PE-](#)

[62892NL](#) [PE-92100NL](#) [PG0434.801NLT](#) [PG0936.113NLT](#) [PM06-2N7](#) [PM06-39NJ](#) [HC2LP-R47-R](#) [HC2-R47-R](#) [HC3-2R2-R](#) [HC8-1R2-R](#)