

MHCD201610A Series Specification

1 Scope: This specification applies to Alloy Molding power inductors

2 Part Numbering:

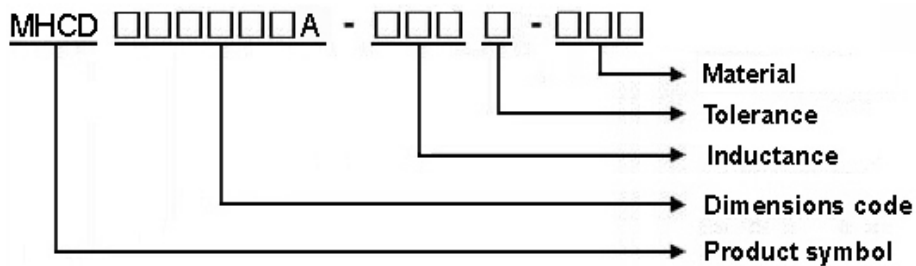

3 Rating:

Operating Temperature: $-40^{\circ}\text{C} \sim 125^{\circ}\text{C}$ (Including self - temperature rise)

Storage Temperature: $-40^{\circ}\text{C} \sim 125^{\circ}\text{C}$ (after PCB)

$-5^{\circ}\text{C} \sim 35^{\circ}\text{C}$, Humidity 45%~85% (before PCB)

4 Marking:

No Marking

5 Standard Testing Condition

	Unless otherwise specified	In case of doubt
Temperature	Ordinary Temperature(15 to 35°C)	20 to 30°C
Humidity	Ordinary Humidity(25 to 85% RH)	50 to 80 %RH

MHCD201610A Series Specification

6 Configuration and Dimensions:

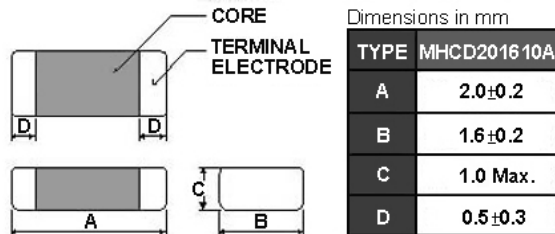

7 Electrical Characteristics:

Part No.	Inductance (uH)	Tolerance (±%)	Test Freq.	I _{rms} (A) Max.(Typ)	I _{sat} (A) Max.(Typ)	RDC(mΩ) Max.(Typ)
MHCD201610A-R24M-A8S	0.24	20	2MHz,0.2V	4.0(4.5)	4.2(6.0)	40(28)
MHCD201610A-R33M-A8S	0.33	20	2MHz,0.2V	3.5(3.8)	4.0(5.5)	48(40)
MHCD201610A-R47M-A8S	0.47	20	2MHz,0.2V	3.0(3.6)	3.2(5.0)	54(44)
MHCD201610A-R56M-A8S	0.56	20	2MHz,0.2V	2.8(3.3)	2.8(4.6)	59(46)
MHCD201610A-R68M-A8S	0.68	20	2MHz,0.2V	2.4(3.0)	2.7(4.2)	72(55)
MHCD201610A-1R0M-A8S	1	20	2MHz,0.2V	2.0(2.3)	2.2(3.4)	96(81)
MHCD201610A-1R5M-A8S	1.5	20	2MHz,0.2V	1.6(2.0)	2.1(2.8)	150(122)
MHCD201610A-2R2M-A8S	2.2	20	2MHz,0.2V	1.3(1.6)	2.0(2.4)	204(170)

NOTE:

1. Operating temperature range - 40°C ~ 125°C (Including self - temperature rise)
2. I_{sat} for Inductance drop 30% from its value without current.
3. I_{rms} for a 40°C temperature rise from 25°C ambient.
4. All test data is referenced to 25°C ambient
5. Absolute maximum voltage 20VDC

MHCD201610A Series Specification

8 MHCD201610A Series

8.1 Construction:

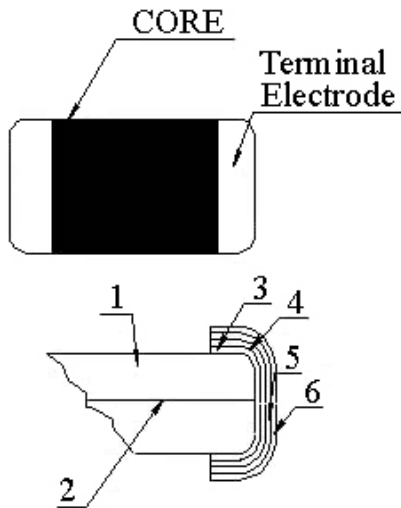

8.2 Material List:

No	Part	Material
1	Core	Metal Powder
2	Wire	Copper wire
3	Sputter/Plating	Cu
4	Silver Electrode	Ag
5	Plating	Ni
6	Plating	Sn

MHCD201610A Series Specification

9 Packaging:

9.1 Packaging -Cover Tape

The force for tearing off cover tape is 10 to 100 grams in the arrow direction.



9.2 Packaging Quantity

TYPE	PCS/REEL
MHCD201610A	3000

9.3 Reel Dimensions

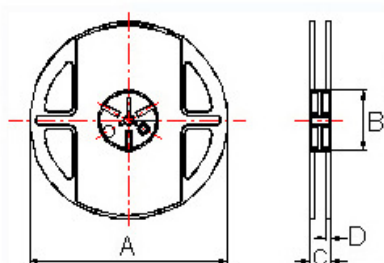

Dimensions in mm

TYPE	A	B	C	D
MHCD201610A	178	60	12	1.5

MHCD201610A Series Specification

9 Packaging:

9.4 Tape Dimensions in mm

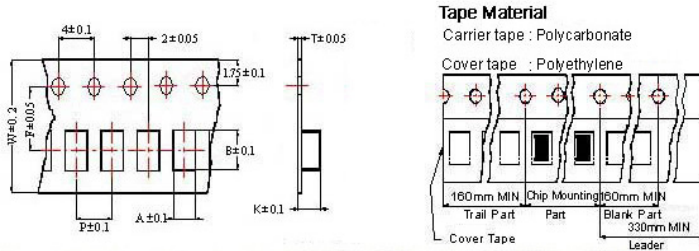

TYPE	A	B	T	W	P	F	K
MHCD201610A	1.8	2.2	0.22	8	4	3.5	1.15

10 Recommended Land Pattern:

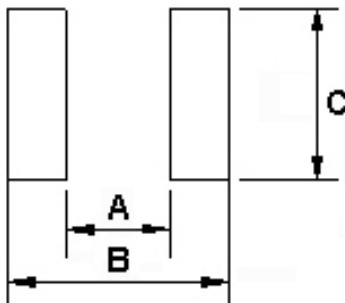

Dimensions in mm

TYPE	A	B	C
MHCD201610A	0.7	2.3	1.8

11 Note:

- Please make sure that your product has been evaluated and confirmed against your specifications when our product is mounted to your product.
- Do not knock nor drop.
- All the items and parameters in this product specification have been prescribed on the premise that our product is used for the purpose, under the condition and in the environment agreed upon between you and us. You are requested not to use our product deviating from such agreement.
- Please keep the distance between transformer/coil and other components (refer to the standard IEC 950)
- After manufacturing process, there might be slight irregular shape on the edge of the products, and it's a normal phenomenon that can be neglected
- The moisture sensitivity level (MSL) of products is classified as level 1.

MHCD201610A Series Specification

12 Graph: MHCD201610A-R47M-A8S

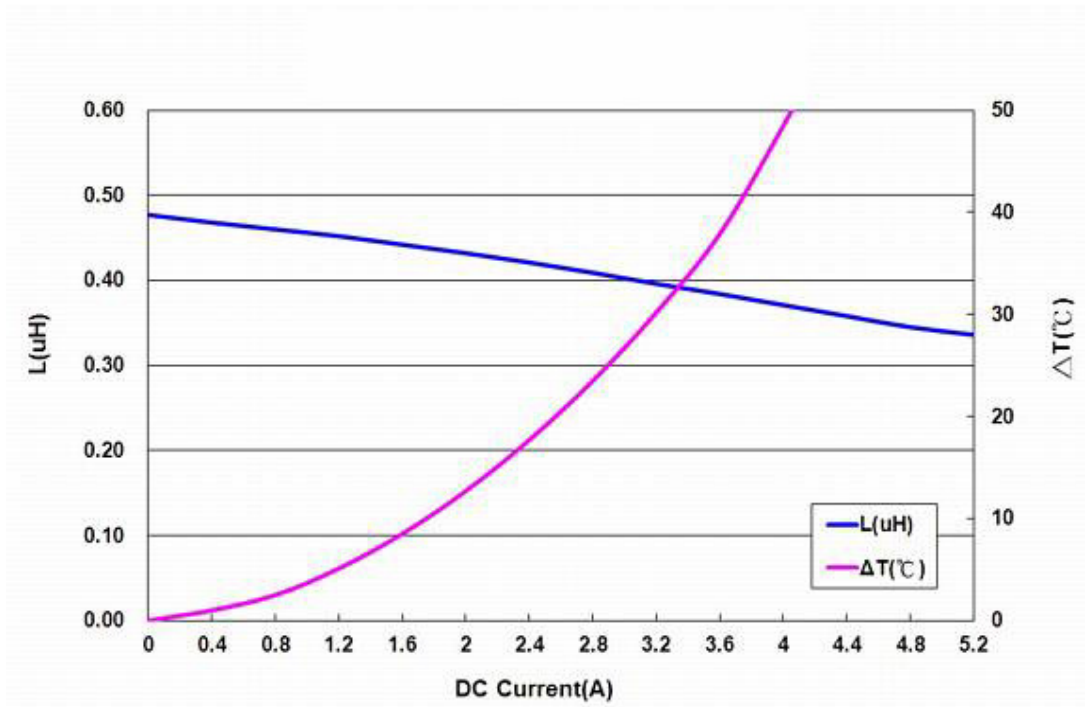

X-ON Electronics

Largest Supplier of Electrical and Electronic Components

Click to view similar products for [Fixed Inductors](#) category:

Click to view products by [Chilisin](#) manufacturer:

Other Similar products are found below :

[MLZ1608M6R8WTD25](#) [MLZ1608N6R8LT000](#) [MLZ1608N3R3LTD25](#) [MLZ1608N3R3LT000](#) [MLZ1608N150LT000](#)

[MLZ1608M150WTD25](#) [MLZ1608M3R3WTD25](#) [MLZ1608M3R3WT000](#) [MLZ1608M150WT000](#) [MLZ1608A1R5WT000](#)

[MLZ1608N1R5LT000](#) [B82432C1333K000](#) [PCMB053T-1R0MS](#) [PCMB053T-1R5MS](#) [PCMB104T-1R5MS](#) [CR32NP-100KC](#) [CR32NP-](#)

[151KC](#) [CR32NP-180KC](#) [CR32NP-181KC](#) [CR32NP-1R5MC](#) [CR32NP-390KC](#) [CR32NP-3R9MC](#) [CR32NP-680KC](#) [CR32NP-820KC](#)

[CR32NP-8R2MC](#) [CR43NP-390KC](#) [CR43NP-560KC](#) [CR43NP-680KC](#) [CR54NP-181KC](#) [CR54NP-470LC](#) [CR54NP-820KC](#) [CR54NP-8R5MC](#)

[MGDQ4-00004-P](#) [MGDU1-00016-P](#) [MHL1ECTTP18NJ](#) [MHL1JCTTD12NJ](#) [PE-51506NL](#) [PE-53601NL](#) [PE-53630NL](#) [PE-53824SNLT](#) [PE-](#)

[62892NL](#) [PE-92100NL](#) [PG0434.801NLT](#) [PG0936.113NLT](#) [PM06-2N7](#) [PM06-39NJ](#) [HC2LP-R47-R](#) [HC2-R47-R](#) [HC3-2R2-R](#) [HC8-1R2-R](#)