

## Cautions and Warnings

Please be noted that this spec is only for reference if you have projects designed with the product number listed in. If you are looking for new project design-in, please find BMQx Series specification/datasheet on Chilisin website. Or you may find our sales contact for more information on old part number at your convenience. Appreciated your attention and understanding.

**Note:** Please be sure to request approval specifications that provide further details of the products. Kindly note that the content of these specifications are subject to change or may be discontinued without prior notice. This product may not be designed/used in medical or high risk applications without Chilisin approval. Please contact our sales department before ordering.

## HPPC Series



HPPC series is low profile molding power choke with low RDC and high Q factor, so the efficiency performance is also superior. Its molded magnetic shielded type is suitable for high-density mounting and ultra-low buzz noise. Soldering conditions can be easily confirmed when mounting onto the board. This series also provides customers with embossed carrier type packaging for automatic mounting machine.

### Features

- RoHS, Halogen Free and REACH Compliance
- Low RDC
- High Q
- High Efficiency
- Ultra-low buzz noise

### Applications

- Laptops and PCs
- Switches and servers
- Base stations
- DC/DC converters

### Product Identification

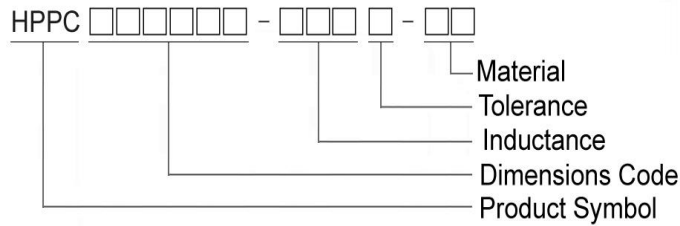

### Shape and Dimensions

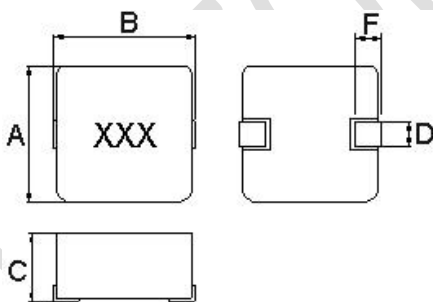

Dimensions in mm

| TYPE  | A        | B         | C       | D        | F        |
|-------|----------|-----------|---------|----------|----------|
| 04010 | 4.1±0.2  | 4.6±0.2   | 1.0Max  | 1.5±0.3  | 1.0±0.3  |
| 04011 | 4.1±0.2  | 4.6±0.2   | 1.1Max  | 1.5±0.3  | 1.0±0.3  |
| 04020 | 4.2±0.2  | 4.8±0.2   | 1.8±0.2 | 1.5±0.3  | 1.1±0.3  |
| 05011 | 5.5±0.2  | 5.7±0.2   | 1.1Max  | 2.0±0.3  | 1.5±0.3  |
| 05030 | 5.5±0.25 | 5.85±0.25 | 2.8±0.2 | 2.0±0.25 | 1.5±0.25 |
| 06011 | 6.6±0.2  | 6.95±0.35 | 1.1Max  | 3.0±0.3  | 1.6±0.3  |
| 06020 | 6.8±0.2  | 6.95±0.35 | 1.8±0.2 | 3.0±0.3  | 1.6±0.3  |
| 06030 | 6.8±0.2  | 7.3±0.2   | 2.8±0.2 | 3.0±0.3  | 1.6±0.3  |
| 10040 | 10.2±0.3 | 11.3±0.3  | 3.8±0.2 | 3.0±0.5  | 2.5±0.5  |

### Recommended Pattern

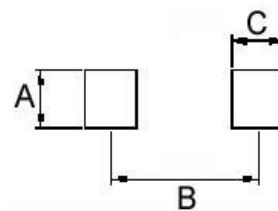

Dimensions in mm

| TYPE  | A   | B    | C    |
|-------|-----|------|------|
| 04010 | 2.5 | 3.7  | 1.5  |
| 04011 | 2.5 | 3.7  | 1.5  |
| 04020 | 2.5 | 3.7  | 1.5  |
| 05011 | 2.5 | 4.1  | 1.9  |
| 05030 | 2.5 | 4.6  | 1.9  |
| 06011 | 3.5 | 6.05 | 2.35 |
| 06020 | 3.5 | 6.05 | 2.35 |
| 06030 | 3.5 | 6.05 | 2.35 |
| 10040 | 4.0 | 9.50 | 3.50 |

# Molding Power Inductors – HPPC Series

## Electrical Characteristics

| Part Number       | Inductance (uH) | Tolerance (±%) | Test Frequency (kHz) | RDC(mΩ) Max(Typ.) | Isat(A) Max(Typ.) | Irms(A) Max(Typ.) | Marking |
|-------------------|-----------------|----------------|----------------------|-------------------|-------------------|-------------------|---------|
| HPPC04010-R33M-A8 | 0.33            | 20             | 100                  | 14(12)            | 9.0(11)           | 6.0(7.0)          | R33     |
| HPPC04010-1R0M-A8 | 1.0             | 20             | 100                  | 43(39)            | 4.0(5.0)          | 4.0(4.5)          | 1R0     |

**Note: When ordering, please specify tolerance code. Tolerance: M=±20%**

- Operating temperature range - 55°C ~ 125°C(Including self - temperature rise)
- Isat for Inductance drop 30% from its value without current
- I rms for a 40°C temperature rise from 25°C ambient with current
- Absolute maximum voltage 30VDC
- Measure Equipment :  
 L : WK 3260B or WK 6500P, 100kHz 0.5V  
 RDC : CHEN HWA 502 or CHEN HWA 46502B  
 I rms : CHROMA 1810

**Test Instruments :** WK3260B Impedance / Material Analyzer

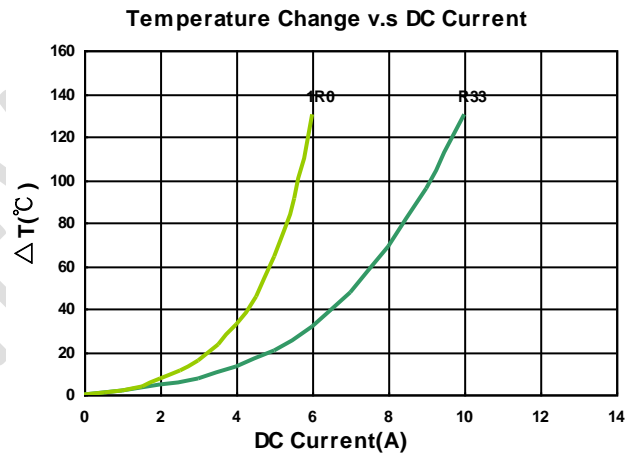
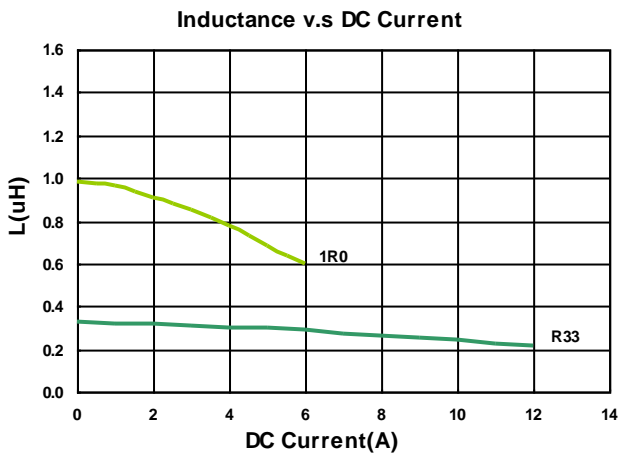

# Molding Power Inductors – HPPC Series

## Electrical Characteristics

| Part Number       | Inductance (uH) | Tolerance (±%) | Test Frequency (kHz) | RDC(mΩ) Max(Typ.) | Isat(A) Max(Typ.) | Irms(A) Max(Typ.) | Marking |
|-------------------|-----------------|----------------|----------------------|-------------------|-------------------|-------------------|---------|
| HPPC04011-1R0M-A8 | 1.0             | 20             | 100                  | 38.5(35)          | 5.4(6.0)          | 4.3(4.8)          | 1R0     |
| HPPC04011-2R2M-A8 | 2.2             | 20             | 100                  | 82(75)            | 3.5(4.0)          | 3.0(3.3)          | 2R2     |

**Note: When ordering, please specify tolerance code. Tolerance: M=±20%**

- Operating temperature range - 55°C ~ 125°C(Including self - temperature rise)
- Isat for Inductance drop 30% from its value without current
- I rms for a 40°C temperature rise from 25°C ambient with current
- Absolute maximum voltage 30VDC
- Measure Equipment :  
 L : WK 3260B or WK 6500P, 100kHz 0.5V  
 RDC : CHEN HWA 502 or CHEN HWA 46502B  
 I rms : CHROMA 1810

**Test Instruments :** WK3260B Impedance / Material Analyzer

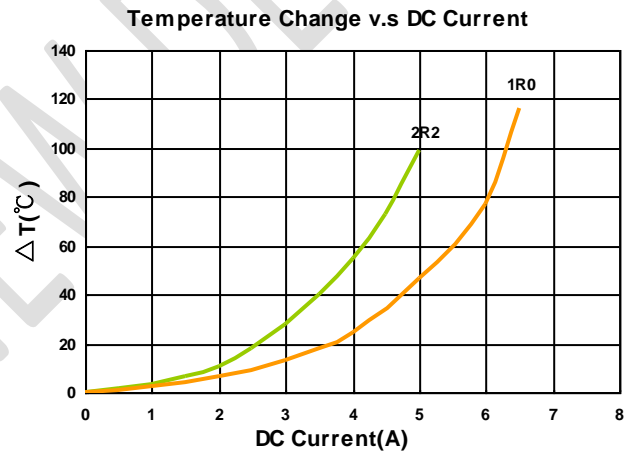
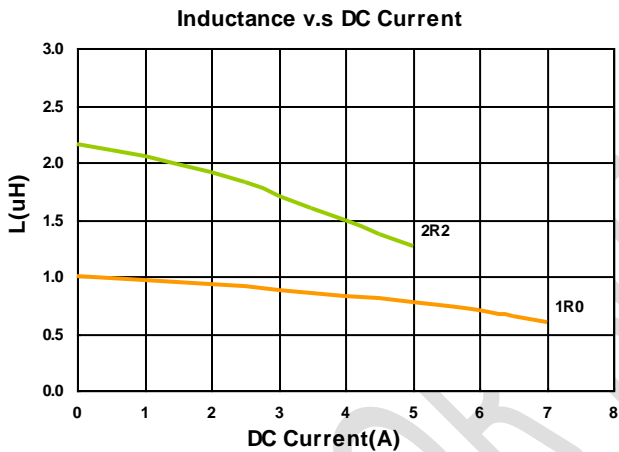

# Molding Power Inductors – HPPC Series

## Electrical Characteristics

| Part Number       | Inductance (uH) | Tolerance (±%) | Test Frequency (kHz) | RDC(mΩ) Max(Typ.) | Isat(A) Max(Typ.) | Irms(A) Max(Typ.) | Marking |
|-------------------|-----------------|----------------|----------------------|-------------------|-------------------|-------------------|---------|
| HPPC04020-R22M-Q8 | 0.22            | 20             | 100                  | 5.5(5.0)          | 18(20)            | 10(11)            | R22     |
| HPPC04020-1R0M-Q8 | 1.0             | 20             | 100                  | 17(16)            | 8.0(8.5)          | 5.5(6.0)          | 1R0     |
| HPPC04020-2R2M-Q8 | 2.2             | 20             | 100                  | 38.5(35)          | 6.0(6.5)          | 4.0(4.5)          | 2R2     |
| HPPC04020-4R7M-Q8 | 4.7             | 20             | 100                  | 85(77)            | 4.0(4.5)          | 2.5(2.8)          | 4R7     |

**Note: When ordering, please specify tolerance code. Tolerance: M=±20%**

- Operating temperature range - 55°C ~ 125°C(Including self - temperature rise)
- Isat for Inductance drop 30% from its value without current
- I rms for a 40°C temperature rise from 25°C ambient with current
- Absolute maximum voltage 30VDC
- Measure Equipment :  
 L : WK 3260B or WK 6500P, 100kHz 0.5V  
 RDC : CHEN HWA 502 or CHEN HWA 46502B  
 I rms : CHROMA 1810

**Test Instruments :** WK3260B Impedance / Material Analyzer

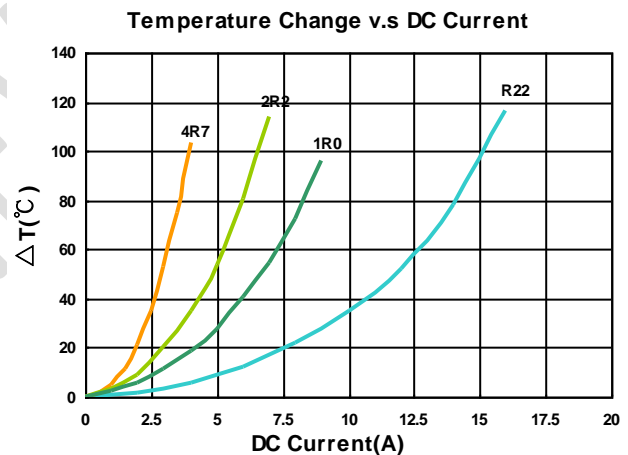
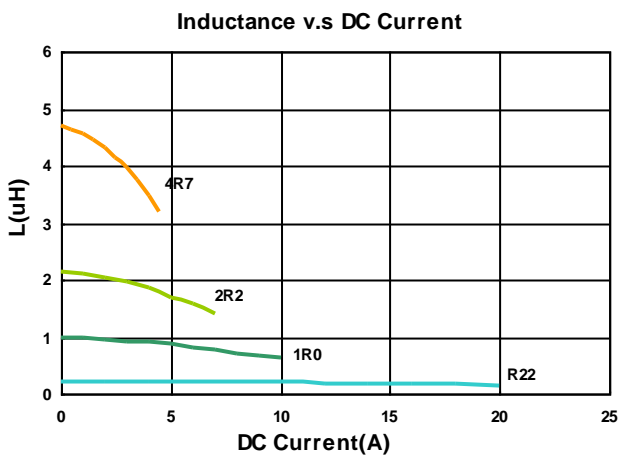

# Molding Power Inductors – HPPC Series

## Electrical Characteristics

| Part Number       | Inductance (uH) | Tolerance (±%) | Test Frequency (kHz) | RDC(mΩ) Max(Typ.) | Isat(A) Max(Typ.) | Irms(A) Max(Typ.) | Marking |
|-------------------|-----------------|----------------|----------------------|-------------------|-------------------|-------------------|---------|
| HPPC05011-1R0M-A8 | 1.0             | 20             | 100                  | 33(30)            | 7.0(7.5)          | 4.8(5.3)          | 1R0     |

**Note: When ordering, please specify tolerance code. Tolerance: M=±20%**

- Operating temperature range - 55°C ~ 125°C(Including self - temperature rise)
- Isat for Inductance drop 30% from its value without current
- I rms for a 40°C temperature rise from 25°C ambient with current
- Absolute maximum voltage 30VDC
- Measure Equipment :  
 L : WK 3260B or WK 6500P, 100kHz 0.5V  
 RDC : CHEN HWA 502 or CHEN HWA 46502B  
 I rms : CHROMA 1810

**Test Instruments :** WK3260B Impedance / Material Analyzer

**Inductance v.s DC Current**

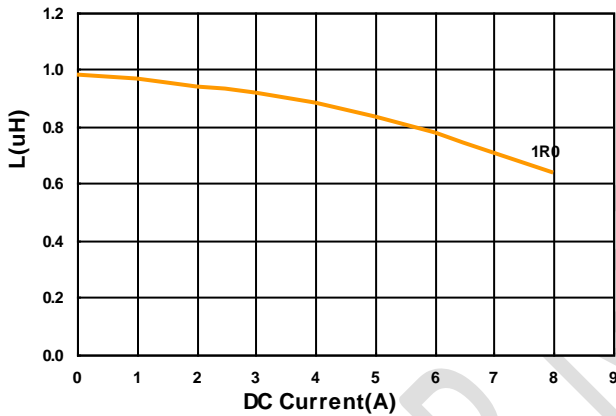

**Temperature Change v.s DC Current**

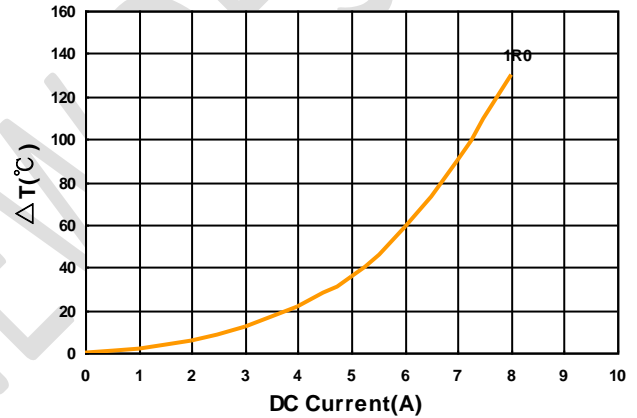

# Molding Power Inductors – HPPC Series

## Electrical Characteristics

| Part Number       | Inductance (uH) | Tolerance (±%) | Test Frequency (kHz) | RDC(mΩ) Max(Typ.) | Isat(A) Max(Typ.) | Irms(A) Max(Typ.) | Marking |
|-------------------|-----------------|----------------|----------------------|-------------------|-------------------|-------------------|---------|
| HPPC05030-R22M-Q8 | 0.22            | 20             | 100                  | 3.90(3.5)         | 28(32)            | 18.0(20.0)        | R22     |
| HPPC05030-R36M-Q8 | 0.36            | 20             | 100                  | 4.95(4.5)         | 23(25)            | 12.5(13.5)        | R36     |
| HPPC05030-R68M-Q8 | 0.68            | 20             | 100                  | 6.30(5.7)         | 17(18)            | 11.0(12.0)        | R68     |
| HPPC05030-1R0M-Q8 | 1.0             | 20             | 100                  | 9.8(8.9)          | 16(18)            | 9.00(9.50)        | 1R0     |
| HPPC05030-1R5M-Q8 | 1.5             | 20             | 100                  | 15(13.5)          | 12.5(13.5)        | 7.50(8.0)         | 1R5     |
| HPPC05030-2R2M-Q8 | 2.2             | 20             | 100                  | 20(18)            | 11.5(12.5)        | 6.00(6.5)         | 2R2     |
| HPPC05030-4R7M-Q8 | 4.7             | 20             | 100                  | 40(37)            | 6.5(7.50)         | 4.50(5.0)         | 4R7     |

**Note: When ordering, please specify tolerance code. Tolerance: M=±20%**

- Operating temperature range - 55°C ~ 125°C(Including self - temperature rise)
- Isat for Inductance drop 30% from its value without current
- I rms for a 40°C temperature rise from 25°C ambient with current
- Absolute maximum voltage 30VDC
- Measure Equipment :  
 L : WK 3260B or WK 6500P, 100kHz 0.5V  
 RDC : CHEN HWA 502 or CHEN HWA 46502B  
 I rms : CHROMA 1810

**Test Instruments :** WK3260B Impedance / Material Analyzer

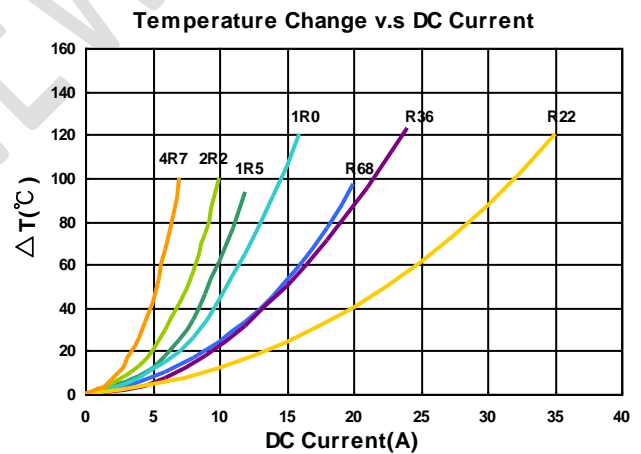
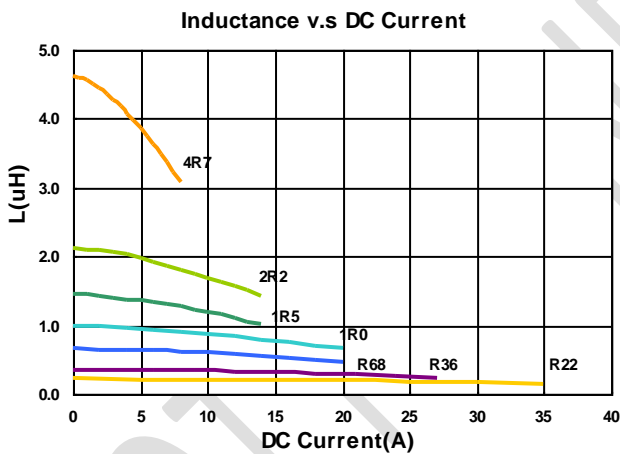

# Molding Power Inductors – HPPC Series

## Electrical Characteristics

| Part Number       | Inductance (uH) | Tolerance (±%) | Test Frequency (kHz) | RDC(mΩ) Max(Typ.) | Isat(A) Max(Typ.) | Irms(A) Max(Typ.) | Marking |
|-------------------|-----------------|----------------|----------------------|-------------------|-------------------|-------------------|---------|
| HPPC06011-1R0M-A8 | 1.0             | 20             | 100                  | 26(24.5)          | 7.0(7.8)          | 6.8(7.3)          | 1R0     |
| HPPC06011-2R2M-A8 | 2.2             | 20             | 100                  | 57(52)            | 5.0(6.0)          | 4.2(4.6)          | 2R2     |

**Note: When ordering, please specify tolerance code. Tolerance: M=±20%**

- Operating temperature range - 55°C ~ 125°C(Including self - temperature rise)
- Isat for Inductance drop 30% from its value without current
- Irms for a 40°C temperature rise from 25°C ambient with current
- Absolute maximum voltage 30VDC
- Measure Equipment :  
 L : WK 3260B or WK 6500P, 100kHz 0.5V  
 RDC : CHEN HWA 502 or CHEN HWA 46502B  
 Irms : CHROMA 1810

**Test Instruments :** WK3260B Impedance / Material Analyzer

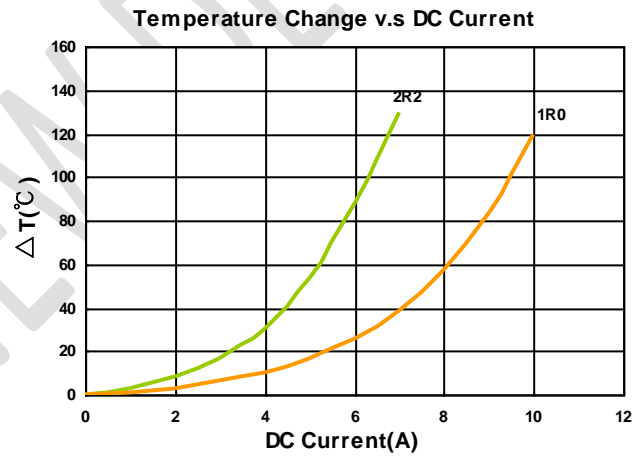
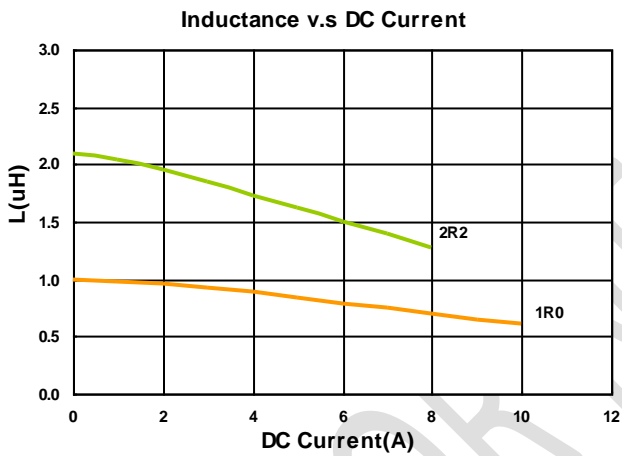



# Molding Power Inductors – HPPC Series

## Electrical Characteristics

| Part Number       | Inductance (uH) | Tolerance (±%) | Test Frequency (kHz) | RDC(mΩ) Max(Typ.) | Isat(A) Max(Typ.) | Irms(A) Max(Typ.) | Marking |
|-------------------|-----------------|----------------|----------------------|-------------------|-------------------|-------------------|---------|
| HPPC06020-4R7M-Q8 | 4.7             | 20             | 100                  | 48(43.7)          | 6.0(6.8)          | 4.2(4.7)          | 4R7     |

**Note: When ordering, please specify tolerance code. Tolerance: M=±20%**

- Operating temperature range - 55°C ~ 125°C(Including self - temperature rise)
- Isat for Inductance drop 30% from its value without current
- I rms for a 40°C temperature rise from 25°C ambient with current
- Absolute maximum voltage 30VDC
- Measure Equipment :  
 L : WK 3260B or WK 6500P, 100kHz 0.5V  
 RDC : CHEN HWA 502 or CHEN HWA 46502B  
 I rms : CHROMA 1810

**Test Instruments :** WK3260B Impedance / Material Analyzer

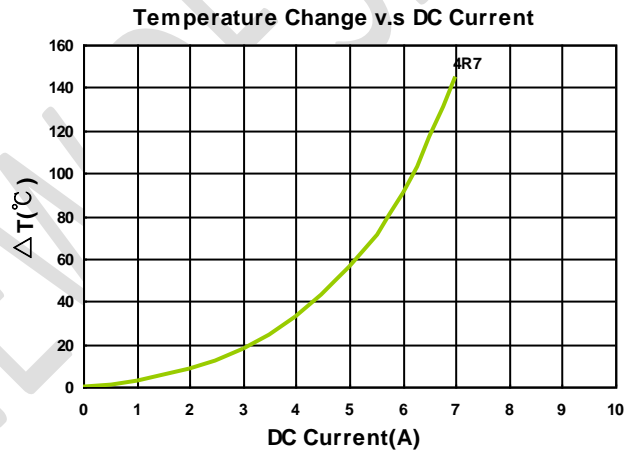
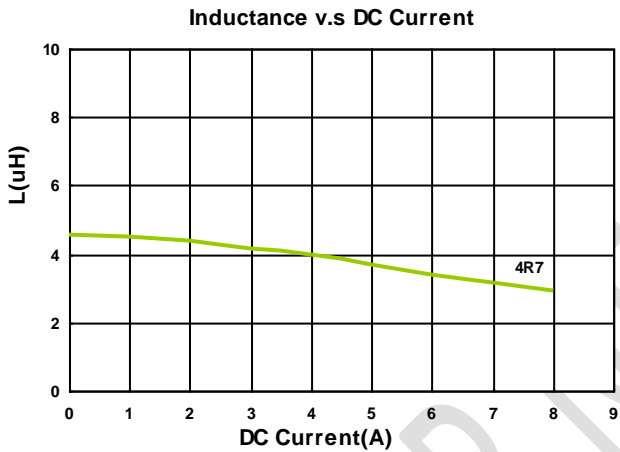

# Molding Power Inductors – HPPC Series

## Electrical Characteristics

| Part Number       | Inductance (uH) | Tolerance (±%) | Test Frequency (kHz) | RDC(mΩ) Max(Typ.) | Isat(A) Max(Typ.) | Irms(A) Max(Typ.) | Marking |
|-------------------|-----------------|----------------|----------------------|-------------------|-------------------|-------------------|---------|
| HPPC06030-R22M-Q8 | 0.22            | 20             | 100                  | 2.0(1.8)          | 35(40)            | 25(27)            | R22     |
| HPPC06030-R36M-Q8 | 0.36            | 20             | 100                  | 2.6(2.3)          | 27(32)            | 23(25)            | R36     |
| HPPC06030-R47M-Q8 | 0.47            | 20             | 100                  | 3.3(2.9)          | 25(27)            | 19(20)            | R47     |
| HPPC06030-R56M-Q8 | 0.56            | 20             | 100                  | 3.9(3.5)          | 23(25)            | 17(18)            | R56     |
| HPPC06030-R68M-Q8 | 0.68            | 20             | 100                  | 4.2(3.8)          | 18(20)            | 16(17)            | R68     |
| HPPC06030-1R0M-Q8 | 1.0             | 20             | 100                  | 5.3(4.8)          | 17(19)            | 14(15)            | 1R0     |
| HPPC06030-1R5M-Q8 | 1.5             | 20             | 100                  | 7.7(7.0)          | 15(17)            | 11(11.5)          | 1R5     |
| HPPC06030-2R2M-Q8 | 2.2             | 20             | 100                  | 9.4(8.5)          | 12(12.5)          | 10.5(11)          | 2R2     |
| HPPC06030-3R3M-Q8 | 3.3             | 20             | 100                  | 15(13.5)          | 9.0(9.5)          | 8.0(8.5)          | 3R3     |
| HPPC06030-4R7M-Q8 | 4.7             | 20             | 100                  | 22.0(20)          | 6.5(7.0)          | 6.0(6.5)          | 4R7     |
| HPPC06030-6R8M-Q8 | 6.8             | 20             | 100                  | 38.5(35)          | 6.0(6.5)          | 5.3(5.8)          | 6R8     |
| HPPC06030-8R2M-Q8 | 8.2             | 20             | 100                  | 47.0(43)          | 5.5(6.0)          | 5.0(5.4)          | 8R2     |
| HPPC06030-100M-Q8 | 10              | 20             | 100                  | 47.0(43)          | 5.0(5.5)          | 4.8(5.3)          | 100     |

**Note: When ordering, please specify tolerance code. Tolerance: M=±20%**

- Operating temperature range - 55°C ~ 125°C(Including self - temperature rise)
- Isat for Inductance drop 30% from its value without current
- I rms for a 40°C temperature rise from 25°C ambient with current
- Absolute maximum voltage 30VDC
- Measure Equipment :  
 L : WK 3260B or WK 6500P, 100kHz 0.5V  
 RDC : CHEN HWA 502 or CHEN HWA 46502B  
 I rms : CHROMA 1810

**Test Instruments :** WK3260B Impedance / Material Analyzer

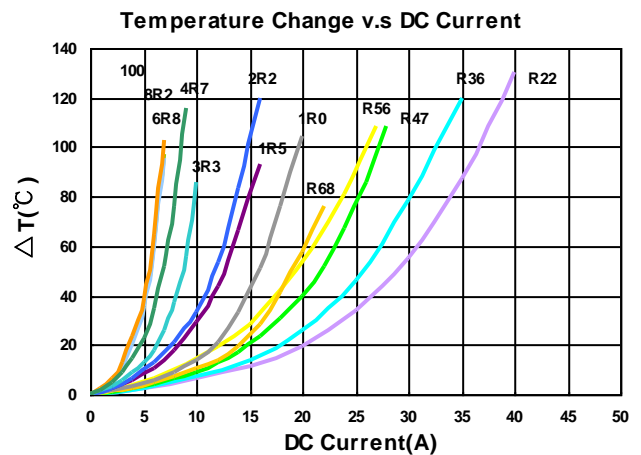
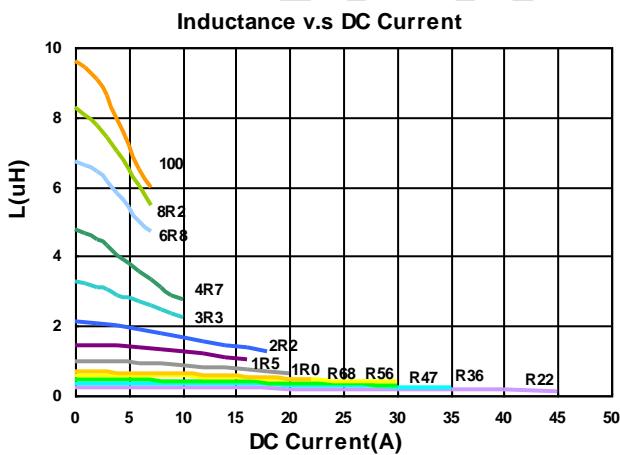

# Molding Power Inductors – HPPC Series

## Electrical Characteristics

| Part Number       | Inductance (uH) | Tolerance (±%) | Test Frequency (kHz) | RDC(mΩ) Max(Typ.) | Isat(A) Max(Typ.) | Irms(A) Max(Typ.) | Marking |
|-------------------|-----------------|----------------|----------------------|-------------------|-------------------|-------------------|---------|
| HPPC10040-R22M-Q8 | 0.22            | 20             | 100                  | 0.54(0.45)        | 55(60)            | 40(42)            | R22     |
| HPPC10040-R33M-Q8 | 0.33            | 20             | 100                  | 0.68(0.62)        | 45(50)            | 32(35)            | R33     |
| HPPC10040-R56M-Q8 | 0.56            | 20             | 100                  | 1.2(1.0)          | 40(45)            | 28(30)            | R56     |
| HPPC10040-R68M-Q8 | 0.68            | 20             | 100                  | 1.5(1.3)          | 32(37)            | 25(27)            | R68     |
| HPPC10040-1R0M-Q8 | 1.0             | 20             | 100                  | 2.4(2.2)          | 26(30)            | 23(25)            | 1R0     |
| HPPC10040-2R2M-Q8 | 2.2             | 20             | 100                  | 4.7(4.3)          | 17(20)            | 15(15.6)          | 2R2     |
| HPPC10040-3R3M-Q8 | 3.3             | 20             | 100                  | 7.9(7.2)          | 16(18)            | 12(12.5)          | 3R3     |
| HPPC10040-4R7M-Q8 | 4.7             | 20             | 100                  | 10.5(9.5)         | 13(14)            | 10.5(11)          | 4R7     |
| HPPC10040-6R8M-Q8 | 6.8             | 20             | 100                  | 16.5(15)          | 9.0(10)           | 8.5(9.0)          | 6R8     |
| HPPC10040-100M-Q8 | 10              | 20             | 100                  | 24(22)            | 8.5(9.0)          | 8.0(8.5)          | 100     |

**Note: When ordering, please specify tolerance code. Tolerance: M=±20%**

- Operating temperature range - 55°C ~ 125°C(Including self - temperature rise)
- Isat for Inductance drop 30% from its value without current
- I rms for a 40°C temperature rise from 25°C ambient with current
- Absolute maximum voltage 30VDC
- Measure Equipment :  
 L : WK 3260B or WK 6500P, 100kHz 0.5V  
 RDC : CHEN HWA 502 or CHEN HWA 46502B  
 I rms : CHROMA 1810

**Test Instruments : WK3260B Impedance / Material Analyzer**

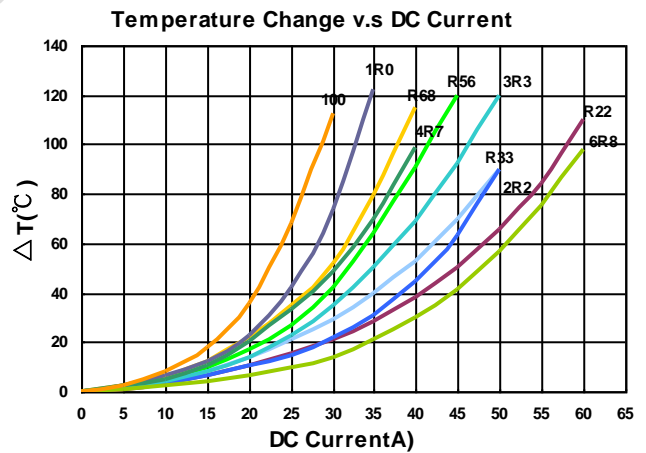
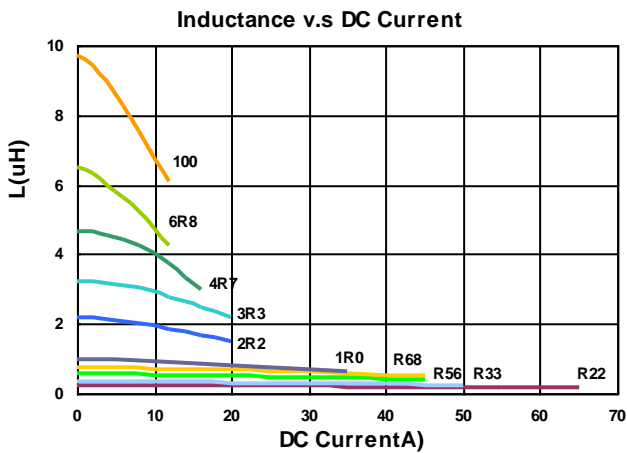

## Packaging Specifications

Tape Dimensions

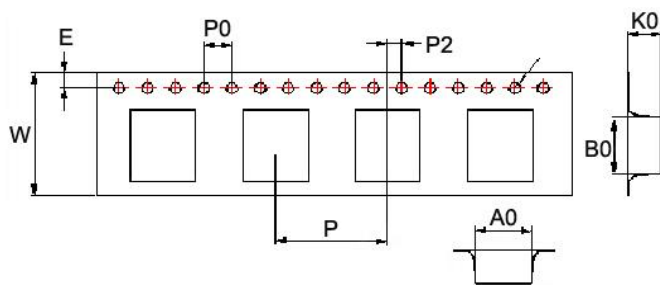

Tape Material

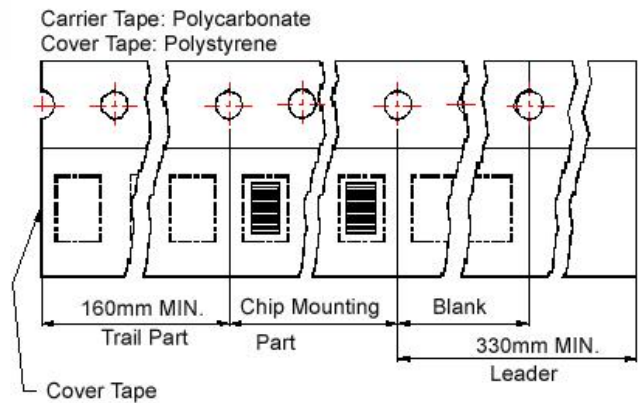

Reel Dimensions

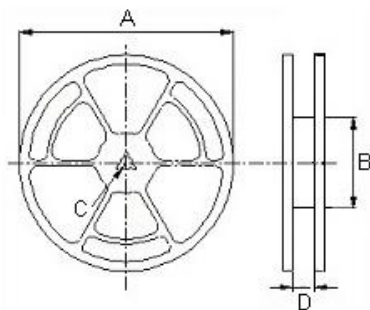

Dimensions in mm

| TYPE  | Tape Dimensions |      |      |      |      |    |    |    |    | Reel Dimensions |     |    |      | Quantity<br>PCS / REEL |
|-------|-----------------|------|------|------|------|----|----|----|----|-----------------|-----|----|------|------------------------|
|       | A0              | B0   | K0   | D    | E    | W  | P  | P0 | P2 | A               | B   | C  | D    |                        |
| 04010 | 4.4             | 4.9  | 1.4  | 1.55 | 1.75 | 12 | 8  | 4  | 2  | 330             | 100 | 13 | 13.4 | 2000                   |
| 04011 | 4.4             | 4.9  | 1.5  | 1.55 | 1.75 | 12 | 8  | 4  | 2  | 330             | 100 | 13 | 13.4 | 2000                   |
| 04020 | 4.5             | 5.1  | 2.4  | 1.55 | 1.75 | 12 | 8  | 4  | 2  | 330             | 100 | 13 | 13.4 | 2000                   |
| 05011 | 5.9             | 6.2  | 1.5  | 1.55 | 1.75 | 16 | 12 | 4  | 2  | 330             | 100 | 13 | 16   | 2000                   |
| 05030 | 5.9             | 6.25 | 3.4  | 1.55 | 1.75 | 16 | 12 | 4  | 2  | 330             | 100 | 13 | 16   | 1000                   |
| 06011 | 6.9             | 7.4  | 1.5  | 1.55 | 1.75 | 16 | 12 | 4  | 2  | 330             | 100 | 13 | 16   | 1000                   |
| 06020 | 7.05            | 7.6  | 2.4  | 1.55 | 1.75 | 16 | 12 | 4  | 2  | 330             | 100 | 13 | 16   | 1000                   |
| 06030 | 7.0             | 7.6  | 3.4  | 1.55 | 1.75 | 16 | 12 | 4  | 2  | 330             | 100 | 13 | 16   | 1000                   |
| 10040 | 10.6            | 11.7 | 4.25 | 1.55 | 1.75 | 24 | 16 | 4  | 2  | 330             | 100 | 13 | 24.4 | 500                    |

## X-ON Electronics

Largest Supplier of Electrical and Electronic Components

*Click to view similar products for [Fixed Inductors](#) category:*

*Click to view products by [Chilisin](#) manufacturer:*

Other Similar products are found below :

[MLZ1608M6R8WTD25](#) [MLZ1608N6R8LT000](#) [MLZ1608N3R3LTD25](#) [MLZ1608N3R3LT000](#) [MLZ1608N150LT000](#)

[MLZ1608M150WTD25](#) [MLZ1608M3R3WTD25](#) [MLZ1608M3R3WT000](#) [MLZ1608M150WT000](#) [MLZ1608A1R5WT000](#)

[MLZ1608N1R5LT000](#) [B82432C1333K000](#) [PCMB053T-1R0MS](#) [PCMB053T-1R5MS](#) [PCMB104T-1R5MS](#) [CR32NP-100KC](#) [CR32NP-](#)

[151KC](#) [CR32NP-180KC](#) [CR32NP-181KC](#) [CR32NP-1R5MC](#) [CR32NP-390KC](#) [CR32NP-3R9MC](#) [CR32NP-680KC](#) [CR32NP-820KC](#)

[CR32NP-8R2MC](#) [CR43NP-390KC](#) [CR43NP-560KC](#) [CR43NP-680KC](#) [CR54NP-181KC](#) [CR54NP-470LC](#) [CR54NP-820KC](#) [CR54NP-8R5MC](#)

[MGDQ4-00004-P](#) [MGDU1-00016-P](#) [MHL1ECTTP18NJ](#) [MHL1JCTTD12NJ](#) [PE-51506NL](#) [PE-53601NL](#) [PE-53630NL](#) [PE-53824SNLT](#) [PE-](#)

[62892NL](#) [PE-92100NL](#) [PG0434.801NLT](#) [PG0936.113NLT](#) [PM06-2N7](#) [PM06-39NJ](#) [HC2LP-R47-R](#) [HC2-R47-R](#) [HC3-2R2-R](#) [HC8-1R2-R](#)