

① AWPO3M-B

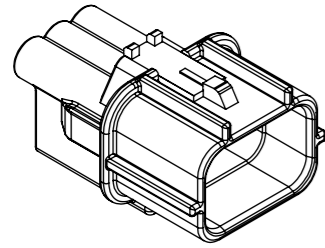

ISO VIEW

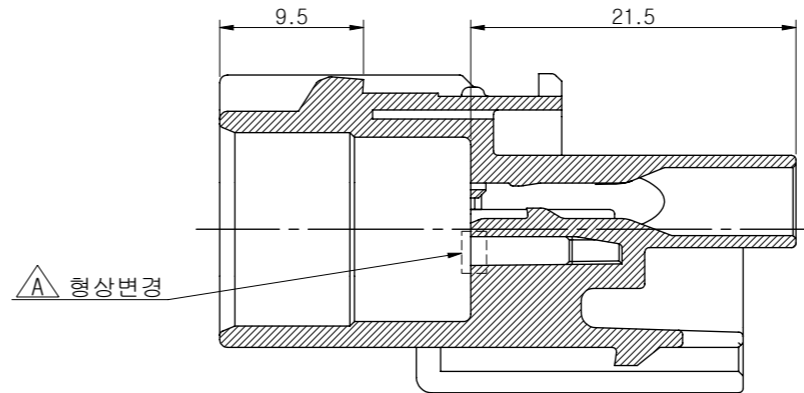
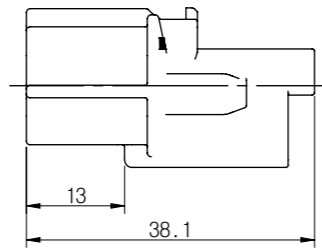
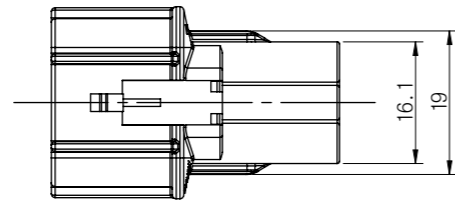
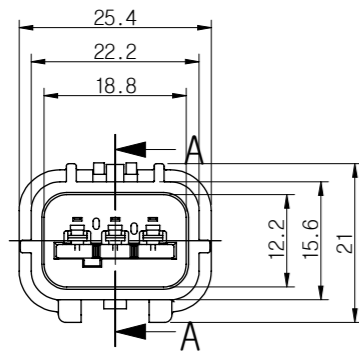

SECTION A-A (2/1)

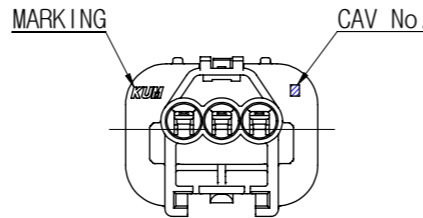

- 주 기 -

1. 사용상 유해한 흠, BURR등이 없을 것.
2. 명시되지 않은 공차는 일반공차에 준할 것.
3. CAV. No. 및 MARKING은 당사규격에 준하여 각인할 것.
4. ASSY 부품
 - 1) FRONT HOLDER:HP411-03040

△ C 2) TERMINAL

적용 전선(SQ)	PART NAME	PART NO.
0.22	TML AWP-M-SS	TP131-00400
0.22	TML AWP-M-SS-Au	TP131-00410
0.3~0.5	TML AWP-M-S	TP131-00100
0.3~0.5	TML AWP-M-S-Au	TP131-00110
0.75~1.25	TML AWP-M-M	TP131-00200
0.75~1.25	TML AWP-M-M-Au	TP131-00210

3) WIRE SEAL

적용 전선 표준사양명	PART NAME	PART NO.
Φ0.9	W/S AWP-0.9S(MB)	EB010-01140
Φ1.4	W/S AWP-1.4S(BR)	EB010-01050
Φ1.9	W/S AWP-1.9S(GN)	EB010-01030
Φ2.3	W/S AWP-2.3S(GY)	EB010-01120
Φ2.7	W/S AWP-2.7S(OR)	EB010-01100
-	W/S AWP-V(R)	EB010-01060

5. 본 부품은 방수형 CONNECTOR 임.

② F/H AWPO3M-L (2/1)

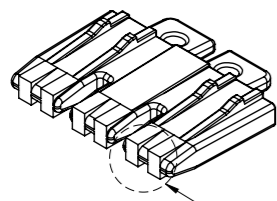

ISO VIEW

△ A 3-형상변경

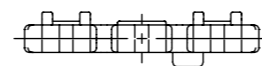
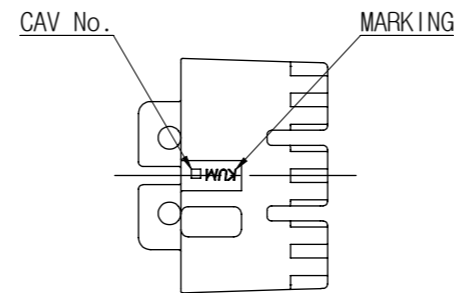
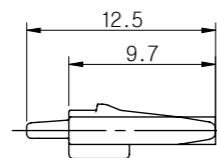
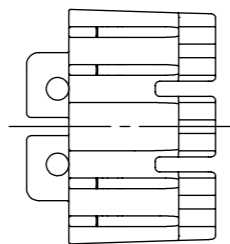
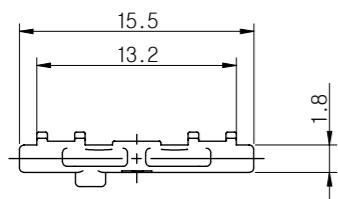

△ B

NO.	PART NAME	PART No.	COLOR	MATERIAL
③	AWPO3M-GY	HP401-03120	GRAY	PBT
②	F/H AWPO3M-L	HP411-03040	BLUE	PBT
①	AWPO3M-B	HP401-03020	BLACK	PBT

승인	DATE	NOTE No.	SYM	ALTERATION	담당
CJW	18.04.19	-	△ C	금도금 단자 사양 추가	LDH
CJW	17.04.25	E017-0179	△ B	GRAY 색상 추가	LDH
CJW	16.09.28	E016-0358	△ A	단자 덜 체결 검출 기능 추가	LDH
CJW	11.05.06	E010-0250	△ -	신 규	LSH

GENERAL TOLERANCE

	10MAX	50MAX	100MAX	150MAX	200MAX	200VR	ANGLE
A	±0.2	±0.3	±0.5	±0.8	±1.0	±1.4	±30'

THIRD ANGLE PROJECTION	A	1/1	LSH	LSH	KNJ	CJW
	TOLERANCE	SCALE	DESIGN	DRAWN	CHECKED	APPROVED

KUM 케이유엠

X-ON Electronics

Largest Supplier of Electrical and Electronic Components

Click to view similar products for [Terminal Block Tools & Accessories](#) category:

Click to view products by [KUM](#) manufacturer:

Other Similar products are found below :

[1029563](#) [00171430102](#) [00171420102](#) [014415](#) [CSTSPC1-2](#) [9-1437653-4](#) [928358-1](#) [QC209/J](#) [HCL10-6](#) [1437403-6](#) [1437403-9](#) [1437403-8](#)
[147832-1](#) [EC0037-000](#) [MT2/H--](#) [MT2/H-32](#) [MT6/H-N](#) [MT6/V-GRND](#) [MT8/H-101-110](#) [BB2-09BF](#) [EP2.5/4UN/BG](#) [1707755](#) [1735590](#)
[1755480](#) [1760336](#) [BO3-02](#) [1789281](#) [1840227](#) [1840230](#) [1893164](#) [2-1437402-1](#) [2-1437644-9](#) [JB2-09/J](#) [2202307](#) [2204082](#) [2302463](#) [2305949](#)
[2310581](#) [8TK2-24](#) [91.201.1](#) [L2U2](#) [2778.0](#) [2901107](#) [2901123](#) [2901699](#) [2MP/J](#) [2MV-06](#) [1705126](#) [F03-25](#) [1810532](#)