

规格承认书

SPECIFICATION FOR APPROVAL

客 户
CUSTOMER NAME : 立创商城

项 目 TYPE:MPP (MPP)
DESCRIPTION : METALLIZED POLYPROPYLENE FILM
CAPACITOR DC APPLICATION (RADIAL TYPE)

客 户 料 号
CUSTOMER' S P/N : 金属化聚丙烯薄膜电容器

鸿 志 料 号
HEL' S P/N :

※This specification will be invalidated assuming that it is not accepted when it is not returned with one year from the date of issue

CUSTOMER		HEL	
APPROVAL	PREPARE	APPROVAL	PREPARE
		林意杰	

HEL

HONG ZHI ENTERPRISE CO

ADD: N6,Pujiang Rd,Longhu Industrial Park, Shantou,Guangdong, China
TEL: 0754-88788046 88857416 FAX: 0754-88888417

ADD: Unit 10,11/F,BlkA, Hbil Luan Industrial Center ,55HibiYuanRoad,KwanTong
TEL: 0852-23412900 FAX: 0852-27903481

PLASTIC FILM CAPACITORS

TYPE: MPP

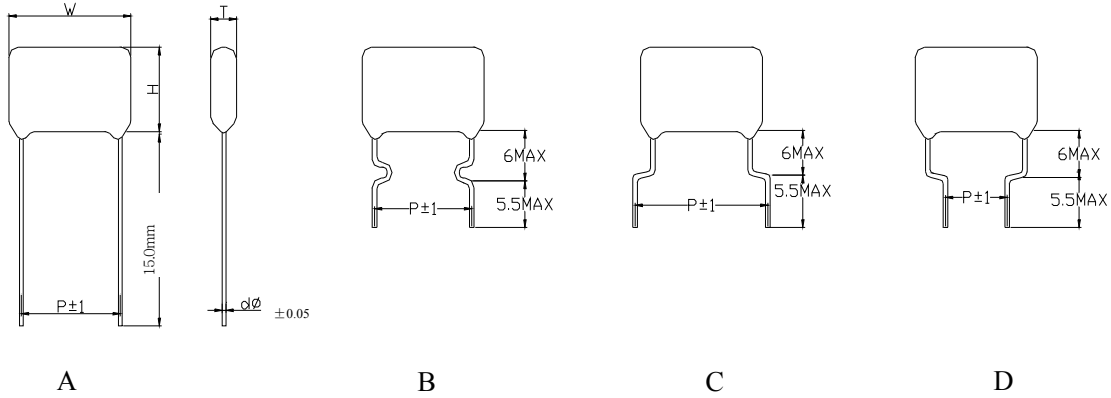

CUSTOMER P / N	CAP (µ F)	CAP TOL ±%	RATED VOLTAGE (VDC)	1KHZ DF(%) MAX	DIMENSION (mm)					HongZhi P/N	Fig
					Wmax	Hmax	Tmax	P	Ød		
C333838	0.1	5	100	0.1	7.2	6.5	2.5	5.0	0.5	MEM104J2A-7-50R0	A
C333827	0.1	5	100	0.1	7.2	7.0	4.0	5.0	0.5	MES104J2A-7-50R0	A
C333829	1	5	100	0.1	7.2	12.0	6.0	5.0	0.5	MES105J2A-7-50R0	A
C333834	0.1	5	400	0.1	13.0	9.0	6.0	10.0	0.6	MPP104J2GA3A0R0	A
C333835	1	5	400	0.1	18.0	10.0	8.0	15.0	0.7	MPP105J2GA8A50R0	A

2. SPECIFICATIONS:

1. OPERATING TEMPERATURE: $-40^{\circ}\text{C}\sim+105^{\circ}\text{C}$
2. CAPACITANCE RANGE: $0.001\mu\text{F}\sim 3.3\mu\text{F}$
3. CAPACITANCE TOLERANCE: $\pm 5\%$ (J), $\pm 10\%$ (K), $\pm 20\%$ (M)
4. RATED VOLTAGE: 100/160VDC(70VAC), 250VDC(140VAC), 400VDC(200VAC), 630VDC(220VAC), 1000/1250VDC(250VAC)
5. DISSIPATION FACTOR: 0.1% MAX AT 1KHZ, 25°C
6. INSULATION RESISTANCE: $50000\text{ M}\Omega$ ($C\leq 0.33\mu\text{F}$); $>10000\text{ M}\Omega\cdot\mu\text{F}$ ($C>0.33\mu\text{F}$) (measured at 100Vdc 1minute)
7. MAX. Pulse rise time (dv/dt) :

V _R (ac)	Lead spacing					
	7.5mm	10mm	15mm	22.5mm	27.5mm	31mm
100/160	250	200	150	100	80	
250	400	300	200	125	100	
400	500	400	300	180	130	
630	600	500	400	250		
1000/1250			500	300	200	

3. PERFORMANCE

Test Characteristics	Test Methods JIS C 5102	Performance
Withstand voltage: Between terminals	Apply 2.0 times of rated voltage for 2 sec. charge discharge current must be 10mA	Shall be no abnormality
Withstand voltage: Between terminals	Apply 2.0 times of rated voltage for 1 to 5 sec	Shall be no abnormality
Insulation resistance: Between terminals	Apply rated voltage $\pm 15\%$ for 60 sec. when rated voltage under 100V. Apply 100V $\pm 15\%$ when rated voltage from 100V to 500V at 20°C	$\leq 0.33\mu\text{F} \cong 30,000\text{M}\Omega$ (2E, 2G, 2J) $> 9000\text{ M}\Omega$ (2C)
Insulation resistance: Between terminals & enclosure	from 100V to 500V at 20°C	$> 0.33\mu\text{F} \cong 10,000\text{M}\Omega\cdot\mu\text{F}$ (2E, 2G, 2J)
Heat proof: Insulation resistance at 85°C	Testing temperature: $85\pm 2^{\circ}\text{C}$.	$\leq 0.33\mu\text{F} \cong 900\text{M}\Omega$ at 85°C
Heat proof: Rate of variation of capacitance at 85°C		$> 0.33\mu\text{F} \cong 300\text{M}\Omega\cdot\mu\text{F}$ at 85°C
Humidity test: Appearance	Temperature: $40\pm 2^{\circ}\text{C}$; Humidity: 90-95% RH	Shall be no abnormality
Humidity test: Withstand voltage	+24	Shall be no abnormality
Humidity test: Insulation resistance	Testing time: 500 - 0 Hrs. Apply voltage: rated voltage. After testing, leave it for about 16 Hrs. at standard condition	$\leq 0.33\mu\text{F} \cong 2700\text{M}\Omega$ $> 0.33\mu\text{F} \cong 900\text{M}\Omega\cdot\mu\text{F}$
Humidity test: Dissipation factor	Withstand voltage is 130% rated voltage, 60	0.011 (1.1%) Max.
Humidity test: Rate of variation capacitance		Within $\pm 10\%$ of the value before test
Reference Standard	GB/T 14579 (IEC 60384-17; IEC 60384-16) / JIS C 5102	

4. MEASURING & TESTING EQUIPMENTS:

1. Capacitance and Dissipation Factor ($\tan \delta$)
 - a. Hewlett Packard 4284A Precision LCR Meter;
 - b. NF 2322 LCR Meter;
 - c. Chen Hwa 104 LCR Meter.
2. Insulation Resistance:
 - a. Hewlett Packard 4329A High Resistance Meter;
 - b. TOA SM-8205 Super Megohm Meter.
3. Environmental Test Chamer:
 - a. King Son THS-A4L;
 - b. C Sun Hcc-2;
 - c. Tabai PR-1.
4. Dielectric Strength Test:

Good will GPT-515AD Puncture tester.

5. Construction

1. Tinned copper wire leads
2. Metal spray
3. Metallized polypropylene film dielectric,
4. Epoxy resin coating.

6. MARKING :

1. The trade mark of HONGZHI ELECTRONIC LTD.
2. Norminal capacitance in nF;
3. Capacitance tolerance.
4. Type of material(MPP: (Metallized Polypropylene Film).
5. DC rated voltage

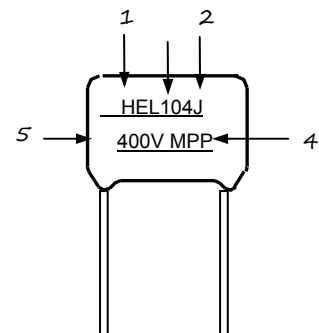
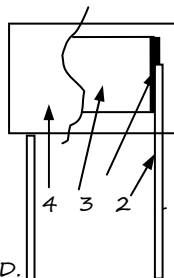

7. LEAD TAPING AND PACKAGING OF RADIAL COMPONENTS FOR ROBOT INSERTION MACHINES

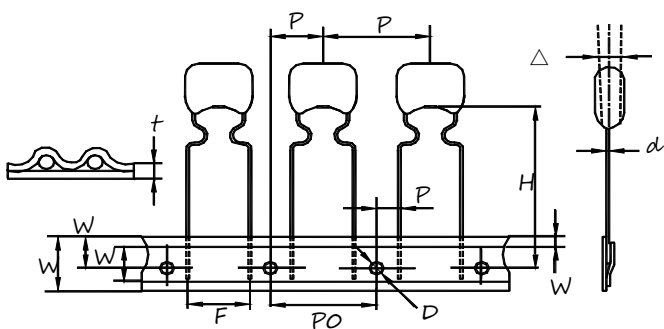

Fig. 1 Pitch=5 and

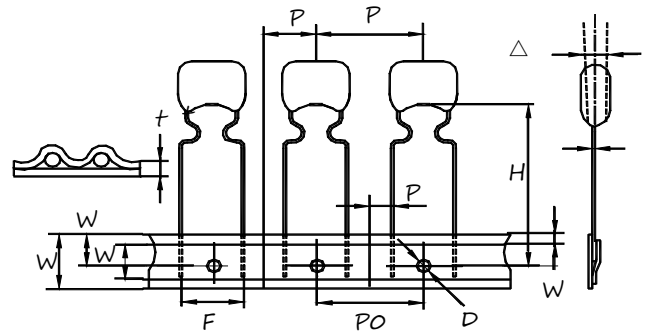

Fig. 2 Pitch=

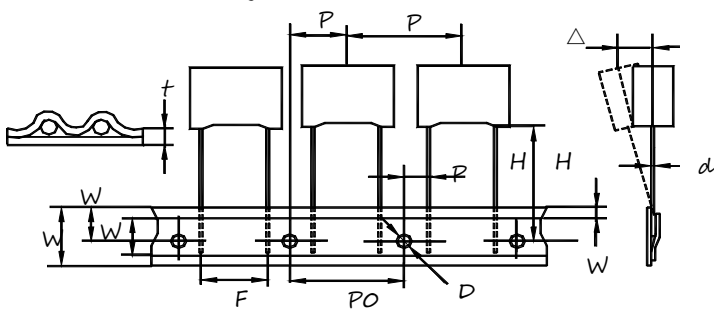

Fig. 1 Pitch=5 and

7.5mm

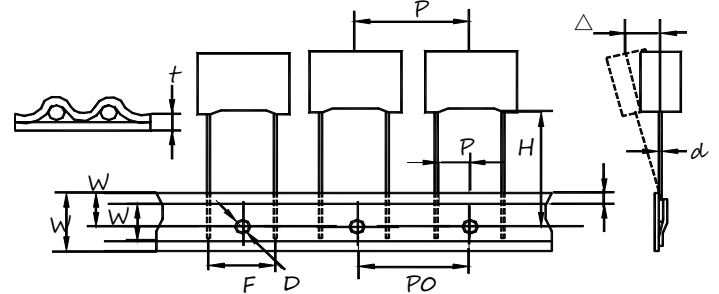

Fig. 2 Pitch=

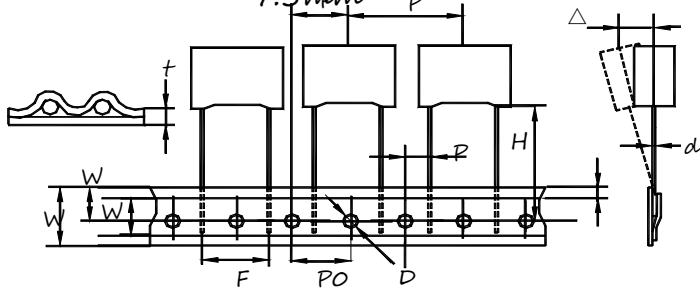

Fig. 3 Pitch=10 and

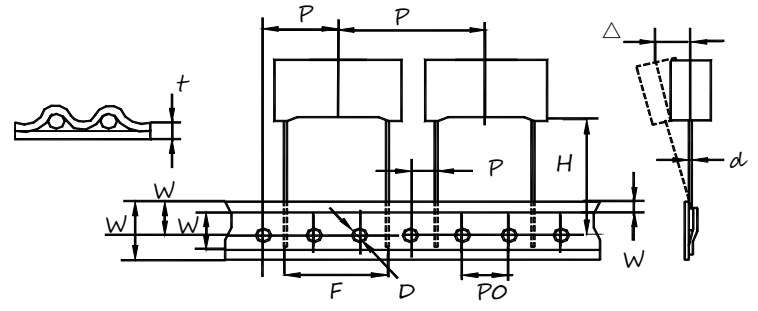

Fig. 4 Pitch=22.5 and

Description	Letter	Dimension (mm)						Tol.
		Fig. 1 P=5mm	Fig.1/ P=7.5mm	Fig.3 P=10mm	Fig.3 P=15mm	Fig.4 P=22.5mm	Fig.4 P=27.5mm	
Lead wire diameter	d	0.5/0.6	0.5/0.6	0.6	0.6/0.8	0.8	0.8	±0.05
Taping pitch	P	12.7	12.7	25.4	25.4	38.1	38.1	±1
Feed hole pitch	PO	12.7	12.7	12.7	12.7	12.7	12.7	±0.2
Centering of the lead	P1	3.85	2.6/3.75	7.7	5.2	7.8	5.3	±0.7
Centering of the body	P2	6.35	6.35	12.7	12.7	19.05	19.05	±1.3
Lead spacing (pitch)	F	5	7.5	10	15	22.5	27.5	+0.6;
Component	Δh	0	0	0	0	0	0	±2
Height of component	H	18.5	18.5	18.5	18.5	18.5	18.5	±0.5
Carrier tape width	W	18	18	18	18	18	18	+1; -0.5
Hold down tape	WO	6	6	9	10	10	10	min
Hole position	W1	9	9	9	9	9	9	±0.5
Hold down tape	W2	3	3	3	3	3	3	max
Feed hole diameter	Do	4	4	4	4	4	4	±0.2
Tape thickness	t	0.7	0.7	0.7	0.7	0.7	0.7	±0.2

Remark: *Allowance of accumulated pitch less than 1mm at the sum of 20 pitches.

*Continuous empty component less than 3 pcs.

*Total empty on one reel less than 1%.

8. PACKING SPECIFICATIONS

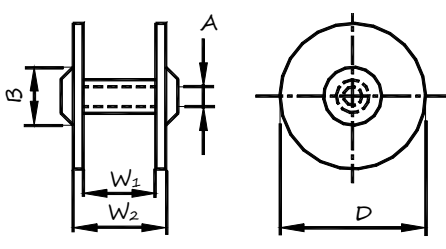
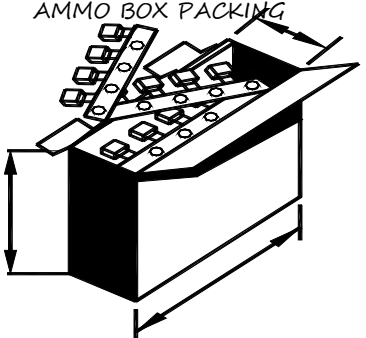
PACKING TYPE	REEL PACKING		AMMO BOX PACKING	
				
DIMENSIONS UNIT:MM	A	14~30	A	50 ⁺⁵ ₋₂
	B	80 MIN	B	260±2
	D	370 MAX	C	330±2
	W1	45 ⁺⁵ ₋₂		
	W2	55MAX		
PACKING Q'TY PER REE/BOX	C≤0.022 1500 PCS	C>0.022 1000 PCS	C≤0.047 1500 PCS	C>0.047 1000 PCS

EIA STANDARD RS-296-D

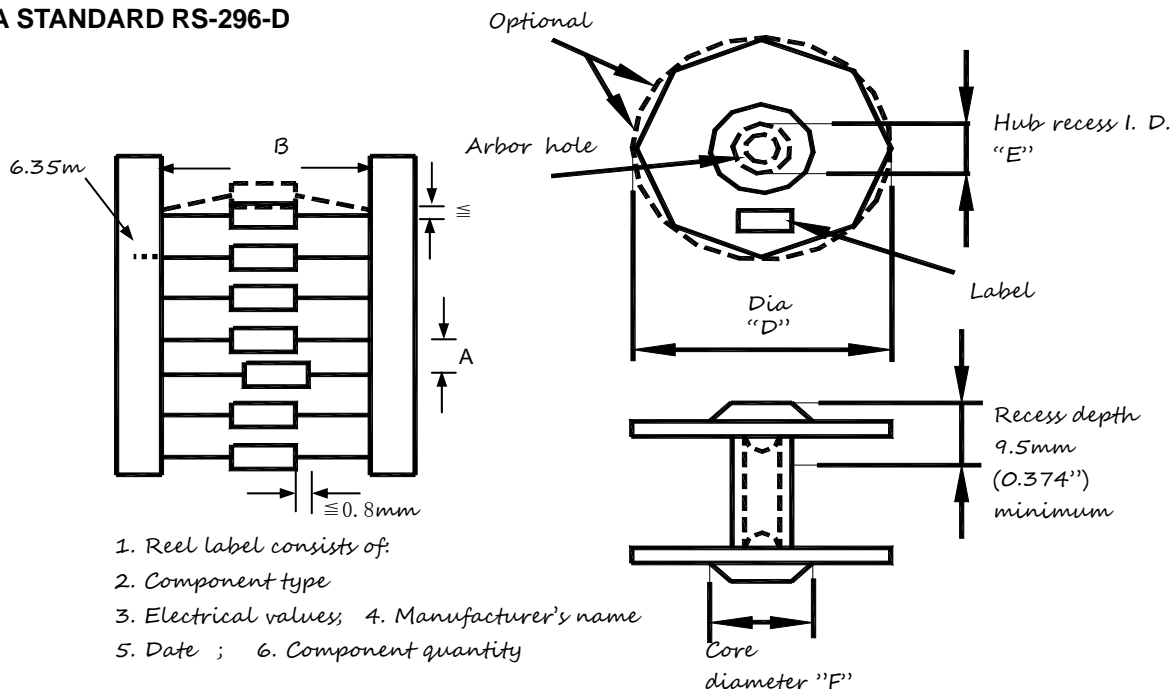

CAPACITOR BODY DIAMETER	CAPACITOR PITCH "A" ±0.5mm (0.020")
≅5mm (≅0.197")	5mm or 0.200"
5.01~10mm (0.197~0.394")	10mm or 0.400"
10.01~15mm (0.394~0.591")	15mm or 0.600"

CAPACITOR BODY LENGTH	INSIDE TAPE SPACING "B" ±1.5mm (0.059")
≅16.50mm (≅0.65")	52.44mm or 2.062"
16.51~28.45mm (0.651~1.12")	63.5mm or 2.500"
28.46~37.00mm (1.121~1.45")	76.0mm or 2.874"

	C	D	E	F
EIA Std.	13.9~38.1mm (0.54~1.50")	76.2~355.6mm (3.0~14.0")	28.6~78.0mm (1.126~3.071")	34.5~92.0mm (1.374~3.626")
RF Spec	14.50mm (0.570")	381.0mm (15")	54.2mm (2.130")	61.0mm (2.401")

CAPACITOR BODY DIA.	PITCH	QUANTITY PCS/REEL
≅5.0mm	6mm	4000 max
5.1~7.0mm	10mm	2000 max
7.1~9.5mm	10mm	1000 max

9. METALLIZED POLYPROPYLENE FILM CAPACITOR D.C. APPLICATION

■ Characteristics of voltage derating to frequency --- MPP

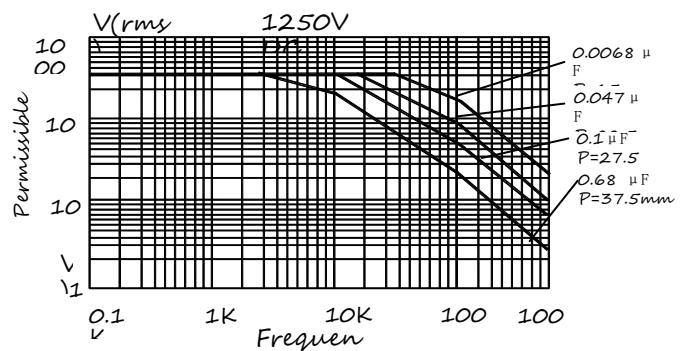
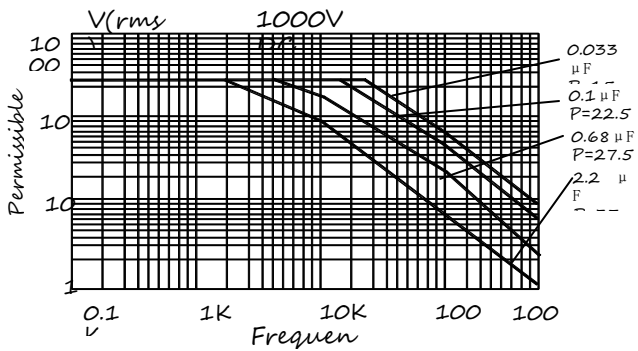
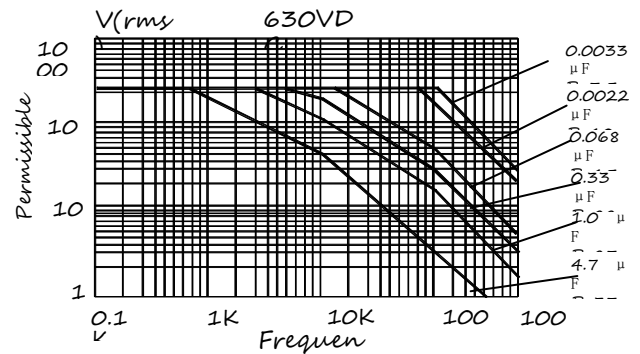
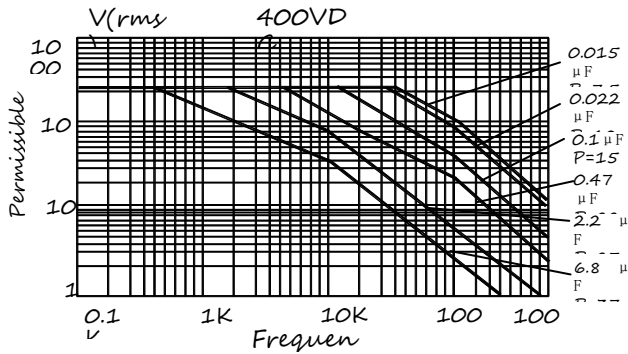
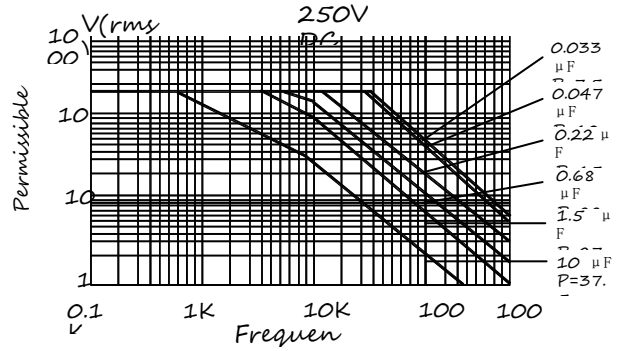
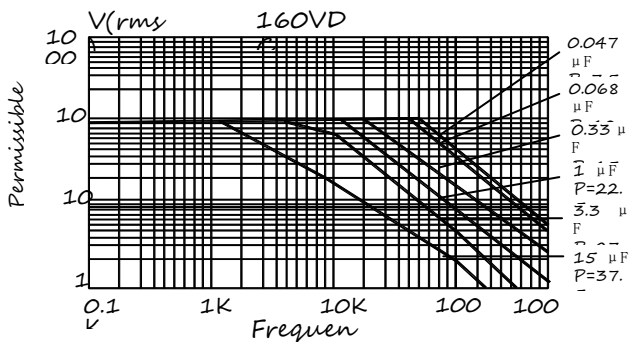

■ Characteristics of permissible current

Polypropylene Capacitor

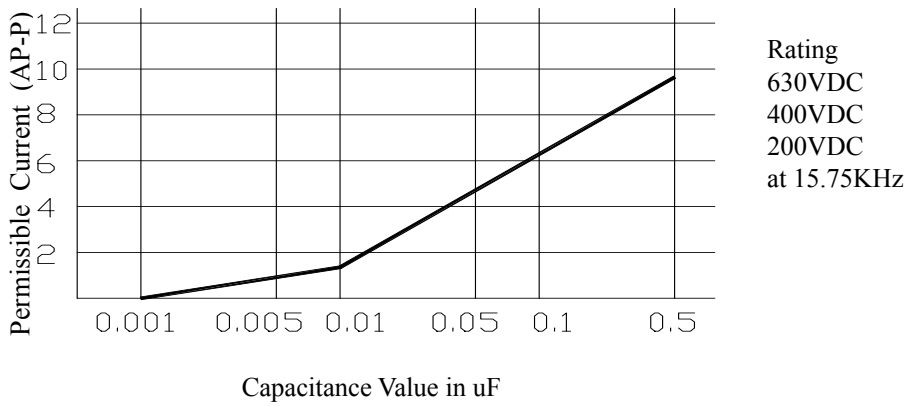

Metallized Polypropylene Capacitor

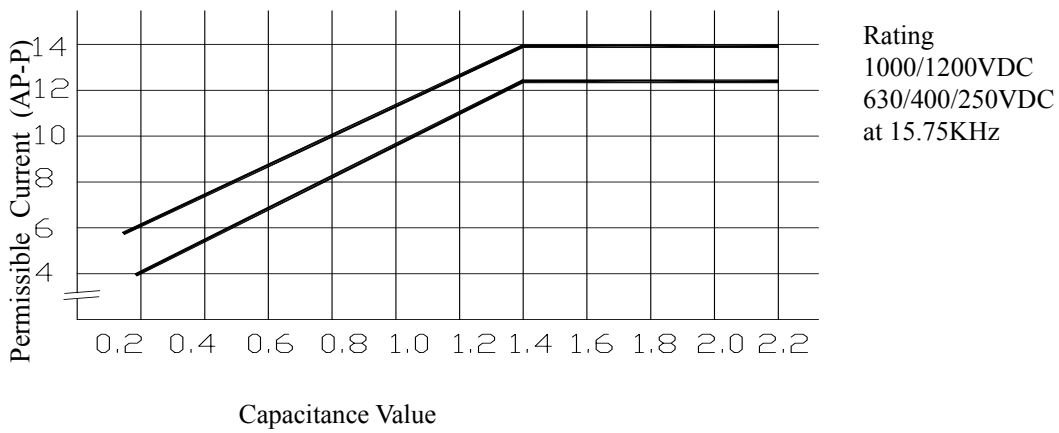

■ Capacitance 、 DF 、 Vrms and IR change as a function of temperature

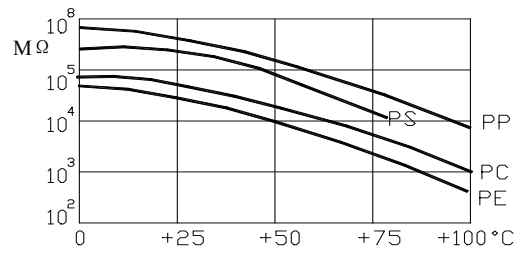
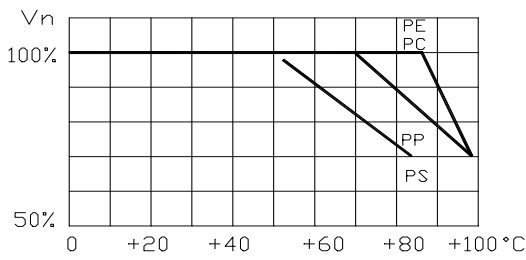
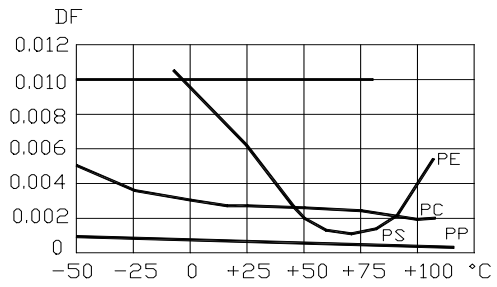
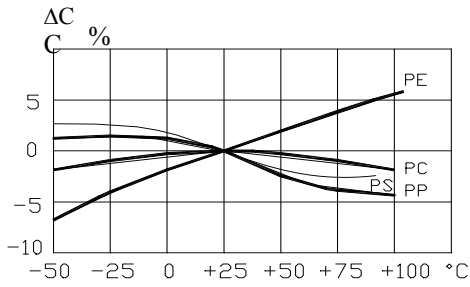

■ Soldering temperature versus time

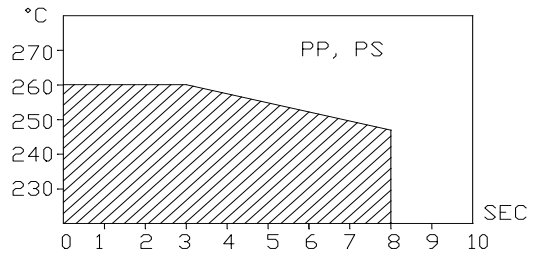
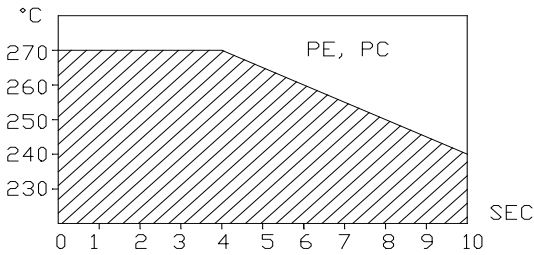

■ Capacitance and DF change as a function of frequency

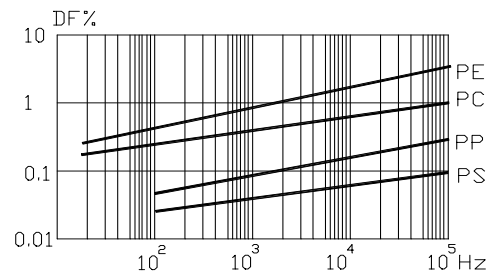
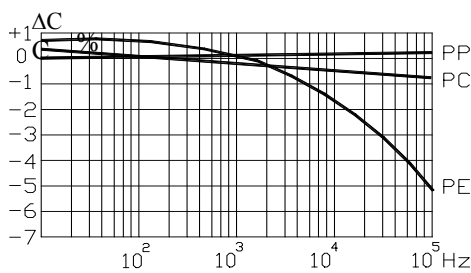

NOTE:

The graphs illustrated above are for reference only wave form of current and temperature rise of capacitor are key factors to determine permissible current. For actual applicant on. Consult our sales representative or sales office.

X-ON Electronics

Largest Supplier of Electrical and Electronic Components

Click to view similar products for [Film Capacitors](#) category:

Click to view products by [Hongzhi](#) manufacturer:

Other Similar products are found below :

[F339X134748MIP2T0](#) [F450KG153J250ALH0J](#) [750-1018](#) [FKP1-1500160010P15](#) [FKP1R031007D00JYSD](#) [FKP1R031507E00JYSD](#)
[FKP1U024707E00KYSD](#) [82DC4100CK60J](#) [82EC1100DQ50K](#) [PFR5101J100J11L16.5TA18](#) [PME261JB5220KR19T0](#) [A451GK223M040A](#)
[A561ED221M450A](#) [QXJ2E474KTPT](#) [QXL2B333KTPT](#) [R49AN347000A1K](#) [EEC2G505HQA406](#) [B25668A6676A375](#) [B25673A4282E140](#)
[BFC233868148](#) [BFC2370GC222](#) [C3B2AD44400B20K](#) [C4ASWBU3220A3EK](#) [CB027C0473J--](#) [CB177I0184J--](#) [CB182K0184J--](#) [23PW210](#)
[950CQW5H-F](#) [SBDC3470AA10J](#) [SCD105K122A3-22](#) [2N3155](#) [A571EH331M450A](#) [FKP1-2202KV5P15](#) [FKS3-680040010P10](#)
[QXL2E473KTPT](#) [445450-1](#) [B25669A3996J375](#) [46KI322000M1M](#) [46KR415050M1K](#) [4BSNBX4100ZBFJ](#) [MKP383510063JKP2T0](#)
[MKPY2-.02230020P15](#) [MKT 1813-368-015](#) [4055292001](#) [46KN410000N1K](#) [EEC2E106HQA405](#) [EEC2G205HQA402](#) [EEC2G805HQA415](#)
[P409CP224M250AH470](#) [82EC2150DQ50K](#)