

3A Low-Voltage Low-Dropout Regulator

FEATURES

- 3A minimum guaranteed output current
- 500mV typical dropout at 3A
- Ideal for 3.0V to 2.5V conversion
- Ideal for 2.5V to 1.8V or 1.5V conversion
- 1% initial accuracy
- Low ground current
- Current limiting and thermal shutdown
- Reversed-battery protection
- Reversed-leakage protection
- Fast transient response
- TTL/CMOS compatible enable pin => MIC39301
- Error flag output – MIC39301 only
- Adjustable version – MIC39302 only
- TO-263 and TO-220 packaging
- Moisture Sensitivity Level 3

TO263-3L / TO220-3L
(MIC39300-x.x Fixed only)

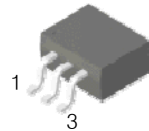

1. In
2. Gnd
3. Out

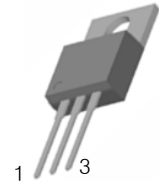

TO263-5L / TO220-5L
(MIC39301-x.x & MIC39302 only)

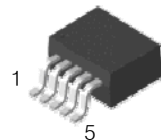

1. En
2. In
3. Gnd
4. Out
5. Flg or Adj

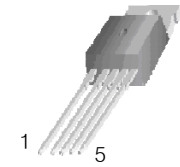

APPLICATIONS

- LDO linear regulator for PC add-in cards
- High-efficiency linear power supplies
- Multimedia and PC processor supplies
- SMPS post regulator
- Low-voltage microcontrollers
- StrongARM™ processor supply

DESCRIPTION

The MIC39300, MIC39301 and MIC39302 are 3.0A low-dropout linear voltage regulators that provide a low voltage, high-current output with a minimum of external components.

The MIC39300/1 offers extremely low dropout (typically 400mV at 3.0A) and low ground current (typically 36mA at 3.0A).

The MIC39300/1/2 is ideal for PC add-in cards that need to convert from standard 5V or 3.3V down to new, lower core voltages. A guaranteed maximum dropout voltage of 500mV over all operating conditions allows the MIC39300/1/2 to provide 2.5V from a supply as low as 3V.

The MIC39300/1/2 also has fast transient response for heavy switching applications. The device requires only 47F of output capacitance to maintain stability and achieve fast transient response. The MIC39300/1 is fully protected with over current limiting, thermal shutdown, reversed-battery protection, reversed-leakage protection, and reversed-lead insertion. The MIC39301 offers a TTL-logic compatible enable pin and an error flag that indicates under voltage and over current conditions. Offered in fixed voltages, the MIC39300/1/2 comes in the TO-220 and TO-263 packages and is an ideal upgrade to older, NPN-based linear voltage regulators.

PIN DESCRIPTION

Enable (Input)	CMOS-compatible control input. Logic high = enable, logic low or open = Shutdown
IN	Supply (Input): +16V maximum supply
GND	Ground pin and TAB are internally connected.
OUT	Regulator Output
FLG	Flag (Output): Open-collector error flag output.
ADJ	Adjustment Input: Feedback input.

ORDERING INFORMATION

Device	Marking	Package
MIC39300S-X.X	MIC39300-X.X	TO-263
MIC39300T-X.X	MIC39300-X.X	TO-220
MIC39301S-X.X	MIC39301-X.X	TO-263
MIC39301T-X.X	MIC39301-X.X	TO-220
MIC39302S-Adj	MIC39302	TO-263
MIC39302T-Adj	MIC39302	TO-220

* X.X = Fixed Vout = 1.5V, 1.8V, 2.5V, 3.3V, 5.0V

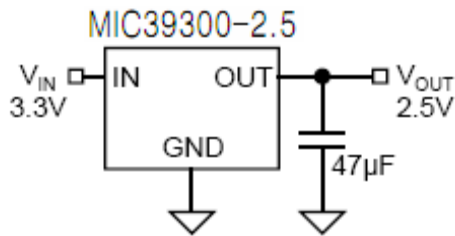
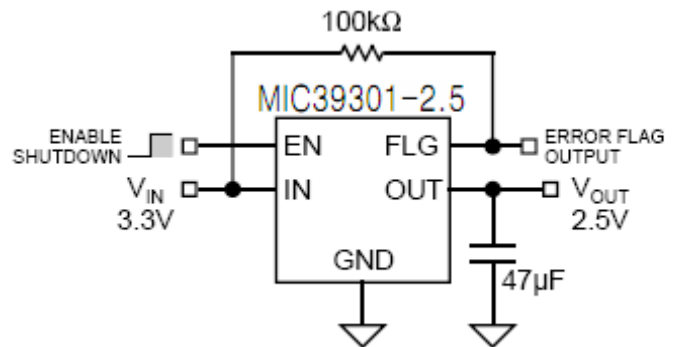
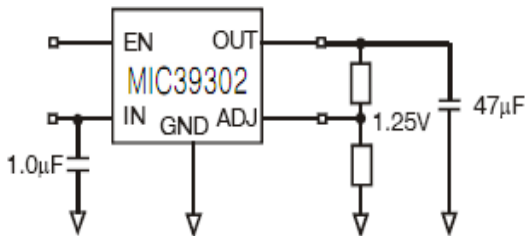
Typical Application Circuit

MIC39300

MIC39301

MIC39302
Absolute Maximum Ratings (Note 1)

Supply Voltage (V_{IN}) : -20V to +20V
 Enable Voltage (V_{EN}) : +20V
 Storage Temperature (T_S) : -65°C to +150°C
 Lead Temperature (soldering, 5 sec) : 260°C
 ESD, Note 3

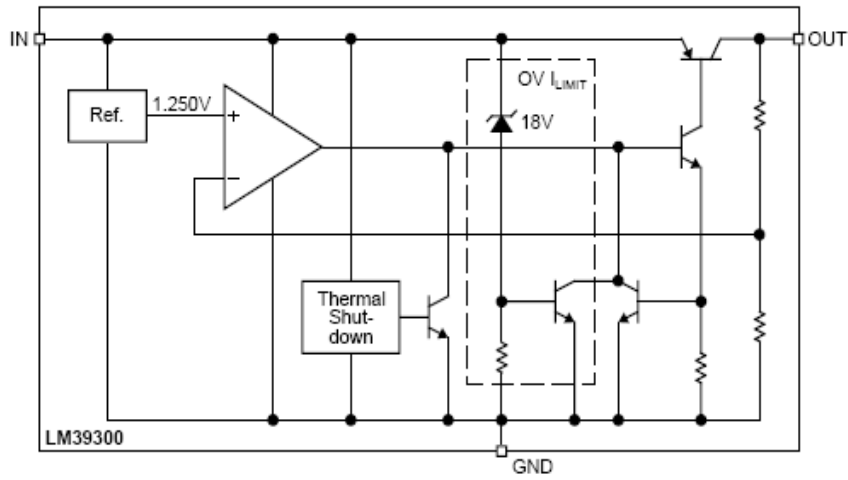
Operating Ratings (Note 2)

Supply Voltage (V_{IN}) : +2.25V to +16V
 Enable Voltage (V_{EN}) : +16V
 Maximum Power Dissipation ($P_{D(max)}$) Note 4
 Junction Temperature (T_J) : -40°C to +125°C
 Package Thermal Resistance
 TO-263(θ_{JC}) : 5°C/W
 TO-220(θ_{JC}) : 2°C/W

Block Diagram



MIC39300 Fixed (1.5V, 1.8V, 2.5V, 3.3V, 5.0V)

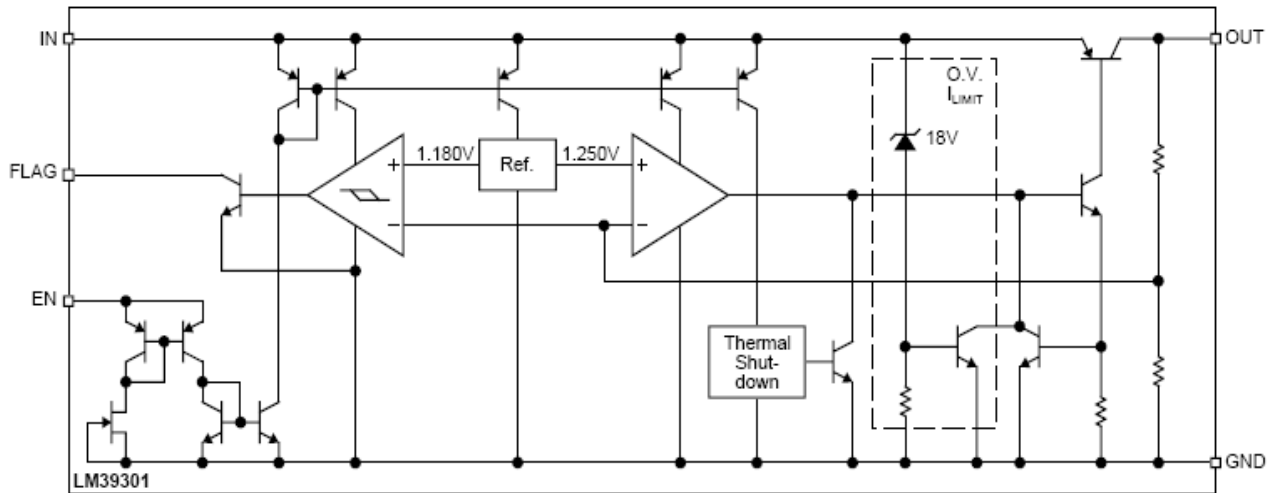

MIC39301 Fixed with flag and enable

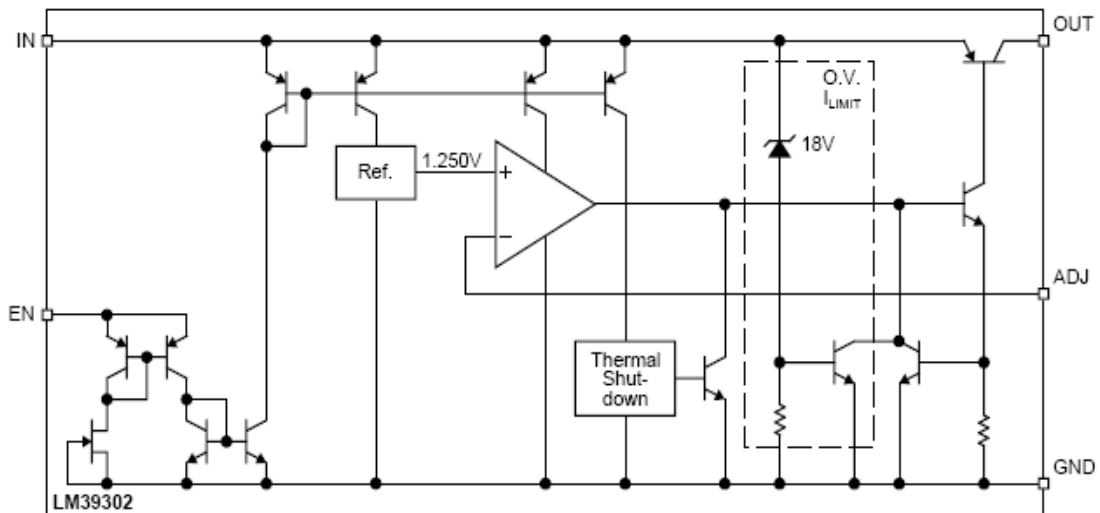

MIC39302 Adjustable

Electrical Characteristics
 $T_J = 25^\circ\text{C}$, **bold values indicate** $-40^\circ\text{C} \leq T_J \leq +125^\circ\text{C}$; unless noted

Symbol	Parameter	Condition	Min	Typ	Max	Units
V_{OUT}	Output Voltage	10mA	-1		1	%
		$10\text{mA} \leq I_{OUT} \leq 3\text{A}, V_{OUT} + 1\text{V} \leq V_{IN} \leq 8\text{V}$	-2		2	%
	Line Regulation	$I_{OUT} = 10\text{mA}, V_{OUT} + 1\text{V} \leq V_{IN} \leq 8\text{V}$		0.06	0.5	%
	Load Regulation	$V_{IN} = V_{OUT} + 1\text{V}, 10\text{mA} \leq I_{OUT} \leq 3\text{A}$		0.2	1	%
$\Delta V_{OUT}/\Delta T$	Output Voltage Temp. Coefficient, Note 5			20	100	ppm/ $^\circ\text{C}$
V_{DO}	Dropout Voltage, Note 6	$I_{OUT} = 100\text{mA}, \Delta V_{OUT} = -1\%$		80	200	mV
		$I_{OUT} = 750\text{mA}, \Delta V_{OUT} = -1\%$		200		mV
		$I_{OUT} = 1.5\text{A}, \Delta V_{OUT} = -1\%$		320		mV
		$I_{OUT} = 3\text{A}, \Delta V_{OUT} = -1\%$		400	550	mV
I_{GND}	Ground Current, Note 7	$I_{OUT} = 750\text{mA}, V_{IN} = V_{OUT} + 1\text{V}$		10	20	mA
		$I_{OUT} = 1.5\text{A}, V_{IN} = V_{OUT} + 1\text{V}$		17		mA
		$I_{OUT} = 3\text{A}, V_{IN} = V_{OUT} + 1\text{V}$		45		mA
$I_{GND(do)}$	Dropout Ground Pin Current	$V_{IN} \leq V_{OUT(nominal)} - 0.5\text{V}, I_{OUT} = 10\text{mA}$		6		mA
$I_{OUT(lim)}$	Current Limit	$V_{OUT} = 0\text{V}, V_{IN} = V_{OUT} + 1\text{V}$		4.5		A
Enable Output(MIC39301)						
V_{EN}	Enable Input Voltage	logic low (off)			0.8	V
		logic high (on)	2.25			V
I_{IN}	Enable Input Current	$V_{EN} = V_{IN}$		15	30 75	μA μA
		$V_{EN} = 0.8\text{V}$			2 4	μA μA
$I_{OUT(shdn)}$	Shutdown Output Current	Note 8		10	20	μA
Flag Output(MIC39301)						
$I_{FLG(leak)}$	Output Leakage Current	$V_{OH} = 16\text{V}$		0.01	1 2	μA μA
$V_{FLG(do)}$	Output Low Voltage	$V_{IN} = 2.250\text{V}, I_{OL} = 250\mu\text{A}, \text{Note 9}$		220	300 400	mV mV
V_{FLG}	Low Threshold	% of V_{OUT}	93			%
	High Threshold				99.2	%
	Hysteresis			1		%
MIC39302 Only						
	Reference Voltage	Note 10	1.238	1.250	1.262	V
			1.225		1.275	V
			1.213		1.277	V
	Adjust Pin Bias Current			40	80 120	nA nA
	Reference Voltage Temp. Coefficient	Note 7		20		ppm/ $^\circ\text{C}$
	Adjust Pin Bias Current Temp. Coefficient			0.1		nA/ $^\circ\text{C}$

- Note 1. Exceeding the absolute maximum ratings may damage the device.
 Note 2. The device is not guaranteed to function outside its operating rating.
 Note 3. Devices are ESD sensitive. Handling precautions recommended.
 Note 4. $P_{D(max)} = (T_{J(max)} - T_A) \theta_{JA}$, where θ_{JA} depends upon the printed circuit layout. See “Applications Information.”
 Note 5. V_{out} temperature coefficient is $\Delta V_{OUT(worst\ case)} / (T_{J(max)} - T_{J(min)})$ where $T_{J(max)}$ is +125°C and $T_{J(min)}$ is 0°C
 Note 6. $V_{DO} = V_{IN} - V_{OUT}$ when V_{OUT} decreases to 99% of its nominal output voltage with $V_{IN} = V_{OUT} + 1V$.
 Note 7. I_{GND} is the quiescent current. $I_{IN} = I_{GND} + I_{OUT}$.
 Note 8. $V_{EN} = 0.8V$, $V_{IN} = 8V$, and $V_{OUT} = 0V$
 Note 9. For a 2.5V device, $V_{IN} = 2.250V$ (device is in dropout).
 Note 10. $V_{REF} \leq V_{OUT} \leq (V_{IN} - 1V)$, $2.25V \leq V_{IN} \leq 16V$, $10mA \leq I_L \leq 3A$, $T_J = T_{MAX}$.

TYPICAL PERFORMANCE CHARACTERISTICS

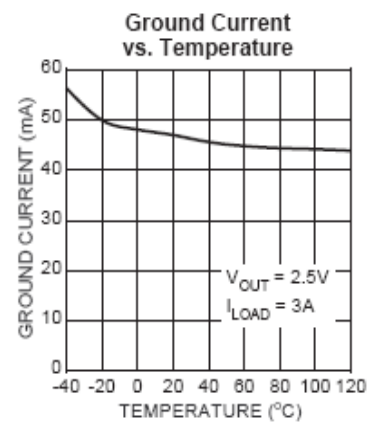
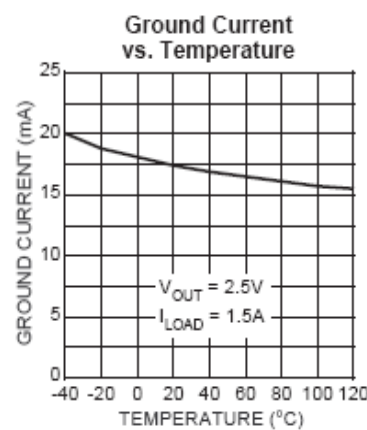
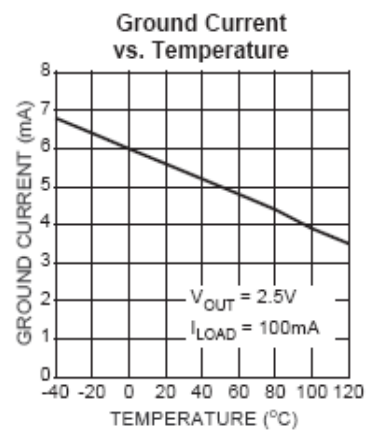
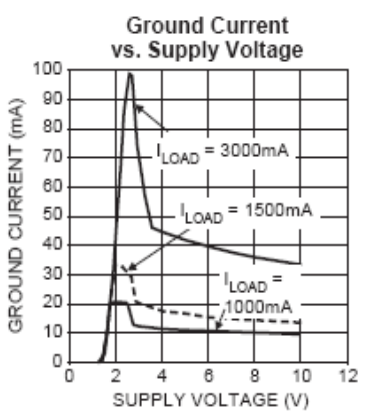
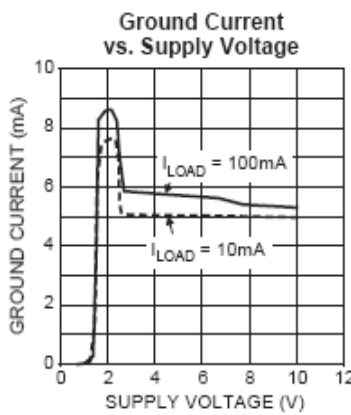
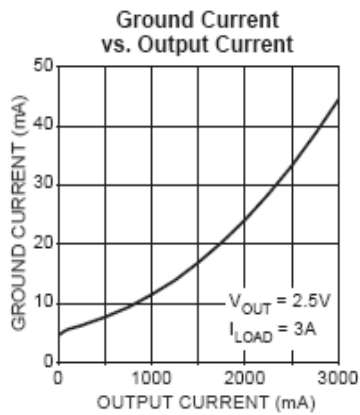
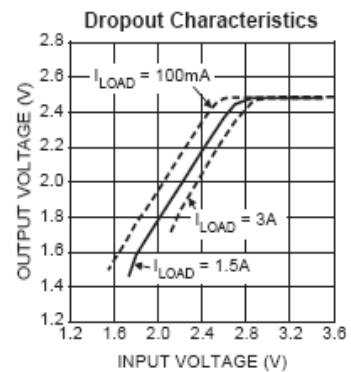
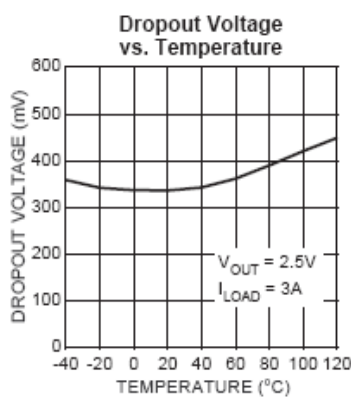
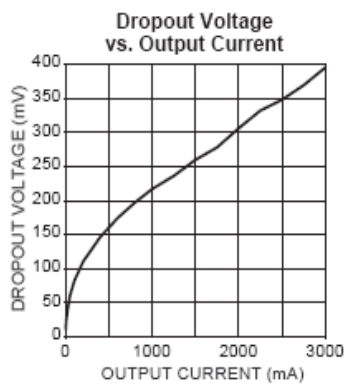

Short Circuit vs. Temperature

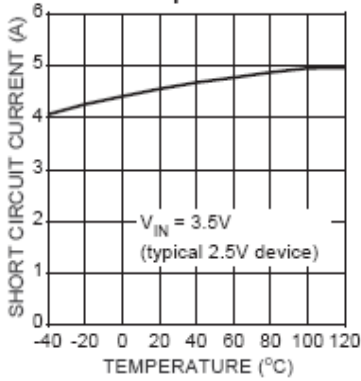

Output Voltage vs. Temperature

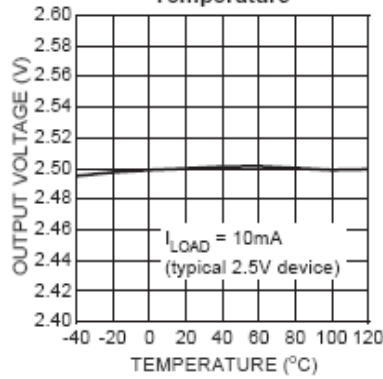

Enable Current vs. Temperature

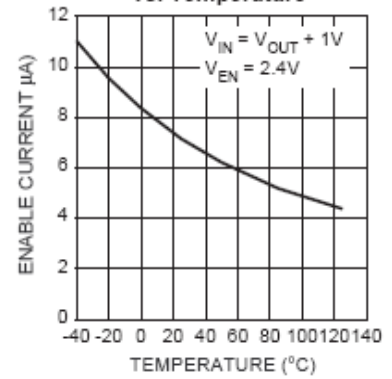

Flag-Low Voltage vs. Temperature

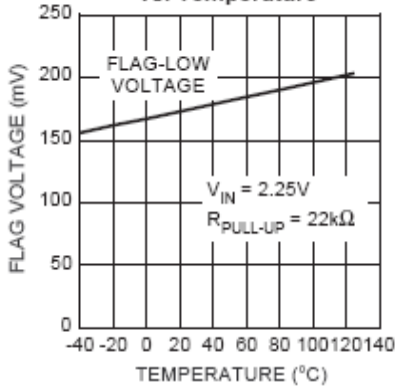

Power Supply vs. Ripple Rejection

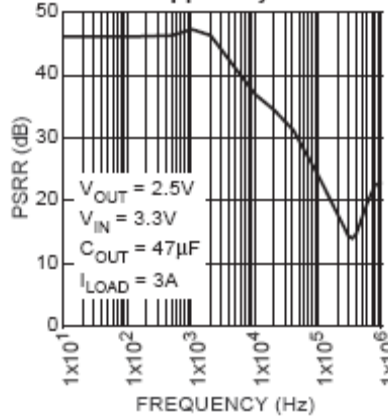

Power Supply vs. Ripple Rejection

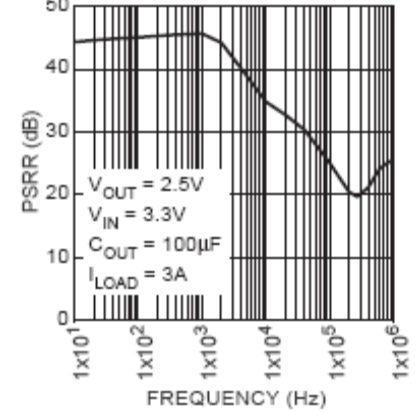

Error Flag Pull-Up Resistor

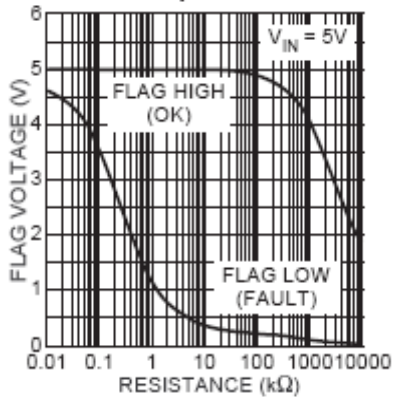

Line Transient Response

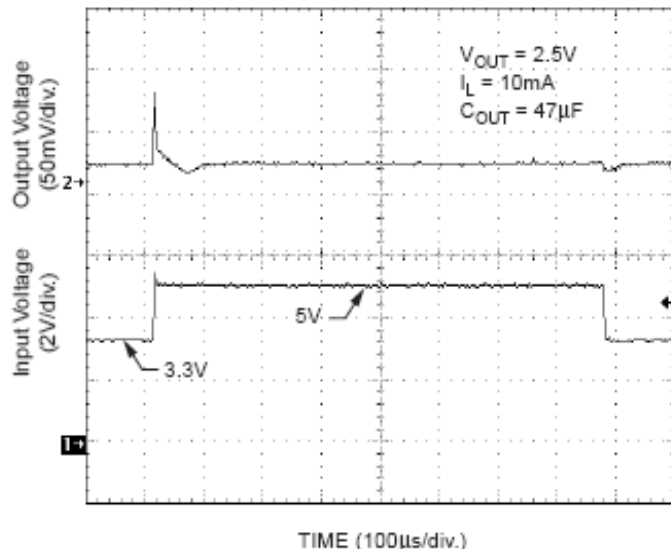

APPLICATION INFORMATION

The MIC39300/1 is a high-performance low-dropout voltage regulator suitable for moderate to high-current voltage regulator applications. Its 500mV dropout voltage at full load makes it especially valuable in battery-powered systems and as a high-efficiency noise filter in post-regulator applications. Unlike older NPN-pass transistor designs, where the minimum dropout voltage is limited by the base-to-emitter voltage drop and collector-to-emitter saturation voltage, dropout performance of the PNP output of these devices is limited only by the low V_{CE} saturation voltage. A trade-off for the low dropout voltage is a varying base drive requirement. The MIC39300/1/2 regulator is fully protected from damage due to fault conditions. Current limiting is provided. This limiting is linear output current during overload conditions is constant. Thermal shutdown disables the device when the die temperature exceeds the maximum safe operating temperature. Transient protection allows device (and load) survival even when the input voltage spikes above and below nominal. The output structure of these regulators allows voltages in excess of the desired output voltage to be applied without reverse current flow.

Thermal Design

Linear regulators are simple to use. The most complicated design parameters to consider are thermal characteristics. Thermal design requires four application-specific parameters:

- Maximum ambient temperature (T_A)
- Output Current (I_{OUT})
- Output Voltage (V_{OUT})
- Input Voltage (V_{IN})
- Ground Current (I_{GND})

Calculate the power dissipation of the regulator from these numbers and the device parameters from this datasheet, where the ground current is taken from the data sheet.

$$PD = (V_{IN} - V_{OUT}) I_{OUT} + V_{IN} I_{GND}$$

The heat sink thermal resistance is determined by:

$$\theta_{SA} = (T_{JMAX} - T_A) / PD - (\theta_{JC} + \theta_{CS})$$

where T_J (max) 125 °C and θ_{CS} is between 0°C and 2°C/W.

The heat sink may be significantly reduced in applications where the minimum input voltage is known and is large compared with the dropout voltage. Use a series input resistor to drop excessive voltage and distribute the heat between this resistor and the regulator. The low dropout properties of Taejin regulators allow significant reductions in regulator power dissipation and the associated heat sink without compromising performance. When this technique is employed, a capacitor of at least 1.0F is needed directly between the input and regulator ground. Refer to Application Note 9 for further details and examples on thermal design and heat sink specification.

Output Capacitor

The MIC39300/1/2 requires an output capacitor to maintain stability and improve transient response. Proper capacitor selection is important to ensure proper operation. The MIC39300/1/2 output capacitor selection is dependent upon the ESR (equivalent series resistance) of the output capacitor to maintain stability. When the output capacitor is 47F or greater, the output capacitor should have less than 1 of ESR. This will improve transient response as well as promote stability. Ultralow ESR capacitors, such as ceramic chip capacitors may promote instability. These very low ESR levels may cause an oscillation and/or underdamped transient response. A low-ESR solid tantalum capacitor works extremely well and provides good transient response and stability over temperature. Aluminum electrolytics can also be used, as long as the ESR of the capacitor is < 1. The value of the output capacitor can be increased without limit. Higher capacitance values help to improve transient response and ripple rejection and reduce output noise.

Input Capacitor

An input capacitor of 1F or greater is recommended when the device is more than 4 inches away from the bulk ac supply capacitance, or when the supply is a battery. Small, surface-mount, ceramic chip capacitors can be used for the bypassing. Larger values will help to improve ripple rejection by bypassing the input to the regulator, further improving the integrity of the output voltage. Transient Response and 3.3V.

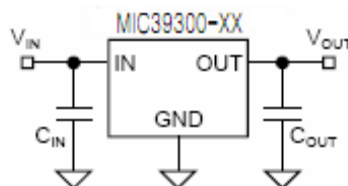

Fig 1. Capacitor Requirements

Minimum Load Current

The MIC39300/1/2 regulator is specified between finite loads.

If the output current is too small, leakage currents dominate and the output voltage rises.

A 10mA minimum load current is necessary for proper regulation.

Transient Response and 3.3V to 2.5V Conversion

The MIC39300/1/2 has excellent transient response to variations in input voltage and load current. The device has been designed to respond quickly to load current variations and input voltage variations. Large output capacitors are not required to obtain this performance. A standard 47F output capacitor, preferably tantalum, is all that is required. Larger values help to improve performance even further. By virtue of its low-dropout voltage, this device does not saturate into dropout as readily as similar NPN-based designs. When converting from 3.3V to 2.5V, the NPN-based regulators are already operating in dropout, with typical dropout requirements of 1.2V or greater. To convert down to 2.5V without operating in dropout, NPN-based regulators require an input voltage of 3.7V at the very least. The MIC39300/1/2 regulator will provide excellent performance with an input as low as 3.0V. This gives the PNP-based regulators a distinct advantage over older, NPN-based linear regulators.

Error Flag

The MIC39301 version features an error flag circuit which monitors the output voltage and signals an error condition when the voltage drops 5% below the nominal output voltage. The error flag is an open-collector output that can sink 10mA during a fault condition. Low output voltage can be caused by a number of problems, including an overcurrent fault (device in current limit) or low input voltage. The flag is inoperative during overtemperature shutdown.

Enable Input

The MIC39301 version features an enable input for on/off control of the device. Its shutdown state draws “zero” current (only microamperes of leakage). The enable input is TTL/CMOS compatible for simple logic interface, but can be connected to up to 20V. When enabled, it draws approximately 15A.

Adjustable Regulator Design

The MIC39302 allows programming the output voltage anywhere between 1.25V and the 16V maximum operating rating of the family. Two resistors are used. Resistors can be quite large, up to 1M Ω , because of the very high input impedance and low bias current of the sense comparator: The resistor values are calculated by : $R1=R2(V_{out}/1.250-1)$

Where VO is the desired output voltage. Figure 1 shows component definition. Applications with widely varying load currents may scale the resistors to draw the minimum load current required for proper operation (see below).

X-ON Electronics

Largest Supplier of Electrical and Electronic Components

Click to view similar products for [LDO Voltage Regulators](#) category:

Click to view products by [HGSEMI](#) manufacturer:

Other Similar products are found below :

[M38D29FFHP#U1](#) [702103A](#) [717726C](#) [742457H](#) [MP20051DN-LF-Z](#) [R5F111PGGFB#30](#) [AP7363-SP-13](#) [NCP103AMX285TCG](#)
[NCV8664CST33T3G](#) [NCV8752AMX28TCG](#) [L9454](#) [AP7362-HA-7](#) [LX13043CLD](#) [TCR3DF185,LM\(CT](#) [TCR3DF24,LM\(CT](#)
[TCR3DF285,LM\(CT](#) [TCR3DF31,LM\(CT](#) [TCR3DF45,LM\(CT](#) [TLF4949EJ](#) [MP2013GQ-33-Z](#) [L9708](#) [L970813TR](#) [030014BB](#) [059985X](#)
[NCP121AMX173TCG](#) [NCP4687DH15T1G](#) [NCV8703MX30TCG](#) [701326R](#) [702087BB](#) [755078E](#) [TCR2EN28,LF\(S](#) [LM1117DT-1.8/NO](#)
[LT1086CM#TRPBF](#) [AZ1085S2-1.5TRE1](#) [MAX15101EWL+T](#) [NCV8170AXV250T2G](#) [SCD337BTG](#) [TCR3DF27,LM\(CT](#)
[TCR3DF19,LM\(CT](#) [TCR3DF125,LM\(CT](#) [MAX15103EWL+T](#) [TS2937CZ-5.0 C0](#) [MAX8878EUK30-T](#) [MAX663CPA](#) [NCV4269CPD50R2G](#)
[NCV8716MT30TBG](#) [AZ1117IH-1.2TRG1](#) [MP2013GQ-P](#) [AP2112R5A-3.3TRG1](#) [AP7315-25W5-7](#)