

# 承 認 書

## SPECIFICATION FOR APPROVAL

\*客戶名稱 : 立創  
**Customer name**

---

\*產品名稱 : 插座  
**Product Description**

---

\*產品型號 : RT-C08-H0-BJ  
**Product part number**

---

\*客戶料號 :  
**Customer's material number**

---

\*數量 : 0 PCS  
**Quantity**

---

\*日期 : 2019-6-27  
**Date**

---

供應商負責人簽名		客戶負責人確認簽回	
製作人	莫麗琴	承認人	
審核	李跃鑫	審核	
批准	王瑞宝	批准	

皓宇(香港)有限公司  
HAOYU (HONG KONG) LIMITED  
六均电子五金有限公司  
LEGION ELECTRONIC&HARDWARE CO., LTD  
富力隆电子(深圳)有限公司  
ROCKTEK ELECTRONICS (SHENZHEN) CO. LTD  
東莞市石碣鎮四村第一工業區  
Sicun 1st Industrial park, Sicun,  
Shijie Town, Dongguan

電話 : (86) 769-82310511-2  
Tel No

傳真 : (86) 769-82310510  
Fax No

郵箱 : [haoyu888@21cn.com](mailto:haoyu888@21cn.com)  
E - mail

核 准 :  
Approved

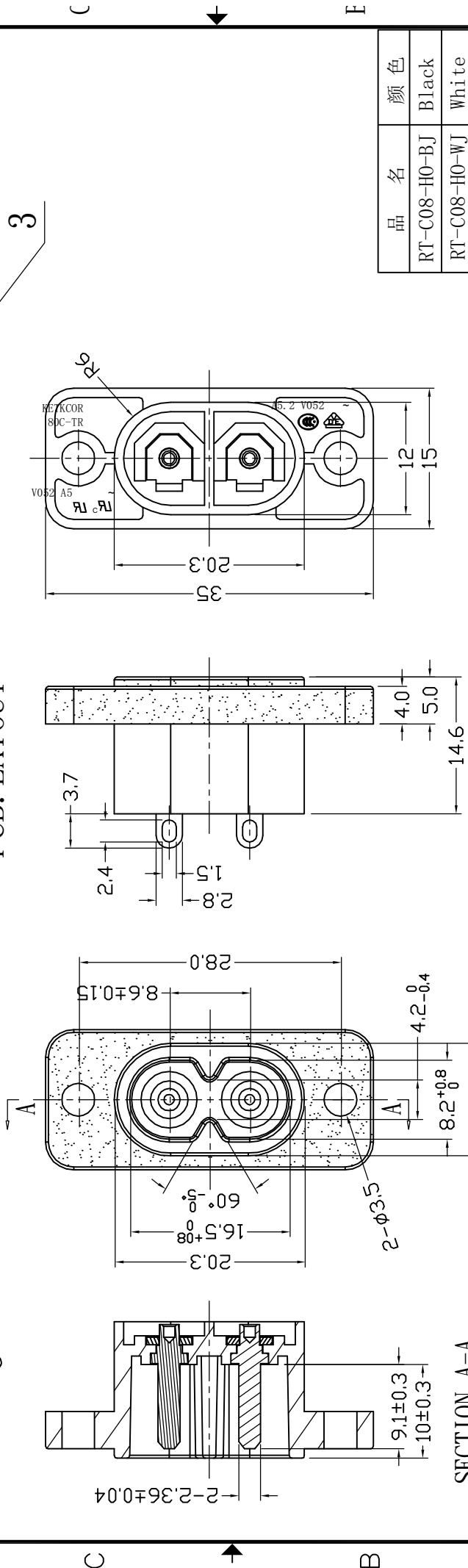
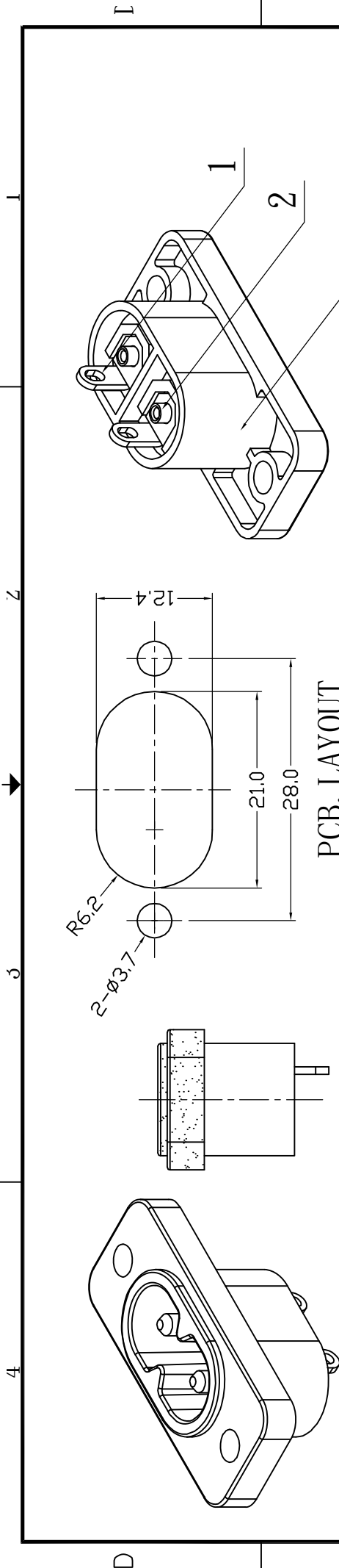

NOTES:

1. Rating : 2.5A 250VAC CCC VDE 5A 250VAC UL CUL
2. Contact resistance : 50mΩ Max
3. Insulation resistance : >100MΩ (Min) 500VDC
4. Dielectric strength : >2000VAC 0.5mA 1 minutes

NO	DESCRIPTION	NO	DESCRIPTION	DIMENSIONAL TOLERANCES				DESIGN	DRAWN	ALL SIZE ARE IN MM		
				RANGE	TOLERANCE	SCALE	FIT			MAT'L	MATERIAL NO.	DRAWING NO.
5	→	10	→	X	±0.3	LMC	LMC	2018.01.09	2018.01.09	RT-C08-H0-*J	*****	A
4	→	9	→	X.X	±0.2							
3	→	8	→	X.XX	±0.1							
2	→	7	→	ANGLES	±1°							
1	→	6	→									

NO.	PART NAME	MATERIAL	Q'TY
3	BODY	PA66 94-V0 Black	1
2	1# terminal	C2680 1/2H Tin-plating 3~5um	2
1	1# PIN	C3602 Ni-plating 3~5um	2

品名	颜色
RT-C08-H0-BJ	Black
RT-C08-H0-WJ	White

ROCK TEK ELECTRONIC(SHENZHEN) CO.,LTD.

1.Scope

This specification cover the RT-C08 AC socket.

2.Operation temperature

-10°C~85°C

3. Standard

IEC320-1

CSA22.2

EN60 320

UL498

4.Rating

2.5A 250VAC for VDE CCC

5A 250VAC for UL,CUL

5.Electrical

5.1. Contact resistance

Contact resistance should be 30mΩ(Max).

5.2. Insulation resistance

It is measured with 500V DC should be 1000MΩ(Min).

5.3. Dielectric strength

(Between terminals of open contacts and terminals of opposite polarity)

Dielectric strength should withstand without breakdown a potential of AC 2000V/minute.

(Between terminals and metal frame)

Dielectric strength should withstand without breakdown a potential of AC 2000V/minute.

**ROCK TEK ELECTRONICS(SHENZHEN) CO., LTD.**

**富力隆電子（深圳）有限公司**

**Specification Of RT-C08 AC Socket** page:2/2

6.Construction

6.1. Heat test

The socket should be putted in a hot chamber at temperature of  $100^{\circ}\text{C} \pm 5^{\circ}\text{C}/\text{hour}$ . The Socket should have the capability to satisfy the performance the paragraphs 5.1. , 5.2. , 5.3. , And the socket should show no evidence of cracking. Crazing and deformation.



6.2.Body strength

The socket should be press body with 8kg/minute.

The socket should have the capability to satisfy. the performance the paragraphs 5.1,5.2,5.3 and the socket should should no evidence of carching.

7.Paking:

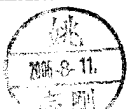
200PCS/bag ,2000PCS/CTN.

APPROVED	CHECK	WRITER	DESCRIPTION
		ALEX	YALE



## AXUT2.E300176 Attachment Plugs, Fuseless - Component

[Page Bottom](#)

---

### Attachment Plugs, Fuseless - Component

[See General Information for Attachment Plugs, Fuseless - Component](#)

**ROCK TEK ELECTRONICS INDUSTRY CORP**

E300176

98 GUANGUANG RD  
BAO'AN DISTRICT, GUANLAN TOWN  
SHENZHEN, GUANGDONG 518110 CHINA

**Appliance inlets**, Models RT-C06, RT-C08, RT-C14, RT-C14A.

Model RT-C05A.

Marking: Company name and catalog designation on device or carton.

[Last Updated](#) on 2011-05-19

---

[Questions?](#)

[Print this page](#)

[Terms of Use](#)

[Page Top](#)

◆ 2015 UL LLC

The appearance of a company's name or product in this database does not in itself assure that products so identified have been manufactured under UL's Follow-Up Service. Only those products bearing the UL Mark should be considered to be Certified and covered under UL's Follow-Up Service. Always look for the Mark on the product.

UL permits the reproduction of the material contained in the Online Certification Directory subject to the following conditions: 1. The Guide Information, Assemblies, Constructions, Designs, Systems, and/or Certifications (files) must be presented in their entirety and in a non-misleading manner, without any manipulation of the data (or drawings). 2. The statement "Reprinted from the Online Certifications Directory with permission from UL" must appear adjacent to the extracted material. In addition, the reprinted material must include a copyright notice in the following format: "© 2015 UL LLC".



**AXUT8.E300176**  
**Attachment Plugs, Fuseless Certified for Canada - Component**

[Page Bottom](#)

---

**Attachment Plugs, Fuseless Certified for Canada - Component**

[See General Information for Attachment Plugs, Fuseless Certified for Canada - Component](#)

**ROCK TEK ELECTRONICS INDUSTRY CORP**

E300176

98 GUANGUANG RD  
BAO'AN DISTRICT, GUANLAN TOWN  
SHENZHEN, GUANGDONG 518110 CHINA

**Appliance inlets**, Models RT-C06, RT-C08, RT-C14, RT-C14A.

Model RT-C05A.



Marking: Company name and catalog designation and Recognized Component Mark for Canada,  on device or carton.

[Last Updated](#) on 2011-05-19

---

[Questions?](#)

[Print this page](#)

[Terms of Use](#)

[Page Top](#)

◆ 2015 UL LLC

The appearance of a company's name or product in this database does not in itself assure that products so identified have been manufactured under UL's Follow-Up Service. Only those products bearing the UL Mark should be considered to be Certified and covered under UL's Follow-Up Service. Always look for the Mark on the product.

UL permits the reproduction of the material contained in the Online Certification Directory subject to the following conditions: 1. The Guide Information, Assemblies, Constructions, Designs, Systems, and/or Certifications (files) must be presented in their entirety and in a non-misleading manner, without any manipulation of the data (or drawings). 2. The statement "Reprinted from the Online Certifications Directory with permission from UL" must appear adjacent to the extracted material. In addition, the reprinted material must include a copyright notice in the following format: "© 2015 UL LLC".

# VDE Prüf- und Zertifizierungsinstitut

## ZEICHENGENEHMIGUNG MARKS APPROVAL

Rock Tek Electronics  
Industry Corporation  
No.64 Lane 11, Hua Cherng Road  
242 Hsin Chuang City, Taipei  
TAIWAN

ist berechtigt, für ihr Produkt /  
*is authorized to use for their product*

Gerätestecker  
*Appliance inlet*  
RT-C08

die hier abgebildeten markenrechtlich geschützten Zeichen  
für die ab Blatt 2 aufgeführten Typen zu benutzen /  
*the legally protected Marks as shown below for the types referred to on page 2 ff.*



Geprüft und zertifiziert nach /  
*Tested and certified according to*

DIN EN 60320-1 (VDE 0625 Teil 1):2002-06; EN 60320-1:2001

VDE Prüf- und Zertifizierungsinstitut  
*VDE Testing and Certification Institute*  
Zertifizierungsstelle / *Certification*

*Schipper*

VDE Zertifikate sind nur gültig bei Veröffentlichung unter:  
*VDE certificates are valid only when published on:*

Aktenzeichen: 5004989-1550-0002 / 74035

*File ref.:*

Ausweis-Nr. 40017855

Blatt 1

*Certificate No.*

Page

Weitere Bedingungen siehe Rückseite und Folgeblätter /  
*further conditions see overleaf and following pages*

Offenbach, 2006-05-31

<http://www.vde.com/zertifikat>

<http://www.vde.com/certificate>

VDE VERBAND DER ELEKTROTECHNIK  
ELEKTRONIK INFORMATIONSTECHNIK e.V.



# VDE Prüf- und Zertifizierungsinstitut Zeichengenehmigung

Ausweis-Nr. / Blatt /  
Certificate No. / page  
40017855 2

Name und Sitz des Genehmigungs-Inhabers / *Name and registered seat of the Certificate holder*  
Rock Tek Electronics Industry Corporation, No.64 Lane 11, Hua Cherng Road, 242 Hsin Chuang City,  
Taipei, TAIWAN

Aktenzeichen / *File ref.*  
5004989-1550-0002 / 74035 / FG33 / E

Datum / *Date*  
2006-05-31

Dieses Blatt gilt nur in Verbindung mit Blatt 1 des Zeichengenehmigungsausweises Nr. 40017855.  
*This supplement is only valid in conjunction with page 1 of the Certificate No. 40017855.*

## Gerätestecker *Appliance inlet* RT-C08

Typ(en) / *Type(s)*:

**RT-C08**

Bemessungsspannung <i>Rated voltage</i>	AC 250 V
Bemessungsstrom <i>Rated current</i>	2,5 A
Polzahl <i>Number of poles</i>	2-polig ohne Schutzkontakt <i>2-pole without earthing contact</i>
Bauart <i>Kind of construction</i>	Normblatt C8 <i>standard sheet C8</i>
Stifttemperatur <i>Temperature of the pins</i>	max. 70°C
Art der Montage <i>Method of mounting</i>	Einbau für Geräte der Schutzklasse II Einschubbefestigung <i>built into class II appliances</i> <i>insert mounting</i>
Anschlussart <i>Connection method</i>	Lötanschluß <i>solder terminals</i>
Isoliermaterial <i>Insulating material</i>	PC; Typ(e) 6485(f2); Bayer
Glühdrahtfestigkeit des Trägermaterials <i>Glow wire resistance</i>	850°C

Fortsetzung siehe Blatt 3 /  
*continued on page 3*





# VDE Prüf- und Zertifizierungsinstitut Zeichengenehmigung

Ausweis-Nr. / Blatt /  
Certificate No. page  
40017855 3

Name und Sitz des Genehmigungs-Inhabers / *Name and registered seat of the Certificate holder*  
Rock Tek Electronics Industry Corporation, No.64 Lane 11, Hua Cherng Road, 242 Hsin Chuang City,  
Taipei, TAIWAN

Aktenzeichen / *File ref.*  
5004989-1550-0002 / 74035 / FG33 / E

Datum / *Date*  
2006-05-31

Dieses Blatt gilt nur in Verbindung mit Blatt 1 des Zeichengenehmigungsausweises Nr. 40017855.  
*This supplement is only valid in conjunction with page 1 of the Certificate No. 40017855.*

Weitere Angaben  
*Further information*

siehe Anlage Nr. 600A  
*see Appendix No. 600A*

Dieser Zeichengenehmigungs-Ausweis bildet die Grundlage für die EG-Konformitätserklärung und CE-Kennzeichnung durch den Hersteller oder dessen Bevollmächtigten und bescheinigt die Konformität mit den genannten Normen im Sinne der **EG-Niederspannungsrichtlinie 73/23/EWG** mit ihren Änderungen.  
*This Marks Approval is the basis for the EC Declaration of Conformity and the CE Marking by the manufacturer or his agent and shows the conformity with the said standards as defined by the EC Low-Voltage Directive 73/23/EEC including amendments.*

VDE Prüf- und Zertifizierungsinstitut  
*VDE Testing and Certification Institute*  
Fachgebiet FG33  
*Section FG33*

i.A.  i.A. 

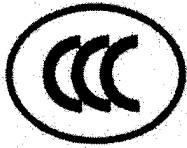

# 中国国家强制性产品认证证书

证书编号: 2006010204177702

## 申请人名称及地址

富力隆电子(深圳)有限公司  
深圳市宝安区观澜大水坑观光公路观澜镇大水坑桔新经济合作社

## 商标:

## 制造商名称及地址

富力隆电子(深圳)有限公司  
深圳市宝安区观澜大水坑观光公路观澜镇大水坑桔新经济合作社

## 生产企业名称及地址

富力隆电子(深圳)有限公司  
深圳市宝安区观澜大水坑观光公路观澜镇大水坑桔新经济合作社

## 产品名称和系列、规格、型号

用于冷条件下 II 类设备的 2.5A 250V 器具输入插座  
RT-C08 2.5A 250V ~

## 产品标准和技术要求

GB17465.1-1998

上述产品符合强制性产品认证实施规则的要求, 特发此证。

发证日期: 2006年3月31日

本证书的有效性依据发证机构的定期监督获得保持。



主任:

李怀林

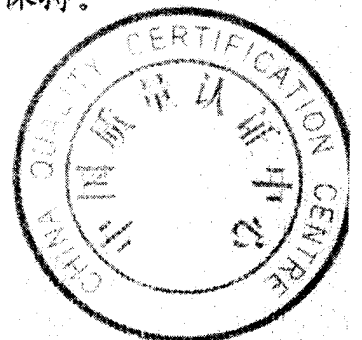

## X-ON Electronics

Largest Supplier of Electrical and Electronic Components

*Click to view similar products for [DC Power Connectors](#) category:*

*Click to view products by [ROCKTEK](#) manufacturer:*

Other Similar products are found below :

[1600206-1](#) [163-0301-EX](#) [163-0302](#) [163-0308-EX](#) [163-0310-EX](#) [163-1061-EX](#) [163-1100-EX](#) [163-4024](#) [163-4117-EX](#) [163-4118-EX](#) [163-5005-E](#) [163-7421](#) [163-MJ22-EX](#) [171-0721-EX](#) [171-0725-EX](#) [171-3118-EX](#) [171-3210-E](#) [171-3221-EX](#) [171-3222-EX](#) [171-A1326-EX](#) [173-23507-ST-EX](#) [173-5521TIP-EX](#) [173-6330TIP-EX](#) [KLDVX-SMT-02-ATR](#) [KLDX-0201-AHT-1](#) [KLDX-0202-AHT](#) [KLDX-SMT-0202-BP](#) [KLDX-SMT-0202-BPTR](#) [163-0179-EX](#) [163-0307-E](#) [163-0309-EX](#) [163-4007-EX](#) [163-4015-EX](#) [163-4025](#) [163-4119-E](#) [163-4303-E](#) [16PJ101-EX](#) [171-0702-EX](#) [171-0722-E](#) [171-0726-EX](#) [171-2122-EX](#) [171-3216-EX](#) [171-3218-EX](#) [171-3219-EX](#) [171-3220-EX](#) [171-7391](#) [173-3413-ST-EX](#) [173-4017-ST-EX](#) [RAPCBRK](#) [K596](#)