

## STANDARD TYPE DIP SWITCHES

### SPECIFICATIONS

Slide, Right Angle, Piano types are available.

Electrical Life: 2,000 operations min.

Contact Resistance: 50mΩ max.

Insulation Resistance: 100MΩ min

Operation Temp:-20°C ~ 70°C

Operation Force: ≤9.8N max.

Stroke: 2.0 mm

Contact Rating: 25mA@24VDC (switching);

100mA@50VDC (non-switching)

### HOW TO ORDER

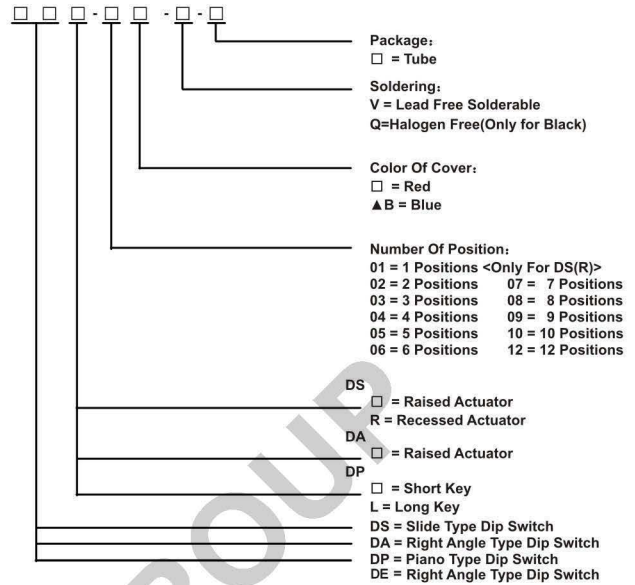

### DA SERIES SLIDE TYPE

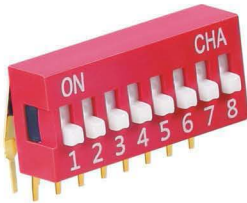

### DIMENSIONS

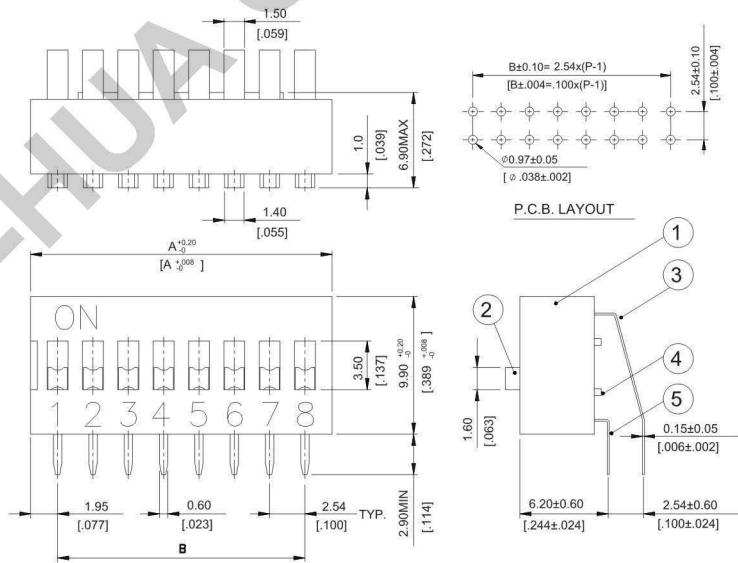

### CONTACT SYSTEM

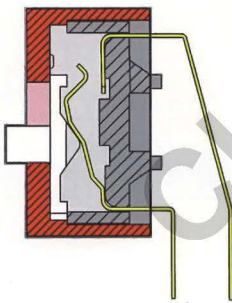

### DE

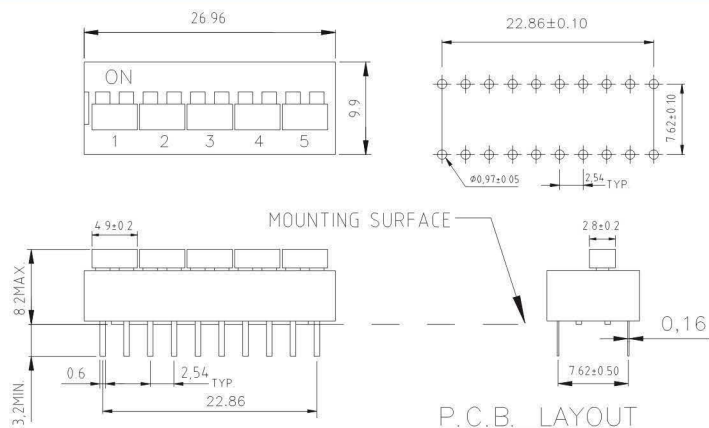
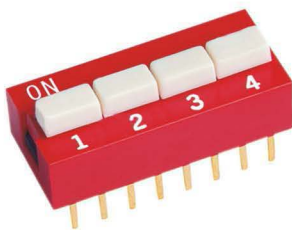

## DS SERIES SLIDE TYPE

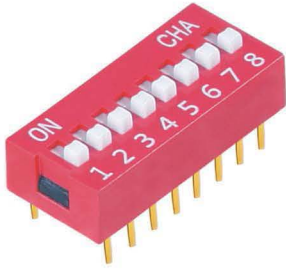

### DIMENSIONS

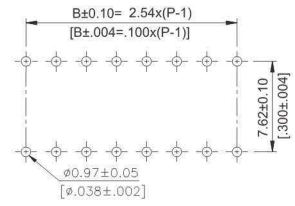
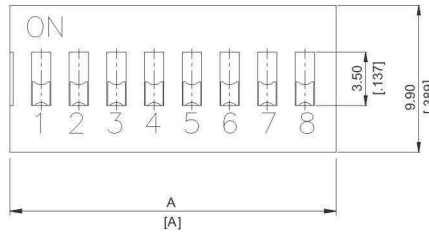

P.C.B. LAYOUT

## CONTACT SYSTEM

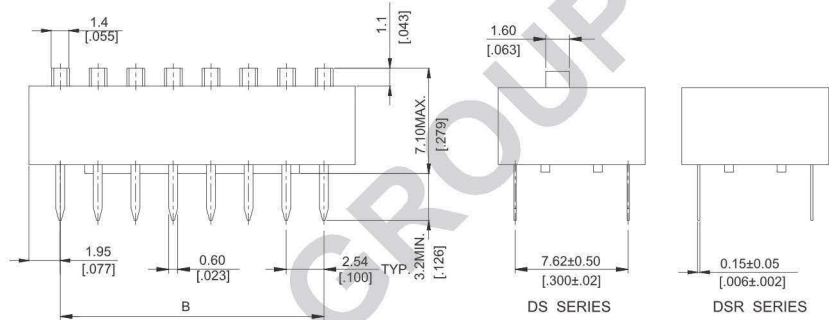
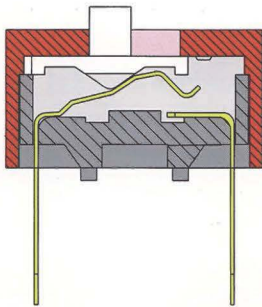

DS SERIES

DSR SERIES

## DP(L) SERIES SLIDE TYPE

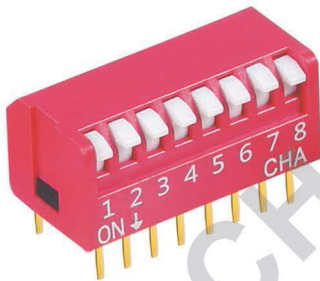

### DIMENSIONS

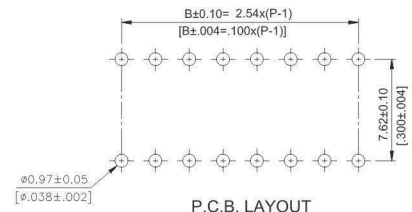
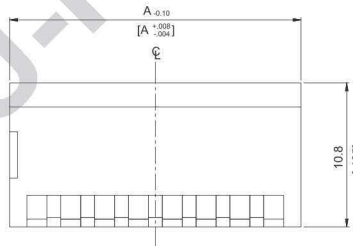

P.C.B. LAYOUT

## CONTACT SYSTEM

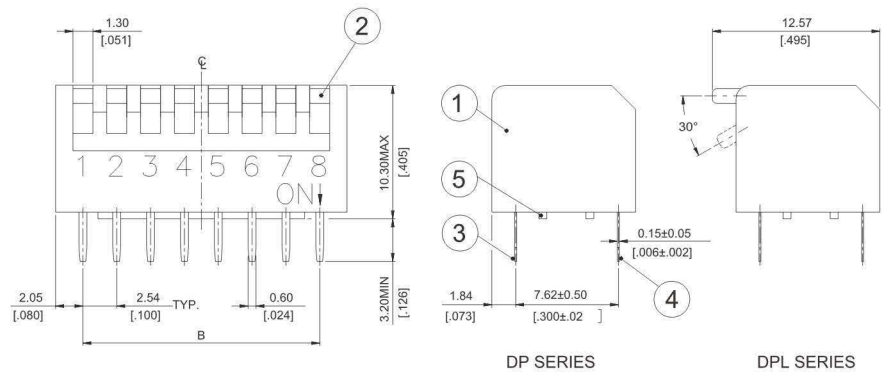
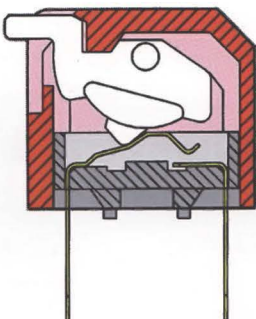

DP SERIES

DPL SERIES

## X-ON Electronics

Largest Supplier of Electrical and Electronic Components

*Click to view similar products for [DIP Switches/SIP Switches](#) category:*

*Click to view products by [Challenge manufacturer](#):*

Other Similar products are found below :

[78M03S](#) [79B10T](#) [8136-475G4T](#) [G7G-1A2-CB-DC12](#) [A7SS-M](#) [DBP 2110](#) [DBP 2112](#) [DBS1008](#) [DHN02FTVTR](#) [DHN10T](#) [DHS108](#)  
[DPL08TN](#) [DRD16CSE04](#) [DRR4010](#) [DRR60016](#) [DRS4016](#) [BD06E](#) [1825008-1](#) [1825444-1](#) [25.350.0653.0](#) [LA2-DC12](#) [SBS 5004 TG](#)  
[SDA10H1BDA](#) [97R06ST](#) [A2C-2A5](#) [1825444-7](#) [ADE08SA04](#) [ADE12S04](#) [2161391-1](#) [2-1825058-8](#) [CCVA 2.5/ 4-G-5.08](#) [P26THRR32](#)  
[25.330.0653.1](#) [25.352.0353.0](#) [MDG305ST](#) [IKN0600000](#) [IKN0800000](#) [LA2-002-DC24](#) [DBP2008](#) [DBS1003](#) [DBS2008](#) [438872000](#)  
[DRD10CRAE04](#) [DRS1604](#) [DSR02T](#) [DSS 208 N](#) [5-1825033-1](#) [106-SDN06-EV](#) [1-1437507-6](#) [E2FMX2D1M1TGJ03M](#)  
[E3ZMCT81M1TJ03M](#)