

Features

- Smallest footprint in chip-scale (CSP): 1.5 x 0.8 mm
- Fixed 32.768 kHz
- <10 ppm frequency tolerance
- Ultra-low power: <1 μ A
- Directly interfaces to XTAL inputs
- Supports coin-cell or super-cap battery backup voltages
- Vdd supply range: 1.5V to 3.63V over -40°C to +85°C
- Oscillator output eliminates external load caps
- Internal filtering eliminates external Vdd bypass cap
- NanoDrive™ programmable output swing for lowest power
- Pb-free, RoHS and REACH compliant

Applications

- Mobile Phones
- Tablets
- Health and Wellness Monitors
- Fitness Watches
- Sport Video Cams
- Wireless Keypads
- Ultra-Small Notebook PC
- Pulse-per-Second (pps) Timekeeping
- RTC Reference Clock
- Battery Management Timekeeping



Electrical Specifications

Table 1. Electrical Characteristics

Parameter	Symbol	Min.	Typ.	Max.	Unit	Condition
Frequency and Stability						
Fixed Output Frequency	F _{out}	32.768			kHz	
Frequency Stability						
Frequency Tolerance ^[1]	F _{tol}			10	ppm	T _A = 25°C, post reflow, V _{dd} : 1.5V – 3.63V.
				20	ppm	T _A = 25°C, post reflow with board-level underfill, V _{dd} : 1.5V – 3.63V.
Frequency Stability ^[2]	F _{stab}			75	ppm	T _A = -10°C to +70°C, V _{dd} : 1.5V – 3.63V.
				100		T _A = -40°C to +85°C, V _{dd} : 1.5V – 3.63V.
				250		T _A = -10°C to +70°C, V _{dd} : 1.2V – 1.5V.
25°C Aging		-1		1	ppm	1st Year
Supply Voltage and Current Consumption						
Operating Supply Voltage	V _{dd}	1.2		3.63	V	T _A = -10°C to +70°C
		1.5		3.63	V	T _A = -40°C to +85°C
Core Operating Current ^[3]	I _{dd}		0.90		μ A	T _A = 25°C, V _{dd} : 1.8V. No load
				1.3		T _A = -10°C to +70°C, V _{dd} max: 3.63V. No load
				1.4		T _A = -40°C to +85°C, V _{dd} max: 3.63V. No load
Output Stage Operating Current ^[3]	I _{dd_out}		0.065	0.125	μ A/Vpp	T _A = -40°C to +85°C, V _{dd} : 1.5V – 3.63V. No load
Power-Supply Ramp	t _{Vdd Ramp}			100	ms	V _{dd} Ramp-up from 0 to 90%, T _A = -40°C to +85°C
Start-up Time at Power-up ^[4]	t _{start}		180	300	ms	T _A = -40°C \leq T _A \leq +50°C, valid output
				450		T _A = +50°C < T _A \leq +85°C, valid output
Operating Temperature Range						
Commercial Temperature	T _{use}	-10		70	$^{\circ}$ C	
Industrial Temperature		-40		85	$^{\circ}$ C	

Notes:

1. Measured peak-to-peak. Tested with Agilent 53132A frequency counter. Due to the low operating frequency, the gate time must be \geq 100 ms to ensure an accurate frequency measurement.
2. Measured peak-to-peak. Inclusive of Initial Tolerance at 25°C, and variations over operating temperature, rated power supply voltage and load. Stability is specified for two operating voltage ranges. Stability progressively degrades with supply voltage below 1.5V.
3. Core operating current does not include output driver operating current or load current. To derive total operating current (no load), add core operating current + (0.065 μ A/V) * (output voltage swing).
4. Measured from the time V_{dd} reaches 1.5V.

Table 1. Electrical Characteristics (continued)

Parameter	Symbol	Min.	Typ.	Max.	Unit	Condition
LVC MOS Output Option, T_A = -40°C to +85°C, typical values are at T_A = 25°C						
Output Rise/Fall Time	tr, tf		100	200	ns	10-90% (V _{dd}), 15 pF load, V _{dd} = 1.5V to 3.63V
				50		10-90% (V _{dd}), 5 pF load, V _{dd} ≥ 1.62V
Output Clock Duty Cycle	DC	48		52	%	
Output Voltage High	VOH	90%			V	V _{dd} : 1.5V – 3.63V. I _{OH} = -10 μA, 15 pF
Output Voltage Low	VOL			10%	V	V _{dd} : 1.5V – 3.63V. I _{OL} = 10 μA, 15 pF
NanoDrive™ Programmable, Reduced Swing Output						
Output Rise/Fall Time	tf, tf			200	ns	30-70% (V _{OL} /V _{OH}), 10 pF Load
Output Clock Duty Cycle	DC	48		52	%	
AC-coupled Programmable Output Swing	V _{sw}		0.20 to 0.80		V	SiT1532 does not internally AC-couple. This output description is intended for a receiver that is AC-coupled. See Table 5 for acceptable NanoDrive swing options. V _{dd} : 1.5V – 3.63V, 10 pF Load, I _{OH} / I _{OL} = ±0.2 μA.
DC-Biased Programmable Output Voltage High Range	VOH		0.60 to 1.225		V	V _{dd} : 1.5V – 3.63V. I _{OH} = -0.2 μA, 10 pF Load. See Table 4 for acceptable V _{OH} /V _{OL} setting levels.
DC-Biased Programmable Output Voltage Low Range	VOL		0.35 to 0.80		V	V _{dd} : 1.5V – 3.63V. I _{OL} = 0.2 μA, 10 pF Load. See Table 4 for acceptable V _{OH} /V _{OL} setting levels.
Programmable Output Voltage Swing Tolerance		-0.055		0.055	V	T _A = -40°C to +85°C, V _{dd} = 1.5V to 3.63V.
Jitter						
Period Jitter	T _{jitt}		35		nsRMS	Cycles = 10,000, T _A = 25°C, V _{dd} = 1.5V – 3.63V

Table 2. Pin Configuration

Pin	Symbol	I/O	Functionality
1, 4	GND	Power Supply Ground	Connect to ground. Acceptable to connect pin 1 and 4 together. Both pins must be connected to GND.
2	CLK Out	OUT	Oscillator clock output. The CLK can drive into a Ref CLK input or into an ASIC or chip-set's 32kHz XTAL input. When driving into an ASIC or chip-set oscillator input (X IN and X Out), the CLK Out is typically connected directly to the XTAL IN pin. No need for load capacitors. The output driver is intended to be insensitive to capacitive loading.
3	V _{dd}	Power Supply	Connect to power supply 1.2V ≤ V _{dd} ≤ 3.63V. Under normal operating conditions, V _{dd} does not require external bypass/decoupling capacitor(s). For more information about the internal power-supply filtering, see the Power Supply Noise Immunity section in the detailed description. Contact factory for applications that require a wider operating supply voltage range.

CSP Package (Top View)

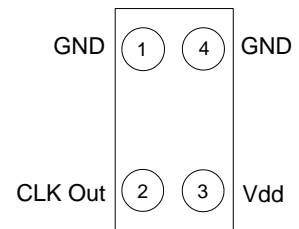

Figure 1. Pin Assignments

System Block Diagram

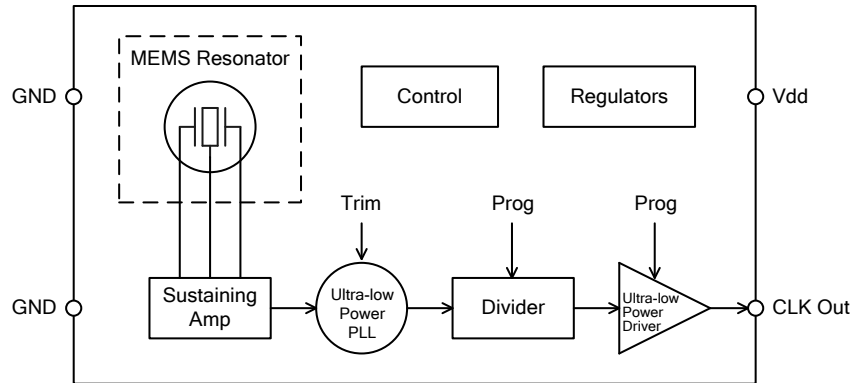

Figure 2. SiT1532 Block Diagram

Table 3. Absolute Maximum Limits

Attempted operation outside the absolute maximum ratings may cause permanent damage to the part. Actual performance of the IC is only guaranteed within the operational specifications, not at absolute maximum ratings.

Parameter	Test Condition	Value	Unit
Continuous Power Supply Voltage Range (Vdd)		-0.5 to 3.63	V
Short Duration Maximum Power Supply Voltage (Vdd)	<30 minutes	4.0	V
Continuous Maximum Operating Temperature Range	Vdd = 1.5V - 3.63V	105	°C
Short Duration Maximum Operating Temperature Range	Vdd = 1.5V - 3.63V, ≤30 mins	125	°C
Human Body Model ESD Protection	JESD22-A114	3000	V
Charge-Device Model (CDM) ESD Protection	JESD22-C101	750	V
Machine Model (MM) ESD Protection	JESD22-A115	300	V
Latch-up Tolerance	JESD78 Compliant		
Mechanical Shock Resistance	Mil 883, Method 2002	10,000	g
Mechanical Vibration Resistance	Mil 883, Method 2007	70	g
1508 CSP Junction Temperature		150	°C

Description

The SiT1532 is the world's smallest, lowest power 32 kHz oscillator optimized for mobile and other battery-powered applications. SiTime's silicon MEMS technology enables the smallest footprint and chip-scale packaging. This device reduces the 32 kHz footprint by as much as 85% compared to existing 2.0 x 1.2 mm SMD XTAL packages. Unlike XTALs, the SiT1532 oscillator output enables greater component placement flexibility and eliminates external load capacitors, thus saving additional component count and board space. And unlike standard oscillators, the SiT1532 features NanoDrive™, a factory programmable output that reduces the voltage swing to minimize power.

The 1.2V to 3.63V operating supply voltage range makes it an ideal solution for mobile applications that incorporate a low-voltage, battery-back-up source such as a coin-cell or super-cap.

SiTime's MEMS oscillators consist of MEMS resonators and a programmable analog circuit. Our MEMS resonators are built with SiTime's unique MEMS First™ process. A key manufacturing step is EpiSeal™ during which the MEMS resonator is annealed with temperatures over 1000°C. EpiSeal creates an extremely strong, clean, vacuum chamber that encapsulates the MEMS resonator and ensures the best performance and reliability. During EpiSeal, a poly silicon cap is grown on top of the resonator cavity, which eliminates the need for additional cap wafers or other exotic packaging. As a result, SiTime's MEMS resonator die can be used like any other semiconductor die. One unique result of SiTime's MEMS First and EpiSeal manufacturing processes is the capability to integrate SiTime's MEMS die with a SOC, ASIC, microprocessor or analog die within a package to eliminate external timing components and provide a highly integrated, smaller, cheaper solution to the customer.

Frequency Stability

The SiT1532 is factory calibrated (trimmed) to guarantee frequency stability to be less than 10 ppm at room temperature and less than 100 ppm over the full -40°C to +85°C temperature range. Unlike quartz crystals that have a classic tuning fork parabola temperature curve with a 25°C turnover point, the SiT1532 temperature coefficient is extremely flat across temperature. The device maintains less than 100 ppm frequency stability over the full operating temperature range when the operating voltage is between 1.5 and 3.63V as shown in Figure 3.

Functionality is guaranteed over the 1.2V – 3.63V operating supply voltage range. However, frequency stability degrades below 1.5V and steadily degrades as it approaches the 1.2V minimum supply due to the internal regulator limitations. Between 1.2V and 1.5V, the frequency stability is 250 ppm max over temperature.

When measuring the SiT1532 output frequency with a frequency counter, it is important to make sure the counter's gate time is ≥ 100 ms. The slow frequency of a 32kHz clock will give false readings with faster gate times.

Contact [SiTime](#) for applications that require a wider supply voltage range >3.63V or lower frequency options as low as 1Hz.

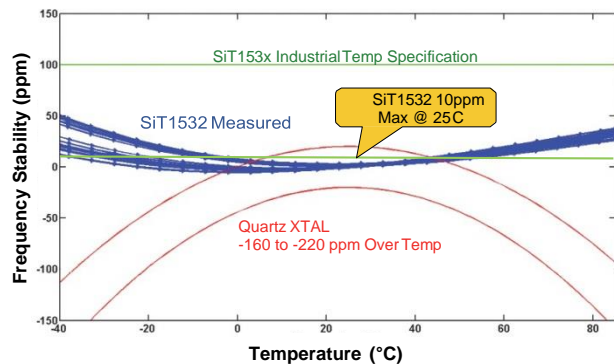

Figure 3. SiTime vs. Quartz

Power Supply Noise Immunity

In addition to eliminating external output load capacitors common with standard XTALs, The SiT1532 includes special internal power supply filtering and thus, eliminates the need for an external Vdd bypass-decoupling capacitor. This feature further simplifies the design and keeps the footprint as small as possible. Internal power supply filtering is designed to reject greater than ± 150 mVpp magnitude and frequency components through 10 MHz.

Output Voltage

The SiT1532 has two output voltage options. One option is a standard LVCMOS output swing. The second option is the NanoDrive reduced swing output. Output swing is customer specific and programmed between 200 mV and 800 mV. For DC-coupled applications, output V_{OH} and V_{OL} are individually factory programmed to the customers' requirement. V_{OH} programming range is between 600 mV and 1.225V in 100 mV increments. Similarly, V_{OL} programming range is between 350 mV and 800 mV. For example; a PMIC or MCU is internally 1.8V logic compatible, and requires a 1.2V V_{IH} and a 0.6V V_{IL} . Simply select SiT1532 NanoDrive factory programming code to be "D14" and the correct output thresholds will match the downstream PMIC or MCU input requirements. Interface logic will vary by manufacturer and we recommend that you review the input voltage requirements for the input interface.

For DC-biased NanoDrive output configuration, the minimum V_{OL} is limited to 350mV and the maximum allowable swing ($V_{OH} - V_{OL}$) is 750 mV. For example, 1.1V V_{OH} and 400 mV V_{OL} is acceptable, but 1.2V V_{OH} and 400 mV V_{OL} is not acceptable.

When the output is interfacing to an XTAL input that is internally AC-coupled, the SiT1532 output can be factory programmed to match the input swing requirements. For example, if a PMIC or MCU input is internally AC-coupled and requires an 800 mV swing, then simply choose the SiT1532 NanoDrive programming code "AA8" in the part number. It is important to note that the SiT1532 does not include internal AC-coupling capacitors. Please see the [Part Number Ordering](#) section at the end of the datasheet for more information about the part number ordering scheme.

Power-up

The SiT1532 starts-up to a valid output frequency within 300 ms (180 ms typ). To ensure the device starts-up within the specified limit, make sure the power-supply ramps-up in approximately 10 – 20 ms (to within 90% of Vdd). Start-up time is measured from the time Vdd reaches 1.5V. For applications that operate between 1.2V and 1.5V, the start-up time will be typically 50 ms longer over temperature.

SiT1532 NanoDrive™

Figure 4 shows a typical output waveform of the SiT1532 (into a 10 pF load) when factory programmed for a 0.70V swing and DC bias (V_{OH}/V_{OL}) for 1.8V logic:

Example:

- NanoDrive™ part number coding: D14.
Example part number: SiT1532AI-J4-D14-32.768
- V_{OH} = 1.1V, V_{OL} = 0.4V (V_{sw} = 0.70V)

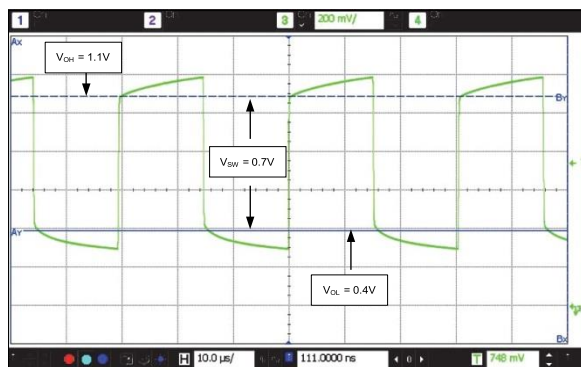

Figure 4. SiT1532AI-J4-D14-32.768 Output Waveform (10 pF load)

Table 4 shows the supported NanoDrive™ V_{OH}, V_{OL} factory programming options.

Table 4. Acceptable V_{OH}/V_{OL} NanoDrive™ Levels

NanoDrive	V _{OH} (V)	V _{OL} (V)	Swing (mV)	Comments
D26	1.2	0.6	600 ±55	1.8V logic compatible
D14	1.1	0.4	700 ±55	1.8V logic compatible
D74	0.7	0.4	300 ±55	XTAL compatible
AA3	n/a	n/a	300 ±55	XTAL compatible

The values listed in Table 4 are nominal values at 25°C and will exhibit a tolerance of ±55 mV across Vdd and -40°C to 85°C operating temperature range.

SiT1532 Full Swing LVCMOS Output

The SiT1532 can be factory programmed to generate full-swing LVCMOS levels. Figure 5 shows the typical waveform (Vdd = 1.8V) at room temperature into a 15 pF load.

Example:

- LVCMOS output part number coding is always **DCC**
- Example part number: SiT1532AI-J4-DCC-32.768

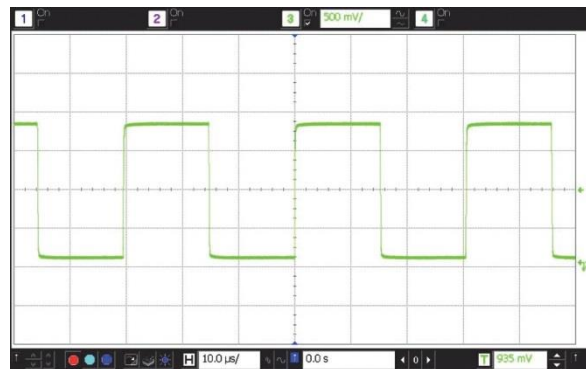

Figure 5. LVCMOS Waveform (Vdd = 1.8V) into 15 pF Load

Calculating Load Current

No Load Supply Current

When calculating no-load power for the SiT1532, the core and output driver components need to be added. Since the output voltage swing can be programmed for reduced swing between 250 mV and 800 mV for ultra-low power applications, the output driver current is variable. Therefore, no-load operating supply current is broken into two sections; core and output driver. The equation is as follows:

$$\text{Total Supply Current (no load)} = I_{dd} \text{ Core} + (65\text{nA/V})(V_{out_{pp}})$$

Example 1: Full-swing LVCMOS

- Vdd = 1.8V
- Idd Core = 900nA (typ)
- Vout_{pp} = 1.8V

$$\text{Supply Current} = 900\text{nA} + (65\text{nA/V})(1.8\text{V}) = 1017\text{nA}$$

Example 2: NanoDrive™ Reduced Swing

- Vdd = 1.8V
- Idd Core = 900nA (typ)
- Vout_{pp} (D14) = V_{OH} - V_{OL} = 1.1V - 0.4V = 700mV

$$\text{Supply Current} = 900\text{nA} + (65\text{nA/V})(0.7\text{V}) = 946\text{nA}$$

Total Supply Current with Load

To calculate the total supply current, including the load, follow the equation listed below. Note the 30% reduction in power with NanoDrive™.

$$\text{Total Current} = I_{dd} \text{ Core} + I_{dd} \text{ Output Driver} (65\text{nA/V} \cdot V_{out_{pp}}) + \text{Load Current} (C \cdot V \cdot F)$$

Example 1: Full-swing LVCMOS

- Vdd = 1.8V
- Idd Core = 900nA
- Load Capacitance = 10pF
- Idd Output Driver: (65nA/V)(1.8V) = 117nA
- Load Current: (10pF)(1.8V)(32.768kHz) = 590nA
- Total Current = 900nA + 117nA + 590nA = 1.6μA

Example 2: NanoDrive™ Reduced Swing

- Vdd = 1.8V
- Idd Core = 900nA
- Load Capacitance = 10pF
- Vout_{pp} (D14): V_{OH} - V_{OL} = 1.1V - 0.4V = 700mV
- Idd Output Driver: (65nA/V)(0.7V) = 46nA
- Load Current: (10pF)(0.7V)(32.768kHz) = 229nA
- Total Current = 900nA + 46nA + 229nA = 1.175μA

Typical Operating Curves

(T_A = 25°C, V_{dd} = 1.8V, unless otherwise stated)

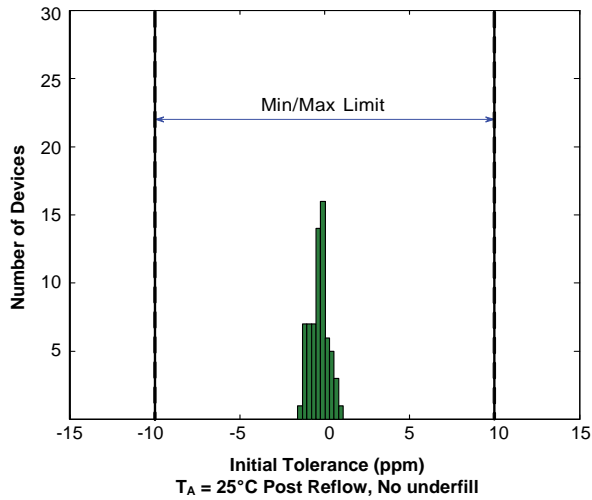

Figure 6. Initial Tolerance Histogram

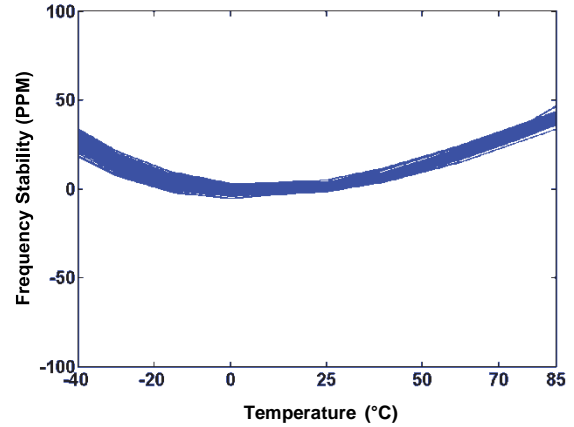

Figure 7. Frequency Stability Over Temperature

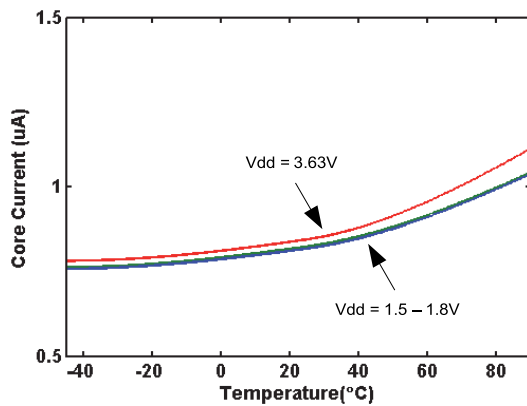

Figure 8. Core Current Over Temperature

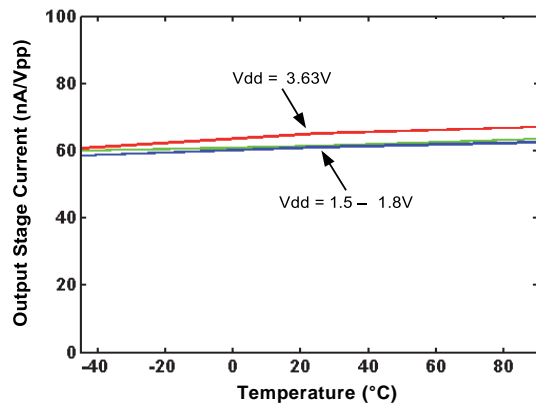

Figure 9. Output Stage Current Over Temperature

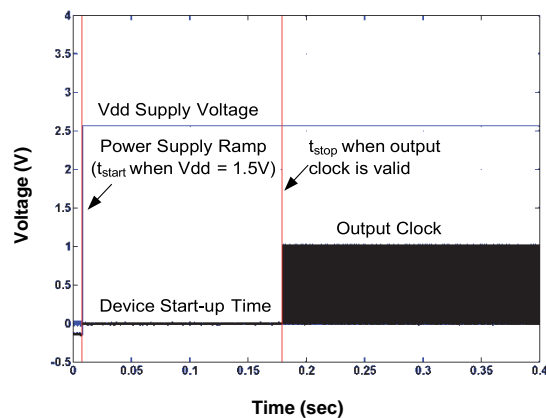

Figure 10. Start-up Time

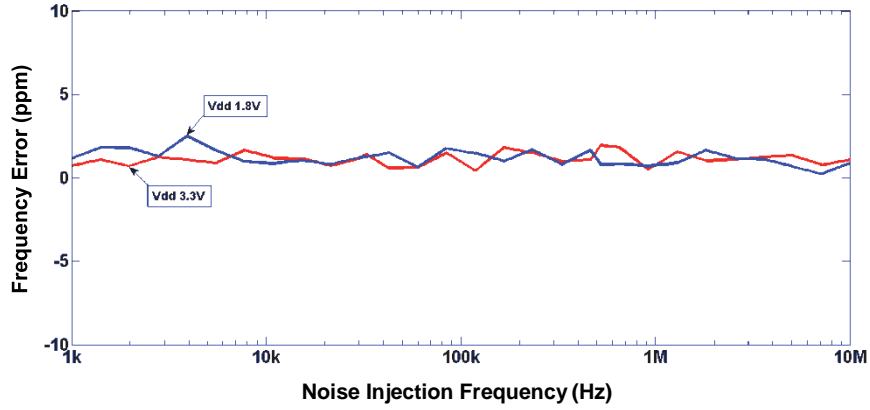

Figure 11. Power Supply Noise Rejection
(±150mV Noise)

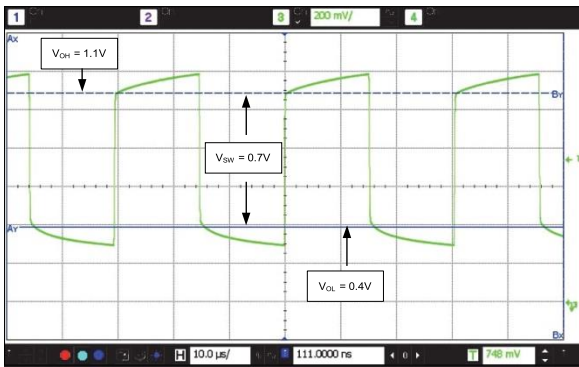

Figure 12. NanoDrive™ Output Waveform
($V_{OH} = 1.1V$, $V_{OL} = 0.4V$; SiT1532AI-J4-D14-32.768)

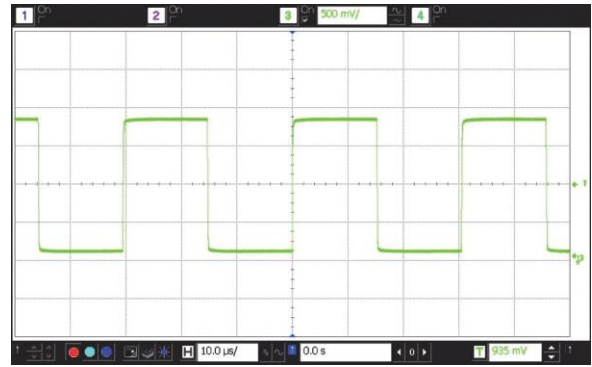

Figure 13. LVCMOS Output Waveform
($V_{swing} = 1.8V$, SiT1532AI-J4-DCC-32.768)

Dimensions and Patterns

Package Size – Dimensions (Unit: mm)	Recommended Land Pattern (Unit: mm)
<p>1.55 x 0.85 mm CSP</p>	<p> $\phi 0.25$ (4x) NSMD pads $\phi 0.35$ (4x) Soldermask openings (soldermask openings shown with dashed line around NSMD pad) </p> <p>Recommend 4-mil (0.1mm) stencil thickness</p>

Manufacturing Guidelines

- 1) No Ultrasonic Cleaning: Do not subject the SiT1532 to an ultrasonic cleaning environment. Permanent damage or long term reliability issues to the MEMS structure may occur.
- 2) Applying board-level underfill (BLUF) to the device is acceptable, but will cause a shift in the frequency tolerance, as specified in the datasheet electrical table. Tested with UF3810, UF3808, and FP4530 underfill.
- 3) Reflow profile, per JESD22-A113D.
- 4) For additional manufacturing guidelines and marking/tape-reel instructions, refer to [SiTime Manufacturing Notes](#).

Ordering Information

Part number characters in blue represent the customer specific options. The other characters in the part number are fixed.

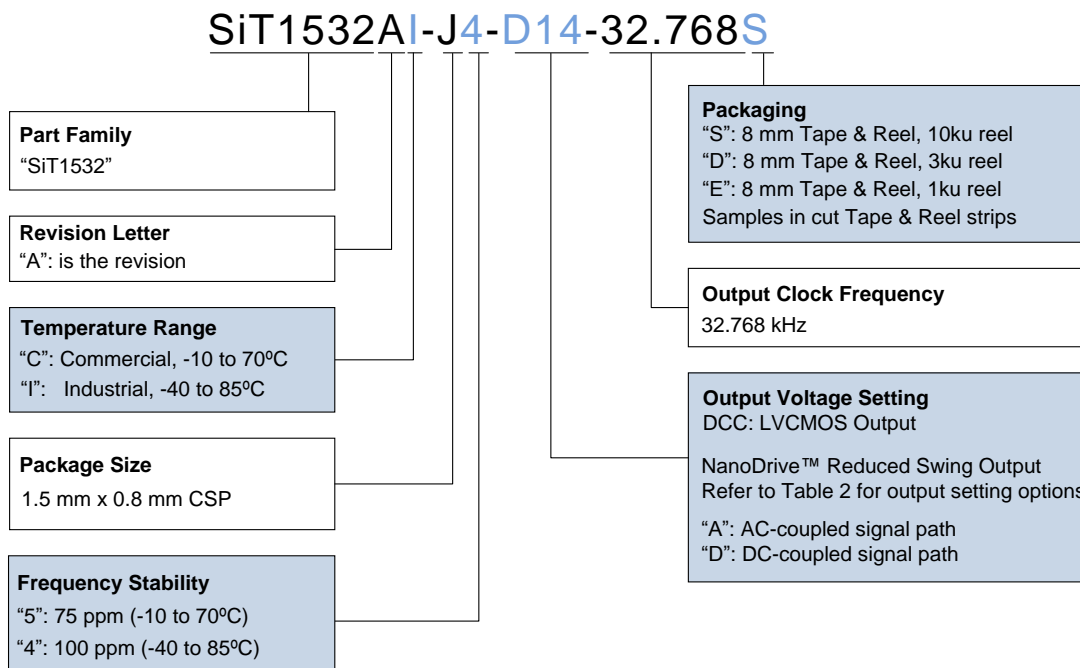

The following examples illustrate how to select the appropriate temp range and output voltage requirements:

Example 1: SiT1532AI-J4-D14-32.768

- 1) Industrial temp & corresponding 100 ppm frequency stability. Note, 100 ppm is only available for the industrial temp range, and 75 ppm is only available for the commercial temp range.
- 2) Output swing requirements:
 - a) "D" = DC-coupled receiver
 - b) "1" = $V_{OH} = 1.1V$
 - c) "4" = $V_{OL} = 400mV$

Example 2: SiT1532AC-J5-AA3-32.768

- 1) Commercial temp & corresponding 75 ppm frequency stability. Note, 100 ppm is only available for the industrial temp range, and 75 ppm is only available for the commercial temp range.
- 2) Output swing requirements:
 - a) "A" = AC-coupled receiver
 - b) "A" = AC-coupled receiver
 - c) "3" = 300mV swing

Table 5. Acceptable V_{OH}/V_{OL} NanoDrive™ Levels^[5]

NanoDrive	V_{OH} (V)	V_{OL} (V)	Swing (mV)	Comments
D26	1.2	0.6	600 ±55	1.8V logic compatible
D14	1.1	0.4	700 ±55	1.8V logic compatible
D74	0.7	0.4	300 ±55	XTAL compatible
AA3	n/a	n/a	300 ±55	XTAL compatible

Note:

5. If these available options do not accommodate your application, contact Factory for other NanoDrive options.

Table 6. Revision History

Version	Release Date	Change Summary
1.0	09/02/2014	Rev 0.9 Preliminary to Rev 1.0 Production Release Updated start-up timespecification Added typical operating plots Separated initial tolerance spec for condition with and without underfill Added Manufacturing Guidelines section
1.1	10/14/2014	Improved Start-up Time at Power-up spec Added 5pF LVCMOS rise/fall time spec
1.2	11/07/2014	Updated 5pF LVCMOS rise/fall time spec
1.25	06/03/2016	Updated NanoDrive section Updated test conditions in the absolute maximum table
1.26	01/16/2018	Updated SPL, page layout changes

SiTime Corporation, 5451 Patrick Henry Drive, Santa Clara, CA 95054, USA | Phone: +1-408-328-4400 | Fax: +1-408-328-4439

© SiTime Corporation 2014-2018. The information contained herein is subject to change at any time without notice. SiTime assumes no responsibility or liability for any loss, damage or defect of a Product which is caused in whole or in part by (i) use of any circuitry other than circuitry embodied in a SiTime product, (ii) misuse or abuse including static discharge, neglect or accident, (iii) unauthorized modification or repairs which have been soldered or altered during assembly and are not capable of being tested by SiTime under its normal test conditions, or (iv) improper installation, storage, handling, warehousing or transportation, or (v) being subjected to unusual physical, thermal, or electrical stress.

Disclaimer: SiTime makes no warranty of any kind, express or implied, with regard to this material, and specifically disclaims any and all express or implied warranties, either in fact or by operation of law, statutory or otherwise, including the implied warranties of merchantability and fitness for use or a particular purpose, and any implied warranty arising from course of dealing or usage of trade, as well as any common-law duties relating to accuracy or lack of negligence, with respect to this material, any SiTime product and any product documentation. Products sold by SiTime are not suitable or intended to be used in a life support application or component, to operate nuclear facilities, or in other mission critical applications where human life may be involved or at stake. All sales are made conditioned upon compliance with the critical uses policy set forth below.

CRITICAL USE EXCLUSION POLICY

BUYER AGREES NOT TO USE SITIME'S PRODUCTS FOR ANY APPLICATION OR IN ANY COMPONENTS USED IN LIFE SUPPORT DEVICES OR TO OPERATE NUCLEAR FACILITIES OR FOR USE IN OTHER MISSION-CRITICAL APPLICATIONS OR COMPONENTS WHERE HUMAN LIFE OR PROPERTY MAY BE AT STAKE.

SiTime owns all rights, title and interest to the intellectual property related to SiTime's products, including any software, firmware, copyright, patent, or trademark. The sale of SiTime products does not convey or imply any license under patent or other rights. SiTime retains the copyright and trademark rights in all documents, catalogs and plans supplied pursuant to or ancillary to the sale of products or services by SiTime. Unless otherwise agreed to in writing by SiTime, any reproduction, modification, translation, compilation, or representation of this material shall be strictly prohibited.

X-ON Electronics

Largest Supplier of Electrical and Electronic Components

Click to view similar products for [Standard Clock Oscillators](#) category:

Click to view products by [SiTime](#) manufacturer:

Other Similar products are found below :

[EP1400SJTSC-125.000M](#) [601137](#) [601252](#) [CSX750FBC-24.000M-UT](#) [CSX750FBC-33.333M-UT](#) [CSX750FCC-3.6864M-UT](#) [F335-12](#) [F335-25](#) [DSC506-03FM2](#) [ASA-20.000MHZ-L-T](#) [ASA-25.000MHZ-L-T](#) [ASA-27.000MHZ-L-T](#) [ASV-20.000MHZ-LR-T](#) [ECS-2018-160-BN-TR](#) [EL13C7-H2F-125.00M](#) [MXO45HS-2C-66.6666MHZ](#) [SiT1602BI-22-33E-50.000000E](#) [SIT8003AC-11-33S-2.04800X](#) [SiT8256AC-23-33E-156.250000X](#) [SIT8918AA-11-33S-50.000000G](#) [SM4420TEV-40.0M-T1K](#) [F335-24](#) [F335-40](#) [F335-50](#) [F535L-10](#) [F535L-12](#) [F535L-16](#) [F535L-27](#) [F535L-48](#) [PE7744DW-100.0M](#) [CSX750FBC-20.000M-UT](#) [CSX-750FBC33333000T](#) [CSX750FBC-4.000M-UT](#) [CSX750FBC-7.3728M-UT](#) [CSX750FBC-8.000M-UT](#) [CSX-750FCC14745600T](#) [CSX750FCC-16.000M-UT](#) [CSX-750FCC40000000T](#) [CSX750FCC-4.000M-UT](#) [ASA-22.000MHZ-L-T](#) [ASA2-26.000MHZ-L-T](#) [ASA-40.000MHZ-L-T](#) [ASA-48.000MHZ-L-T](#) [ASA-60.000MHZ-L-T](#) [ASF1-3.686MHZ-N-K-S](#) [XO37CTECNA10M](#) [XO57CRECNA16M](#) [XO57CTECNA3M6864](#) [XO57CTECNA4M9152](#) [DSC400-0333Q0032KE1-EVB](#)