

Specification for Approval

Date: 2014/06/25

Customer : 東莞台慶

TAI-TECH P/N: HPC4018B-4R7M

CUSTOMER P/N: _____

DESCRIPTION: _____

QUANTITY: _____ pcs

REMARK:		
Customer Approval Feedback		

西北臺慶科技股份有限公司
TAI-TECH Advanced Electronics Co., Ltd

西北臺慶科技股份有限公司
 TAI-TECH Advanced Electronics Co., Ltd
Headquarter:
 NO.1 YOU 4TH ROAD, YOUTH INDUSTRIAL DISTRICT, YANG-MEI,
 TAO-YUAN HSIEN, TAIWAN, R.O.C.
 TEL: +886-3-4641148 FAX: +886-3-4643565
 http://www.tai-tech.com.tw
 E-mail: sales@tai-tech.com.tw

東莞臺慶精密電子有限公司
 DONGGUAN TAI-TECH ADVANCED ELECTRONICS CO., LTD
 JITIGANG MANAGEMENT DISTRICT, HUANGJIANG, DONGGUAN,
 GUANGDONG, CHINA
 TEL: +86-769-3365488 FAX: +86-769-3366896
 E-mail: sales@tai-tech.net

Office:
 金亨國際有限公司
 KAMHENG INTERNATIONAL LIMITED
 TEL: +86-852-25772033 FAX: +86-852-28817778

臺慶精密電子(昆山)有限公司
 TAI-TECH ADVANCED ELECTRONICS(KUNSHAN) CO., LTD
 SHINWHA ROAD, KUNJIA HI-TECH INDUSTRIAL PARK, KUN-SHAN,
 JIANG-SU, CHINA
 TEL: +86-512-57619396 FAX: +86-512-57619688
 E-mail: sales@tai-tech.cn

Office:
 北欣國際有限公司
 NORTH STAR INTERNATIONAL LIMITED
 TEL: +86-512-57619396 FAX: +86-512-57619688

Sales Dep.

APPROVED	CHECKED
林巧盈 Emily Lin	林巧盈 Emily Lin

R&D Center

APPROVED	CHECKED	DRAWN
楊祥忠 Mikey Yang	詹偉特 Jack Chan	徐允珮 Shelly Hsu

Power Inductor

HPC4018B-4R7M

ECN HISTORY LIST

REV	DATE	DESCRIPTION	APPROVED	CHECKED	DRAWN
1.0	14/06/25	新發行	楊祥忠	詹偉特	徐允珮
備註					

Power Inductor

HPC4018B-4R7M

1. Features

1. This specification applies Low Profile Power Inductors.
2. 100% Lead(Pb) & Halogen-Free and RoHS compliant.



2. Dimension

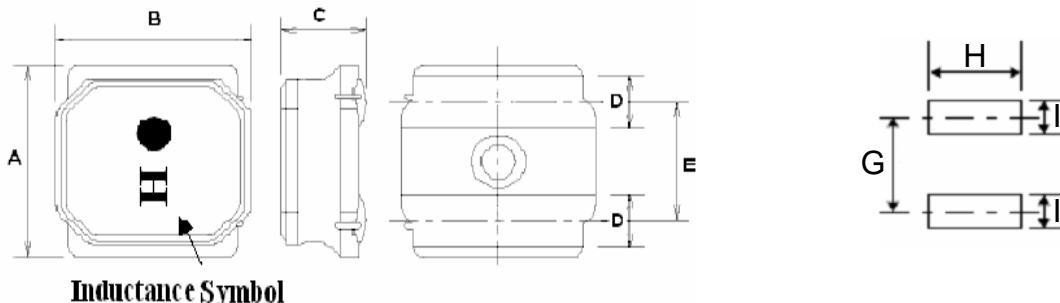

Series	A(mm)	B(mm)	C(mm)	D(mm)	E(mm)	G(mm)	H(mm)	I(mm)
HPC4018B	4.0±0.2	4.0±0.2	1.8 max.	1.1±0.2	2.5±0.2	2.8 ref.	3.7 ref.	1.2 ref.

Units: mm

3. Part Numbering

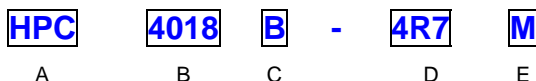

- A: Series
- B: Dimension
- C: Control S/N
- D: Inductance 4R7=4.7 uH
- E: Inductance Tolerance M=±20%

4. Specification

TAI-TECH Part Number	Inductance Symbol	Inductance (uH)	Tolerance (%)	Test Frequency (Hz)	SRF (MHz) min.	DCR (Ω) ±20%	I sat (A)	I rms (A)
HPC4018B-4R7M	H	4.7	±20%	1V100K	35	0.070	2.00	1.70

Note:

Isat : Based on inductance change (ΔL/L0 : ≤-30%) @ ambient temp. 25°C

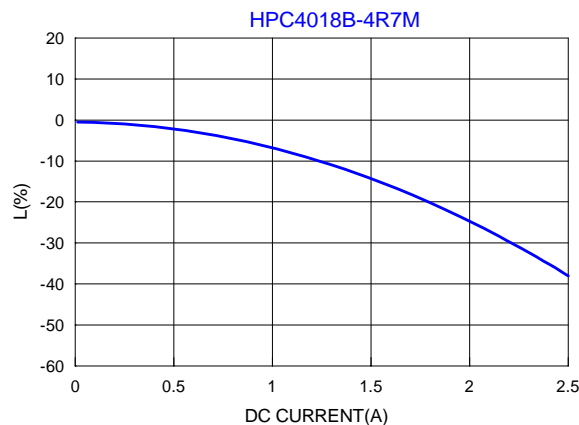
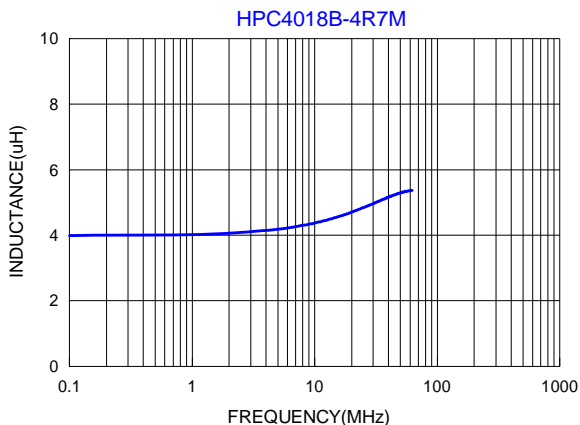

Core chipping

The appearance standard of the chipping size on top side, and bottom side ferrite core is listed below.

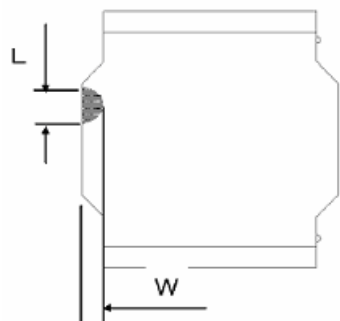

Type	L	W
HPC4018B	1.5mm Max.	1.5mm Max.

Void appearance tolerance Limit

Size of voids occurring to coating resin is specified below.

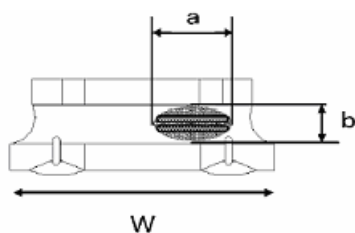

Exposed wire tolerance limit of coating resin part on product side.

Size of exposed wire occurring to coating resin is specified below.



1. Width direction (dimension a) : Acceptable when $a \leq w/2$
Nonconforming when $a > w/2$
2. Length direction (dimension b) : Dimension b is not specified.
3. The total area of exposed wire occurring to each sides is not greater than 50% of coating resin area, and is acceptable.

External appearance criterion for exposed wire

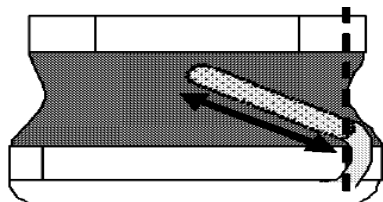
Exposed end of the winding wire at the secondary side should be 2mm and below.

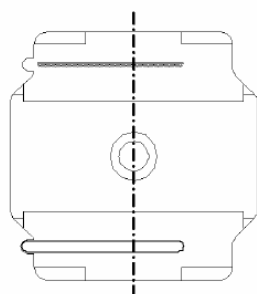

5. Exectrde appearance criterion for exposed wire

Only top side of wire is exposed.
(regardless of whole tope side of wire exposed)

Conforming



Wire is soldered insufficiently and less than half of outer diameter is covered with solder.

Less than 1/2 of joint side length.
(More than 1/2 is selected as defect)

6. Material List

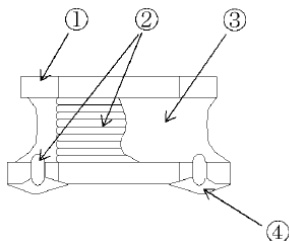

No.	Item	Material
1	Core	Ni-Zn ferrite
2	Wire	Copper Wire
3	Coating	Epoxy with magnetic
4	Solder	Lead free

7. Reliability and Test Condition

Item	Performance	Test Method and Remarks															
Operating Temperature	-40~+85°C	Including self-generated heat															
Storage Temperature	-40~+85°C (on board)																
Rated current	Within the specified tolerance																
Inductance (L)		LCR Meter: HP 4285A or equivalent, 100kHz, 1V															
DC Resistance		DC Ohmmeter: HIOKI3227 or equivalent															
Life Test	Appearance : No damage. Inductance : within±10% of initial value Q : Shall not exceed the specification value. RDC : within ±15% of initial value and shall not exceed the specification value	Preconditioning:Run through IR reflow for 2 times.(IPC/JEDEC J-STD-020DClassification Reflow Profiles) Temperature : 125±2°C (Bead) Temperature : 85±2°C (Inductor) Applied current : rated current Duration : 1000±12hrs Measured at room temperature after placing for 24±2 hrs															
Load Humidity		Preconditioning:Run through IR reflow for 2 times.(IPC/JEDEC J-STD-020DClassification Reflow Profiles) Humidity : 85±2 % R.H. Temperature : 85°C±2°C Duration : 1000hrs Min. with 100% rated current Measured at room temperature after placing for 24±2 hrs															
Thermal shock		Preconditioning:Run through IR reflow for 2 times.(IPC/JEDEC J-STD-020DClassification Reflow Profiles) Condition for 1 cycle Step1 : -40±2°C 30±5min Step2 : 25±2°C ≤0.5min Step3 : 105±2°C 30±5min Number of cycles : 500 Measured at room fempraturc after placing for 24±2 hrs															
Vibration		Oscillation Frequency: 10~2K~10Hz for 20 minutes Equipment : Vibration checker Total Amplitude:1.52mm±10% Testing Time : 12 hours(20 minutes, 12 cycles each of 3 orientations) °															
Shock		<table border="1"> <thead> <tr> <th>Type</th> <th>Peak value (g's)</th> <th>Normal duration (D) (ms)</th> <th>Wave form</th> <th>Velocity change (Vi)ft/sec</th> </tr> </thead> <tbody> <tr> <td>SMD</td> <td>1500</td> <td>0.5</td> <td>Half-sine</td> <td>15.4</td> </tr> <tr> <td>Lead</td> <td>100</td> <td>6</td> <td>Half-sine</td> <td>12.3</td> </tr> </tbody> </table>	Type	Peak value (g's)	Normal duration (D) (ms)	Wave form	Velocity change (Vi)ft/sec	SMD	1500	0.5	Half-sine	15.4	Lead	100	6	Half-sine	12.3
Type		Peak value (g's)	Normal duration (D) (ms)	Wave form	Velocity change (Vi)ft/sec												
SMD		1500	0.5	Half-sine	15.4												
Lead	100	6	Half-sine	12.3													
Bending	Shall be mounted on a FR4 substrate of the following dimensions: >=0805:40x100x1.2mm <0805:40x100x0.8mm Bending depth: >=0805:1.2mm <0805:0.8mm duration of 10 sec.																

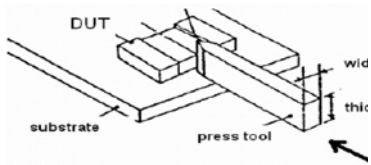
Item	Performance	Test Method and Remarks						
Soderability	More than 95% of the terminal electrode should be covered with solder °	Preheat: 150°C, 60sec. ° Solder: Sn99.5%-Cu0. 5% ° Temperature: 245±5°C ° Flux for lead free: Rosin. 9.5% ° Dip time: 4±1sec ° Depth: completely cover the termination						
Resistance to Soldering Heat		Number of heat cycles: 1 <table border="1" data-bbox="1007 427 1390 562"> <thead> <tr> <th>Temperature (°C)</th> <th>Time(s)</th> <th>Temperature ramp/immersion and emersion rate</th> </tr> </thead> <tbody> <tr> <td>260 ±5(solder temp)</td> <td>10 ±1</td> <td>25mm/s ±6 mm/s</td> </tr> </tbody> </table>	Temperature (°C)	Time(s)	Temperature ramp/immersion and emersion rate	260 ±5(solder temp)	10 ±1	25mm/s ±6 mm/s
Temperature (°C)	Time(s)	Temperature ramp/immersion and emersion rate						
260 ±5(solder temp)	10 ±1	25mm/s ±6 mm/s						
Terminal Strength	Appearance : No damage. Inductance : within±10% of initial value Q : Shall not exceed the specification value. RDC : within ±15% of initial value and shall not exceed the specification value	Preconditioning:Run through IR reflow for 2 times.(IPC/JEDEC J-STD-020DClassification Reflow Profiles With the component mounted on a PCB with the device to be tested, apply a force (>0805:1kg , <=0805:0.5kg)to the side of a device being tested. This force shall be applied for 60 +1 seconds. Also the force shall be applied gradually as not to apply a shock to the component being tested. 						

8. Soldering

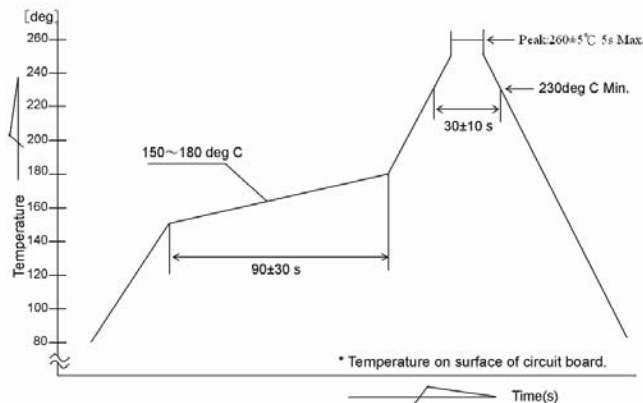

9. Packaging Information

(1) Reel Dimension

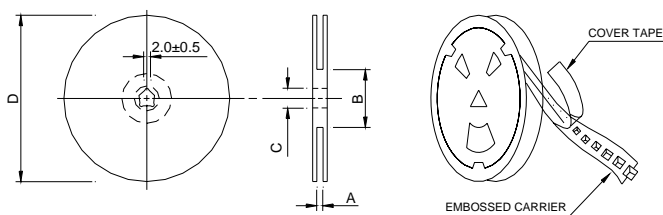

Type	A(mm)	B(mm)	C(mm)	D(mm)
HPC4018B	13.5±1.0	80±2.0	13±0.5	330±3.0

(2) Tape Dimension

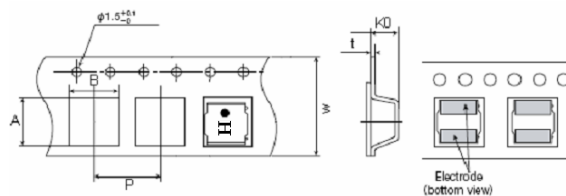

Type	A(mm)	B(mm)	Ko(mm)	P(mm)	W(mm)	t(mm)
HPC4018B	4.3±0.1	4.3±0.1	2.1±0.1	8.0±0.1	12±0.3	0.3±0.1

(3) Packaging Quantity

Type	Chip / Reel
HPC4018B	3500

Application Notice

- Storage Conditions (component level)
To maintain the solderability of terminal electrodes:
 1. TAI-TECH products meet IPC/JEDEC J-STD-020D standard-MSL, level 1.
 2. Temperature and humidity conditions: Less than 40°C and 60% RH.
 3. Recommended products should be used within 12 months form the time of delivery.
 4. The packaging material should be kept where no chlorine or sulfur exists in the air.
- Transportation
 1. Products should be handled with care to avoid damage or contamination from perspiration and skin oils.
 2. The use of tweezers or vacuum pick up is strongly recommended for individual components.
 3. Bulk handling should ensure that abrasion and mechanical shock are minimized.



簽名有效

For Question
Please Contact with SGS
www.tw.sgs.com

測試報告

Test Report

號碼(No.) : CE/2013/C5949 日期(Date) : 2014/01/07 頁數(Page) : 1 of 12

西北臺慶科技股份有限公司 / TAI-TECH ADVANCED ELECTRONICS CO., LTD.



(東莞臺慶精密電子有限公司 / TAI-TECH ADVANCED ELECTRONICS (DONGGUAN) CO. LTD.)

(臺慶精密電子(昆山)有限公司 / TAI-TECH ADVANCED ELECTRONICS (KUN-SHAN) CO. LTD.)

(耀鑽科技股份有限公司 / YOSONIC TECHNOLOGY CO., LTD.)

桃園縣楊梅市幼獅工業區幼四路1號 / NO. 1, YOU 4TH ROAD, YOUTH INDUSTRIAL DISTRICT, YANG-MEI CITY, TAO-YUAN HSIEN, TAIWAN R. O. C.

(廣東省東莞市黃江鎮黃牛埔福祥街2號 / NO. 2, FUXIANG STREET, HUANGNIUPU, HUANGJIANG TOWN, DONGGUAN, GUANGDONG)

(江蘇省昆山市蓬朗昆嘉高科技工業區郭澤路 / GUO-ZE ROAD, KUNJIA HI-TECH INDUSTRIAL PARK, KUN-SHAN, JIANG-SU, CHINA)

(桃園縣中壢市中壢工業區長春六路15號 / NO. 15, CHANGCHUN 6TH RD., JHONGLI CITY, TAOYUAN COUNTY 320, TAIWAN (R. O. C.))

以下測試樣品係由申請廠商所提供及確認 (The following sample(s) was/were submitted and identified by/on behalf of the applicant as):

- 樣品名稱(Sample Description) : SMD POWER INDUCTOR
- 樣品型號(Style/Item No.) : HPC, MDC, FPC, FWP, SPC, SPI, UHP, DFP, TLPC, TLPH, TLI SERIES
- 收件日期(Sample Receiving Date) : 2013/12/30
- 測試期間(Testing Period) : 2013/12/30 TO 2014/01/07

測試結果(Test Results) : 請見下一頁 (Please refer to next pages).

 Troy Chang, Manager-Tech
 Signed for and on behalf of
 SGS TAIWAN LTD
 Chemical Laboratory – Taipei

This document is issued by the Company subject to its General Conditions of Service printed overleaf, available on request or accessible at <http://www.sgs.com/en/Terms-and-Conditions.asp> and, for electronic format documents, subject to Terms and Conditions for Electronic Documents at <http://www.sgs.com/en/Terms-and-Conditions/Terms-Document.asp>. Attention is drawn to the limitation of liability, indemnification and jurisdiction issues defined therein. Any holder of this document is advised that information contained hereon reflects the Company's findings at the time of its intervention only and within the limits of client's instruction, if any. The Company's sole responsibility is to its Client and this document does not exonerate parties to a transaction from exercising all their rights and obligations under the transaction documents. This document cannot be reproduced, except in full, without prior written approval of the Company. Any unauthorized alteration, forgery or falsification of the content or appearance of this document is unlawful and offenders may be prosecuted to the fullest extent of the law. Unless otherwise stated the results shown in this test report refer only to the sample(s) tested.



測試報告

Test Report

號碼(No.) : CE/2013/C5949 日期(Date) : 2014/01/07 頁數(Page) : 2 of 12

西北臺慶科技股份有限公司 / TAI-TECH ADVANCED ELECTRONICS CO., LTD.



(東莞臺慶精密電子有限公司 / TAI-TECH ADVANCED ELECTRONICS (DONGGUAN) CO. LTD.)

(臺慶精密電子(昆山)有限公司 / TAI-TECH ADVANCED ELECTRONICS (KUN-SHAN) CO. LTD.)

(耀鑽科技股份有限公司 / YOSONIC TECHNOLOGY CO., LTD.)

桃園縣楊梅市幼獅工業區幼四路1號 / NO. 1, YOU 4TH ROAD, YOUTH INDUSTRIAL DISTRICT, YANG-MEI CITY, TAO-YUAN HSIEN, TAIWAN R. O. C.

(廣東省東莞市黃江鎮黃牛埔福祥街2號 / NO. 2, FUXIANG STREET, HUANGNIUPU, HUANGJIANG TOWN, DONGGUAN, GUANGDONG)

(江蘇省昆山市蓬朗昆嘉高科技工業區郭澤路 / GUO-ZE ROAD, KUNJIA HI-TECH INDUSTRIAL PARK, KUN-SHAN, JIANG-SU, CHINA)

(桃園縣中壢市中壢工業區長春六路15號 / NO. 15, CHANGCHUN 6TH RD., JHONGLI CITY, TAOYUAN COUNTY 320, TAIWAN (R. O. C.))

測試結果(Test Results)

測試部位(PART NAME)No.1 : 整體混測 (MIXED ALL PARTS)

測試項目 (Test Items)	單位 (Unit)	測試方法 (Method)	方法偵測 極限值 (MDL)	結果 (Result)
				No.1
鎘 / Cadmium (Cd)	mg/kg	參考IEC 62321-5: 2013方法, 以感應耦合電漿原子發射光譜儀檢測. / With reference to IEC 62321-5: 2013 and performed by ICP-AES.	2	n.d.
鉛 / Lead (Pb)	mg/kg	參考IEC 62321-5: 2013方法, 以感應耦合電漿原子發射光譜儀檢測. / With reference to IEC 62321-5: 2013 and performed by ICP-AES.	2	n.d.
汞 / Mercury (Hg)	mg/kg	參考IEC 62321-4: 2013方法, 以感應耦合電漿原子發射光譜儀檢測. / With reference to IEC 62321-4: 2013 and performed by ICP-AES.	2	n.d.
六價鉻 / Hexavalent Chromium Cr(VI)	mg/kg	參考IEC 62321: 2008方法, 以UV-VIS檢測. / With reference to IEC 62321: 2008 and performed by UV-VIS.	2	n.d.

This document is issued by the Company subject to its General Conditions of Service printed overleaf, available on request or accessible at <http://www.sgs.com.tw/Terms-and-Conditions.aspx> and, for electronic format documents, subject to Terms and Conditions for Electronic Documents at <http://www.sgs.com.tw/Terms-and-Conditions/Electronic-Documents.aspx>. Attention is drawn to the limitation of liability, indemnification and jurisdiction issues defined therein. Any holder of this document is advised that information contained hereon reflects the Company's findings at the time of its intervention only and within the limits of client's instruction, if any. The Company's sole responsibility is to its Client and this document does not exonerate parties to a transaction from exercising all their rights and obligations under the transaction documents. This document cannot be reproduced, except in full, without prior written approval of the Company. Any unauthorized alteration, forgery or falsification of the content or appearance of this document is unlawful and offenders may be prosecuted to the fullest extent of the law. Unless otherwise stated the results shown in this test report refer only to the sample(s) tested.



測試報告

Test Report

號碼(No.) : CE/2013/C5949 日期(Date) : 2014/01/07 頁數(Page) : 3 of 12

西北臺慶科技股份有限公司 / TAI-TECH ADVANCED ELECTRONICS CO., LTD.



(東莞臺慶精密電子有限公司 / TAI-TECH ADVANCED ELECTRONICS (DONGGUAN) CO. LTD.)

(臺慶精密電子(昆山)有限公司 / TAI-TECH ADVANCED ELECTRONICS (KUN-SHAN) CO. LTD.)

(耀鑽科技股份有限公司 / YOSONIC TECHNOLOGY CO., LTD.)

桃園縣楊梅市幼獅工業區幼四路1號 / NO. 1, YOU 4TH ROAD, YOUTH INDUSTRIAL DISTRICT, YANG-MEI CITY, TAO-YUAN HSIEN, TAIWAN R. O. C.

(廣東省東莞市黃江鎮黃牛埔福祥街2號 / NO. 2, FUXIANG STREET, HUANGNIUPU, HUANGJIANG TOWN, DONGGUAN, GUANGDONG)

(江蘇省昆山市蓬朗昆嘉高科技工業區郭澤路 / GUO-ZE ROAD, KUNJIA HI-TECH INDUSTRIAL PARK, KUN-SHAN, JIANG-SU, CHINA)

(桃園縣中壢市中壢工業區長春六路15號 / NO. 15, CHANGCHUN 6TH RD., JHONGLI CITY, TAOYUAN COUNTY 320, TAIWAN (R. O. C.))

測試項目 (Test Items)	單位 (Unit)	測試方法 (Method)	方法偵測 極限值 (MDL)	結果 (Result)
				No.1
鄰苯二甲酸甲苯基丁酯 / BBP (Benzyl butyl phthalate) (CAS No.: 85-68-7)	%	參考EN 14372, 以氣相層析/質譜儀檢測之。 / With reference to EN 14372. Analysis was performed by GC/MS.	0.003	n.d.
鄰苯二甲酸二(2-乙基己基)酯 / DEHP (Di- (2-ethylhexyl) phthalate) (CAS No.: 117-81-7)	%	參考EN 14372, 以氣相層析/質譜儀檢測之。 / With reference to EN 14372. Analysis was performed by GC/MS.	0.003	n.d.
鄰苯二甲酸二異癸酯 / DIDP (Di- isodecyl phthalate) (CAS No.: 26761-40-0; 68515-49-1)	%	參考EN 14372, 以氣相層析/質譜儀檢測之。 / With reference to EN 14372. Analysis was performed by GC/MS.	0.01	n.d.
鄰苯二甲酸二異壬酯 / DINP (Di- isononyl phthalate) (CAS No.: 28553-12-0; 68515-48-0)	%	參考EN 14372, 以氣相層析/質譜儀檢測之。 / With reference to EN 14372. Analysis was performed by GC/MS.	0.01	n.d.
鄰苯二甲酸二正辛酯 / DNOP (Di-n- octyl phthalate) (CAS No.: 117- 84-0)	%	參考EN 14372, 以氣相層析/質譜儀檢測之。 / With reference to EN 14372. Analysis was performed by GC/MS.	0.003	n.d.
鄰苯二甲酸二丁酯 / DBP (Dibutyl phthalate) (CAS No.: 84-74-2)	%	參考EN 14372, 以氣相層析/質譜儀檢測之。 / With reference to EN 14372. Analysis was performed by GC/MS.	0.003	n.d.
鄰苯二甲酸二異丁酯 / DIBP (Di- isobutyl phthalate) (CAS No.: 84- 69-5)	%	參考EN 14372, 以氣相層析/質譜儀檢測之。 / With reference to EN 14372. Analysis was performed by GC/MS.	0.003	n.d.

This document is issued by the Company subject to its General Conditions of Service printed overleaf, available on request or accessible at <http://www.sgs.com/en/Terms-and-Conditions.aspx> and, for electronic format documents, subject to Terms and Conditions for Electronic Documents at <http://www.sgs.com/en/Terms-and-Conditions/Electronic-Documents.aspx>. Attention is drawn to the limitation of liability, indemnification and jurisdiction issues defined therein. Any holder of this document is advised that information contained hereon reflects the Company's findings at the time of its intervention only and within the limits of client's instruction, if any. The Company's sole responsibility is to its Client and this document does not exonerate parties to a transaction from exercising all their rights and obligations under the transaction documents. This document cannot be reproduced, except in full, without prior written approval of the Company. Any unauthorized alteration, forgery or falsification of the content or appearance of this document is unlawful and offenders may be prosecuted to the fullest extent of the law. Unless otherwise stated the results shown in this test report refer only to the sample(s) tested.



測試報告

Test Report

號碼(No.) : CE/2013/C5949 日期(Date) : 2014/01/07 頁數(Page) : 4 of 12

西北臺慶科技股份有限公司 / TAI-TECH ADVANCED ELECTRONICS CO., LTD.



(東莞臺慶精密電子有限公司 / TAI-TECH ADVANCED ELECTRONICS (DONGGUAN) CO. LTD.)

(臺慶精密電子(昆山)有限公司 / TAI-TECH ADVANCED ELECTRONICS (KUN-SHAN) CO. LTD.)

(耀鑽科技股份有限公司 / YOSONIC TECHNOLOGY CO., LTD.)

桃園縣楊梅市幼獅工業區幼四路1號 / NO. 1, YOU 4TH ROAD, YOUTH INDUSTRIAL DISTRICT, YANG-MEI CITY, TAO-YUAN HSIEN, TAIWAN R. O. C.

(廣東省東莞市黃江鎮黃牛埔福祥街2號 / NO. 2, FUXIANG STREET, HUANGNIUPU, HUANGJIANG TOWN, DONGGUAN, GUANGDONG)

(江蘇省昆山市蓬朗昆嘉高科技工業區郭澤路 / GUO-ZE ROAD, KUNJIA HI-TECH INDUSTRIAL PARK, KUN-SHAN, JIANG-SU, CHINA)

(桃園縣中壢市中壢工業區長春六路15號 / NO. 15, CHANGCHUN 6TH RD., JHONGLI CITY, TAOYUAN COUNTY 320, TAIWAN (R. O. C.))

測試項目 (Test Items)	單位 (Unit)	測試方法 (Method)	方法偵測 極限值 (MDL)	結果 (Result)
				No.1
六溴環十二烷及所有主要被辨別出的異構物 / Hexabromocyclododecane (HBCDD) and all major diastereoisomers identified (α -HBCDD, β -HBCDD, γ -HBCDD) (CAS No.: 25637-99-4 and 3194-55-6 (134237-51-7, 134237-50-6, 134237-52-8))	mg/kg	參考IEC 62321: 2008方法, 以氣相層析/質譜儀檢測. / With reference to IEC 62321: 2008 method. Analysis was performed by GC/MS.	5	n.d.
多溴聯苯總和 / Sum of PBBs	mg/kg	參考IEC 62321: 2008方法, 以氣相層析/質譜儀檢測. / With reference to IEC 62321: 2008 and performed by GC/MS.	-	n.d.
一溴聯苯 / Monobromobiphenyl	mg/kg		5	n.d.
二溴聯苯 / Dibromobiphenyl	mg/kg		5	n.d.
三溴聯苯 / Tribromobiphenyl	mg/kg		5	n.d.
四溴聯苯 / Tetrabromobiphenyl	mg/kg		5	n.d.
五溴聯苯 / Pentabromobiphenyl	mg/kg		5	n.d.
六溴聯苯 / Hexabromobiphenyl	mg/kg		5	n.d.
七溴聯苯 / Heptabromobiphenyl	mg/kg		5	n.d.
八溴聯苯 / Octabromobiphenyl	mg/kg		5	n.d.
九溴聯苯 / Nonabromobiphenyl	mg/kg		5	n.d.
十溴聯苯 / Decabromobiphenyl	mg/kg	5	n.d.	

This document is issued by the Company subject to its General Conditions of Service printed overleaf, available on request or accessible at <http://www.sgs.com.tw/Terms-and-Conditions.aspx> and, for electronic format documents, subject to Terms and Conditions for Electronic Documents at <http://www.sgs.com.tw/Terms-and-Conditions-for-electronic-documents.aspx>. Attention is drawn to the limitation of liability, indemnification and jurisdiction issues defined therein. Any holder of this document is advised that information contained hereon reflects the Company's findings at the time of its intervention only and within the limits of client's instruction, if any. The Company's sole responsibility is to its Client and this document does not exonerate parties to a transaction from exercising all their rights and obligations under the transaction documents. This document cannot be reproduced, except in full, without prior written approval of the Company. Any unauthorized alteration, forgery or falsification of the content or appearance of this document is unlawful and offenders may be prosecuted to the fullest extent of the law. Unless otherwise stated the results shown in this test report refer only to the sample(s) tested.



測試報告

Test Report

號碼(No.) : CE/2013/C5949 日期(Date) : 2014/01/07 頁數(Page) : 5 of 12

西北臺慶科技股份有限公司 / TAI-TECH ADVANCED ELECTRONICS CO., LTD.



(東莞臺慶精密電子有限公司 / TAI-TECH ADVANCED ELECTRONICS (DONGGUAN) CO. LTD.)

(臺慶精密電子(昆山)有限公司 / TAI-TECH ADVANCED ELECTRONICS (KUN-SHAN) CO. LTD.)

(耀鑽科技股份有限公司 / YOSONIC TECHNOLOGY CO., LTD.)

桃園縣楊梅市幼獅工業區幼四路1號 / NO. 1, YOU 4TH ROAD, YOUTH INDUSTRIAL DISTRICT, YANG-MEI CITY, TAO-YUAN HSIEN, TAIWAN R. O. C.

(廣東省東莞市黃江鎮黃牛埔福祥街2號 / NO. 2, FUXIANG STREET, HUANGNIUPU, HUANGJIANG TOWN, DONGGUAN, GUANGDONG)

(江蘇省昆山市蓬朗昆嘉高科技工業區郭澤路 / GUO-ZE ROAD, KUNJIA HI-TECH INDUSTRIAL PARK, KUN-SHAN, JIANG-SU, CHINA)

(桃園縣中壢市中壢工業區長春六路15號 / NO. 15, CHANGCHUN 6TH RD., JHONGLI CITY, TAOYUAN COUNTY 320, TAIWAN (R. O. C.))

測試項目 (Test Items)	單位 (Unit)	測試方法 (Method)	方法偵測 極限值 (MDL)	結果 (Result)
				No.1
多溴聯苯醚總和 / Sum of PBDEs	mg/kg	參考IEC 62321: 2008方法, 以氣相層析/質譜儀檢測. / With reference to IEC 62321: 2008 and performed by GC/MS.	-	n.d.
一溴聯苯醚 / Monobromodiphenyl ether	mg/kg		5	n.d.
二溴聯苯醚 / Dibromodiphenyl ether	mg/kg		5	n.d.
三溴聯苯醚 / Tribromodiphenyl ether	mg/kg		5	n.d.
四溴聯苯醚 / Tetrabromodiphenyl ether	mg/kg		5	n.d.
五溴聯苯醚 / Pentabromodiphenyl ether	mg/kg		5	n.d.
六溴聯苯醚 / Hexabromodiphenyl ether	mg/kg		5	n.d.
七溴聯苯醚 / Heptabromodiphenyl ether	mg/kg		5	n.d.
八溴聯苯醚 / Octabromodiphenyl ether	mg/kg		5	n.d.
九溴聯苯醚 / Nonabromodiphenyl ether	mg/kg		5	n.d.
十溴聯苯醚 / Decabromodiphenyl ether	mg/kg	5	n.d.	
鹵素 / Halogen				
鹵素 (氟) / Halogen-Fluorine (F) (CAS No.: 14762-94-8)	mg/kg	參考BS EN 14582:2007, 以離子層析儀分析. / With reference to BS EN 14582:2007. Analysis was performed by IC.	50	n.d.
鹵素 (氯) / Halogen-Chlorine (Cl) (CAS No.: 22537-15-1)	mg/kg		50	n.d.
鹵素 (溴) / Halogen-Bromine (Br) (CAS No.: 10097-32-2)	mg/kg		50	n.d.
鹵素 (碘) / Halogen-Iodine (I) (CAS No.: 14362-44-8)	mg/kg		50	n.d.

This document is issued by the Company subject to its General Conditions of Service printed overleaf, available on request or accessible at <http://www.sgs.com/ter/terms-and-conditions.asp> and, for electronic format documents, subject to Terms and Conditions for Electronic Documents at <http://www.sgs.com/ter/terms-and-conditions/terms-and-conditions.asp>. Attention is drawn to the limitation of liability, indemnification and jurisdiction issues defined therein. Any holder of this document is advised that information contained hereon reflects the Company's findings at the time of its intervention only and within the limits of client's instruction, if any. The Company's sole responsibility is to its Client and this document does not exonerate parties to a transaction from exercising all their rights and obligations under the transaction documents. This document cannot be reproduced, except in full, without prior written approval of the Company. Any unauthorized alteration, forgery or falsification of the content or appearance of this document is unlawful and offenders may be prosecuted to the fullest extent of the law. Unless otherwise stated the results shown in this test report refer only to the sample(s) tested.



測試報告

Test Report

號碼(No.) : CE/2013/C5949 日期(Date) : 2014/01/07 頁數(Page) : 6 of 12

西北臺慶科技股份有限公司 / TAI-TECH ADVANCED ELECTRONICS CO., LTD.



(東莞臺慶精密電子有限公司 / TAI-TECH ADVANCED ELECTRONICS (DONGGUAN) CO. LTD.)

(臺慶精密電子(昆山)有限公司 / TAI-TECH ADVANCED ELECTRONICS (KUN-SHAN) CO. LTD.)

(耀鑽科技股份有限公司 / YOSONIC TECHNOLOGY CO., LTD.)

桃園縣楊梅市幼獅工業區幼四路1號 / NO. 1, YOU 4TH ROAD, YOUTH INDUSTRIAL DISTRICT, YANG-MEI CITY, TAO-YUAN HSIEN, TAIWAN R. O. C.

(廣東省東莞市黃江鎮黃牛埔福祥街2號 / NO. 2, FUXIANG STREET, HUANGNIUPU, HUANGJIANG TOWN, DONGGUAN, GUANGDONG)

(江蘇省昆山市蓬朗昆嘉高科技工業區郭澤路 / GUO-ZE ROAD, KUNJIA HI-TECH INDUSTRIAL PARK, KUN-SHAN, JIANG-SU, CHINA)

(桃園縣中壢市中壢工業區長春六路15號 / NO. 15, CHANGCHUN 6TH RD., JHONGLI CITY, TAOYUAN COUNTY 320, TAIWAN (R. O. C.))

備註(Note) :

1. mg/kg = ppm ; 0.1wt% = 1000ppm
2. n.d. = Not Detected (未檢出)
3. MDL = Method Detection Limit (方法偵測極限值)
4. "-" = Not Regulated (無規格值)
5. 樣品的測試是基於申請人要求混合測試, 報告中的混合測試結果不代表其中個別單一材質的含量. (The samples was/were analyzed on behalf of the applicant as mixing sample in one testing. The above results was/were only given as the informality value.)

This document is issued by the Company subject to its General Conditions of Service printed overleaf, available on request or accessible at <http://www.sgs.com/en/Terms-and-Conditions.aspx> and, for electronic format documents, subject to Terms and Conditions for Electronic Documents at <http://www.sgs.com/en/Terms-and-Conditions/Terms-Document.aspx>. Attention is drawn to the limitation of liability, indemnification and jurisdiction issues defined therein. Any holder of this document is advised that information contained hereon reflects the Company's findings at the time of its intervention only and within the limits of client's instruction, if any. The Company's sole responsibility is to its Client and this document does not exonerate parties to a transaction from exercising all their rights and obligations under the transaction documents. This document cannot be reproduced, except in full, without prior written approval of the Company. Any unauthorized alteration, forgery or falsification of the content or appearance of this document is unlawful and offenders may be prosecuted to the fullest extent of the law. Unless otherwise stated the results shown in this test report refer only to the sample(s) tested.

測試報告 Test Report

號碼(No.) : CE/2013/C5949 日期(Date) : 2014/01/07 頁數(Page) : 7 of 12

西北臺慶科技股份有限公司 / TAI-TECH ADVANCED ELECTRONICS CO., LTD.

(東莞臺慶精密電子有限公司 / TAI-TECH ADVANCED ELECTRONICS (DONGGUAN) CO. LTD.)

(臺慶精密電子(昆山)有限公司 / TAI-TECH ADVANCED ELECTRONICS (KUN-SHAN) CO. LTD.)

(耀鑽科技股份有限公司 / YOSONIC TECHNOLOGY CO., LTD.)

桃園縣楊梅市幼獅工業區幼四路1號 / NO. 1, YOU 4TH ROAD, YOUTH INDUSTRIAL DISTRICT, YANG-MEI CITY, TAO-YUAN HSIEN, TAIWAN R. O. C.

(廣東省東莞市黃江鎮黃牛埔福祥街2號 / NO. 2, FUXIANG STREET, HUANGNIUPU, HUANGJIANG TOWN, DONGGUAN, GUANGDONG)

(江蘇省昆山市蓬朗昆嘉高科技工業區郭澤路 / GUO-ZE ROAD, KUNJIA HI-TECH INDUSTRIAL PARK, KUN-SHAN, JIANG-SU, CHINA)

(桃園縣中壢市中壢工業區長春六路15號 / NO. 15, CHANGCHUN 6TH RD., JHONGLI CITY, TAOYUAN COUNTY 320, TAIWAN (R. O. C.))

- 1) 根據以下的流程圖之條件，樣品已完全溶解。(六價鉻測試方法除外) / These samples were dissolved totally by pre-conditioning method according to below flow chart. (Cr⁶⁺ test method excluded)
- 2) 測試人員：楊登偉 / Name of the person who made measurement: Climbgreat Yang
- 3) 測試負責人：張啓興 / Name of the person in charge of measurement: Troy Chang

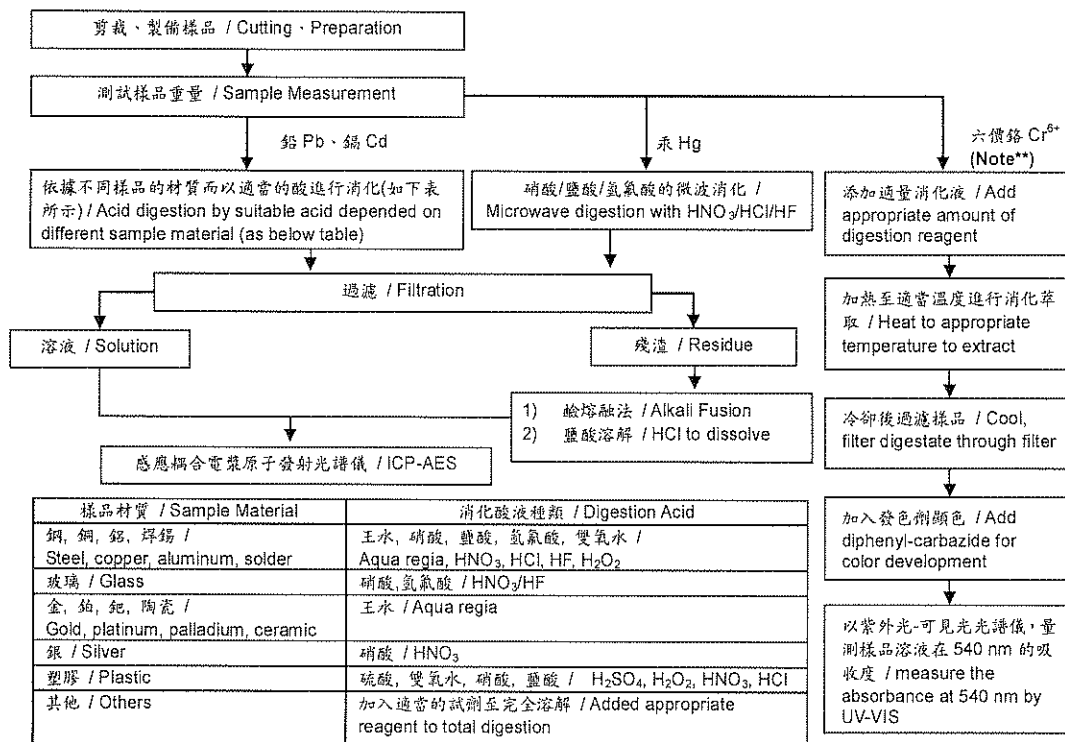

Note** (For IEC 62321)

- (1) 針對非金屬材料加入鹼性消化液，加熱至 90-95℃ 萃取。 / For non-metallic material, add alkaline digestion reagent and heat to 90-95 °C.
- (2) 針對金屬材料加入純水，加熱至沸騰萃取。 / For metallic material, add pure water and heat to boiling.



測試報告

Test Report

號碼(No.) : CE/2013/C5949 日期(Date) : 2014/01/07 頁數(Page) : 8 of 12

西北臺慶科技股份有限公司 / TAI-TECH ADVANCED ELECTRONICS CO., LTD.

(東莞臺慶精密電子有限公司 / TAI-TECH ADVANCED ELECTRONICS (DONGGUAN) CO. LTD.)

(臺慶精密電子(昆山)有限公司 / TAI-TECH ADVANCED ELECTRONICS (KUN-SHAN) CO. LTD.)

(耀鑽科技股份有限公司 / YOSONIC TECHNOLOGY CO., LTD.)

桃園縣楊梅市幼獅工業區幼四路1號 / NO. 1, YOU 4TH ROAD, YOUTH INDUSTRIAL DISTRICT, YANG-MEI CITY, TAO-YUAN HSIEN, TAIWAN R. O. C.

(廣東省東莞市黃江鎮黃牛埔福祥街2號 / NO. 2, FUXIANG STREET, HUANGNIUPU, HUANGJIANG TOWN, DONGGUAN, GUANGDONG)

(江蘇省昆山市蓬朗昆嘉高科技工業區郭澤路 / GUO-ZE ROAD, KUNJIA HI-TECH INDUSTRIAL PARK, KUN-SHAN, JIANG-SU, CHINA)

(桃園縣中壢市中壢工業區長春六路15號 / NO. 15, CHANGCHUN 6TH RD., JHONGLI CITY, TAOYUAN COUNTY 320, TAIWAN (R. O. C.))



多溴聯苯/多溴聯苯醚分析流程圖 / PBB/PBDE analytical FLOW CHART

- 測試人員：翁賜彬 / Name of the person who made measurement: Roman Wong
- 測試負責人：張啓興 / Name of the person in charge of measurement: Troy Chang

初次測試程序 / First testing process —————>

選擇性篩檢程序 / Optional screen process>

確認程序 / Confirmation process - - ->

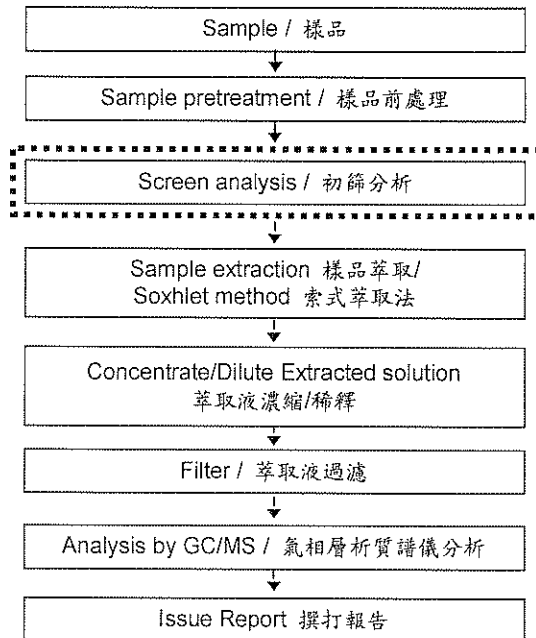

This document is issued by the Company subject to its General Conditions of Service printed overleaf, available on request or accessible at <http://www.sgs.com/en/terms-and-conditions.aspx> and, for electronic format documents, subject to Terms and Conditions for Electronic Documents at <http://www.sgs.com/en/terms-and-conditions/terms-and-conditions.aspx>. Attention is drawn to the limitation of liability, indemnification and jurisdiction issues defined therein. Any holder of this document is advised that information contained hereon reflects the Company's findings at the time of its intervention only and within the limits of client's instruction, if any. The Company's sole responsibility is to its Client and this document does not exonerate parties to a transaction from exercising all their rights and obligations under the transaction documents. This document cannot be reproduced, except in full, without prior written approval of the Company. Any unauthorized alteration, forgery or falsification of the content or appearance of this document is unlawful and offenders may be prosecuted to the fullest extent of the law. Unless otherwise stated the results shown in this test report refer only to the sample(s) tested.



測試報告

Test Report

號碼(No.) : CE/2013/C5949 日期(Date) : 2014/01/07 頁數(Page) : 9 of 12

西北臺慶科技股份有限公司 / TAI-TECH ADVANCED ELECTRONICS CO., LTD.



(東莞臺慶精密電子有限公司 / TAI-TECH ADVANCED ELECTRONICS (DONGGUAN) CO. LTD.)

(臺慶精密電子(昆山)有限公司 / TAI-TECH ADVANCED ELECTRONICS (KUN-SHAN) CO. LTD.)

(耀鑽科技股份有限公司 / YOSONIC TECHNOLOGY CO., LTD.)

桃園縣楊梅市幼獅工業區幼四路1號 / NO. 1, YOU 4TH ROAD, YOUTH INDUSTRIAL DISTRICT, YANG-MEI CITY, TAO-YUAN HSIEN. TAIWAN R. O. C.

(廣東省東莞市黃江鎮黃牛埔福祥街2號 / NO. 2, FUXIANG STREET, HUANGNIUPU, HUANGJIANG TOWN, DONGGUAN, GUANGDONG)

(江蘇省昆山市蓬朗昆嘉高科技工業區郭澤路 / GUO-ZE ROAD, KUNJIA HI-TECH INDUSTRIAL PARK, KUN-SHAN, JIANG-SU, CHINA)

(桃園縣中壢市中壢工業區長春六路15號 / NO. 15, CHANGCHUN 6TH RD., JHONGLI CITY, TAOYUAN COUNTY 320, TAIWAN (R. O. C.))

六溴環十二烷分析流程圖 / HBCDD analytical flow chart

- 測試人員：翁賜彬 / Name of the person who made measurement: Roman Wong
- 測試負責人：張啓興 / Name of the person in charge of measurement: Troy Chang

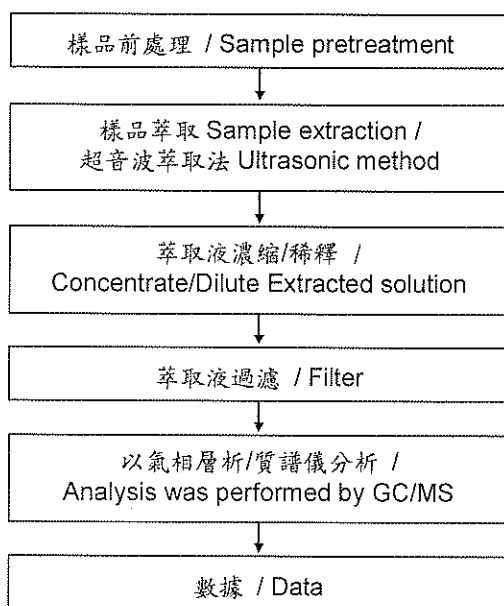

This document is issued by the Company subject to its General Conditions of Service printed overleaf, available on request or accessible at <http://www.sgs.com/en/terms-and-conditions.aspx> and, for electronic format documents, subject to Terms and Conditions for Electronic Documents at <http://www.sgs.com/en/terms-and-conditions/epd/epd-document.aspx>. Attention is drawn to the limitation of liability, indemnification and jurisdiction issues defined therein. Any holder of this document is advised that information contained hereon reflects the Company's findings at the time of its intervention only and within the limits of client's instruction, if any. The Company's sole responsibility is to its Client and this document does not exonerate parties to a transaction from exercising all their rights and obligations under the transaction documents. This document cannot be reproduced, except in full, without prior written approval of the Company. Any unauthorized alteration, forgery or falsification of the content or appearance of this document is unlawful and offenders may be prosecuted to the fullest extent of the law. Unless otherwise stated the results shown in this test report refer only to the sample(s) tested.

測試報告

Test Report

號碼(No.) : CE/2013/C5949 日期(Date) : 2014/01/07 頁數(Page) : 10 of 12

西北臺慶科技股份有限公司 / TAI-TECH ADVANCED ELECTRONICS CO., LTD.



(東莞臺慶精密電子有限公司 / TAI-TECH ADVANCED ELECTRONICS (DONGGUAN) CO. LTD.)

(臺慶精密電子(昆山)有限公司 / TAI-TECH ADVANCED ELECTRONICS (KUN-SHAN) CO. LTD.)

(耀鑽科技股份有限公司 / YOSONIC TECHNOLOGY CO., LTD.)

桃園縣楊梅市幼獅工業區幼四路1號 / NO. 1, YOU 4TH ROAD, YOUTH INDUSTRIAL DISTRICT, YANG-MEI CITY, TAO-YUAN HSIEN, TAIWAN R. O. C.

(廣東省東莞市黃江鎮黃牛埔福祥街2號 / NO. 2, FUXIANG STREET, HUANGNIUPU, HUANGJIANG TOWN, DONGGUAN, GUANGDONG)

(江蘇省昆山市蓬朗昆嘉高科技工業區郭澤路 / GUO-ZE ROAD, KUNJIA HI-TECH INDUSTRIAL PARK, KUN-SHAN, JIANG-SU, CHINA)

(桃園縣中壢市中壢工業區長春六路15號 / NO. 15, CHANGCHUN 6TH RD., JHONGLI CITY, TAOYUAN COUNTY 320, TAIWAN (R. O. C.))

可塑劑分析流程圖 / Analytical flow chart of phthalate content

- 測試人員：翁賜彬 / Name of the person who made measurement: Roman Wong
- 測試負責人：張啓興 / Name of the person in charge of measurement: Troy Chang

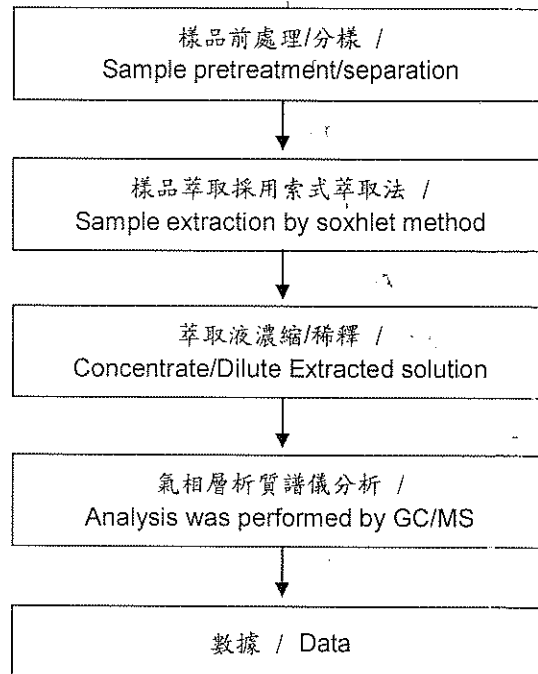

This document is issued by the Company subject to its General Conditions of Service printed overleaf, available on request or accessible at <http://www.sgs.com/en/terms-and-conditions.aspx> and, for electronic format documents, subject to Terms and Conditions for Electronic Documents at <http://www.sgs.com/en/terms-and-conditions/terms-and-conditions.aspx>. Attention is drawn to the limitation of liability, indemnification and jurisdiction issues defined therein. Any holder of this document is advised that information contained hereon reflects the Company's findings at the time of its intervention only and within the limits of client's instruction, if any. The Company's sole responsibility is to its Client and this document does not exonerate parties to a transaction from exercising all their rights and obligations under the transaction documents. This document cannot be reproduced, except in full, without prior written approval of the Company. Any unauthorized alteration, forgery or falsification of the content or appearance of this document is unlawful and offenders may be prosecuted to the fullest extent of the law. Unless otherwise stated the results shown in this test report refer only to the sample(s) tested.



測試報告

Test Report

號碼(No.) : CE/2013/C5949 日期(Date) : 2014/01/07 頁數(Page) : 11 of 12

西北臺慶科技股份有限公司 / TAI-TECH ADVANCED ELECTRONICS CO., LTD.



(東莞臺慶精密電子有限公司 / TAI-TECH ADVANCED ELECTRONICS (DONGGUAN) CO. LTD.)

(臺慶精密電子(昆山)有限公司 / TAI-TECH ADVANCED ELECTRONICS (KUN-SHAN) CO. LTD.)

(耀鑽科技股份有限公司 / YOSONIC TECHNOLOGY CO., LTD.)

桃園縣楊梅市幼獅工業區幼四路1號 / NO. 1, YOU 4TH ROAD, YOUTH INDUSTRIAL DISTRICT, YANG-MEI CITY, TAO-YUAN HSIEN, TAIWAN R. O. C.

(廣東省東莞市黃江鎮黃牛埔福祥街2號 / NO. 2, FUXIANG STREET, HUANGNIUPU, HUANGJIANG TOWN, DONGGUAN, GUANGDONG)

(江蘇省昆山市蓬朗昆嘉高科技工業區郭澤路 / GUO-ZE ROAD, KUNJIA HI-TECH INDUSTRIAL PARK, KUN-SHAN, JIANG-SU, CHINA)

(桃園縣中壢市中壢工業區長春六路15號 / NO. 15, CHANGCHUN 6TH RD., JHONGLI CITY, TAOYUAN COUNTY 320, TAIWAN (R. O. C.))

鹵素分析流程圖 / Analytical flow chart of halogen content

- 測試人員：陳恩臻 / Name of the person who made measurement: Rita Chen
- 測試負責人：張啓興 / Name of the person in charge of measurement: Troy Chang

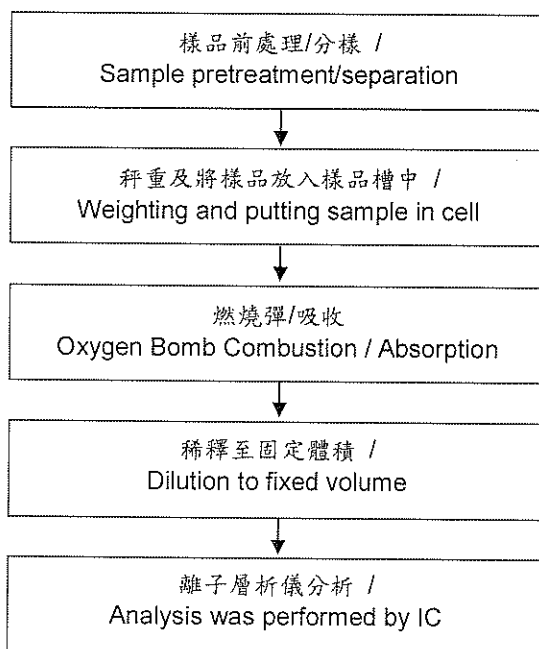

This document is issued by the Company subject to its General Conditions of Service printed overleaf, available on request or accessible at <http://www.sgs.com.tw/en/terms-and-conditions.aspx> and, for electronic format documents, subject to Terms and Conditions for Electronic Documents at <http://www.sgs.com.tw/en/terms-and-conditions/terms-and-conditions.aspx>. Attention is drawn to the limitation of liability, indemnification and jurisdiction issues defined therein. Any holder of this document is advised that information contained hereon reflects the Company's findings at the time of its intervention only and within the limits of client's instruction, if any. The Company's sole responsibility is to its Client and this document does not exonerate parties to a transaction from exercising all their rights and obligations under the transaction documents. This document cannot be reproduced, except in full, without prior written approval of the Company. Any unauthorized alteration, forgery or falsification of the content or appearance of this document is unlawful and offenders may be prosecuted to the fullest extent of the law. Unless otherwise stated the results shown in this test report refer only to the sample(s) tested.

測試報告

Test Report

號碼(No.) : CE/2013/C5949 日期(Date) : 2014/01/07 頁數(Page) : 12 of 12

西北臺慶科技股份有限公司 / TAI-TECH ADVANCED ELECTRONICS CO., LTD.



(東莞臺慶精密電子有限公司 / TAI-TECH ADVANCED ELECTRONICS (DONGGUAN) CO. LTD.)

(臺慶精密電子(昆山)有限公司 / TAI-TECH ADVANCED ELECTRONICS (KUN-SHAN) CO. LTD.)

(耀鑽科技股份有限公司 / YOSONIC TECHNOLOGY CO., LTD.)

桃園縣楊梅市幼獅工業區幼四路1號 / NO. 1, YOU 4TH ROAD, YOUTH INDUSTRIAL DISTRICT, YANG-MEI CITY, TAO-YUAN HSIEN. TAIWAN R. O. C.

(廣東省東莞市黃江鎮黃牛埔福祥街2號 / NO. 2, FUXIANG STREET, HUANGNIUPU, HUANGJIANG TOWN, DONGGUAN, GUANGDONG)

(江蘇省昆山市蓬朗昆嘉高科技工業區郭澤路 / GUO-ZE ROAD, KUNJIA HI-TECH INDUSTRIAL PARK, KUN-SHAN, JIANG-SU, CHINA)

(桃園縣中壢市中壢工業區長春六路15號 / NO. 15, CHANGCHUN 6TH RD., JHONGLI CITY, TAOYUAN COUNTY 320, TAIWAN (R. O. C.))

* 照片中如有箭頭標示，則表示為實際檢測之樣品/部位。*

(The tested sample / part is marked by an arrow if it's shown on the photo.)

CE/2013/C5949

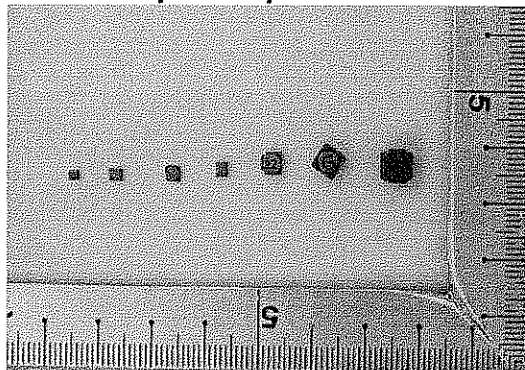

CE/2013/C5949

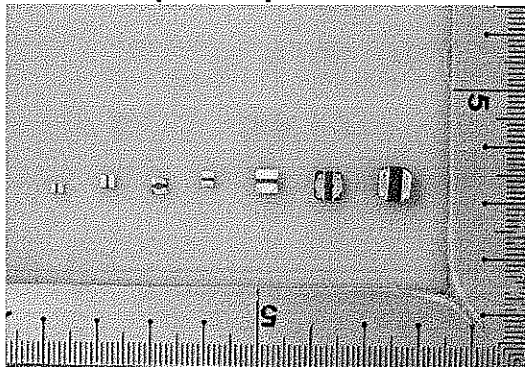

** 報告結尾 (End of Report) **

This document is issued by the Company subject to its General Conditions of Service printed overleaf, available on request or accessible at <http://www.sgs.com/ta/Forms-and-Conditions.aspx> and, for electronic format documents, subject to Terms and Conditions for Electronic Documents at <http://www.sgs.com/ta/Terms-and-Conditions/Forms-and-Conditions.aspx>. Attention is drawn to the limitation of liability, indemnification and jurisdiction issues defined therein. Any holder of this document is advised that information contained herein reflects the Company's findings at the time of its intervention only and within the limits of client's instruction, if any. The Company's sole responsibility is to its Client and this document does not exonerate parties to a transaction from exercising all their rights and obligations under the transaction documents. This document cannot be reproduced, except in full, without prior written approval of the Company. Any unauthorized alteration, forgery or falsification of the content or appearance of this document is unlawful and offenders may be prosecuted to the fullest extent of the law. Unless otherwise stated the results shown in this test report refer only to the sample(s) tested.

X-ON Electronics

Largest Supplier of Electrical and Electronic Components

Click to view similar products for [Fixed Inductors](#) category:

Click to view products by [TAITEC](#) manufacturer:

Other Similar products are found below :

[MLZ1608M6R8WTD25](#) [MLZ1608N6R8LT000](#) [MLZ1608N3R3LTD25](#) [MLZ1608N3R3LT000](#) [MLZ1608N150LT000](#)

[MLZ1608M150WTD25](#) [MLZ1608M3R3WTD25](#) [MLZ1608M3R3WT000](#) [MLZ1608M150WT000](#) [MLZ1608A1R5WT000](#)

[MLZ1608N1R5LT000](#) [B82432C1333K000](#) [PCMB053T-1R0MS](#) [PCMB053T-1R5MS](#) [PCMB104T-1R5MS](#) [CR32NP-100KC](#) [CR32NP-](#)

[151KC](#) [CR32NP-180KC](#) [CR32NP-181KC](#) [CR32NP-1R5MC](#) [CR32NP-390KC](#) [CR32NP-3R9MC](#) [CR32NP-680KC](#) [CR32NP-820KC](#)

[CR32NP-8R2MC](#) [CR43NP-390KC](#) [CR43NP-560KC](#) [CR43NP-680KC](#) [CR54NP-181KC](#) [CR54NP-470LC](#) [CR54NP-820KC](#) [CR54NP-8R5MC](#)

[MGDQ4-00004-P](#) [MGDU1-00016-P](#) [MHL1ECTTP18NJ](#) [MHL1JCTTD12NJ](#) [PE-51506NL](#) [PE-53601NL](#) [PE-53630NL](#) [PE-53824SNLT](#) [PE-](#)

[62892NL](#) [PE-92100NL](#) [PG0434.801NLT](#) [PG0936.113NLT](#) [PM06-2N7](#) [PM06-39NJ](#) [HC2LP-R47-R](#) [HC2-R47-R](#) [HC3-2R2-R](#) [HC8-1R2-R](#)