

TABLE 1						MATED HEIGHT WITH QSE-01
STYLE	"B"	"C"	BODY	GROUND PLANE	TERMINAL	
-01	.1680 [4.267]	.1600 [4.064]	QTE-20-01-D-XX	T-1G1-01-XXX	T-1S39-01-XXX	.197 [5.00] REF
-02	.2861 [7.267]	.2781 [7.064]	QTE-20-02-D-XX	T-1G1-02-XXX	T-1S59-02-XXX	.315 [8.00] REF
-03	.4042 [10.267]	.3962 [10.063]	QTE-20-03-D-XX	T-1G1-03-XXX	T-1S39-03-XXX	.433 [11.00] REF

TABLE 3		
No OF POS	"A"	"D"
-020	.788 [20.00]	.728 [18.48]
-040	1.575 [40.01]	1.515 [38.48]
-060	2.363 [60.01]	2.303 [58.48]
*-080	3.150 [80.01]	3.090 [78.49]
*-100	3.938 [100.01]	3.878 [98.49]

\* = (SEE NOTE 11 & 14)

TABLE 2	
No OF POSITIONS	COPLANARITY INCLUDING GP
-020 THRU -060	.004 [0.10]
*-080 THRU *-100	.006 [0.15]

\* = (SEE NOTE 11 & 14)

DO NOT SCALE FROM THIS PRINT

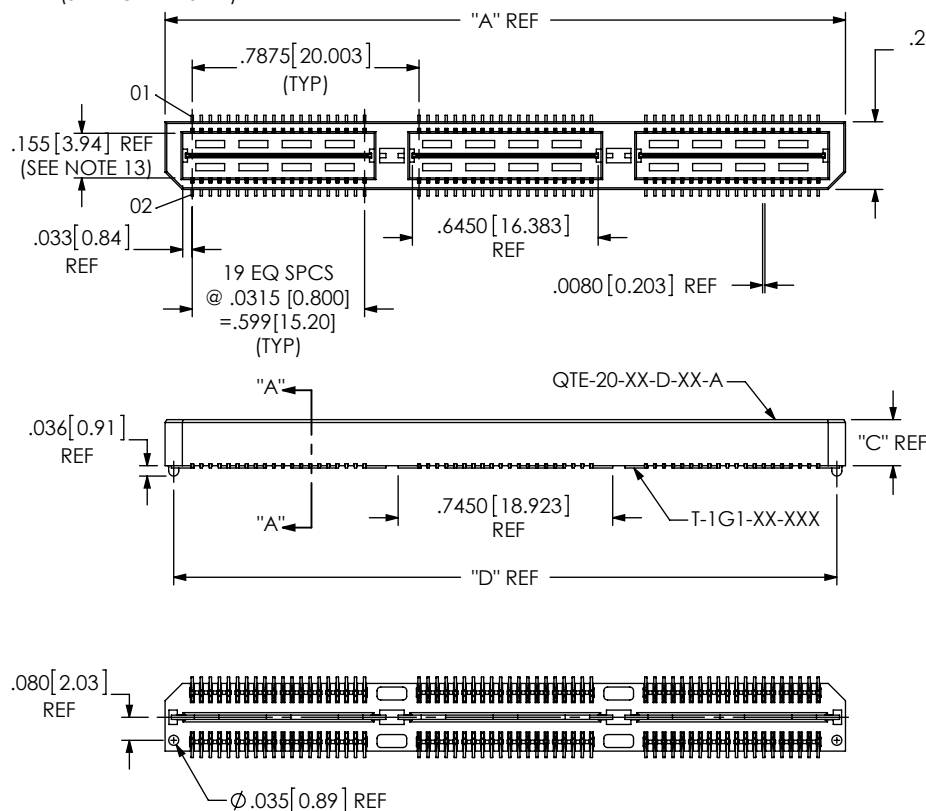

NOTES:

1.  $\varnothing$  REPRESENTS A CRITICAL DIMENSION.
2. MINIMUM TERMINAL RETENTION: 8 OZ.
3. MINIMUM GROUND PLANE RETENTION: 1 LB.
4. PARTS TO BE MOLDED TO POSITION.
5. MAXIMUM VARIANCE OF .002 [0.05].
6. DIMENSION APPLIES TO TERMINALS AND GROUND PLANE.
7. T-1SXX-XX-L CAN BE SUBSTITUTED FOR T-1SXX-XX-F.
8. NOTE DELETED.
9. GROUND PLANE PRESS HEIGHT MUST BE .003[0.08] LESS THAN THE MAX HEIGHT OR .001[0.03] GREATER THAN THE MINIMUM HEIGHT OF THE TERMINALS.
10. T-1R36 RETENTION TO BODY TO BE 1.0 LBF.
11. FOR NEW APPLICATIONS REQUIRING THESE POSITIONS, PLEASE CONTACT SAMTEC INTERCONNECT PROCESSING GROUP.
12. DUE TO THE HIGH AMOUNT OF INSERTION FORCE NEEDED, THE -LC OPTION IS NOT COMPATIBLE WITH AUTO PLACEMENT. SAMTEC RECOMMENDS MANUAL PLACEMENT FOR ALL ASSEMBLIES WITH THE -LC OPTION.
13. PIN CAN EXTEND PAST WALL .003[0.08] MAX.
14. AVAILABLE FOR EXISTING CUSTOMERS ONLY.

FIG 1

-A: ALIGNMENT PIN OPTION (QTE-060-01-XXX-D-A SHOWN) (STYLE -01, -02 & -03 ONLY)

QTE-XXX-XX-XXX-D-XXX

No OF POSITIONS

- 020, -040, -060, \*-080, \*-100 (PER ROW)
- \* = (SEE NOTE 11 & 14)

LEAD STYLE

- 01: .1680 [4.267]
- 02: .2861 [7.267]
- 03: .4042 [10.267]
- 04: .6010 [15.265]
- 05: .7190 [18.263]
- 06: .8370 [21.260]
- 07: .9540 [24.231]
- 08: 1.1510 [29.260]
- 09: .5220 [13.258]
- 10: .5606 [14.239]

PLATING SPECIFICATION

- F: 3 $\mu$ " FLASH GOLD IN CONTACT AREA, MATTE TIN ON TAIL (USE T-1SXX-XX-F, T-1G1-XX-F) (SEE NOTE 07)
- L: 10 $\mu$ " LIGHT GOLD IN CONTACT AREA, MATTE TIN ON TAIL (USE T-1SXX-XX-L, T-1G1-XX-L)
- H: 30 $\mu$ " HEAVY GOLD IN CONTACT AREA, 3 $\mu$ " GOLD ON TAIL (USE T-1SXX-XX-H, T-1G1-XX-G)
- C: 50 $\mu$ " ELECTRO-POLISHED SELECTIVE IN CONTACT AREA, MATTE TIN ON TAIL (USE T-1SXX-XX-C, T-1G1-XX-L)
- STL: 30 $\mu$ " HEAVY SELECTIVE GOLD IN CONTACT AREA, TIN LEAD ON TAIL (USE T-1SXX-XX-STL, T-1G1-XX-STL)
- FTL: 3 $\mu$ " FLASH SELECTIVE GOLD IN CONTACT AREA, TIN LEAD ON TAIL (USE T-1SXX-XX-FTL, T-1G1-XX-FTL)

ROW SPECIFICATION

- D: DOUBLE (USE QTE-20-XX-D-XX & QTEH-20-XX-D-XX)

No OF BANKS

OPTION

- A: ALIGNMENT PINS
- LC: LOCKING CLIPS (SEE NOTE 12) (USE LC-08-TM-01) (SEE FIG 2, SHT 2)
- K: POLYIMIDE FILM (USE K-DOT-.276-.375-.005, SEE FIG 3, SHT 2) (N/A ON STYLE -07 & -08)
- TR: TAPE & REEL (SEE FIG 13, SHT 7) (60 POS. MAX) (40 POS. MAX FOR -GP OPTION) (N/A ON STYLE -05, -06, -07, & -08)
- GP: GUIDE POSTS (SEE FIG 4, SHT 3) (AVAILABLE ON -01 ONLY) (USE QTE-20-01-D-XX-GP) (T & R PACK: 40 POS. MAX.)
- SD: SCREW DOWN (SEE FIG 5, SHT 3) (AVAILABLE ON -01 ONLY) (USE QTE-20-01-D-XX-SD)
- FL: FRICTION LOCKS (SEE FIG 9, SHT 5) (ONLY AVAILABLE ON -01 & -02) (NOT AVAILABLE WITH -GP, -SD)
- RT1: RETENTION OPTION (SEE FIG 11, SHT 6) (ONLY AVAILABLE ON -01 LEAD STYLE) (MUST USE -A OPTION) (USE QTE-20-01-D-XX-A-RT1 & T-1R36-01-F) (NOT AVAILABLE WITH -LC, -GP, -SD, OR -FL)
- L: LATCHING OPTION (40 POS. MAX.) (SEE FIG 12, SHT 6) (MUST USE -A OPTION) (AVAILABLE ON -01 ONLY) (NOT AVAILABLE WITH -LC, -GP, -SD, -FL, OR -RT1)

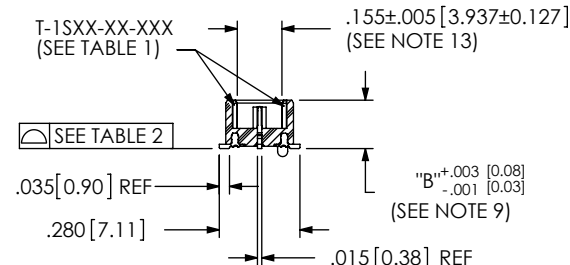
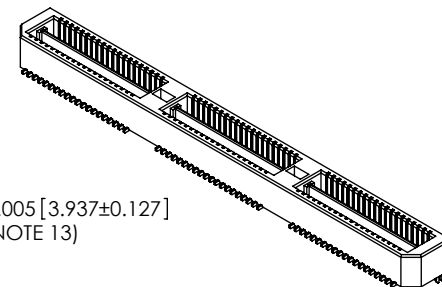

SECTION "A"-"A"

UNLESS OTHERWISE SPECIFIED, DIMENSIONS ARE IN INCHES. TOLERANCES ARE:  
 DECIMALS ANGLES  
 .XX: ±.01 [0.3]  
 .XXX: ±.005 [0.13]  
 .XXXX: ±.0020 [0.051]

PROPRIETARY NOTE  
 THIS DOCUMENT CONTAINS INFORMATION CONFIDENTIAL AND PROPRIETARY TO SAMTEC, INC. AND SHALL NOT BE REPRODUCED OR TRANSFERRED TO OTHER DOCUMENTS OR DISCLOSED TO OTHERS OR USED FOR ANY PURPOSE OTHER THAN THAT WHICH IT WAS OBTAINED WITHOUT THE EXPRESSED WRITTEN CONSENT OF SAMTEC, INC.



520 PARK EAST BLVD, NEW ALBANY, IN 47150  
 PHONE: 812-944-6733 FAX: 812-948-5047  
 e-Mail info@SAMTEC.com code 55322

MATERIAL: DO NOT SCALE DRAWING SHEET SCALE: 1.5:1  
 INSULATOR: LCP, UL94V-0; COLOR: BLACK  
 TERMINAL: PHOS BRONZE  
 GROUND PLANE: PHOS BRONZE

DESCRIPTION: .8mm DOUBLE ROW HS TERMINAL ASSEMBLY

DWG. NO. QTE-XXX-XX-XXX-D-XXX

BY: DEAN P 09-14-2010 SHEET 1 OF 7

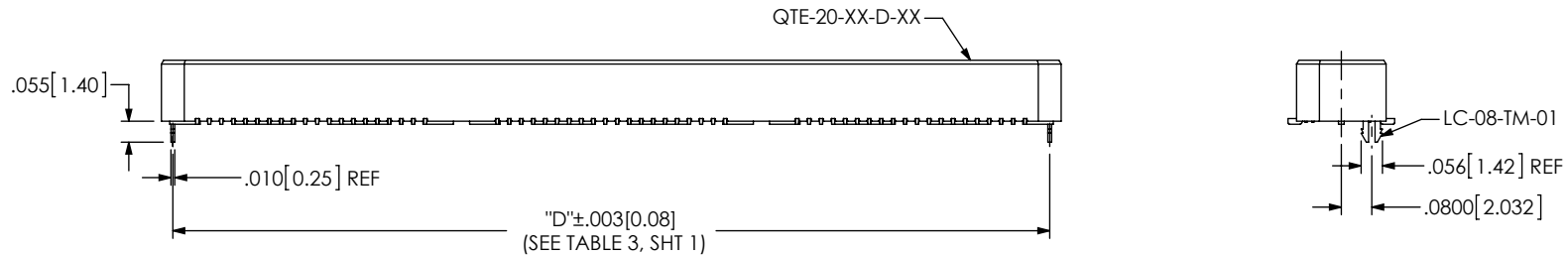

FIG 2  
 -LC: LOCKING CLIP OPTION  
 (QTE-060-01-XXX-D-LC SHOWN)  
 (DIFFERENT AS SHOWN, OTHERWISE SAME AS FIG 1)

No OF POS	"R"				"S"			
	-LC, -A, -FL	-GP, -SD	-RT1	-L	-LC, -A, -FL	-GP, -SD	-RT1	-L
-020	.788 [20.00]	1.305 [33.15]	1.438 [36.53]	.906 [23.00]	.256 [6.50]	.515 [13.07]	.581 [14.76]	.315 [7.99]
-040	1.575 [40.01]	2.093 [53.15]	2.226 [56.53]	1.693 [43.00]	.650 [16.50]	.908 [23.07]	.975 [24.76]	.709 [18.00]
-060	2.363 [60.01]	2.880 [73.15]	3.013 [76.53]	N/A	1.043 [26.50]	1.302 [33.07]	1.369 [34.76]	N/A
*-080	3.150 [80.01]	3.668 [93.15]	3.801 [96.53]	N/A	1.437 [36.50]	1.696 [43.07]	1.762 [44.76]	N/A
*-100	3.938 [100.01]	4.455 [113.16]	N/A	N/A	1.831 [46.50]	2.090 [53.07]	N/A	N/A

\* = (SEE NOTE 11 & 14)

STYLE	"T"
-01	.173[4.39]
-02	.291[7.39]
-03	.409[10.39]
-04	.605[15.37]
-05	.721[18.31]
-06	.840[21.33]
-09	.528 [13.41]
-10	.567[14.37]

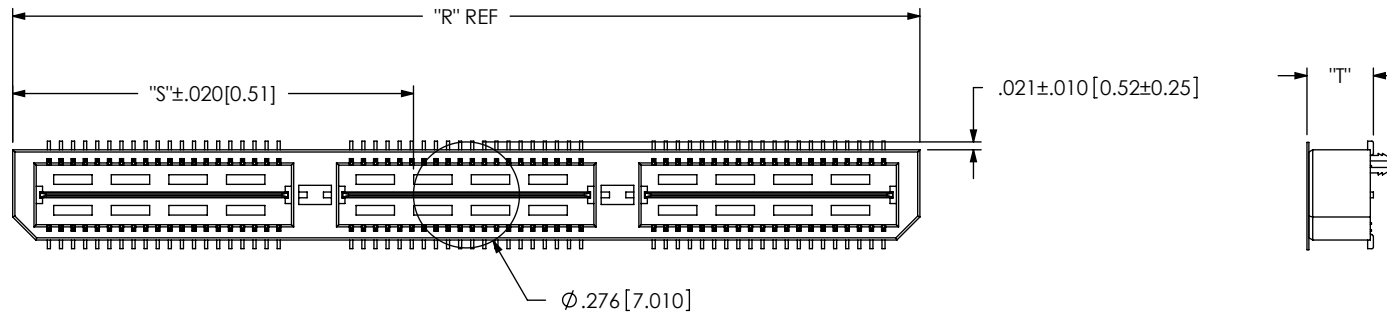

FIG 3  
 -K: POLYIMIDE FILM PAD  
 (USE K-DOT-.276-.375-.005)

PROPRIETARY NOTE  
 THIS DOCUMENT CONTAINS INFORMATION  
 CONFIDENTIAL AND PROPRIETARY TO  
 SAMTEC, INC. AND SHALL NOT BE REPRODUCED  
 OR TRANSFERRED TO OTHER DOCUMENTS OR  
 DISCLOSED TO OTHERS OR USED FOR ANY  
 PURPOSE OTHER THAN THAT WHICH IT WAS  
 OBTAINED WITHOUT THE EXPRESSED WRITTEN  
 CONSENT OF SAMTEC, INC.

DO NOT SCALE DRAWING

SHEET SCALE: 2:1

**samtec**

520 PARK EAST BLVD, NEW ALBANY, IN 47150  
 PHONE: 812-944-6733 FAX: 812-948-5047  
 e-Mail: info@SAMTEC.com code 5332

DESCRIPTION:  
 .8mm DOUBLE ROW HS TERMINAL ASSEMBLY

DWG. NO.  
 QTE-XXX-XX-XXX-D-XXX

BY: DEAN P 09-14-2010 SHEET 2 OF 7

TABLE 6		
POS	"E"	"F"
-020	1.305 [33.15]	1.013 [25.72]
-040	2.093 [53.15]	1.800 [45.72]
-060	2.880 [73.15]	2.588 [65.72]
*-080	3.668 [93.15]	3.375 [85.73]
*-100	4.455 [113.16]	4.163 [105.73]

\* = (SEE NOTE 11 & 14)

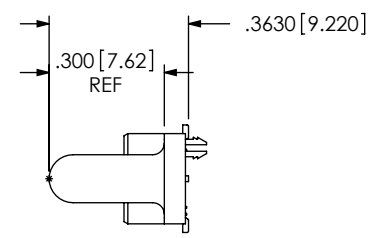
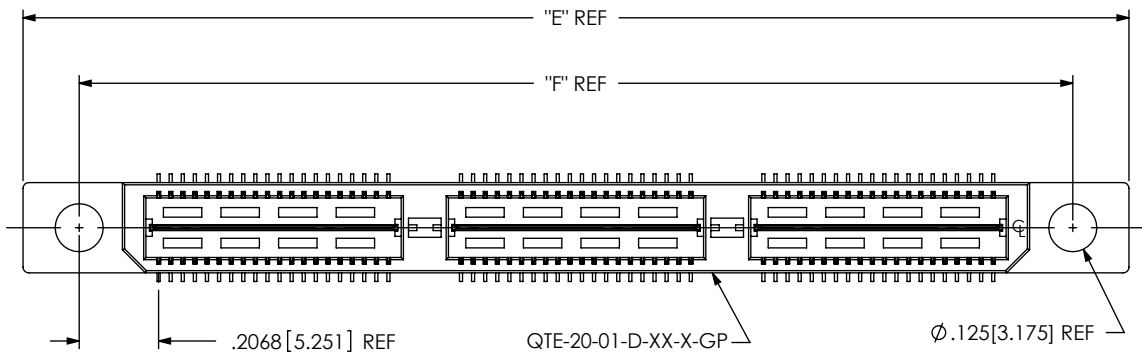

**FIG 4**  
 -GP: GUIDE POST OPTION  
 (QTE-060-01-XXX-D-GP SHOWN)  
 (DIFFERENT AS SHOWN, OTHERWISE SAME AS FIG 1)  
 (AVAILABLE ON STYLE -01 ONLY)

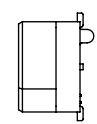
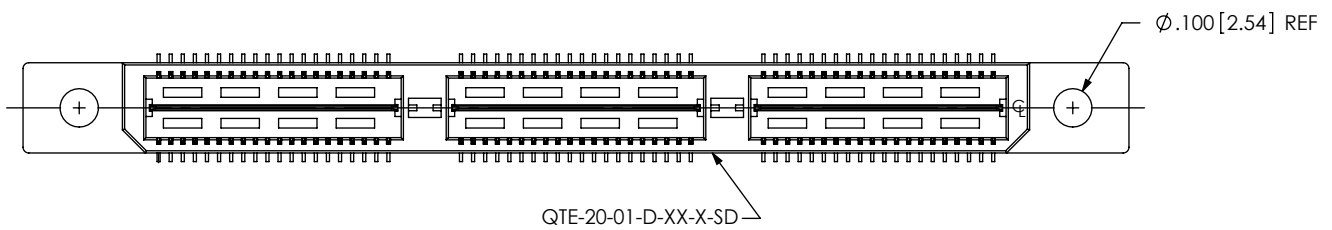

**FIG 5**  
 -SD: SCREW DOWN OPTION  
 (QTE-060-01-XXX-D-A-SD SHOWN)  
 (DIFFERENT AS SHOWN, OTHERWISE SAME AS FIG 4)  
 (AVAILABLE ON STYLE -01 ONLY)

**PROPRIETARY NOTE**  
 THIS DOCUMENT CONTAINS INFORMATION CONFIDENTIAL AND PROPRIETARY TO SAMTEC, INC. AND SHALL NOT BE REPRODUCED OR TRANSFERRED TO OTHER DOCUMENTS OR DISCLOSED TO OTHERS OR USED FOR ANY PURPOSE OTHER THAN THAT WHICH IT WAS OBTAINED WITHOUT THE EXPRESSED WRITTEN CONSENT OF SAMTEC, INC.

DO NOT SCALE DRAWING

SHEET SCALE: 2:1

**samtec**  
 520 PARK EAST BLVD, NEW ALBANY, IN 47150  
 PHONE: 812-944-6733 FAX: 812-948-5047  
 e-Mail: info@SAMTEC.com code 55322

DESCRIPTION:  
 .8mm DOUBLE ROW HS TERMINAL ASSEMBLY

DWG. NO.  
**QTE-XXX-XX-XXX-D-XXX**

BY: DEAN P 09-14-2010 SHEET 3 OF 7

**FIG 6**  
QTE-060-04-X-D-IC SHOWN  
(DIFFERENT AS SHOWN, OTHERWISE SAME AS FIG 1)  
(STYLES -04, -05 & -06)

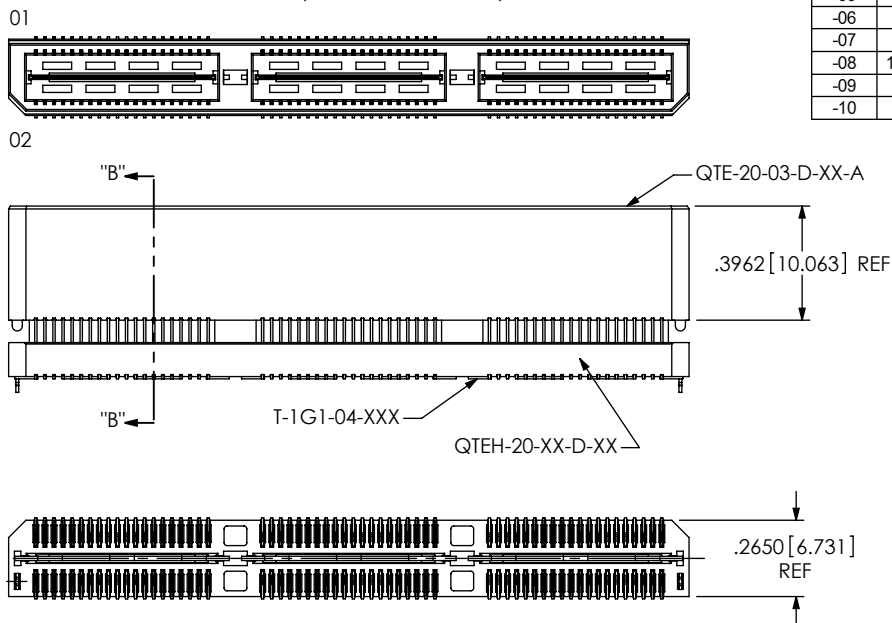
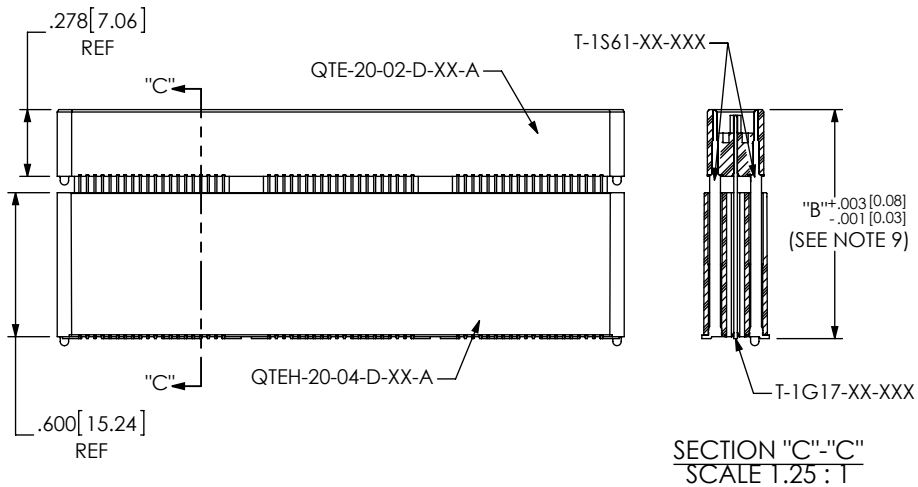
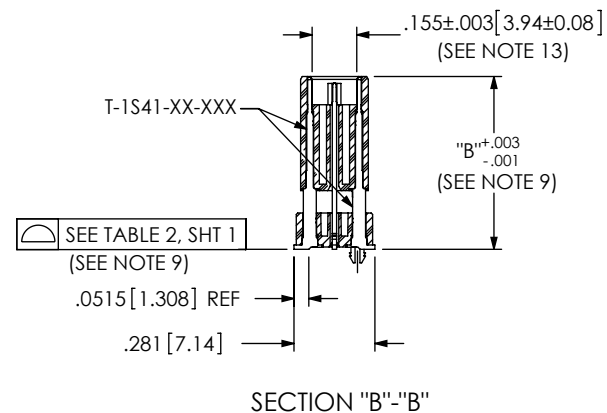
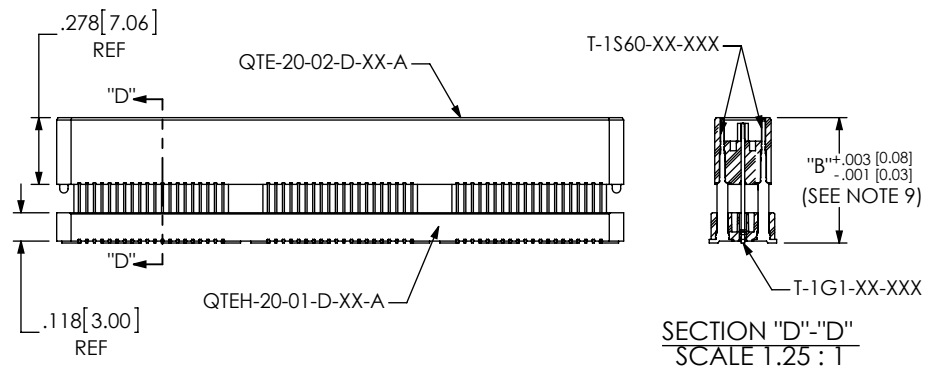

TABLE 7							MATED HEIGHT WITH QSE-01
STYLE	"B"	GROUND PLANE	TERMINAL	BOTTOM SPACER BODY	TOP BODY		
-04	.6010 [15.265]	T-1G1-04-XXX	T-1S41-04-XXX	QTEH-20-01-D-XX-X	QTE-20-03-D-XX-X		.630[16.00] REF
-05	.7190 [18.263]	T-1G1-05-XXX	T-1S41-05-XXX	QTEH-20-01-D-XX-X	QTE-20-03-D-XX-X		.748[19.00] REF
-06	.8370 [21.260]	T-1G1-06-XXX	T-1S41-06-XXX	QTEH-20-02-D-XX-X	QTE-20-03-D-XX-X		.866[22.00] REF
-07	.9540 [24.232]	T-1G17-01-XXX	T-1S61-21-XXX	QTEH-20-04-D-XX-X	QTE-20-02-D-XX-X		.984[25.00] REF
-08	1.1510 [29.235]	T-1G17-02-XXX	T-1S61-22-XXX	QTEH-20-04-D-XX-X	QTE-20-02-D-XX-X		1.181[30.00] REF
-09	.5220 [13.259]	T-1G1-09-XXX	T-1S60-09-XXX	QTEH-20-01-D-XX-X	QTE-20-02-D-XX-X		.551[14.00] REF
-10	.5606 [14.239]	T-1G1-10-XXX	T-1S60-10-XXX	QTEH-20-01-D-XX-X	QTE-20-02-D-XX-X		.591[15.00] REF



**FIG 7**  
QTE-060-07-X-D-A SHOWN  
(DIFFERENT AS SHOWN, OTHERWISE SAME AS FIG 6)  
(STYLES -07 & -08)



**FIG 8**  
QTE-060-09-X-D-A SHOWN  
(DIFFERENT AS SHOWN, OTHERWISE SAME AS FIG 6)  
(STYLES -09 & -10)

F:\DWG\MISC\MKTG\QTE-XXX-XX-XXX-D-XXX-MKT.SLDDRW

PROPRIETARY NOTE  
THIS DOCUMENT CONTAINS INFORMATION  
CONFIDENTIAL AND PROPRIETARY TO  
SAMTEC, INC. AND SHALL NOT BE REPRODUCED  
OR TRANSFERRED TO OTHER DOCUMENTS OR  
DISCLOSED TO OTHERS OR USED FOR ANY  
PURPOSE OTHER THAN THAT WHICH IT WAS  
OBTAINED WITHOUT THE EXPRESSED WRITTEN  
CONSENT OF SAMTEC, INC.

DO NOT SCALE DRAWING

SHEET SCALE: 1.5:1

**samtec**

520 PARK EAST BLVD. NEW ALBANY, IN 47150  
PHONE: 812-944-6733 FAX: 812-948-5047  
e-Mail: info@SAMTEC.com code 55322

DESCRIPTION:  
.8mm DOUBLE ROW HS TERMINAL ASSEMBLY

DWG. NO.  
**QTE-XXX-XX-XXX-D-XXX**

BY: DEAN P 09-14-2010 SHEET 4 OF 7

FIG 9  
 -FL: FRICTION LOCKS  
 (QTE-020-01-XXX-D-A-FL SHOWN)  
 (DIFFERENT AS SHOWN, OTHERWISE SAME AS FIG 1)  
 (ONLY AVAILABLE ON -01 & -02 LEAD STYLES)  
 (NOT AVAILABLE WITH -GP, -SD OPTIONS)

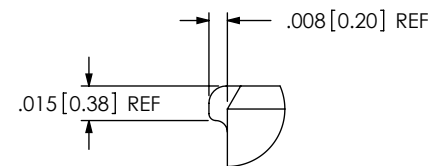
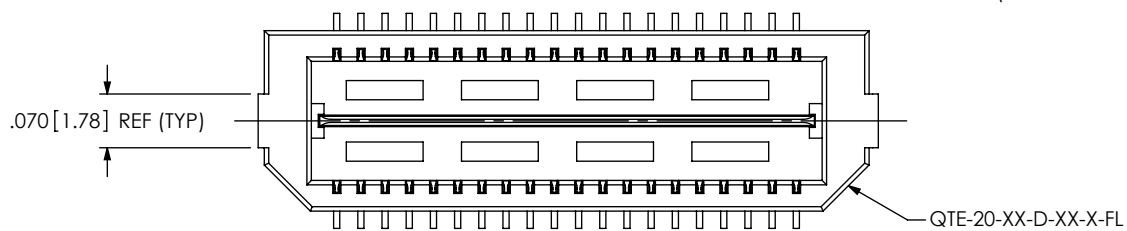

DETAIL 'E'  
 SCALE T2: 1

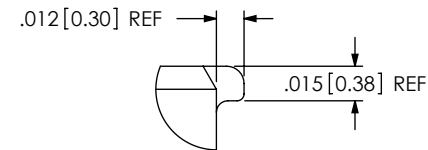
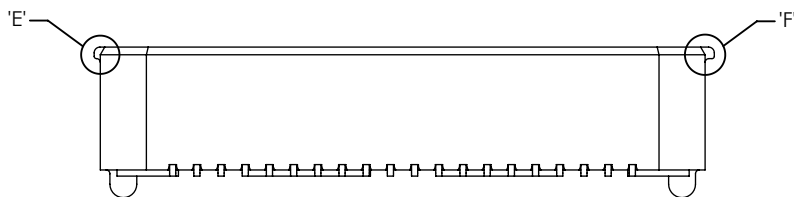

DETAIL 'F'  
 SCALE T2: 1

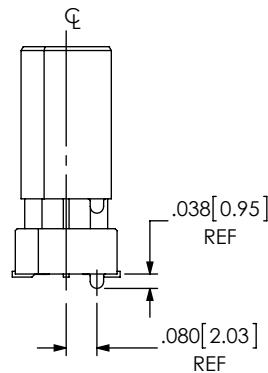
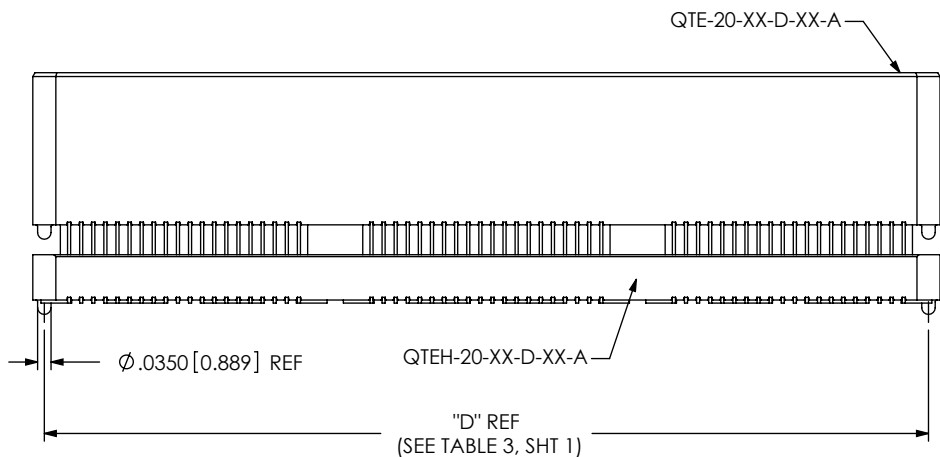

FIG 10  
 (QTE-020-04-XXX-D-A SHOWN)  
 (DIFFERENT AS SHOWN, OTHERWISE SAME AS FIG 1)  
 (STYLES -04, -05, -06, -07, -08, -09 & -10, SEE TABLE 7, SHT 4)

PROPRIETARY NOTE

THIS DOCUMENT CONTAINS INFORMATION CONFIDENTIAL AND PROPRIETARY TO SAMTEC, INC. AND SHALL NOT BE REPRODUCED OR TRANSFERRED TO OTHER DOCUMENTS OR DISCLOSED TO OTHERS OR USED FOR ANY PURPOSE OTHER THAN THAT WHICH IT WAS OBTAINED WITHOUT THE EXPRESSED WRITTEN CONSENT OF SAMTEC, INC.

DO NOT SCALE DRAWING

SHEET SCALE: 2:1



520 PARK EAST BLVD, NEW ALBANY, IN 47150  
 PHONE: 812-944-6733 FAX: 812-948-5047  
 e-Mail: info@SAMTEC.com code 55322

DESCRIPTION:  
 .8mm DOUBLE ROW HS TERMINAL ASSEMBLY

DWG. NO.  
 QTE-XXX-XX-XXX-D-XXX

BY: DEAN P 09-14-2010 SHEET 5 OF 7

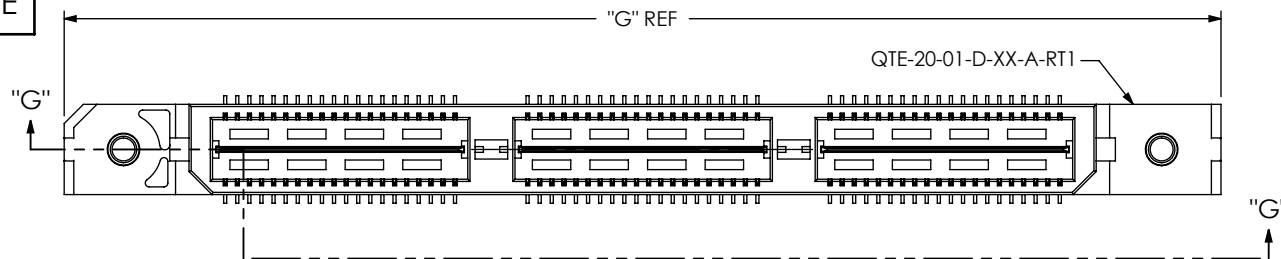

POS	"G"	"H"
-020	1.438 [36.53]	1.129 [28.68]
-040	2.226 [56.53]	1.917 [48.68]
-060	3.013 [76.53]	2.704 [68.68]
*-080	3.801 [96.53]	3.492 [88.68]
*-100	N/A	N/A

\* = (SEE NOTE 11 & 14)

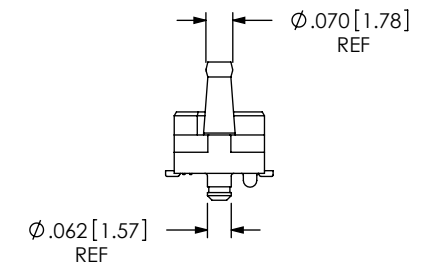
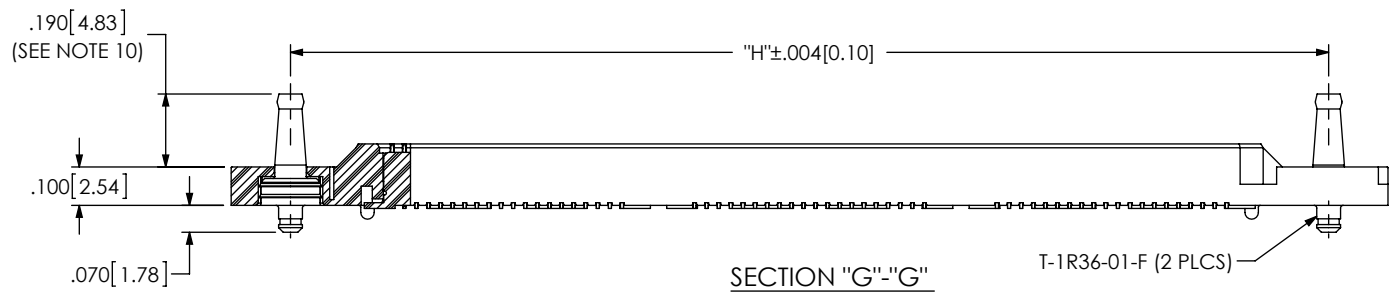
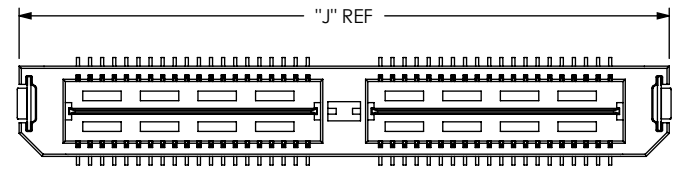

FIG 11  
-RT1: RETENTION OPTION  
(QTE-060-01-XXX-D-A-RT1 SHOWN)  
(DIFFERENT AS SHOWN, OTHERWISE SAME AS FIG 1)  
(ONLY AVAILABLE ON -01 LEAD STYLE) (MUST USE -A OPTION)  
(NOT AVAILABLE WITH -LC, -GP, -SD, OR -FL OPTIONS)  
(NOT AVAILABLE ON -100 POSITION)



POS	"J"	"K"	"L"
-020	.906 [23.00]	.915 [23.24]	.854 [21.69]
-040	1.693 [43.00]	1.703 [43.24]	1.642 [41.69]
-060	N/A	N/A	N/A
*-080	N/A	N/A	N/A
*-100	N/A	N/A	N/A

\* = (SEE NOTE 11 & 14)

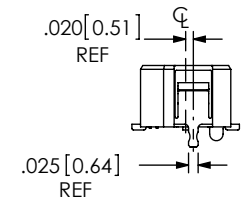
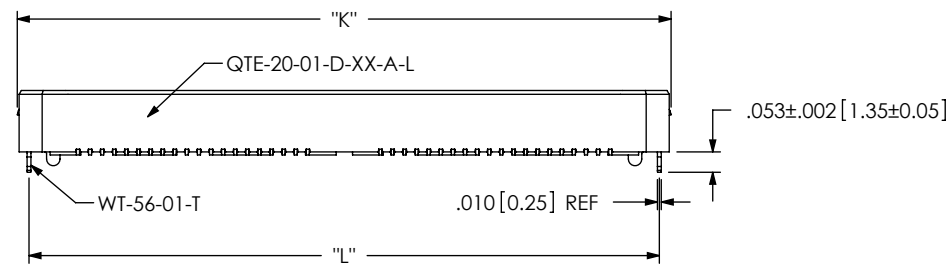

FIG 12  
-L: LATCHING OPTION  
(QTE-040-01-XXX-D-A-L SHOWN)  
(DIFFERENT AS SHOWN, OTHERWISE SAME AS FIG 1)  
(40 POS. MAX.) (MUST USE -A OPTION)  
(AVAILABLE ON -01 LEAD STYLE ONLY)  
(NOT AVAILABLE WITH -LC, -GP, -SD, -FL, OR -RT1)

PROPRIETARY NOTE  
THIS DOCUMENT CONTAINS INFORMATION  
CONFIDENTIAL AND PROPRIETARY TO  
SAMTEC, INC. AND SHALL NOT BE REPRODUCED  
OR TRANSFERRED TO OTHER DOCUMENTS OR  
DISCLOSED TO OTHERS OR USED FOR ANY  
PURPOSE OTHER THAN THAT WHICH IT WAS  
OBTAINED WITHOUT THE EXPRESSED WRITTEN  
CONSENT OF SAMTEC, INC.

DO NOT SCALE DRAWING

SHEET SCALE: 2:1

520 PARK EAST BLVD, NEW ALBANY, IN 47150  
PHONE: 812-944-6733 FAX: 812-948-5047  
e-Mail: info@SAMTEC.com code 55322

DESCRIPTION:  
.8mm DOUBLE ROW HS TERMINAL ASSEMBLY  
DWG. NO. QTE-XXX-XX-XXX-D-XXX

BY: DEAN P 09-14-2010 SHEET 6 OF 7

FIG 13  
 -TR: PACKAGING OPTION  
 (QTE-060-01-XXX-D-LC-TR SHOWN)  
 (DIFFERENT AS SHOWN, OTHERWISE SAME AS FIG 1)  
 (60 POS MAX)  
 (40 POS MAX WITH -GP OPTION)  
 (NOT AVAILABLE ON LEAD SYTTLES -05, -06, -07 & -08)

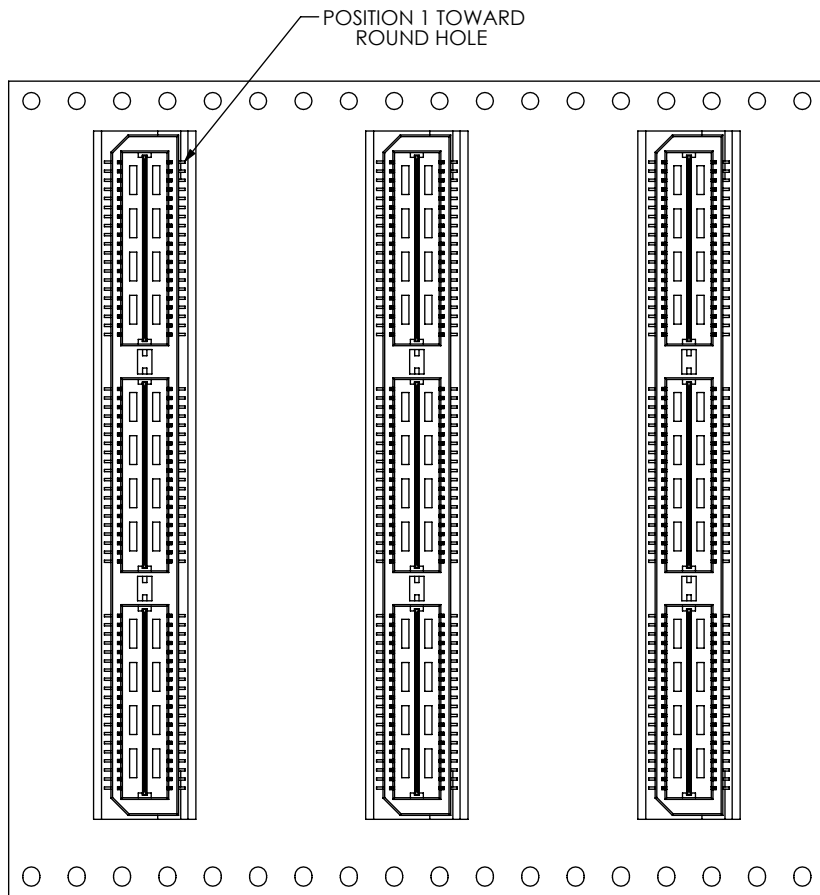

USER DIRECTION OF UN-REELING →  
 POCKET NOT DETAILED

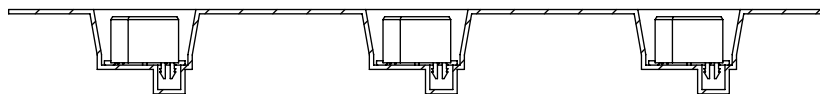

CRITICAL DIMENSION INSPECTION INSTRUCTION TABLE	
ASSEMBLY OPERATION	IN PROCESS INSPECTION
FILL T-1SXX	C1, C2, C3, C4, C5, C13
ADD -LC OPTION	C14
ADD -RT1 OPTION	C6, C8
ADD -L OPTION	C9, C10, C11
ADD -K OPTION	C16, C15
CPC'S INTENTIONALLY DELETED: C7, C12	

**PROPRIETARY NOTE**  
 THIS DOCUMENT CONTAINS INFORMATION  
 CONFIDENTIAL AND PROPRIETARY TO  
 SAMTEC, INC. AND SHALL NOT BE REPRODUCED  
 OR TRANSFERRED TO OTHER DOCUMENTS OR  
 DISCLOSED TO OTHERS OR USED FOR ANY  
 PURPOSE OTHER THAN THAT WHICH IT WAS  
 OBTAINED WITHOUT THE EXPRESSED WRITTEN  
 CONSENT OF SAMTEC, INC.

DO NOT SCALE DRAWING

SHEET SCALE: 1:0.8



520 PARK EAST BLVD, NEW ALBANY, IN 47150  
 PHONE: 812-944-6733 FAX: 812-948-5047  
 e-Mail info@SAMTEC.com code 55322

DESCRIPTION:  
 .8mm DOUBLE ROW HS TERMINAL ASSEMBLY

DWG. NO. QTE-XXX-XX-XXX-D-XXX

BY: DEAN P 09-14-2010 SHEET 7 OF 7

## X-ON Electronics

Largest Supplier of Electrical and Electronic Components

*Click to view similar products for [Board to Board & Mezzanine Connectors](#) category:*

*Click to view products by [Samtec](#) manufacturer:*

Other Similar products are found below :

[10135583-642402LF](#) [89885-310LF](#) [589158040000018](#) [6-1393048-0](#) [68683-613](#) [MDF7-12DP-2.54DSA](#) [MDF7-18P-2.54DSA\(01\)](#) [MDF7-20DP-2.54DSA](#) [MDF7-26D-2.54DSA\(55\)](#) [MDF7-3P-2.54DSA\(01\)](#) [MDF7B-3P-2.54DSA\(55\)](#) [MDF7C-11P-2.54DSA\(55\)](#) [MDF7C-18P-2.54DSA\(55\)](#) [MDF7C-5P-2.54DSA\(01\)](#) [MDF7P-5P-2.54DSA\(55\)](#) [75234-0516](#) [FCN-230C068-11](#) [FCN-268F012-G/BD](#) [FCN-268F036-G/BD](#) [FCN-268M012-G/0D](#) [FCN-268M024-G/1D](#) [FCN-360C008-C](#) [FCN-360C040-C](#) [FCN-723J004/1](#) [MIS-048-01-F-D-DP-K](#) [832-10-034-10-001000](#) [93696-325LF](#) [11828-1FA](#) [AXK630345P](#) [18097-0013](#) [ICA-328STT](#) [2007042-2](#) [304400-2](#) [FCN-214Q030-G/0](#) [FCN-215Q040-G/0](#) [FCN-230C068-ESA](#) [FCN-234P048-G/0](#) [FCN-235D050-G/C](#) [FCN-360A3](#) [FCN-360C040-B](#) [210-93-314-41-105000](#) [2-22603-0](#) [379-064-521-202](#) [MDF7-12P-2.54DSA\(01\)](#) [MDF7-16P-2.54DS\(56\)](#) [MDF7-40DP-2.54DSA\(55\)](#) [MDF7-8P-2.54DSA\(55\)](#) [MDF7B-16P-2.54DSA\(55\)](#) [AXG720047](#) [5031084030](#)