

# Thermoelectric Modules

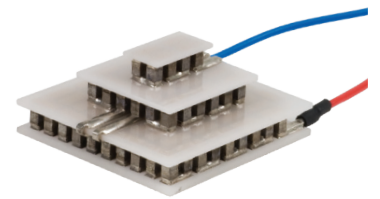

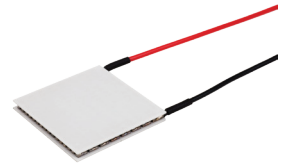

## About Laird

Laird is a global technology company focused on providing systems, components and solutions that protect electronics from electromagnetic interference and heat, and that enable connectivity in mission-critical wireless applications and antenna systems.

We are a global leader in the field of radio frequency (RF) engineering and in the design, development and supply of innovative technology that allows people, organisations and applications to connect efficiently.

Our aim is to be a trusted partner to our customers by delivering problem-solving solutions through Innovation, Reliable Fulfilment, and Speed.

Laird partners with its customers to design custom thermal solutions for applications in many industries including:

- Medical Diagnostics
- Medical Imaging
- Battery Cooling
- Industrial Laser Systems
- Optoelectronics
- Analytical Instrumentation
- Semiconductor Fabrication
- Aerospace Defense
- Food & Beverage
- Automotive



As an industry leader in high-performance Engineered Thermal Systems that demand high system uptime, Laird provides the knowledge, innovation, and resources to ensure exceptional thermal performance and customer satisfaction for applications in the medical, analytical, telecom, industrial, and consumer markets.

## A Brief Introduction to Thermoelectrics

Solid state heat pumps have been in existence since the discovery of the Peltier effect in 1834. The devices became commercially available several decades ago with the development of advanced semiconductor thermocouple materials in combination with ceramic substrates. Thermoelectric modules (TEMs) are solid-state heat pumps that require a heat exchanger to dissipate heat utilizing the Peltier Effect. During operation, DC current flows through the TEM to create heat transfer and a temperature differential across the ceramic substrates, causing one side of the TEM to be cold, while the other side is hot. A standard single-stage TEM can achieve temperature differentials of up to 70°C.

A typical TEM's geometric footprint can vary from 2 x 2 mm's to 62 x 62 mm's and are light in weight. This makes thermoelectrics ideal for applications with tight geometric space constraints and low weight requirements when compared too much larger cooling technologies, such as conventional compressor-based systems. TEMs can also be used as a power generator to convert waste heat into usable output DC power.

Thermoelectrics are ideal for applications that require active cooling to below ambient and have cooling capacity requirements < 600 Watts. A design engineer should consider TEMs when the system design criteria includes such factors as precise temperature control, high reliability, compact geometry constraints, low weight and environmental friendly requirements.

## Benefits of Using Thermoelectrics

TEMs have several advantages over alternate cooling technologies:

- They have no moving parts, so the solid state construction results in high reliability and units can be mounted in any orientation.
- TEMs can cool devices down to well below ambient. Colder temperatures can be achieved, down to minus 100°C, by using a multistage thermoelectric module in a vacuum environment.
- Thermoelectrics are able to heat and cool by simply reversing the polarity, which changes the direction of heat transfer. This allows temperature control to be very precise, where up to  $\pm 0.01^\circ\text{C}$  can be maintained under steady-state conditions.
- In heating mode, TEMs are much more efficient than conventional resistant heaters because they generate heat from input power supplied plus additional heat generated by the heat pumping action.
- Devices are environmentally friendly because they use no CFC's and electrical noise is minimal.
- TEMs can be used as energy harvesters, turning waste heat into usable output DC power.

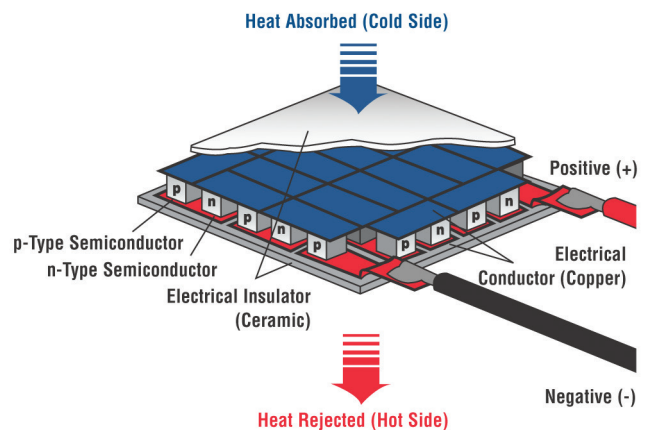

# Thermoelectric Product Line

Laird designs and manufactures thermoelectric modules (TEMs) which adhere to strict process control standards and pass/fail criteria, assuring our customers receive the best possible modules. Our extensive standard product portfolio covers a wide range of cooling capacities, temperature differentials, input power requirements and geometric footprints. Standard finishing options are available to accommodate alternate lead lengths, lapping thickness tolerances, and moisture protective sealants. Standard pre-tinning and solder constructions are available to accommodate solder-able mounting of the TEM to the heat exchanger, or processing of TEM through a reflow oven to solder onto an optoelectronic package.

Laird offers several thermoelectric module product families that can be classified by cooling capacity, temperature differential, form factor or thermal cycling capability. Reference perceptual map as a general guide as to where each product family fits with regards to these attributes.

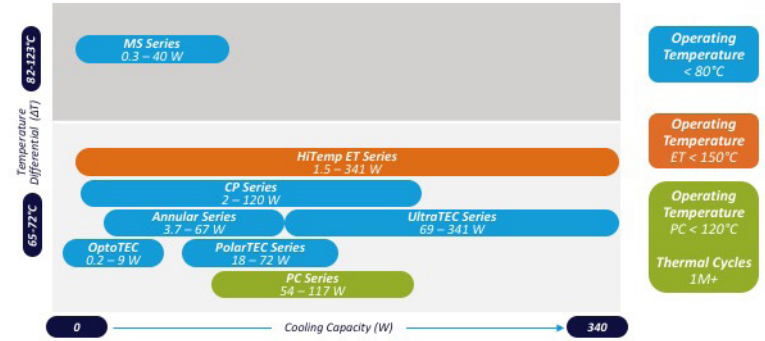

## Telecommunications

Optical components are used in backhaul communications to transmit data. Temperature stabilization of these devices is required to maintain peak performance while ambient environment conditions fluctuate over time. Compact form factors are required to keep package size down as well as no outgassing of thermal component.

- Laser Diodes
- Photodiodes
- Telecom Enclosures
- Pump Lasers
- Optical Transceivers

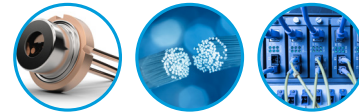

## Medical

Reagents are used in medical diagnostics to help analyze liquid samples obtained from patients to diagnose an illness. TEMs refrigerate the reagents to extend their life and keep costs down. Molecular diagnostics use TEMs to thermal cycle DNA samples to create millions of strands of DNA for analysis. Medical lasers use TEMs to keep temperature of laser stable and for patient comfort during treatment.

- Medical Imaging
- Medical Lasers
- Molecular Diagnostics
- Medical Diagnostics
- Analytical Instrumentation



## Industrial & Instrumentation

Operating IR detectors and CCD's at low temperatures limits the noise they are exposed too. This expands the light spectrum they are able to capture and increase resolution. Industrial lasers and metrology instrumentation use TEMs for temperature stabilization to maintain peak performance. Digital printers use TEMs to control the humidity and optimize the ink drying process in high volume production runs.

- CCD Cameras
- Kiosks
- Digital Color Printing
- Thermal Imaging
- Metrology Instrumentation
- Industrial Laser Systems



## Transportation

Advancements in transportation technology require continued innovations in thermal management solutions. For example, use of smart lighting headlamps or industrial x-ray inspection systems, provide numerous benefits, however at increased temperatures that the devices must endure. Active cooling mechanisms that feature the use of TEMs provide the thermal management solutions needed to operate each device within an acceptable temperature range that optimizes its performance.

- Smart Lighting
- Heads-Up Displays
- Imaging Sensors



# TEM Rapid Prototyping Center

Since there are so many unique attributes that need to be ascertained for each application, often a customized TEM will yield a more optimal thermal solution. Laird offers strong engineering services with a global presence that supports onsite concept generation, thermal modeling, thermal design and rapid prototyping. We also offer validation test services to meet unique compliance standards for each industry, such as Telcordia, MIL-STDs or standards specific to unique application. Minimum order quantity (MOQ) applies for all custom TEM designs and validation testing.

## Custom Thermoelectric Modules

- Patterning and Plating on Substrates
- TE semiconductor Processing
- Lapping, Wiring and Sealing
- Test Validation
- Tooling Fabrication
- TEM Assembly

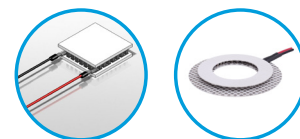

# OptoTEC™

- Miniature Form Factor
- Pb-free solder construction with melt temperature of 138°C
- Alumina or Aluminum Nitride Substrates Available
- Designed for laser diodes, infrared detectors, pump lasers and optical transceivers

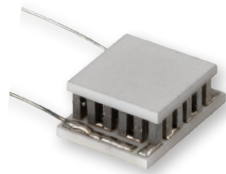

PART NO.	QMAX <sup>(1)</sup> (WATTS)	IMAX (AMPS)	VMAX (VOLTS)	ΔTMAX (°C)	DIM A (mm)	DIM B (mm)	DIM C (mm)	DIM D <sup>(2)</sup> (mm)	DIM E (mm)
OT08,04,F0,0203,11,W2.25	0.22	0.8	0.5	67	1.8	3.4	3.4	2.4	-
OT08,08,F0,0305,11,W2.25	0.44	0.8	0.9	67	3.3	3.3	4.9	2.4	-
OT08,11,F1,0305,11,W2.25	0.6	0.8	1.33	67	3.4	5	3.4	2.4	-
OT08,18,F0,0505,11,W2.25	0.97	0.8	2.2	67	4.9	4.9	6.6	2.4	-
OT08,18,F2,0505,11,W2.25	0.97	0.8	2.2	67	5	5	6.7	2.4	-
OT08,32,F2,0707,11,W2.25	1.72	0.8	3.9	67	6.6	6.6	8.3	2.4	-
OT08,66,F0,1009,11,W2.25	3.6	0.8	7.9	67	9.8	8.9	11.4	2.4	-
OT12,12,F0,0406,11,W2.25	0.97	1.2	1.5	67	4.2	6.2	6.2	2.7	-
OT12,18,F0,0606,11,W2.25	1.46	1.2	2.1	67	6.2	6.2	8.3	2.7	-
OT12,18,F2A,0606,11,W2.25	1.46	1.2	2.1	67	6	6.2	7.2	2.7	-
OT12,62,F3,1211,11,W2.25	5.01	1.2	7.5	67	12.2	11.2	13.2	2.7	2.0
OT12,66,F0,1211,11,W2.25	5.3	1.2	8	67	12.3	11.3	14.4	2.7	-
OT15,30,F2A,0610,11,W2.25	3.03	1.5	3.6	67	6.2	10.3	12.3	2.1	-
OT15,66,F0,1211,11,W2.25	6.7	1.5	8	67	12.3	11.3	14.4	2.4	-
OT15,68,F1A,1313,11,W2.25	6.87	1.5	8.2	67	13.2	13.2	13.2	2.4	-
OT16,18,F2,0606,11,W2.25	2	1.6	2	67	6	7.6	6	2	-
OT20,12,F0,0406,11,W2.25	1.62	2	1.5	67	4.2	6.2	6.2	2.2	-
OT20,31,F1,0808,11,W2.25	4.2	2	3.7	67	8.1	8.1	8.1	2.2	-
OT20,32,F0,0808,11,W2.25	4.4	2	3.6	67	8.3	8.3	10.3	2.2	-
OT20,66,F0,1211,11,W2.25	8.8	2	7.8	67	12.1	11.1	14.2	2.5	-
OT24,31,F1,1010,TA,W2.25	5.3	2.5	3.5	65	10	10	10	2.5	-
OT20,30,F2A,0610,11,W2.25	4	2	3.6	67	6.2	10.3	12.3	1.8	-

Notes: 1) QMax rated value at ΔT = 0°C, Imax and Vmax, Th = 25°C; 2) Thickness for non-metallized versions only. All modules are lead-free. For wiring options contact Laird.

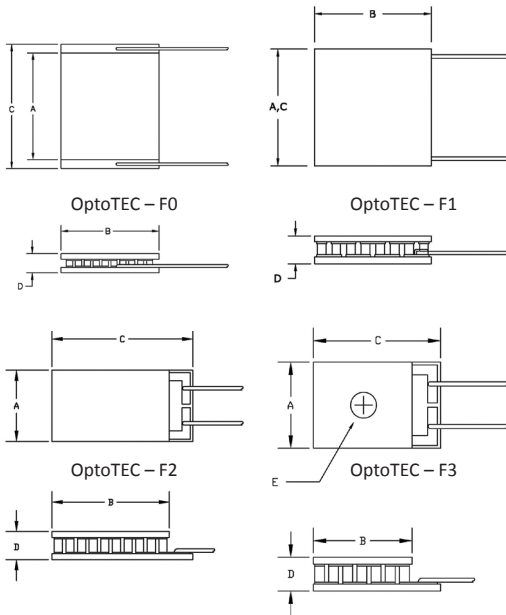

# PC Series

- Designed for thermal cycling between multiple temperature set points
- Ideal for applications in molecular diagnostics a large number of thermal cycles are required
- Specially constructed to reduce the amount of stress induced on the TE elements during operation
- Tested to withstand more than 1M cycles without degradation in performance



Typical TEM Module

PART NO.	QMAX (WATTS)	IMAX (AMPS)	VMAX (VOLTS)	ΔTMAX (°C)	DIM A (mm)	DIM B (mm)	DIM C (mm)	DIM D (mm)	DIM E (mm)	Wire (AWG)
PC4,12,F1,3030,TA,W6	33.4	3.9	14.4	67	30	30	30	3.2	-	20
PC5,16,F1,4040,TA,W6	53.2	4.8	18.3	67	40	40	40	3.7	20	20
PC7,16,F1,4040,TA,W6	76.3	7	18.3	67	40	40	40	3.3	20	20
PC6,12,F1,4040,TA,W6	54.1	6.1	14.9	67	40	40	40	3.0	20	20
PC8,12,F1,4040,TA,W6	72	8.5	14.5	67	40	40	40	3.3	20	20
PC12,139,F1,3550,TA,W6	117	12.3	15.5	67	35	50	35	3.0	20	20

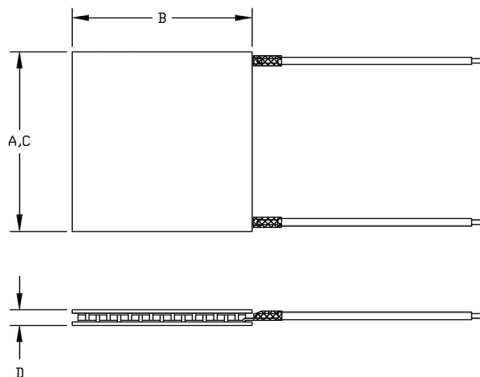

# CP Series

- Designed for high current, large heat pumping applications
- Wide product breadth that covers many form factors, input power requirements and heat pumping capacities
- Ideal for medical diagnostics, analytical instrumentation, photonics laser systems and battery cooling

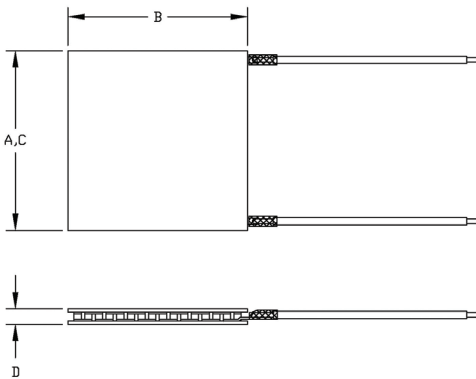
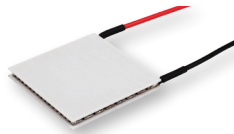

PART NO.	QMAX <sup>(1)</sup> (WATTS)	IMAX (AMPS)	VMAX (VOLTS)	ΔTMAX (°C)	DIM A (mm)	DIM B (mm)	DIM C (mm)	DIM D (mm)	Wire (AWG)
CP08,127,05,L1,W4.5	22.4	2.6	15.4	67	25	25	25	3.1	26
CP08,127,06,L1,W4.5	18.1	2.1	15.4	67	25	25	25	3.4	26
CP08,31,06,L1,W4.5	4.4	2.1	3.8	67	12	12	12	3.4	26
CP08,63,06,L1,W4.5	9	2.1	7.6	67	12	25	12	3.4	26
CP08,71,06,L,W4.5	10.1	2.1	8.6	67	18	18	18	3.4	26
CP085,127,06,L1,W4.5	20.2	2.7	15.3	66	30	30	30	3.6	26
CP10,127,05,L1,W4.5	33.4	3.9	15.4	67	30	30	30	3.2	24
CP10,127,06,L1,W4.5	25.7	3	15.4	67	30	30	30	3.6	24
CP10,127,08,L1,W4.5	21.4	2.5	15.4	67	30	30	30	4	24
CP10,131,04,L1,W4.5	54.1	6.1	14.9	67	40	23	40	3	24
CP10,254,06,L1,W4.5	51.4	3.0/6.0	30.8/15.4	67	60	30	30	3.6	24
CP10,31,05,L1,W4.5	8.2	3.9	3.8	67	15	15	15	3.2	24
CP10,31,06,L,W4.5	6.3	3	3.75	67	15	15	15	3.6	24
CP10,31,08,L1,W4.5	5.3	2.5	3.8	67	15	15	15	4	24
CP10,63,05,L1,W4.5	16.6	3.9	7.6	67	15	30	15	3.2	24
CP10,63,06,L1,W4.5	12.7	3	7.6	67	15	30	15	3.6	24
CP10,71,05,L,W4.4	18.7	3.9	8.6	67	23	23	23	3.2	24
CP10,71,06,L,W4.5	14.4	3	8.6	67	23	23	23	3.6	24
CP12,161,04,L1,W4.5	69.3	6.4	18.3	67	40	40	40	3.3	22
CP12,161,06,L1,W4.5	52.2	4.8	18.3	67	40	40	40	3.6	22
CP14,127,045,L1,W4.5	72	8.5	15.4	65	40	40	40	3.3	18
CP14,127,06,L1,W4.5	51.4	6	15.4	67	40	40	40	3.8	18
CP14,127,10,L1,W4.5	33.4	3.9	15.4	68	40	40	40	4.7	18
CP14,17,06,L,W4.5	6.9	6	2.06	67	15	15	15	3.8	18
CP14,17,10,L,W4.5	4.5	3.9	2.06	68	15	15	15	4.7	18
CP14,199,045,L1,W4.5	115.7	8.5	22.4	65	40	40	40	3.3	18
CP14,199,06,L1,W4.5	80.9	6	22.7	67	40	40	40	3.81	18
CP14,31,045,L,W4.5	20.4	8.7	4.0	68	15	30	15	3.32	18
CP14,31,10,L1,W4.5	8.2	3.9	3.75	68	20	20	20	4.7	18
CP14,35,045,L1,W4.5	19	8.5	4.2	65	15	30	15	3.3	18
CP14,63,045,L,W4.4	36.6	8.5	7.1	65	20	40	20	3.31	18
CP14,63,06,L,W4.5	25.4	6	7.1	67	20	40	20	3.81	18
CP14,63,10,L,W4.5	16.6	3.9	7.1	67	20	40	20	4.7	18
CP14,71,045,L1,W4.5	38.5	8.5	8.6	65	30	30	30	3.3	18
CP14,71,06,L1,W4.5	28.7	6	8.6	67	30	30	30	3.8	18
CP14,71,10,L1,W4.5	18.7	3.9	8.6	68	30	30	30	4.7	18
CP2,127,06,L1,W4.5	120	14	15.4	67	62	62	62	4.6	18
CP2,127,10,L1,W4.5	77.1	9	15.4	68	62	62	62	5.6	18
CP2,31,06,L1,W4.5	29.3	14	3.8	67	30	30	30	4.6	18
CP2,31,10,L1,W4.5	18.8	9	3.8	68	30	30	30	5.6	18
CP2,71,06,L1,W4.5	67	14	8.6	68	44	44	44	4.6	18

# Annular Series

- Features center hole for transmission of light, wires, probes or mounting hardware
- Round or square hole configurations available
- Rapid prototyping available to accommodate unique shape requirements

PART NO.	QMAX <sup>(1)</sup> (WATTS)	IMAX (AMPS)	VMAX (VOLTS)	ΔTMAX (°C)	DIM A (mm)	DIM B (mm)	DIM C (mm)	DIM D (mm)	DIM E (mm)
RH14,14,045,L,W4.4	7.6	8.5	1.7	65	26	26	26	3.3	14
RH14,14,10,L,W4.5	3.7	3.9	1.7	68	26	26	26	4.7	14
RH14,14,06,L1,W4.5	5.7	6	1.7	67	26	26	26	3.8	14
RH14,32,06,L1,W4.5	12.9	6	3.9	67	44	55	55	3.8	27
SH10,23,06,L1,W4.5	4.7	3	2.8	67	15	15	15	3.6	7.2
SH08,28,05,L1,W4.5	4.9	2.6	3.9	67	14.7	10.3	14.7	3.1	4.4
SH10,125,05,L1,W4.5	32.9	3.9	15.2	67	30	30	30	3.2	3.6
SH14,125,10,L1,W4.5	32.9	3.9	15.2	68	40	40	40	4.7	4.7
SH14,125,06,L1,W4.5	50.7	6	15.2	67	40	40	40	3.8	4.7
SH14,125,045,L1,W4.5	67.7	8.5	15.2	65	40	40	40	3.3	4.7

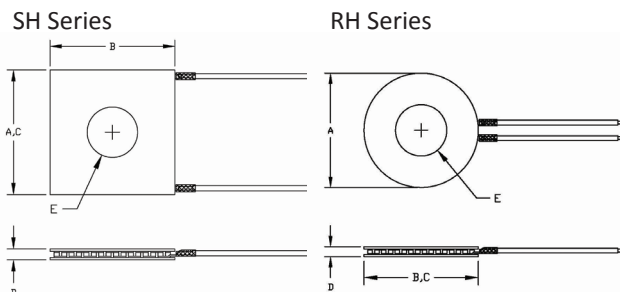

Notes: 1) QMax rated value at ΔT = 0°C, Imax and Vmax, Th = 25°C; 2) Thickness for non-metallized versions only. All modules are lead-free. For wiring options contact Laird.



## PolarTEC™

- Porch style ceramic for improved lead attachment
- Standard 4,6 and 8 Amp configurations available
- Designed for high volume production runs in consumer, food and beverage markets

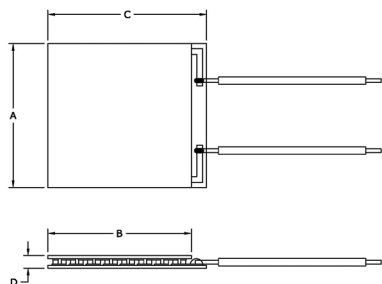

PART NO.	QMAX <sup>(1)</sup> (WATTS)	IMAX (AMPS)	VMAX (VOLTS)	ΔTMAX (°C)	DIM A (mm)	DIM B (mm)	DIM C (mm)	DIM D (mm)	Wire (AWG)
P4,7,F2,3030,TA,W5	18	3.7	8.1	67	30	30	34	4.1	18
PT6,7,F2,3030,TA,W6	29	6	8.1	65	30	30	34	3.8	18
PT4,12,F2,3030,TA,W6	33	3.9	14.4	65	30	30	34	3.2	24
PT4,12,F2,4040,TA,W6	32	3.7	14.4	67	40	40	44	4.1	18
PT6,12,F2,4040,TA,W6	52	6	14.4	65	40	40	44	3.8	18
PT8,12,F2,4040,TA,W6	72	8.5	14.4	64	40	40	44	3.3	18

## UltraTEC™

- High heat flux density, up to 12.5W/cm<sup>2</sup>
- High COP in low power input applications
- Ideal for laser systems in the industrial and medical markets and high powered projectors

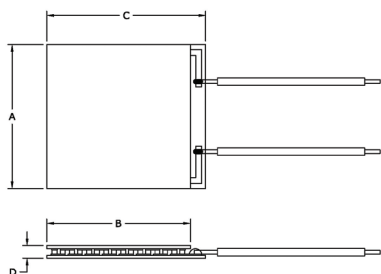
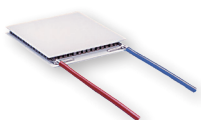

PART NO.	QMAX <sup>(1)</sup> (WATTS)	IMAX (AMPS)	VMAX (VOLTS)	ΔTMAX (°C)	DIM A (mm)	DIM B (mm)	DIM C (mm)	DIM D (mm)	Wire (AWG)
UT11,12,F2,3030,TA,W6	95	11	14.4	69	30	30	34	2.4	22
UT15,12,F2,4040,TA,W6	126	14.6	14.4	69	40	40	44	2.8	20
UT8,12,F2,3030,TA,W6	69	7.9	14.4	69	30	30	34	2.6	20
UT15,200,F2,4040,TA,W6	236	15.4	25	68	40	40	44	3.3	20
UT15,24,F2,5252,TA,W6	288	15.1	30.8	70	52	52	56	3.3	20
UT15,288,F2,5252,TA,W7	341	15.4	36	68	52	52	56	3.3	20
UT6,19,F1,4040,TA,W9	93	6	24.6	70	40	40	40	3.9	20
UT6,24,F1,5555,TA,W9	113	6	29.8	70	55	55	55	3.9	20
UT8,12,F2,2525,TA,W7	69	7.9	14.4	69	25	25	25	1.9	20
UT8,200,F2,4040,TA,W7	128	8.5	24.9	70	40	40	44	3.8	20
UT8,24,F1,5555,TA,W9	153	8.5	29.8	70	55	55	55	3.8	20
UT8,288,F2,5252,TA,W7	182	8.5	35.9	70	52	52	56	3.8	20
UT9,28,F2,4040,TA,W9	206	9.2	36.7	68	40	40	44	2.8	20

## ZT Series

- Assembled with premium Bismuth Telluride semiconductor material
- Achieves a higher temperature differential than standard single stage TEMs
- Ideal for applications that require to reach colder temperatures

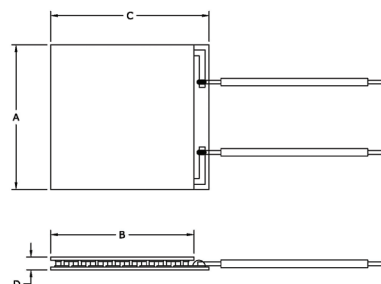
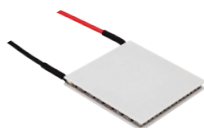

PART NO.	QMAX <sup>(1)</sup> (WATTS)	IMAX (AMPS)	VMAX (VOLTS)	ΔTMAX (°C)	DIM A (mm)	DIM B (mm)	DIM C (mm)	DIM D (mm)	Wire (AWG)
ZT4,7,F1,2020,TA,W8	18	3.9	8.8	74	20	20	20	3.6	22
ZT6,7,F1,3030,TA,W8	31	6.0	8.6	74	30	30	30	3.9	22
ZT4,12,F1,3030,TA,W8	35	3.9	16.4	74	30	30	30	3.6	22
ZT4,12,F1,4040,TA,W8	37	3.9	15.4	74	40	40	40	4.8	22
ZT6,12,F1,4040,TA,W8	55	6.0	15.4	74	40	40	40	3.9	22
ZT5,16,F1,4040,TA,W8	62	5.0	20	74	40	40	40	3.7	22
ZT8,12,F1,4040,TA,W8	77	8.5	15.4	72	40	40	40	3.8	22
ZT7,16,F1,4040,TA,W8	84	6.7	20	72	40	40	40	3.3	22

Notes: 1) QMax rated value at ΔT = 0°C, I<sub>max</sub> and V<sub>max</sub>, T<sub>h</sub> = 25°C;  
 2) Thickness for non-metallized versions only.  
 All modules are lead-free. For wiring options contact Laird.

# Multi-stage

- Designed for large temperature differential applications
- Custom designs available to meet unique cooling capacity or temp differential requirements
- Ideal for CCD cameras, IR Detectors and Industrial Sensing Instrumentation

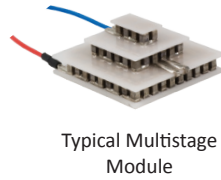

Typical Multistage Module

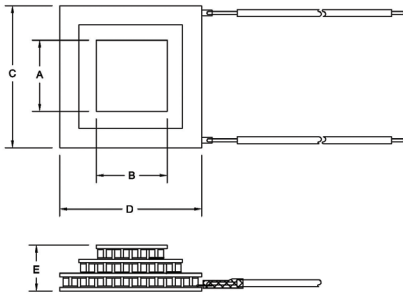

PART NO.	QMAX <sup>(1)</sup> (WATTS)	IMAX (AMPS)	VMAX (VOLTS)	ΔTMAX (°C)	DIM A (mm)	DIM B (mm)	DIM C (mm)	DIM D (mm)	DIM E (mm)
MS2,010,06,06,11,11,11,W2	0.35	1.1	0.9	92	3.2	3.2	3.9	3.9	4.2
MS2,024,06,06,11,11,11,W2	0.81	1.1	2.2	92	4.1	4.1	6.1	6.1	4.6
MS2,065,04,04,11,11,11,W4	1.1	0.5	5.5	82	12	4	14	6	4.7
MS2,049,10,10,15,15,11,W8	3.4	2.1	3.8	87	11.5	11.5	15	15	6.6
MS2,049,14,14,15,15,11,W8	6.6	4	3.8	87	15	15	20	20	7.2
MS2,068,14,14,15,15,11,W8	8.4	5	6.2	92	14.7	14.7	24	24	7.9
MS2,107,10,10,12,12,11,W8	9.2	3	9.2	89	22.6	22.6	22.6	22.6	6.25
MS2,051,22,25,22,25,11,W8	10.5	5.7	3.5	76	26	26	30	30	10.9
MS2,102,14,14,17,17,11,W8	12.1	4.3	8.2	87	20	20	30	30	7.5
MS2,190,10,10,12,12,11,W8	16.4	2.8	15.7	87	30	30	30	30	6.5
MS2,190,10,13,08,20,11,W8	16.4	2.8	15.6	87	30	30	30	30	6.6
MS2,192,14,20,15,25,11,W8	27.3	4.4	16	88	40	40	40	40	8.1
MS2,102,22,22,17,17,11,W8	29	10.3	7.87	87	30	30	44	44	9.1
MS2,192,14,20,11,18,11,W8	39.9	6.7	15.6	87	40	40	40	40	8.1
MS3,052,10,17,11,W8	1.4	1.8	3.3	99	7.2	7.2	15	15	9.8
MS3,070,20,25,11,W8	3	6.5	6.5	118	14	8	36	36	16
MS3,231,10,15,11,W8	6.9	1.9	15.5	104	15	15	30	30	9.5
MS3,119,14,15,11,W8	7.5	3.9	8	100	15	15	30	30	10.4
MS3,119,20,15,11,W8	14.9	8	8.2	100	22	22	44	44	12.9
MS4,108,10,20,11,W8	1.1	1.5	7.87	110	7.1	7.1	18	24	14.6
MS4,129,10,15,11,W8	1.9	1.8	8.2	115	8	8	23	23	12.5
MS4,115,14,15,11,W8	2.6	3.5	7.6	122	14.5	4.5	33	24	13.8
MS5,257,10,15,11,W8	2	1.5	14.5	123	8	8	30	30	15.4

# HiTemp ET Series

- Protects electronics in high temperature environments that operate in excess of 80°C
- Available in multiple configurations
- Designed for higher current and larger heat-pumping applications

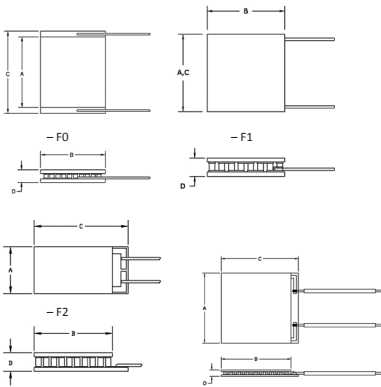

PART NO.	QMAX <sup>(1)</sup> (WATTS)	IMAX (AMPS)	VMAX (VOLTS)	ΔTMAX (°C)	DIM A (mm)	DIM B (mm)	DIM C (mm)	DIM D (mm)	DIM E (mm)
ET08, 32, F0, 0707, 11, W2.25	2.1	0.8	4.7	87	6.5	6.5	8.1	2.4	
ET08, 66, F0, 1009, 11, W2.25	4.3	0.8	9.7	87	9.8	8.9	11.4	2.4	
ET1,8, 31, F1, 0707, 11, W2.25	4.5	1.8	4.6	87	7.8	7.8	7.8	1.1	
ET12, 18, F2A, 0606, 11, W2.25	1.8	1.2	2.7	87	6.1	6.2	7.2	2.7	
ET12, 32, F0, 0808, 11, W2.25	3.1	1.2	4.7	87	8.1	8.1	10.2	2.7	
ET12, 65, F2A, 1212, 11, W2.25	5.3	1.2	7.4	67	13.2	12.1	13.2	2.2	
ET12, 65, F2A, 1312, 11, W2.25	5.3	1.2	7.4	67	13.2	12.1	13.2	2.2	
ET15, 30, F2A, 0610, 11, W2.25	3.6	1.5	4.4	87	6.2	10.3	12.3	2.0	
ET15, 31, F2A, 0909, 11, W2.25	3.7	1.5	4.6	87	8.8	8.8	11.0	2.7	
ET15, 65, F2A, 1312, 11, W2.25	7.7	1.5	9.6	87	13.2	12.1	13.2	2.4	
ET19, 23, F1N, 0608, 11, W2.25	3	1.9	2.7	65	6.0	8.2	6.0	1.65	
ET19, 35, F1N, 0612, 11, W2.25	4.5	1.9	4	67	6.0	12.2	6.0	1.65	
ET20, 24, F2A, 0709, 11, W2.25	3.3	2.0	2.7	67	6.6	8.8	10.8	2.0	
ET20, 30, F2A, 0610, 11, W2.25	4.1	2.0	3.4	67	6.2	10.3	12.3	1.8	
ET20, 31, F1A, 0909, 11, W2.25	4.2	2.0	3.5	67	8.8	8.8	8.8	2.2	
ET20, 65, F2A, 1312, 11, W2.25	10.6	2.0	9.6	87	13.2	12.1	13.2	2.4	
ET20, 68, F1A, 1313, 11, W2.25	9.3	2.0	7.8	67	13.2	13.2	13.2	2.2	
ET2, 12, F2, 3030, TA, W6	23.8	2.3	18.6	87	30	30	34	3.4	
ET2,3, 49, F1, 1919, TA, W6	33	3.2	18.6	87	19.4	19.4	19.4	3.6	
ET2,5, 12, F1, 3030, TA, W4.5	24.5	2.5	18.6	87	30	30	30	4.0	
ET2,6, 6, F1, 1225, TA, W6	10.8	2.0	9.3	87	12.5	25	12.5	3.4	
ET2,6, 6, F1, 1225, TA, W6	13.3	2.6	9.3	87	12.5	25	12.5	3.2	
ET3, 12, F2, 3030, TA, W6	33	3.2	18.6	87	30	30	34	3.6	
ET4, 12, F1, 3030, TA, W4.5	41	3.9	18.6	87	30	30	30	3.2	
ET4, 12, F2, 3030, TA, W6	41	3.8	18.6	87	30	30	34	3.2	
ET4, 12, F2, 4040, TA, W6	39.2	3.9	18.6	87	40	40	44	4.1	
ET4, 31, F1, 1515, TA, W4.5	9.9	3.9	4.6	87	15	15	15	3.2	
ET4, 31, F1, 2020, TA, W6	8.7	3.8	4.6	87	20	20	20	4.7	
ET4, 6, F2, 2138, TA, W6	19.5	3.8	9.3	87	20.6	38.4	43.2	3.8	
ET4, 7, F1, 2323, TA, W4.5	22.8	3.9	10.4	87	23	23	23	3.2	
ET4, 7, F2, 3030, TA, W6	21.9	3.8	10.4	87	30	30	34	4.1	
ET5, 6, F1, 2040, TA, W6	26.3	5.0	9.3	87	20	40	20	3.6	
ET6, 12, F1, 3030, TA, W6	64	6.0	18.6	87	30	30	30	3.2	
ET6, 12, F1, 4040, TA, W6	63	6.0	18.6	87	40	40	40	3.8	
ET6, 19, F1, 4040, TA, W6	96	6.0	29.3	87	40	40	40	3.9	
ET6, 3, F1, 2020, TA, W6	15.2	6.0	4.6	87	20	20	20	3.2	
ET6, 7, F2, 3030, TA, W6	34.9	6.0	10.4	87	30	30	34	3.8	
ET7, 16, F1, 4040, TA, W6	88	6.7	23.7	87	40	40	40	3.2	
ET7, 3, F1, 2020, TA, W4.5	19.4	7.7	4.6	87	20	20	20	3.5	
ET8, 12, F1, 4040, TA, W6	88	8.5	18.6	87	40	40	40	3.3	
ET8, 12, F2, 2525, TA, W6	81	7.8	18.6	87	24.6	24.3	26.9	2.0	
ET8, 28, F2, 5252, TA, W6	200	8.5	42.5	87	52	52	56	3.8	
ET8, 7, F2, 3030, TA, W6	49	8.5	10.4	87	30	30	34	3.3	
ET9, 3, F1, 3030, TA, W6	23.2	9.0	4.6	87	30	30	30	5.6	
ET9, 3, F2, 2525, TA, W6	24.8	9.8	4.6	87	25.4	25.4	28.7	5.0	
ET11, 12, F2, 3030, TA, W6	112	11	18.7	87	30	30	34	2.4	
ET14, 3, F1, 3030, TA, W6	36	14	4.6	87	30	30	30	2.4	
ET15, 12, F2, 4040, TA, W6	149	15	18.7	87	40	40	44	2.8	
ET15, 24, F2, 5252, TA, W6	283	15	35.4	87	52	52	56	3.3	
ET15, 28, F2, 5252, TA, W6	338	15	42.3	87	52	52	56	3.3	
ET25, 12, F2, 6262, TA, W6	258	25	18.6	87	62	62	62	4.1	
ET-MS2, 010, 06, 06, 11, 11, 11 W2	0.3	1.1	1.1	92	3.2	3.2	3.9	3.9	4.2
ET-MS2, 024, 06, 06, 11, 11, 11 W2	0.8	1.1	1.1	92	4.1	4.1	6.1	6.1	4.6
ET-MS2, 192, 14, 20, 11, 18 11, W8	40	6.8	15.8	87	40	40	40	40	8.1

MULTI-STAGE

# Finishing Options

Surface Finish Options	CP	OptoTEC	HiTempET	PolarTEC	UltraTEC	Multistage	Center Hole SH/RH
Metallized Hot/Cold Surface	MM	00	-	-	00	MM	MM
Non-Metallized Hot and/or Cold face	L	11	11	11	11	L	L
Pre-tinning Hot and/or Cold face with 118°C InSn Solder	TT	22	-	-	22	TT	TT
Pre-tinning Hot and/or Cold face with 138°C BiSn Solder	-	33	-	-	-	-	-
Au plating (Hot/Cold Surface)	-	GG	-	-	GG	-	-

**Example:** CP10,127,05TL = Pre-tinned Hot Face (118°C InSn), Non-Metallized Cold Face. Note: Metallization and pretinning are not recommended for module sizes larger than 12 x 12 mm's. Consult datasheet for module thicknesses for each surface finishing option. Contact Laird for finishing options for Multistage Modules.

Thickness Tolerance Options	CP	OptoTEC	HiTempET	PolarTEC	UltraTEC	Multistage	Center Hole SH/RH
+/- 0.001" (0.025 mm)	L1	TA	TA	TA	TA	-	TA
+/- 0.0005" (0.013 mm)	L2	TB	TB	TB	TB	-	TB

**Example:** CP10,127,05,L2 = thickness is 3.2 mm +/- 0.013 mm. Contact Laird for thickness options for Multistage Modules.

Moisture Protection Options	CP	OptoTEC	HiTempET	PolarTEC	UltraTEC	Multistage	Center Hole SH/RH
RTV perimeter seal, Color: Translucent or White	RT	RT	RT	RT	RT	RT	RT
Epoxy perimeter seal, Color: Black	EP	EP	EP	EP	EP	EP	EP

**Example:** CP10,127,05,L2,RT = RTV silicone perimeter seal

Silicone (RTV) is an all purpose sealant that exhibits good sealing characteristics and retains its elastomeric properties over a wide temperature range, -60 to 200°C.

The sealant is non-corrosive to many chemicals and exhibits good electrical properties with low thermal conductivity.

Epoxy (EP) is an effective barrier to moisture that exhibits a useable temperature range of -40 to 130°C. When cured the material is completely uni-cellular and therefore the moisture absorption is negligible. The material exhibits a low dielectric constant, low coefficient of thermal expansion and low shrinkage.

Wire Options	CP	OptoTEC	HiTempET	PolarTEC	UltraTEC	Multistage	Center Hole SH/RH
Custom lead length # in inches, (S denotes special requirement)	W#	W#	W#	W#	W#	W#	W#

**Example:** CP10,127,05,L2,W8 = Wire length is 8" (203 mm). Reference datasheet for standard lead length, wire type and insulation sleeving.

Consult with Laird for wire bondable posts or thru hole mount.

# Thermal Wizard

The Thermal Wizard is an online tool that allows engineers to specify a given set of input variables based on application attributes and model the performance of the TEM prior to trial. The tool contains several application examples and an active datasheet that simulates how the TEM(s) will function under a specific set of operating conditions. Available only online, the Thermal Wizard is accessible from the Laird website at [lairdtech.com/thermal-wizard](http://lairdtech.com/thermal-wizard).

Find the best thermal solution based on your requirements - match your requirements to our standard product lines or request a [Custom Solution](#).

**Thermoelectric Modules - Thermoelectric Assemblies - Liquid Cooling Systems - Custom Cooling Solutions**

Most Laird active thermal products can be customized or configured to meet your exact requirements. Laird's engineering team and rapid prototyping services are available to assist you with concept generation, thermal modeling, mechanical and electrical design to deliver the optimized thermal management solution.

- With the Wizard, you can also:
- Check for availability
  - Request a sample
  - Request a quote
  - Talk to a technical expert

Need to calculate your Cooling Requirement? Use the Thermal Wizard Qc Calculators



DEVICE COOLING CALCULATOR



ENCLOSURE COOLING CALCULATOR



AIR COOLING CALCULATOR



LIQUID COOLING CALCULATOR

Know your Cooling Requirement (Qc)? Move a slider to the desired Qc and click SEARCH

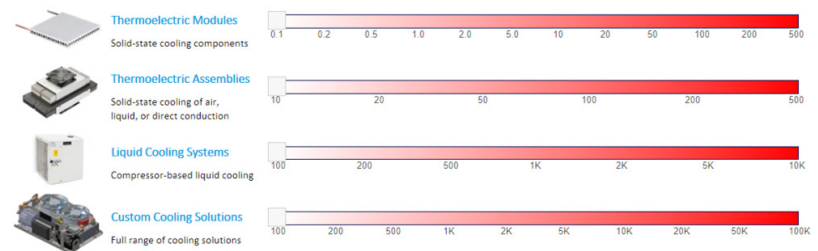

Cooling Requirement - Qc  Watts  $\Delta T = 0$  °C  Click SEARCH to view thermal solutions



Americas: +1.919.597.7300

Europe: +46.31.420530

Asia: +86.755.2714.1166

[www.lairdtech.com/thermal-wizard](http://www.lairdtech.com/thermal-wizard)

THR-BRO-THERMOELECTRIC MODULES\_07022018

Any information furnished by Laird and its agents is believed to be accurate and reliable. All specifications are subject to change without notice. Responsibility for the use and application of Laird materials rests with the end user, since Laird and its agents cannot be aware of all potential uses. Laird makes no warranties as to the fitness, merchantability or suitability of any Laird materials or products for any specific or general uses. Laird, Laird Technologies, Inc or any of its affiliates or agents shall not be liable for incidental or consequential damages of any kind. All Laird products are sold pursuant to the Laird Technologies' Terms and Conditions of sale in effect from time to time, a copy of which will be furnished upon request. © Copyright 2017 Laird Technologies, Inc. All Rights Reserved. Laird, Laird Technologies, the Laird Logo, and other marks are trademarks or registered trademarks of Laird Technologies, Inc. or an affiliate company thereof. Other product or service names may be the property of third parties. Nothing herein provides a license under any Laird or any third party intellectual property rights.



## X-ON Electronics

Largest Supplier of Electrical and Electronic Components

*Click to view similar products for [Thermoelectric Modules](#) category:*

*Click to view products by [Laird Connectivity](#) manufacturer:*

Other Similar products are found below :

[C3100-1980](#) [C3200-0504](#) [C3200-0505](#) [C3200-371](#) [C3400-0262](#) [430084-505](#) [430848-514](#) [44710-500](#) [430141-508](#) [430005-517](#) [CP85438](#)  
[66101-500](#) [CP40136](#) [CP60133](#) [CP60140](#) [CP30238](#) [CP20251](#) [CP85338](#) [CP20151](#) [430082-502](#) [430078-525](#) [CP14,31,10,L1,W4.5](#)  
[HT4,12,F2,4040,TA,W6](#) [MS3,119,14,15,11,W8](#) [MS5,257,10,15,11,W8](#) [MS2,107,10,10,12,12,11,W8](#) [ZT5,16,F1,4040,TA,W8](#) [58910-501](#)  
[UT15,200,F2,4040,TA,W6](#) [UT8,288,F2,5252,TA,W6](#) [UT8,200,F2,4040,TA,W6](#) [CP12,161,04,L1,W4.5](#) [430719-502](#)  
[ET20,31,F1A,0909,11,W2.25](#) [ET19,23,F1N,0608,11,W2.25](#) [430362-502](#) [HT8,12,F2,4040,TA,W6](#) [430138-506](#) [430078-501](#)  
[PT6,12,F2,4040,TA,W6](#) [430032-502](#) [OT12,66,F0,1211,11,W2.25](#) [OT12,12,F0,0406,11,W2.25](#) [MS2,010,06,06,11,11, 11,W2,ET](#) [CP20247H](#)  
[CP85301535](#) [CP35447](#) [CP60131H](#) [CPM-2F](#) [CP853345H](#)