



RAYSTAR

曜凌光電股份有限公司

住址: 42878 台中市大雅区科雅路 25 號 5F WEB: <http://www.Raystar-Optronics.com>
5F., No.25, Keya Rd., Daya Dist., Taichung E-mail: sales@raystar-optronics.com
City 428, Taiwan Tel:886-4-2565-0761 Fax : 886-4-2565-0760

RG24064A-YHW-V

SPECIFICATION

CUSTOMER:

APPROVED BY	
PCB VERSION	
DATE	

FOR CUSTOMER USE ONLY

SALES BY	APPROVED BY	CHECKED BY	PREPARED BY

Release DATE:

Revision History

VERSION	DATE	REVISED PAGE NO.	Note
0	2012/04/10		First issue
A	2013/10/08		Modify Backlight Information
			Modify Absolute Maximum Ratings
B	2014/09/03		Remove IC information

RAYSTAR OPTRONICS

Contents

- 1.General Specification
- 2.Module Classification Information
- 3.Interface Pin Function
- 4.Contour Drawing &Block Diagram
- 5.Optical Characteristics
- 6.Absolute Maximum Ratings
- 7.Electrical Characteristics
- 8.Backlight Information
- 9.Reliability
- 10.Inspection specification
- 11.Precautions in use of LCD Modules
- 12.Material List of Components for RoHs
- 13.Recommendable Storage

1. General Specification

The Features is described as follow:

- Module dimension: 180.0 x 65.0 x 12.3 (max.) mm
- View area: 133.0 x 39.0 mm
- Active area: 127.16 x 33.88 mm
- Number of dots: 240 x 64
- Dot size: 0.49 x 0.49 mm
- Dot pitch: 0.53 x 0.53 mm
- LCD type: STN Positive, Yellow Green Transflective
- Duty: 1/64
- View direction: 6 o'clock
- Backlight Type: LED White
- IC:RA6963

RAYSTAR OPTRONICS

2.Module Classification Information

<u>R</u>	<u>G</u>	<u>24064</u>	<u>A</u>	—	<u>Y</u>	<u>H</u>	<u>W</u>	—	<u>V</u>
①	②	③	④	—	⑤	⑥	⑦	—	⑧

Item	Description			
1	R : Raystar Optronics Inc.			
2	Display	C : Character Type,	T:TAB Type	
		G : Graphic Type	X:COG Type	
3	Display Font : 240 * 64 dot			
4	Serials code :			
5	LCD	P→TN Positive, Gray	V→FSTN Negative, Blue	
		N→TN Negative,	T→FSTN Negative, Black	
		L→VA Negative	D→FSTN Negative (Double film)	
		H→ HTN Positive, Gray	F→FSTN Positive	
		I→HTN Negative, Black	K→FSC Negative	
		U→HTN Negative, Blue	S→FSC Positive	
		B→STN Negative, Blue	E→ISTN Negative, Black	
		G→STN Positive, Gray	C→CSTN Negative, Black	
		Y→STN Positive, Yellow Green	A→ASTN Negative, Black	
6	Polarizer Type, Temperature range, View direction	A : Reflective, N.T, 6:00	K : Transflective, W.T,12:00	
		D : Reflective, N.T, 12:00	1 : Transflective, U.T,6:00	
		G : Reflective, W. T, 6:00	4 : Transflective, U.T.12:00	
		J : Reflective, W. T, 12:00	C : Transmissive, N.T,6:00	
		0 : Reflective, U. T, 6:00	F : Transmissive, N.T,12:00	
		3 : Reflective, U. T, 12:00	I : Transmissive, W. T, 6:00	
		B : Transflective, N.T,6:00	L : Transmissive, W.T,12:00	
		E : Transflective, N.T.12:00	2 : Transmissive, U. T, 6:00	
		H : Transflective, W.T,6:00	5 : Transmissive, U.T,12:00	
7	Backlight	N→ Without backlight	W→LED, White	H→LED, High light White
		P→EL, Blue	A→LED, Amber	S→LED, Full color
		T→EL, Green	R→LED, Red	J→DIP LED, Blue
		D→EL, White	O→LED, Orange	K→DIP LED, White
		M→EL, Yellow Green	B→LED, Blue	E→DIP LED, Yellow
		F→CCFL, White	X→LED, Dual color	L→DIP LED, Amber
		Y→LED, Yellow Green	C→LED, Full color	I→DIP LED, Red
		G→LED, Green		
8	Special code	V : Build in negative voltage		

3.Interface Pin Function

Pin No.	Symbol	Level	Description
1	FG	—	Frame ground (Connected to bezel)
2	Vss	—	GND
3	Vdd	—	Power supply
4	Vo	—	Power supply for LCD driver
5	/WR	L	Data write. Write data into RA6963 when WR = L
6	/RD	L	Data read. Read data from RA6963 when RD = L
7	/CE	L	L : Chip enable
8	C/D	H / L	WR=L , C/D=H : Command Write C/D=L: Data write RD=L , C/D=H : Status Read C/D=L: Data read
9	Vee	—	Negative voltage output
10	/RESET	H / L	H : Normal ; L : Initialize RA6963
11	DB0	H / L	Data bus line
12	DB1	H / L	Data bus line
13	DB2	H / L	Data bus line
14	DB3	H / L	Data bus line
15	DB4	H / L	Data bus line
16	DB5	H / L	Data bus line
17	DB6	H / L	Data bus line
18	DB7	H / L	Data bus line
19	FS	H / L	Pins for selection of font; H : 6 * 8 , L : 8 * 8
20	NC	—	No connection

4. Contour Drawing & Block Diagram

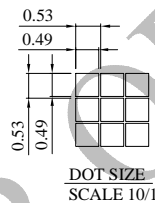
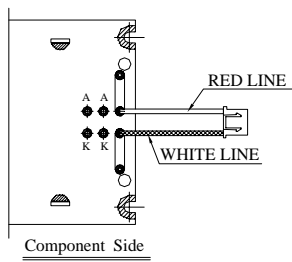
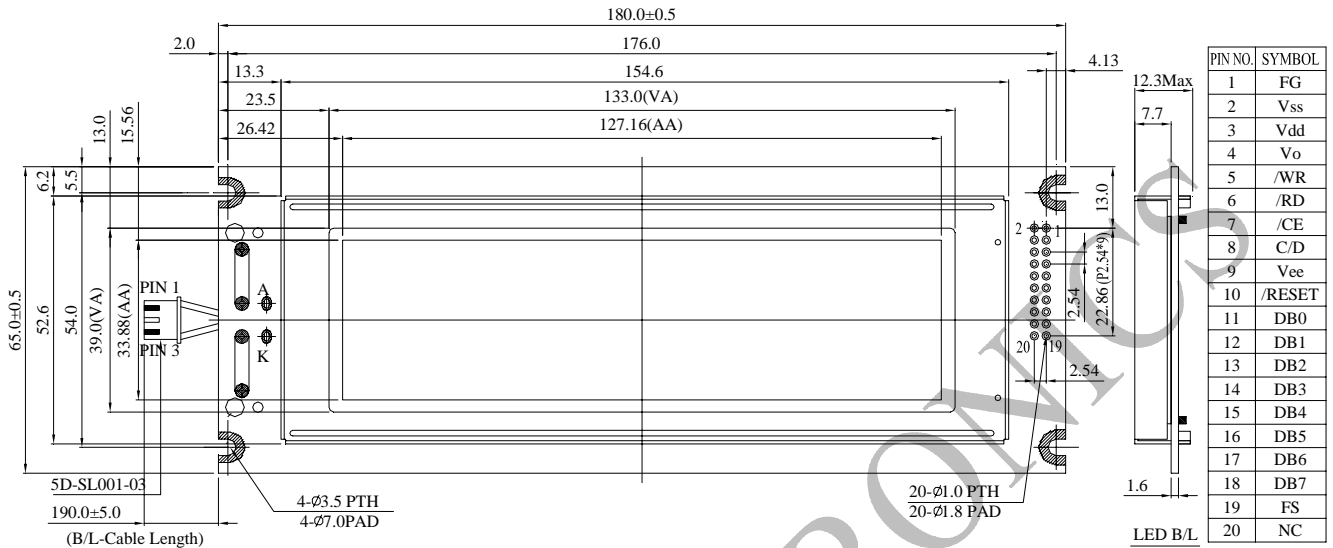

The non-specified tolerance of dimension is ±0.3 mm .

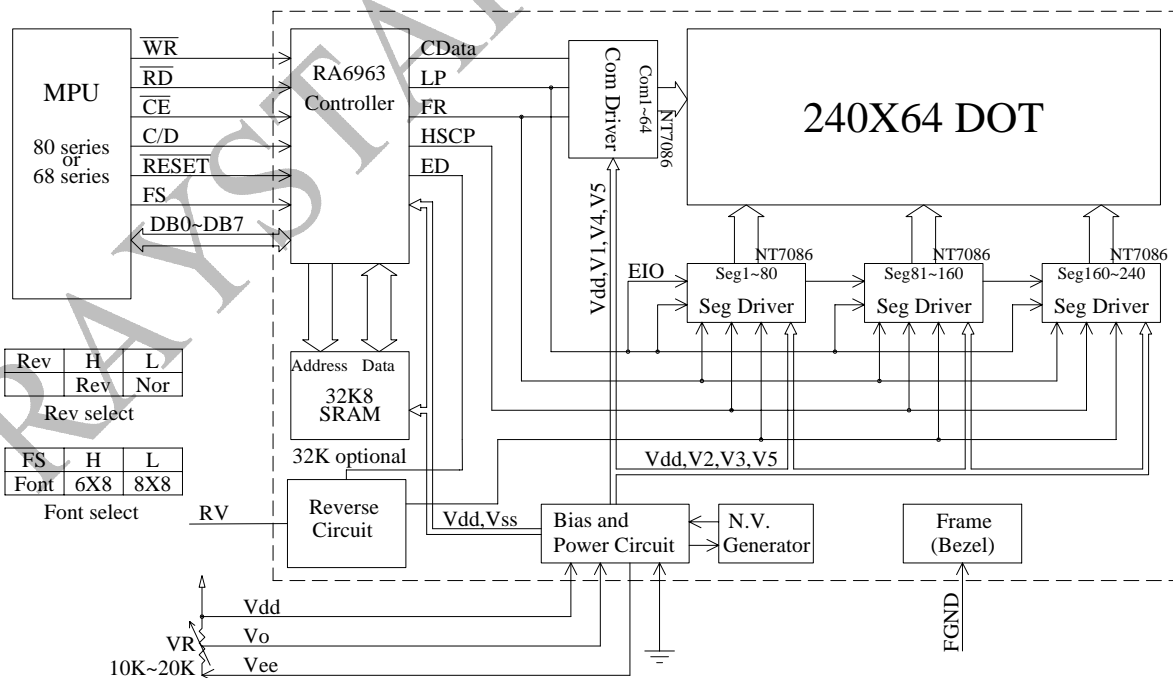

External contrast adjustment.

5. Optical Characteristics

Item	Symbol	Condition	Min	Typ	Max	Unit
View Angle	θ	$CR \geq 2$	0	—	20	$\psi = 180^\circ$
	θ	$CR \geq 2$	0	—	40	$\psi = 0^\circ$
	θ	$CR \geq 2$	0	—	30	$\psi = 90^\circ$
	θ	$CR \geq 2$	0	—	30	$\psi = 270^\circ$
Contrast Ratio	CR	—	—	3	—	—
Response Time	T rise	—	—	200	300	ms
	T fall	—	—	250	350	ms

Definition of Operation Voltage (Vop)

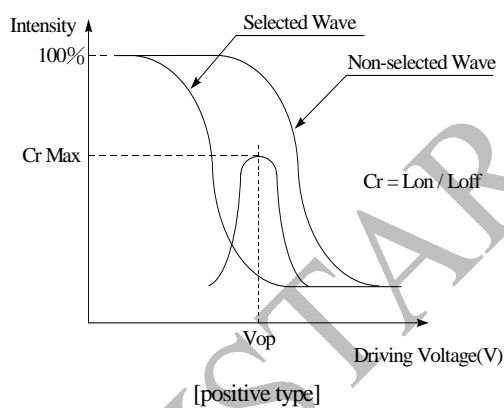

Definition of Response Time (Tr, Tf)

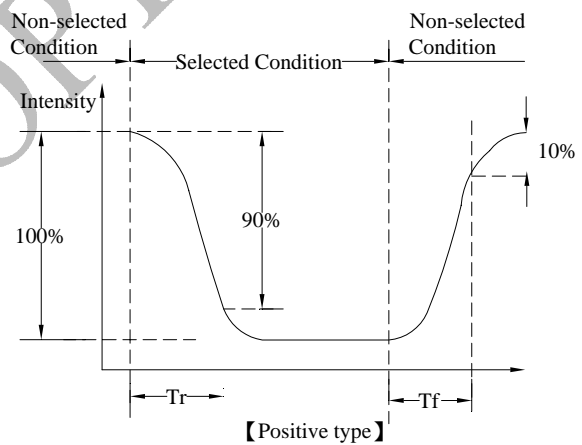

Conditions :

Operating Voltage : Vop

Viewing Angle(θ, ϕ) : $0^\circ, 0^\circ$

Frame Frequency : 64 HZ Driving Waveform : 1/N duty , 1/a bias

Definition of viewing angle($CR \geq 2$)

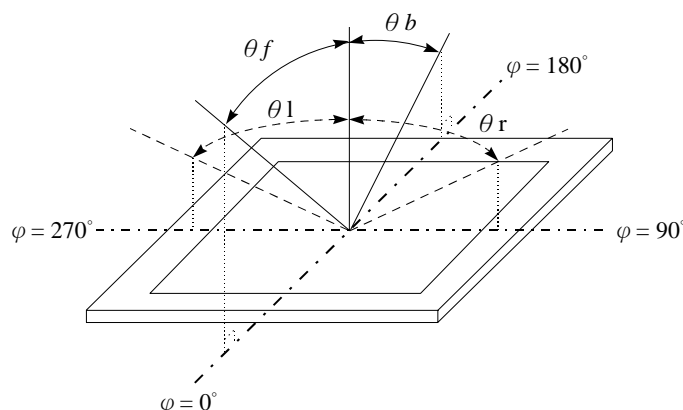

6. Absolute Maximum Ratings

Item	Symbol	Min	Typ	Max	Unit
Operating Temperature	T_{OP}	-20	—	+70	$^{\circ}C$
Storage Temperature	T_{ST}	-30	—	+80	$^{\circ}C$
Input Voltage	V_{IN}	-0.3	—	$V_{DD}+0.3$	V
Supply Voltage For Logic	$V_{DD}-V_{SS}$	-0.3	—	+7.0	V

RAYSTAR OPTRONICS

7. Electrical Characteristics

Item	Symbol	Condition	Min	Typ	Max	Unit
Supply Voltage For Logic	$V_{DD}-V_{SS}$	—	3.0	—	5.5	V
Supply Voltage For LCD	$V_{DD}-V_0$	Ta=-20°C	—	—	13.9	V
*Note		Ta=25°C	12.1	12.5	12.9	V
		Ta=70°C	10.1	—	—	V
Input High Volt.	V_{IH}	—	0.8V _{DD}	—	V _{DD}	V
Input Low Volt.	V_{IL}	—	0	—	0.2 V _{DD}	V
Output High Volt.	V_{OH}	—	V _{DD} -0.3	—	V _{DD}	V
Output Low Volt.	V_{OL}	—	0	—	0.3	V
Supply Current	I_{DD}	—	12	16	20	mA

* Note: Please design the VOP adjustment circuit on customer's main board

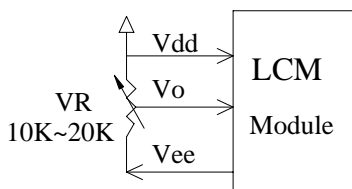

8.Backlight Information

Specification

PARAMETER	SYMBOL	MIN	TYP	MAX	UNIT	TEST CONDITION
Supply Current	I _{LED}	—	80	100	mA	V=3.5V
Supply Voltage	V	3.4	3.5	3.6	V	—
Reverse Voltage	V _R	—	—	5	V	—
Luminance (Without LCD)	I _V	520	650	—	CD/M ²	I _{LED} =80mA
LED Life Time (For Reference only)	—	—	50K	—	Hr.	I _{LED} =80mA 25°C,50-60%RH, (Note 1)
Color	White					

Note: The LED of B/L is drive by current only, drive voltage is for reference only. drive voltage can make driving current under safety area (current between minimum and maximum).

Note 1:50K hours is only an estimate for reference.

LED B\L Drive Method

1.Drive from A , K

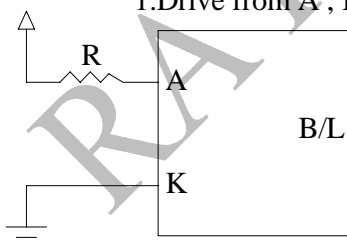

9. Reliability

Content of Reliability Test (Wide temperature, -20°C~70°C)

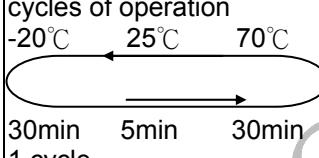
Environmental Test			
Test Item	Content of Test	Test Condition	Note
High Temperature storage	Endurance test applying the high storage temperature for a long time.	80°C 200hrs	2
Low Temperature storage	Endurance test applying the low storage temperature for a long time.	-30°C 200hrs	1,2
High Temperature Operation	Endurance test applying the electric stress (Voltage & Current) and the thermal stress to the element for a long time.	70°C 200hrs	—
Low Temperature Operation	Endurance test applying the electric stress under low temperature for a long time.	-20°C 200hrs	1
High Temperature/ Humidity storage	The module should be allowed to stand at 60°C,90%RH max For 96hrs under no-load condition excluding the polarizer, Then taking it out and drying it at normal temperature.	60°C,90%RH 96hrs	1,2
Thermal shock resistance	The sample should be allowed stand the following 10 cycles of operation 	-20°C/70°C 10 cycles	—
Vibration test	Endurance test applying the vibration during transportation and using.	Total fixed amplitude : 1.5mm Vibration Frequency : 10~55Hz One cycle 60 seconds to 3 directions of X,Y,Z for Each 15 minutes	3
Static electricity test	Endurance test applying the electric stress to the terminal.	VS=800V,RS=1.5kΩ CS=100pF 1 time	—

Note1: No dew condensation to be observed.

Note2: The function test shall be conducted after 4 hours storage at the normal Temperature and humidity after remove from the test chamber.

Note3: The packing have to including into the vibration testing.

10. Inspection specification

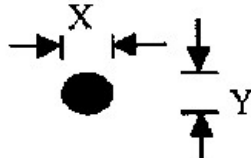
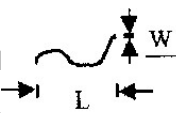
NO	Item	Criterion	AQL												
01	Electrical Testing	1.1 Missing vertical, horizontal segment, segment contrast defect. 1.2 Missing character , dot or icon. 1.3 Display malfunction. 1.4 No function or no display. 1.5 Current consumption exceeds product specifications. 1.6 LCD viewing angle defect. 1.7 Mixed product types. 1.8 Contrast defect.	0.65												
02	Black or white spots on LCD (display only)	2.1 White and black spots on display $\leq 0.25\text{mm}$, no more than three white or black spots present. 2.2 Densely spaced: No more than two spots or lines within 3mm	2.5												
03	LCD black spots, white spots, contamination (non-display)	3.1 Round type : As following drawing $\Phi = (x + y) / 2$  <table border="1"> <thead> <tr> <th>SIZE</th> <th>Acceptable Q TY</th> </tr> </thead> <tbody> <tr> <td>$\Phi \leq 0.10$</td> <td>Accept no dense</td> </tr> <tr> <td>$0.10 < \Phi \leq 0.20$</td> <td>2</td> </tr> <tr> <td>$0.20 < \Phi \leq 0.25$</td> <td>1</td> </tr> <tr> <td>$0.25 < \Phi$</td> <td>0</td> </tr> </tbody> </table>	SIZE	Acceptable Q TY	$\Phi \leq 0.10$	Accept no dense	$0.10 < \Phi \leq 0.20$	2	$0.20 < \Phi \leq 0.25$	1	$0.25 < \Phi$	0	2.5		
		SIZE	Acceptable Q TY												
$\Phi \leq 0.10$	Accept no dense														
$0.10 < \Phi \leq 0.20$	2														
$0.20 < \Phi \leq 0.25$	1														
$0.25 < \Phi$	0														
3.2 Line type : (As following drawing)  <table border="1"> <thead> <tr> <th>Length</th> <th>Width</th> <th>Acceptable Q TY</th> </tr> </thead> <tbody> <tr> <td>---</td> <td>$W \leq 0.02$</td> <td>Accept no dense</td> </tr> <tr> <td>$L \leq 3.0$</td> <td>$0.02 < W \leq 0.03$</td> <td rowspan="2">2</td> </tr> <tr> <td>$L \leq 2.5$</td> <td>$0.03 < W \leq 0.05$</td> </tr> <tr> <td>---</td> <td>$0.05 < W$</td> <td>As round type</td> </tr> </tbody> </table>	Length	Width	Acceptable Q TY	---	$W \leq 0.02$	Accept no dense	$L \leq 3.0$	$0.02 < W \leq 0.03$	2	$L \leq 2.5$	$0.03 < W \leq 0.05$	---	$0.05 < W$	As round type	2.5
Length	Width	Acceptable Q TY													
---	$W \leq 0.02$	Accept no dense													
$L \leq 3.0$	$0.02 < W \leq 0.03$	2													
$L \leq 2.5$	$0.03 < W \leq 0.05$														
---	$0.05 < W$	As round type													
04	Polarizer bubbles	If bubbles are visible, judge using black spot specifications, not easy to find, must check in specify direction. <table border="1"> <thead> <tr> <th>Size Φ</th> <th>Acceptable Q TY</th> </tr> </thead> <tbody> <tr> <td>$\Phi \leq 0.20$</td> <td>Accept no dense</td> </tr> <tr> <td>$0.20 < \Phi \leq 0.50$</td> <td>3</td> </tr> <tr> <td>$0.50 < \Phi \leq 1.00$</td> <td>2</td> </tr> <tr> <td>$1.00 < \Phi$</td> <td>0</td> </tr> <tr> <td>Total Q TY</td> <td>3</td> </tr> </tbody> </table>	Size Φ	Acceptable Q TY	$\Phi \leq 0.20$	Accept no dense	$0.20 < \Phi \leq 0.50$	3	$0.50 < \Phi \leq 1.00$	2	$1.00 < \Phi$	0	Total Q TY	3	2.5
Size Φ	Acceptable Q TY														
$\Phi \leq 0.20$	Accept no dense														
$0.20 < \Phi \leq 0.50$	3														
$0.50 < \Phi \leq 1.00$	2														
$1.00 < \Phi$	0														
Total Q TY	3														

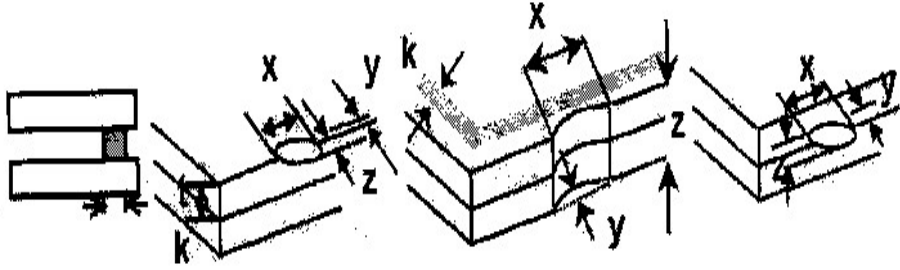
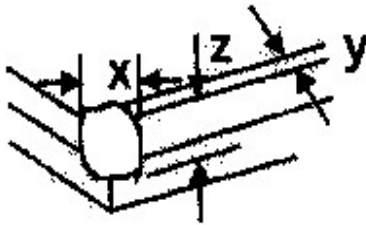
NO	Item	Criterion	AQL																		
05	Scratches	Follow NO.3 LCD black spots, white spots, contamination																			
06	Chipped glass	<p>Symbols Define: x: Chip length y: Chip width z: Chip thickness k: Seal width t: Glass thickness a: LCD side length L: Electrode pad length:</p> <p>6.1 General glass chip : 6.1.1 Chip on panel surface and crack between panels:</p>  <table border="1" data-bbox="443 1025 1353 1236"> <thead> <tr> <th>z: Chip thickness</th> <th>y: Chip width</th> <th>x: Chip length</th> </tr> </thead> <tbody> <tr> <td>$Z \leq 1/2t$</td> <td>Not over viewing area</td> <td>$x \leq 1/8a$</td> </tr> <tr> <td>$1/2t < z \leq 2t$</td> <td>Not exceed 1/3k</td> <td>$x \leq 1/8a$</td> </tr> </tbody> </table> <p>⊙ If there are 2 or more chips, x is total length of each chip.</p> <p>6.1.2 Corner crack:</p>  <table border="1" data-bbox="443 1668 1353 1879"> <thead> <tr> <th>z: Chip thickness</th> <th>y: Chip width</th> <th>x: Chip length</th> </tr> </thead> <tbody> <tr> <td>$Z \leq 1/2t$</td> <td>Not over viewing area</td> <td>$x \leq 1/8a$</td> </tr> <tr> <td>$1/2t < z \leq 2t$</td> <td>Not exceed 1/3k</td> <td>$x \leq 1/8a$</td> </tr> </tbody> </table> <p>⊙ If there are 2 or more chips, x is the total length of each chip.</p>	z: Chip thickness	y: Chip width	x: Chip length	$Z \leq 1/2t$	Not over viewing area	$x \leq 1/8a$	$1/2t < z \leq 2t$	Not exceed 1/3k	$x \leq 1/8a$	z: Chip thickness	y: Chip width	x: Chip length	$Z \leq 1/2t$	Not over viewing area	$x \leq 1/8a$	$1/2t < z \leq 2t$	Not exceed 1/3k	$x \leq 1/8a$	2.5
z: Chip thickness	y: Chip width	x: Chip length																			
$Z \leq 1/2t$	Not over viewing area	$x \leq 1/8a$																			
$1/2t < z \leq 2t$	Not exceed 1/3k	$x \leq 1/8a$																			
z: Chip thickness	y: Chip width	x: Chip length																			
$Z \leq 1/2t$	Not over viewing area	$x \leq 1/8a$																			
$1/2t < z \leq 2t$	Not exceed 1/3k	$x \leq 1/8a$																			

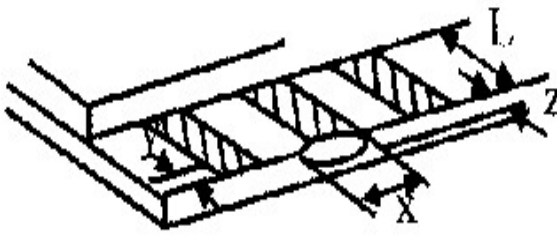
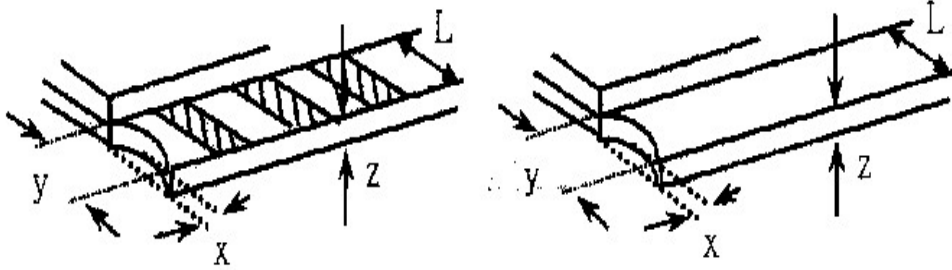
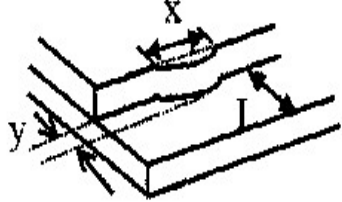
NO	Item	Criterion	AQL																
06	Glass crack	<p>Symbols :</p> <p>x: Chip length y: Chip width z: Chip thickness k: Seal width t: Glass thickness a: LCD side length L: Electrode pad length</p> <p>6.2 Protrusion over terminal :</p> <p>6.2.1 Chip on electrode pad :</p>  <table border="1" data-bbox="363 907 1284 1008"> <tr> <td>y: Chip width</td> <td>x: Chip length</td> <td>z: Chip thickness</td> </tr> <tr> <td>$y \leq 0.5\text{mm}$</td> <td>$x \leq 1/8a$</td> <td>$0 < z \leq t$</td> </tr> </table> <p>6.2.2 Non-conductive portion:</p>  <table border="1" data-bbox="434 1388 1260 1505"> <tr> <td>y: Chip width</td> <td>x: Chip length</td> <td>z: Chip thickness</td> </tr> <tr> <td>$y \leq L$</td> <td>$x \leq 1/8a$</td> <td>$0 < z \leq t$</td> </tr> </table> <p>⊙ If the chipped area touches the ITO terminal, over 2/3 of the ITO must remain and be inspected according to electrode terminal specifications.</p> <p>⊙ If the product will be heat sealed by the customer, the alignment mark not be damaged.</p> <p>6.2.3 Substrate protuberance and internal crack.</p>  <table border="1" data-bbox="774 1809 1332 1908"> <tr> <td>y: width</td> <td>x: length</td> </tr> <tr> <td>$y \leq 1/3L$</td> <td>$x \leq a$</td> </tr> </table>	y: Chip width	x: Chip length	z: Chip thickness	$y \leq 0.5\text{mm}$	$x \leq 1/8a$	$0 < z \leq t$	y: Chip width	x: Chip length	z: Chip thickness	$y \leq L$	$x \leq 1/8a$	$0 < z \leq t$	y: width	x: length	$y \leq 1/3L$	$x \leq a$	2.5
y: Chip width	x: Chip length	z: Chip thickness																	
$y \leq 0.5\text{mm}$	$x \leq 1/8a$	$0 < z \leq t$																	
y: Chip width	x: Chip length	z: Chip thickness																	
$y \leq L$	$x \leq 1/8a$	$0 < z \leq t$																	
y: width	x: length																		
$y \leq 1/3L$	$x \leq a$																		

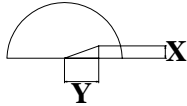
NO	Item	Criterion	AQL
07	Cracked glass	The LCD with extensive crack is not acceptable.	2.5
08	Backlight elements	8.1 Illumination source flickers when lit. 8.2 Spots or scratched that appear when lit must be judged. Using LCD spot, lines and contamination standards. 8.3 Backlight doesn't light or color wrong.	0.65 2.5 0.65
09	Bezel	9.1 Bezel may not have rust, be deformed or have fingerprints, stains or other contamination. 9.2 Bezel must comply with job specifications.	2.5 0.65
10	PCB · COB	10.1 COB seal may not have pinholes larger than 0.2mm or contamination. 10.2 COB seal surface may not have pinholes through to the IC. 10.3 The height of the COB should not exceed the height indicated in the assembly diagram. 10.4 There may not be more than 2mm of sealant outside the seal area on the PCB. And there should be no more than three places. 10.5 No oxidation or contamination PCB terminals. 10.6 Parts on PCB must be the same as on the production characteristic chart. There should be no wrong parts, missing parts or excess parts. 10.7 The jumper on the PCB should conform to the product characteristic chart. 10.8 If solder gets on bezel tab pads, LED pad, zebra pad or screw hold pad, make sure it is smoothed down. 10.9 The Scraping testing standard for Copper Coating of PCB  $X * Y \leq 2\text{mm}^2$	2.5 2.5 0.65 2.5 2.5 0.65 0.65 2.5 2.5
11	Soldering	11.1 No un-melted solder paste may be present on the PCB. 11.2 No cold solder joints, missing solder connections, oxidation or icicle. 11.3 No residue or solder balls on PCB. 11.4 No short circuits in components on PCB.	2.5 2.5 2.5 0.65

NO	Item	Criterion	AQL
12	General appearance	12.1 No oxidation, contamination, curves or, bends on interface Pin (OLB) of TCP.	2.5
		12.2 No cracks on interface pin (OLB) of TCP.	0.65
		12.3 No contamination, solder residue or solder balls on product.	2.5
		12.4 The IC on the TCP may not be damaged, circuits.	2.5
		12.5 The uppermost edge of the protective strip on the interface pin must be present or look as if it cause the interface pin to sever.	2.5
		12.6 The residual rosin or tin oil of soldering (component or chip component) is not burned into brown or black color.	2.5
		12.7 Sealant on top of the ITO circuit has not hardened.	0.65
		12.8 Pin type must match type in specification sheet.	0.65
		12.9 LCD pin loose or missing pins.	0.65
		12.10 Product packaging must the same as specified on packaging specification sheet.	0.65
		12.11 Product dimension and structure must conform to product specification sheet.	0.65
		12.12 Visual defect outside of VA is not considered to be rejection.	

RAYSTAR OPTRONICS

11. Precautions in use of LCD Modules

- (1) Avoid applying excessive shocks to the module or making any alterations or modifications to it.
- (2) Don't make extra holes on the printed circuit board, modify its shape or change the components of LCD module.
- (3) Don't disassemble the LCM.
- (4) Don't operate it above the absolute maximum rating.
- (5) Don't drop, bend or twist LCM.
- (6) Soldering: only to the I/O terminals.
- (7) Storage: please storage in anti-static electricity container and clean environment.
- (8) Raystar have the right to change the passive components, including R3,R6 & backlight adjust resistors. (Resistors, capacitors and other passive components will have different appearance and color caused by the different supplier.)
- (9) Raystar have the right to change the PCB Rev. (In order to satisfy the supplying stability, management optimization and the best product performance...etc, under the premise of not affecting the electrical characteristics and external dimensions, Raystar have the right to modify the version.)

12. Material List of Components for RoHs

1. RAYSTAR Display Co., Ltd hereby declares that all of or part of products (with the mark “#”in code), including, but not limited to, the LCM, accessories or packages, manufactured and/or delivered to your company (including your subsidiaries and affiliated company) directly or indirectly by our company (including our subsidiaries or affiliated companies) do not intentionally contain any of the substances listed in all applicable EU directives and regulations, including the following substances.

Exhibit A : The Harmful Material List

Material	(Cd)	(Pb)	(Hg)	(Cr6+)	PBBs	PBDEs
Limited Value	100 ppm	1000 ppm	1000 ppm	1000 ppm	1000 ppm	1000 ppm
Above limited value is set up according to RoHS.						

2. Process for RoHS requirement :

- (1) Use the Sn/Ag/Cu soldering surface ; the surface of Pb-free solder is rougher than we used before.
- (2) Heat-resistance temp. :
 Reflow : 250°C, 30 seconds Max. ;
 Connector soldering wave or hand soldering : 320°C, 10 seconds max.
- (3) Temp. curve of reflow, max. Temp. : 235±5°C ;
 Recommended customer's soldering temp. of connector : 280°C, 3 seconds.

13.Recommendable Storage

1. Place the panel or module in the temperature $25^{\circ}\text{C}\pm 5^{\circ}\text{C}$ and the humidity below 65% RH
2. Do not place the module near organics solvents or corrosive gases.
3. Do not crush, shake, or jolt the module.

RAYSTAR OPTRONICS

LCM Sample Estimate Feedback Sheet

Module Number : _____

1 、 Panel Specification :

1. Panel Type :	<input type="checkbox"/> Pass	<input type="checkbox"/> NG , _____
2. View Direction :	<input type="checkbox"/> Pass	<input type="checkbox"/> NG , _____
3. Numbers of Dots :	<input type="checkbox"/> Pass	<input type="checkbox"/> NG , _____
4. View Area :	<input type="checkbox"/> Pass	<input type="checkbox"/> NG , _____
5. Active Area :	<input type="checkbox"/> Pass	<input type="checkbox"/> NG , _____
6. Operating Temperature :	<input type="checkbox"/> Pass	<input type="checkbox"/> NG , _____
7. Storage Temperature :	<input type="checkbox"/> Pass	<input type="checkbox"/> NG , _____
8. Others :	_____	

2 、 Mechanical Specification :

1. PCB Size :	<input type="checkbox"/> Pass	<input type="checkbox"/> NG , _____
2. Frame Size :	<input type="checkbox"/> Pass	<input type="checkbox"/> NG , _____
3. Material of Frame :	<input type="checkbox"/> Pass	<input type="checkbox"/> NG , _____
4. Connector Position :	<input type="checkbox"/> Pass	<input type="checkbox"/> NG , _____
5. Fix Hole Position :	<input type="checkbox"/> Pass	<input type="checkbox"/> NG , _____
6. Backlight Position :	<input type="checkbox"/> Pass	<input type="checkbox"/> NG , _____
7. Thickness of PCB :	<input type="checkbox"/> Pass	<input type="checkbox"/> NG , _____
8. Height of Frame to PCB :	<input type="checkbox"/> Pass	<input type="checkbox"/> NG , _____
9. Height of Module :	<input type="checkbox"/> Pass	<input type="checkbox"/> NG , _____
10. Others :	<input type="checkbox"/> Pass	<input type="checkbox"/> NG , _____

3 、 Relative Hole Size :

1. Pitch of Connector :	<input type="checkbox"/> Pass	<input type="checkbox"/> NG , _____
2. Hole size of Connector :	<input type="checkbox"/> Pass	<input type="checkbox"/> NG , _____
3. Mounting Hole size :	<input type="checkbox"/> Pass	<input type="checkbox"/> NG , _____
4. Mounting Hole Type :	<input type="checkbox"/> Pass	<input type="checkbox"/> NG , _____
5. Others :	<input type="checkbox"/> Pass	<input type="checkbox"/> NG , _____

4 、 Backlight Specification :

1. B/L Type :	<input type="checkbox"/> Pass	<input type="checkbox"/> NG , _____
2. B/L Color :	<input type="checkbox"/> Pass	<input type="checkbox"/> NG , _____
3. B/L Driving Voltage (Reference for LED Type) :	<input type="checkbox"/> Pass	<input type="checkbox"/> NG , _____
4. B/L Driving Current :	<input type="checkbox"/> Pass	<input type="checkbox"/> NG , _____
5. Brightness of B/L :	<input type="checkbox"/> Pass	<input type="checkbox"/> NG , _____
6. B/L Solder Method :	<input type="checkbox"/> Pass	<input type="checkbox"/> NG , _____
7. Others :	<input type="checkbox"/> Pass	<input type="checkbox"/> NG , _____

>> **Go to page 2** <<

Module Number : _____		
5 · <u>Electronic Characteristics of Module :</u>		
1.Input Voltage :	<input type="checkbox"/> Pass	<input type="checkbox"/> NG , _____
2.Supply Current :	<input type="checkbox"/> Pass	<input type="checkbox"/> NG , _____
3.Driving Voltage for LCD :	<input type="checkbox"/> Pass	<input type="checkbox"/> NG , _____
4.Contrast for LCD :	<input type="checkbox"/> Pass	<input type="checkbox"/> NG , _____
5.B/L Driving Method :	<input type="checkbox"/> Pass	<input type="checkbox"/> NG , _____
6.Negative Voltage Output :	<input type="checkbox"/> Pass	<input type="checkbox"/> NG , _____
7.Interface Function :	<input type="checkbox"/> Pass	<input type="checkbox"/> NG , _____
8.LCD Uniformity :	<input type="checkbox"/> Pass	<input type="checkbox"/> NG , _____
9.ESD test :	<input type="checkbox"/> Pass	<input type="checkbox"/> NG , _____
10.Others :	<input type="checkbox"/> Pass	<input type="checkbox"/> NG , _____
6 · <u>Summary :</u>		
<div style="display: flex; justify-content: space-between; align-items: flex-end; padding: 10px;"> <div style="width: 45%;"> <p>Sales signature : _____</p> <p>Customer Signature : _____</p> </div> <div style="width: 45%; text-align: right;"> <p>Date : / / _____</p> </div> </div>		

X-ON Electronics

Largest Supplier of Electrical and Electronic Components

Click to view similar products for [LCD Graphic Display Modules & Accessories](#) category:

Click to view products by [Raystar](#) manufacturer:

Other Similar products are found below :

[NA57W001B](#) [HDM64GS12L-Y11S](#) [LCM-H12864GSFH-Y](#) [MGLS-240128-Z05](#) [GLK19264A-7T-1U-TCI-LV-E](#) [DEM 128032A](#) [FGH](#)
[RG12864F-FHW-M](#) [EGLK19264A-7T-WB-VPT-PL](#) [HG2G-V5FT22TF-W](#) [HG1G-4VT22TF-S](#) [HDM64GS24L-2-Y14S](#) [LTS-2301AP](#) [LTS-](#)
[6760P](#) [LTS-6980HR](#) [RG12864A-GHC-V](#) [RG12864A-GHY-V](#) [RG12864A-TIG-V](#) [RG12864A-TIY-V](#) [RG12864A-YHY-X](#) [RG12864B-](#)
[FHW-V](#) [RG12864B-GHW-V](#) [RG12864C-YHW-V](#) [RG12864K-BIW-VBG](#) [RG160128A-TIW-V](#) [RG240128B-YHY-M](#) [RG320240A1-BIW-V](#)
[RG320240B-BIW-V](#) [RG320240B-FHW-V](#) [DEM 097032A](#) [SGH-PY](#) [DEM 122032A](#) [SYH-LY](#) [DEM 122032C](#) [SBH-PW-N-12](#) [DEM 128064A](#)
[SBH-PW-N](#) [DEM 128064B](#) [SBH-PW-N](#) [DEM 128064F](#) [FGH-P\(RGB\)](#) [DEM 128064G](#) [FGH-PW](#) [DEM 128064I](#) [FGH-PW](#) [DEM 128064J](#)
[SBH-PW-N](#) [DEM 128064O](#) [FGH-PW](#) [DEM 128064O](#) [SBH-PW-N](#) [DEM 128064Q](#) [SBH-PW-N](#) [DEM 128128D](#) [FGH-PW](#) [DEM 240064B](#)
[FGH-PW](#) [DEM 240064B](#) [SBH-PW-N](#) [DEM 240160A](#) [SBH-PW-N](#) [DEM 320240B](#) [FGH-PW-N](#) [DEM 320240C](#) [FGH-PW](#) [EA W240-7KHLW](#)
[RX12864A1-BIW](#) [RX12864D3-BIW](#) [RX240128A-FGN](#)