



Inductors for high frequency circuits

Multilayer ceramic

MHQ-P series

MHQ1005P_{type}

MHQ1005P

1005 [0402 inch]*

* Dimensions code: JIS[EIA]

REMINDERS FOR USING THESE PRODUCTS

Before using these products, be sure to request the delivery specifications.

SAFETY REMINDERS

Please pay sufficient attention to the warnings for safe designing when using this products.

REMINDERS

- The storage period is less than 12 months. Be sure to follow the storage conditions (temperature: 5 to 40°C, humidity: 10 to 75% RH or less).
If the storage period elapses, the soldering of the terminal electrodes may deteriorate.
- Do not use or store in locations where there are conditions such as gas corrosion (salt, acid, alkali, etc.).
- Before soldering, be sure to preheat components.
The preheating temperature should be set so that the temperature difference between the solder temperature and chip temperature does not exceed 150°C.
- Soldering corrections after mounting should be within the range of the conditions determined in the specifications.
If overheated, a short circuit, performance deterioration, or lifespan shortening may occur.
- When embedding a printed circuit board where a chip is mounted to a set, be sure that residual stress is not given to the chip due to the overall distortion of the printed circuit board and partial distortion such as at screw tightening portions.
- Self heating (temperature increase) occurs when the power is turned ON, so the tolerance should be sufficient for the set thermal design.
- Carefully lay out the coil for the circuit board design of the non-magnetic shield type.
A malfunction may occur due to magnetic interference.
- Use a wrist band to discharge static electricity in your body through the grounding wire.
- Do not expose the products to magnets or magnetic fields.
- Do not use for a purpose outside of the contents regulated in the delivery specifications.
- The products listed on this catalog are intended for use in general electronic equipment (AV equipment, telecommunications equipment, home appliances, amusement equipment, computer equipment, personal equipment, office equipment, measurement equipment, industrial robots) under a normal operation and use condition.
The products are not designed or warranted to meet the requirements of the applications listed below, whose performance and/or quality require a more stringent level of safety or reliability, or whose failure, malfunction or trouble could cause serious damage to society, person or property.
If you intend to use the products in the applications listed below or if you have special requirements exceeding the range or conditions set forth in the each catalog, please contact us.

- (1) Aerospace/aviation equipment
- (2) Transportation equipment (cars, electric trains, ships, etc.)
- (3) Medical equipment
- (4) Power-generation control equipment
- (5) Atomic energy-related equipment
- (6) Seabed equipment
- (7) Transportation control equipment

- (8) Public information-processing equipment
- (9) Military equipment
- (10) Electric heating apparatus, burning equipment
- (11) Disaster prevention/crime prevention equipment
- (12) Safety equipment
- (13) Other applications that are not considered general-purpose applications

When designing your equipment even for general-purpose applications, you are kindly requested to take into consideration securing protection circuit/device or providing backup circuits in your equipment.

Inductors for high frequency circuits

Multilayer ceramic

Product compatible with RoHS directive
Halogen-free
Compatible with lead-free solders

Overview of MHQ1005P type

FEATURES

- Unique ceramic material and configuration allows for the realization of high Q characteristics that are equivalent to that of air core wound inductors.
- Multilayer method allows for a lineup with fine increments of inductance.

APPLICATION

Smart phones, tablet terminals, high frequency modules (PAs, VCOs, FEMs , etc.), Bluetooth, W-LAN, UWB, tuners and other high frequency circuits for the mobile communication industry

PART NUMBER CONSTRUCTION

MHQ	1005		P	0N7		B		T		000
Series name	LxWxH dimensions (mm)		Characteristics	Inductance (nH)		Inductance tolerance		Packaging style		Internal code
	1005	1.0x0.6x0.5	P	0N7	0.7	B	±0.1nH	T	Taping	000
				1N1	1.1	C	±0.2nH			
				11N	11	S	±0.3nH			
						G	±2%			
						H	±3%			
						J	±5%			

OPERATING TEMPERATURE RANGE, PACKAGE QUANTITY, PRODUCT WEIGHT

Type	Temperature range		Package quantity (pieces/reel)	Individual weight (mg)
	Operating temperature (°C)	Storage temperature* (°C)		
MHQ1005P	-55 to +125	-55 to +125	10000	1

* The storage temperature range is for after the circuit board is mounted.

- RoHS Directive Compliant Product: See the following for more details.<https://product.tdk.com/info/en/environment/rohs/index.html>
- Halogen-free: Indicates that Cl content is less than 900ppm, Br content is less than 900ppm, and that the total Cl and Br content is less than 1500ppm.

 Please be sure to request delivery specifications that provide further details on the features and specifications of the products for proper and safe use.
Please note that the contents may change without any prior notice due to reasons such as upgrading.

MHQ1005P type

RECOMMENDED REFLOW PROFILE

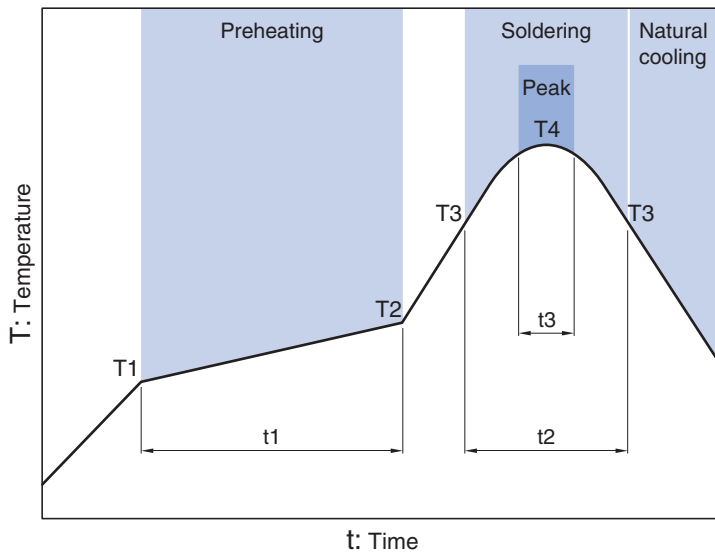

Preheating			Soldering		Peak	
Temp.		Time	Temp.	Time	Temp.	Time
T1	T2	t1	T3	t2	T4	t3
150°C	180°C	60 to 120s	230°C	30 to 60s	250 to 260°C	10s max.

MHQ1005P type

SHAPE & DIMENSIONS

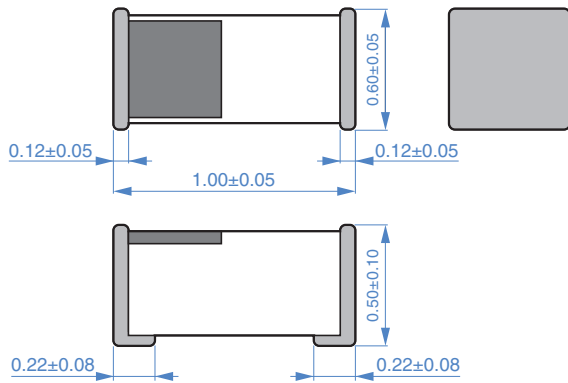

Dimensions in mm



RECOMMENDED LAND PATTERN

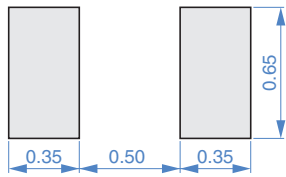

Dimensions in mm

MHQ1005P type

ELECTRICAL CHARACTERISTICS

CHARACTERISTICS SPECIFICATION TABLE

L	L measuring frequency		Q	Q measuring frequency		Self-resonant frequency		DC resistance		Rated current	Part No.
	(nH)	Tolerance		(MHz)	min.	(MHz)	(GHz)min.	(GHz)typ.	(Ω)max.		
0.7	± 0.1 nH	100	—	250	15.0	18.3	0.03	0.01	1200	MHQ1005P0N7BT000	
0.7	± 0.2 nH	100	—	250	15.0	18.3	0.03	0.01	1200	MHQ1005P0N7CT000	
0.8	± 0.1 nH	100	—	250	15.0	18.3	0.03	0.01	1200	MHQ1005P0N8BT000	
0.8	± 0.2 nH	100	—	250	15.0	18.3	0.03	0.01	1200	MHQ1005P0N8CT000	
0.9	± 0.1 nH	100	—	250	15.0	18.6	0.03	0.01	1200	MHQ1005P0N9BT000	
0.9	± 0.2 nH	100	—	250	15.0	18.6	0.03	0.01	1200	MHQ1005P0N9CT000	
1.0	± 0.1 nH	100	—	250	15.0	20.0	0.03	0.01	1200	MHQ1005P1N0BT000	
1.0	± 0.2 nH	100	—	250	15.0	20.0	0.03	0.01	1200	MHQ1005P1N0CT000	
1.0	± 0.3 nH	100	—	250	15.0	20.0	0.03	0.01	1200	MHQ1005P1N0ST000	
1.1	± 0.1 nH	100	—	250	14.0	20.0	0.03	0.02	1200	MHQ1005P1N1BT000	
1.1	± 0.2 nH	100	—	250	14.0	20.0	0.03	0.02	1200	MHQ1005P1N1CT000	
1.1	± 0.3 nH	100	—	250	14.0	20.0	0.03	0.02	1200	MHQ1005P1N1ST000	
1.2	± 0.1 nH	100	—	250	13.0	20.0	0.03	0.01	1200	MHQ1005P1N2BT000	
1.2	± 0.2 nH	100	—	250	13.0	20.0	0.03	0.01	1200	MHQ1005P1N2CT000	
1.2	± 0.3 nH	100	—	250	13.0	20.0	0.03	0.01	1200	MHQ1005P1N2ST000	
1.3	± 0.1 nH	100	—	250	12.0	20.0	0.03	0.01	1200	MHQ1005P1N3BT000	
1.3	± 0.2 nH	100	—	250	12.0	20.0	0.03	0.01	1200	MHQ1005P1N3CT000	
1.3	± 0.3 nH	100	—	250	12.0	20.0	0.03	0.01	1200	MHQ1005P1N3ST000	
1.4	± 0.1 nH	100	23	250	12.0	20.0	0.04	0.02	1000	MHQ1005P1N4BT000	
1.4	± 0.2 nH	100	23	250	12.0	20.0	0.04	0.02	1000	MHQ1005P1N4CT000	
1.4	± 0.3 nH	100	23	250	12.0	20.0	0.04	0.02	1000	MHQ1005P1N4ST000	
1.5	± 0.1 nH	100	23	250	11.0	19.7	0.04	0.02	1000	MHQ1005P1N5BT000	
1.5	± 0.2 nH	100	23	250	11.0	19.7	0.04	0.02	1000	MHQ1005P1N5CT000	
1.5	± 0.3 nH	100	23	250	11.0	19.7	0.04	0.02	1000	MHQ1005P1N5ST000	
1.6	± 0.1 nH	100	23	250	10.0	15.2	0.04	0.02	1000	MHQ1005P1N6BT000	
1.6	± 0.2 nH	100	23	250	10.0	15.2	0.04	0.02	1000	MHQ1005P1N6CT000	
1.6	± 0.3 nH	100	23	250	10.0	15.2	0.04	0.02	1000	MHQ1005P1N6ST000	
1.7	± 0.1 nH	100	23	250	10.0	15.4	0.04	0.02	1000	MHQ1005P1N7BT000	
1.7	± 0.2 nH	100	23	250	10.0	15.4	0.04	0.02	1000	MHQ1005P1N7CT000	
1.7	± 0.3 nH	100	23	250	10.0	15.4	0.04	0.02	1000	MHQ1005P1N7ST000	
1.8	± 0.1 nH	100	23	250	9.0	15.1	0.04	0.03	1000	MHQ1005P1N8BT000	
1.8	± 0.2 nH	100	23	250	9.0	15.1	0.04	0.03	1000	MHQ1005P1N8CT000	
1.8	± 0.3 nH	100	23	250	9.0	15.1	0.04	0.03	1000	MHQ1005P1N8ST000	
1.9	± 0.1 nH	100	23	250	8.0	14.8	0.05	0.03	1000	MHQ1005P1N9BT000	
1.9	± 0.2 nH	100	23	250	8.0	14.8	0.05	0.03	1000	MHQ1005P1N9CT000	
1.9	± 0.3 nH	100	23	250	8.0	14.8	0.05	0.03	1000	MHQ1005P1N9ST000	
2.0	± 0.1 nH	100	23	250	8.0	11.5	0.05	0.03	1000	MHQ1005P2N0BT000	
2.0	± 0.2 nH	100	23	250	8.0	11.5	0.05	0.03	1000	MHQ1005P2N0CT000	
2.0	± 0.3 nH	100	23	250	8.0	11.5	0.05	0.03	1000	MHQ1005P2N0ST000	
2.1	± 0.1 nH	100	23	250	8.0	13.1	0.06	0.04	1000	MHQ1005P2N1BT000	
2.1	± 0.2 nH	100	23	250	8.0	13.1	0.06	0.04	1000	MHQ1005P2N1CT000	
2.1	± 0.3 nH	100	23	250	8.0	13.1	0.06	0.04	1000	MHQ1005P2N1ST000	
2.2	± 0.1 nH	100	23	250	8.0	12.1	0.06	0.04	1000	MHQ1005P2N2BT000	
2.2	± 0.2 nH	100	23	250	8.0	12.1	0.06	0.04	1000	MHQ1005P2N2CT000	
2.2	± 0.3 nH	100	23	250	8.0	12.1	0.06	0.04	1000	MHQ1005P2N2ST000	

Short bar residual inductance =0.556nH

Measurement equipment

Measurement item	Product No.	Manufacturer
L, Q	4291B+16193A	Keysight Technologies
Self-resonant frequency	8720C	Keysight Technologies
DC resistance	Type-7561	Yokogawa

* Equivalent measurement equipment may be used.

MHQ1005P type

ELECTRICAL CHARACTERISTICS

CHARACTERISTICS SPECIFICATION TABLE

L	L measuring frequency		Q	Q measuring frequency		Self-resonant frequency		DC resistance		Rated current	Part No.
	(nH)	Tolerance		(MHz)	min.	(MHz)	(GHz)min.	(GHz)typ.	(Ω)max.		
2.3	± 0.1 nH	100	23	250	7.0	10.5	0.07	0.05	1000	MHQ1005P2N3BT000	
2.3	± 0.2 nH	100	23	250	7.0	10.5	0.07	0.05	1000	MHQ1005P2N3CT000	
2.3	± 0.3 nH	100	23	250	7.0	10.5	0.07	0.05	1000	MHQ1005P2N3ST000	
2.4	± 0.1 nH	100	23	250	6.5	9.8	0.06	0.04	1000	MHQ1005P2N4BT000	
2.4	± 0.2 nH	100	23	250	6.5	9.8	0.06	0.04	1000	MHQ1005P2N4CT000	
2.4	± 0.3 nH	100	23	250	6.5	9.8	0.06	0.04	1000	MHQ1005P2N4ST000	
2.5	± 0.1 nH	100	23	250	6.5	10.3	0.07	0.05	900	MHQ1005P2N5BT000	
2.5	± 0.2 nH	100	23	250	6.5	10.3	0.07	0.05	900	MHQ1005P2N5CT000	
2.5	± 0.3 nH	100	23	250	6.5	10.3	0.07	0.05	900	MHQ1005P2N5ST000	
2.6	± 0.1 nH	100	23	250	6.5	10.1	0.07	0.05	900	MHQ1005P2N6BT000	
2.6	± 0.2 nH	100	23	250	6.5	10.1	0.07	0.05	900	MHQ1005P2N6CT000	
2.6	± 0.3 nH	100	23	250	6.5	10.1	0.07	0.05	900	MHQ1005P2N6ST000	
2.7	± 0.1 nH	100	23	250	6.5	9.6	0.07	0.04	900	MHQ1005P2N7BT000	
2.7	± 0.2 nH	100	23	250	6.5	9.6	0.07	0.04	900	MHQ1005P2N7CT000	
2.7	± 0.3 nH	100	23	250	6.5	9.6	0.07	0.04	900	MHQ1005P2N7ST000	
2.8	± 0.1 nH	100	23	250	6.5	10.3	0.08	0.05	900	MHQ1005P2N8BT000	
2.8	± 0.2 nH	100	23	250	6.5	10.3	0.08	0.05	900	MHQ1005P2N8CT000	
2.8	± 0.3 nH	100	23	250	6.5	10.3	0.08	0.05	900	MHQ1005P2N8ST000	
2.9	± 0.1 nH	100	23	250	6.5	9.9	0.08	0.05	900	MHQ1005P2N9BT000	
2.9	± 0.2 nH	100	23	250	6.5	9.9	0.08	0.05	900	MHQ1005P2N9CT000	
2.9	± 0.3 nH	100	23	250	6.5	9.9	0.08	0.05	900	MHQ1005P2N9ST000	
3.0	± 0.1 nH	100	23	250	6.0	9.4	0.08	0.06	900	MHQ1005P3N0BT000	
3.0	± 0.2 nH	100	23	250	6.0	9.4	0.08	0.06	900	MHQ1005P3N0CT000	
3.0	± 0.3 nH	100	23	250	6.0	9.4	0.08	0.06	900	MHQ1005P3N0ST000	
3.1	± 0.1 nH	100	23	250	6.0	10.3	0.09	0.06	900	MHQ1005P3N1BT000	
3.1	± 0.2 nH	100	23	250	6.0	10.3	0.09	0.06	900	MHQ1005P3N1CT000	
3.1	± 0.3 nH	100	23	250	6.0	10.3	0.09	0.06	900	MHQ1005P3N1ST000	
3.2	± 0.1 nH	100	23	250	6.0	10.0	0.09	0.07	900	MHQ1005P3N2BT000	
3.2	± 0.2 nH	100	23	250	6.0	10.0	0.09	0.07	900	MHQ1005P3N2CT000	
3.2	± 0.3 nH	100	23	250	6.0	10.0	0.09	0.07	900	MHQ1005P3N2ST000	
3.3	± 0.1 nH	100	23	250	6.0	9.0	0.08	0.06	900	MHQ1005P3N3BT000	
3.3	± 0.2 nH	100	23	250	6.0	9.0	0.08	0.06	900	MHQ1005P3N3CT000	
3.3	± 0.3 nH	100	23	250	6.0	9.0	0.08	0.06	900	MHQ1005P3N3ST000	
3.4	± 0.1 nH	100	23	250	6.0	9.0	0.09	0.06	900	MHQ1005P3N4BT000	
3.4	± 0.2 nH	100	23	250	6.0	9.0	0.09	0.06	900	MHQ1005P3N4CT000	
3.4	± 0.3 nH	100	23	250	6.0	9.0	0.09	0.06	900	MHQ1005P3N4ST000	
3.5	± 0.1 nH	100	23	250	5.8	8.8	0.09	0.07	900	MHQ1005P3N5BT000	
3.5	± 0.2 nH	100	23	250	5.8	8.8	0.09	0.07	900	MHQ1005P3N5CT000	
3.5	± 0.3 nH	100	23	250	5.8	8.8	0.09	0.07	900	MHQ1005P3N5ST000	
3.6	± 0.1 nH	100	23	250	5.5	8.4	0.09	0.07	900	MHQ1005P3N6BT000	
3.6	± 0.2 nH	100	23	250	5.5	8.4	0.09	0.07	900	MHQ1005P3N6CT000	
3.6	± 0.3 nH	100	23	250	5.5	8.4	0.09	0.07	900	MHQ1005P3N6ST000	
3.7	± 0.1 nH	100	23	250	5.5	8.5	0.10	0.08	900	MHQ1005P3N7BT000	
3.7	± 0.2 nH	100	23	250	5.5	8.5	0.10	0.08	900	MHQ1005P3N7CT000	
3.7	± 0.3 nH	100	23	250	5.5	8.5	0.10	0.08	900	MHQ1005P3N7ST000	

· Short bar residual inductance =0.556nH

○ Measurement equipment

Measurement item	Product No.	Manufacturer
L, Q	4291B+16193A	Keysight Technologies
Self-resonant frequency	8720C	Keysight Technologies
DC resistance	Type-7561	Yokogawa

* Equivalent measurement equipment may be used.

MHQ1005P type

ELECTRICAL CHARACTERISTICS

CHARACTERISTICS SPECIFICATION TABLE

L	L measuring frequency	Q	Q measuring frequency	Self-resonant frequency		DC resistance		Rated current	Part No.	
				(nH)	Tolerance	(MHz)	min.			(MHz)
3.8	± 0.1 nH	100	23	250	5.0	7.9	0.10	0.07	900	MHQ1005P3N8BT000
3.8	± 0.2 nH	100	23	250	5.0	7.9	0.10	0.07	900	MHQ1005P3N8CT000
3.8	± 0.3 nH	100	23	250	5.0	7.9	0.10	0.07	900	MHQ1005P3N8ST000
3.9	± 0.1 nH	100	23	250	5.0	7.7	0.09	0.07	900	MHQ1005P3N9BT000
3.9	± 0.2 nH	100	23	250	5.0	7.7	0.09	0.07	900	MHQ1005P3N9CT000
3.9	± 0.3 nH	100	23	250	5.0	7.7	0.09	0.07	900	MHQ1005P3N9ST000
4.1	± 0.1 nH	100	23	250	5.0	7.7	0.10	0.07	800	MHQ1005P4N1BT000
4.1	± 0.2 nH	100	23	250	5.0	7.7	0.10	0.07	800	MHQ1005P4N1CT000
4.1	± 0.3 nH	100	23	250	5.0	7.7	0.10	0.07	800	MHQ1005P4N1ST000
4.3	± 0.1 nH	100	23	250	5.0	7.1	0.10	0.08	800	MHQ1005P4N3BT000
4.3	± 0.2 nH	100	23	250	5.0	7.1	0.10	0.08	800	MHQ1005P4N3CT000
4.3	± 0.3 nH	100	23	250	5.0	7.1	0.10	0.08	800	MHQ1005P4N3ST000
4.7	± 0.1 nH	100	23	250	5.0	7.7	0.11	0.08	800	MHQ1005P4N7BT000
4.7	± 0.2 nH	100	23	250	5.0	7.7	0.11	0.08	800	MHQ1005P4N7CT000
4.7	± 0.3 nH	100	23	250	5.0	7.7	0.11	0.08	800	MHQ1005P4N7ST000
5.1	± 0.1 nH	100	23	250	4.5	7.2	0.12	0.09	800	MHQ1005P5N1BT000
5.1	± 0.2 nH	100	23	250	4.5	7.2	0.12	0.09	800	MHQ1005P5N1CT000
5.1	± 0.3 nH	100	23	250	4.5	7.2	0.12	0.09	800	MHQ1005P5N1ST000
5.6	± 0.1 nH	100	23	250	4.5	6.5	0.13	0.10	800	MHQ1005P5N6BT000
5.6	± 0.2 nH	100	23	250	4.5	6.5	0.13	0.10	800	MHQ1005P5N6CT000
5.6	± 0.3 nH	100	23	250	4.5	6.5	0.13	0.10	800	MHQ1005P5N6ST000
5.8	± 0.1 nH	100	23	250	4.0	5.9	0.13	0.09	700	MHQ1005P5N8BT000
5.8	± 0.2 nH	100	23	250	4.0	5.9	0.13	0.09	700	MHQ1005P5N8CT000
5.8	± 0.3 nH	100	23	250	4.0	5.9	0.13	0.09	700	MHQ1005P5N8ST000
6.2	± 0.1 nH	100	23	250	4.0	5.9	0.13	0.09	700	MHQ1005P6N2BT000
6.2	± 0.2 nH	100	23	250	4.0	5.9	0.13	0.09	700	MHQ1005P6N2CT000
6.2	± 0.3 nH	100	23	250	4.0	5.9	0.13	0.09	700	MHQ1005P6N2ST000
6.8	$\pm 2\%$	100	23	250	4.0	5.8	0.14	0.10	700	MHQ1005P6N8GT000
6.8	$\pm 3\%$	100	23	250	4.0	5.8	0.14	0.10	700	MHQ1005P6N8HT000
6.8	$\pm 5\%$	100	23	250	4.0	5.8	0.14	0.10	700	MHQ1005P6N8JT000
7.3	$\pm 2\%$	100	23	250	4.0	5.7	0.17	0.13	600	MHQ1005P7N3GT000
7.3	$\pm 3\%$	100	23	250	4.0	5.7	0.17	0.13	600	MHQ1005P7N3HT000
7.3	$\pm 5\%$	100	23	250	4.0	5.7	0.17	0.13	600	MHQ1005P7N3JT000
7.5	$\pm 2\%$	100	23	250	4.0	5.6	0.16	0.12	600	MHQ1005P7N5GT000
7.5	$\pm 3\%$	100	23	250	4.0	5.6	0.16	0.12	600	MHQ1005P7N5HT000
7.5	$\pm 5\%$	100	23	250	4.0	5.6	0.16	0.12	600	MHQ1005P7N5JT000
8.2	$\pm 2\%$	100	23	250	3.6	4.9	0.16	0.12	550	MHQ1005P8N2GT000
8.2	$\pm 3\%$	100	23	250	3.6	4.9	0.16	0.12	550	MHQ1005P8N2HT000
8.2	$\pm 5\%$	100	23	250	3.6	4.9	0.16	0.12	550	MHQ1005P8N2JT000
8.7	$\pm 2\%$	100	23	250	3.5	4.7	0.17	0.13	550	MHQ1005P8N7GT000
8.7	$\pm 3\%$	100	23	250	3.5	4.7	0.17	0.13	550	MHQ1005P8N7HT000
8.7	$\pm 5\%$	100	23	250	3.5	4.7	0.17	0.13	550	MHQ1005P8N7JT000
9.1	$\pm 2\%$	100	23	250	3.4	4.5	0.17	0.13	550	MHQ1005P9N1GT000
9.1	$\pm 3\%$	100	23	250	3.4	4.5	0.17	0.13	550	MHQ1005P9N1HT000
9.1	$\pm 5\%$	100	23	250	3.4	4.5	0.17	0.13	550	MHQ1005P9N1JT000

· Short bar residual inductance =0.556nH

○ Measurement equipment

Measurement item	Product No.	Manufacturer
L, Q	4291B+16193A	Keysight Technologies
Self-resonant frequency	8720C	Keysight Technologies
DC resistance	Type-7561	Yokogawa

* Equivalent measurement equipment may be used.

MHQ1005P type

ELECTRICAL CHARACTERISTICS

CHARACTERISTICS SPECIFICATION TABLE

L	L measuring frequency		Q	Q measuring frequency		Self-resonant frequency		DC resistance		Rated current (mA)max.	Part No.
	(nH)	Tolerance		(MHz)	min.	(MHz)	(GHz)min.	(GHz)typ.	(Ω)max.		
9.5	$\pm 2\%$	100	23	250	3.3	4.7	0.21	0.16	500	MHQ1005P9N5GT000	
9.5	$\pm 3\%$	100	23	250	3.3	4.7	0.21	0.16	500	MHQ1005P9N5HT000	
9.5	$\pm 5\%$	100	23	250	3.3	4.7	0.21	0.16	500	MHQ1005P9N5JT000	
10	$\pm 2\%$	100	23	250	3.3	4.6	0.19	0.15	500	MHQ1005P10NGT000	
10	$\pm 3\%$	100	23	250	3.3	4.6	0.19	0.15	500	MHQ1005P10NHT000	
10	$\pm 5\%$	100	23	250	3.3	4.6	0.19	0.15	500	MHQ1005P10NJT000	
11	$\pm 2\%$	100	23	250	3.0	4.2	0.24	0.20	450	MHQ1005P11NGT000	
11	$\pm 3\%$	100	23	250	3.0	4.2	0.24	0.20	450	MHQ1005P11NHT000	
11	$\pm 5\%$	100	23	250	3.0	4.2	0.24	0.20	450	MHQ1005P11NJT000	
12	$\pm 2\%$	100	23	250	2.8	3.8	0.24	0.19	450	MHQ1005P12NGT000	
12	$\pm 3\%$	100	23	250	2.8	3.8	0.24	0.19	450	MHQ1005P12NHT000	
12	$\pm 5\%$	100	23	250	2.8	3.8	0.24	0.19	450	MHQ1005P12NJT000	
13	$\pm 2\%$	100	23	250	2.5	3.5	0.26	0.20	420	MHQ1005P13NGT000	
13	$\pm 3\%$	100	23	250	2.5	3.5	0.26	0.20	420	MHQ1005P13NHT000	
13	$\pm 5\%$	100	23	250	2.5	3.5	0.26	0.20	420	MHQ1005P13NJT000	
15	$\pm 2\%$	100	23	250	2.3	3.2	0.28	0.22	400	MHQ1005P15NGT000	
15	$\pm 3\%$	100	23	250	2.3	3.2	0.28	0.22	400	MHQ1005P15NHT000	
15	$\pm 5\%$	100	23	250	2.3	3.2	0.28	0.22	400	MHQ1005P15NJT000	
16	$\pm 2\%$	100	20	250	2.3	3.5	0.80	0.57	260	MHQ1005P16NGT000	
16	$\pm 3\%$	100	20	250	2.3	3.5	0.80	0.57	260	MHQ1005P16NHT000	
16	$\pm 5\%$	100	20	250	2.3	3.5	0.80	0.57	260	MHQ1005P16NJT000	
18	$\pm 2\%$	100	22	250	2.3	3.4	0.80	0.48	260	MHQ1005P18NGT000	
18	$\pm 3\%$	100	22	250	2.3	3.4	0.80	0.48	260	MHQ1005P18NHT000	
18	$\pm 5\%$	100	22	250	2.3	3.4	0.80	0.48	260	MHQ1005P18NJT000	
19	$\pm 2\%$	100	20	250	2.3	3.2	0.80	0.46	260	MHQ1005P19NGT000	
19	$\pm 3\%$	100	20	250	2.3	3.2	0.80	0.46	260	MHQ1005P19NHT000	
19	$\pm 5\%$	100	20	250	2.3	3.2	0.80	0.46	260	MHQ1005P19NJT000	
20	$\pm 2\%$	100	20	250	2.1	3.1	1.10	0.46	260	MHQ1005P20NGT000	
20	$\pm 3\%$	100	20	250	2.1	3.1	1.10	0.46	260	MHQ1005P20NHT000	
20	$\pm 5\%$	100	20	250	2.1	3.1	1.10	0.46	260	MHQ1005P20NJT000	
22	$\pm 2\%$	100	20	250	2.1	2.9	1.10	0.66	230	MHQ1005P22NGT000	
22	$\pm 3\%$	100	20	250	2.1	2.9	1.10	0.66	230	MHQ1005P22NHT000	
22	$\pm 5\%$	100	20	250	2.1	2.9	1.10	0.66	230	MHQ1005P22NJT000	
23	$\pm 2\%$	100	22	250	2.0	2.9	1.10	0.62	230	MHQ1005P23NGT000	
23	$\pm 3\%$	100	22	250	2.0	2.9	1.10	0.62	230	MHQ1005P23NHT000	
23	$\pm 5\%$	100	22	250	2.0	2.9	1.10	0.62	230	MHQ1005P23NJT000	
24	$\pm 2\%$	100	20	250	2.0	2.8	1.20	0.55	230	MHQ1005P24NGT000	
24	$\pm 3\%$	100	20	250	2.0	2.8	1.20	0.55	230	MHQ1005P24NHT000	
24	$\pm 5\%$	100	20	250	2.0	2.8	1.20	0.55	230	MHQ1005P24NJT000	
27	$\pm 2\%$	100	20	250	1.7	2.6	1.30	0.66	230	MHQ1005P27NGT000	
27	$\pm 3\%$	100	20	250	1.7	2.6	1.30	0.66	230	MHQ1005P27NHT000	
27	$\pm 5\%$	100	20	250	1.7	2.6	1.30	0.66	230	MHQ1005P27NJT000	
30	$\pm 2\%$	100	20	250	1.7	2.4	1.30	0.80	220	MHQ1005P30NGT000	
30	$\pm 3\%$	100	20	250	1.7	2.4	1.30	0.80	220	MHQ1005P30NHT000	
30	$\pm 5\%$	100	20	250	1.7	2.4	1.30	0.80	220	MHQ1005P30NJT000	

· Short bar residual inductance =0.556nH

○ Measurement equipment

Measurement item	Product No.	Manufacturer
L, Q	4291B+16193A	Keysight Technologies
Self-resonant frequency	8720C	Keysight Technologies
DC resistance	Type-7561	Yokogawa

* Equivalent measurement equipment may be used.

MHQ1005P type

ELECTRICAL CHARACTERISTICS

CHARACTERISTICS SPECIFICATION TABLE

L	L measuring frequency		Q	Q measuring frequency		Self-resonant frequency		DC resistance		Rated current	Part No.
	(nH)	Tolerance		(MHz)	min.	(MHz)	(GHz)min.	(GHz)typ.	(Ω)max.		
33	$\pm 2\%$	100	20	250	1.6	2.3	1.50	0.74	220	MHQ1005P33NGT000	
33	$\pm 3\%$	100	20	250	1.6	2.3	1.50	0.74	220	MHQ1005P33NHT000	
33	$\pm 5\%$	100	20	250	1.6	2.3	1.50	0.74	220	MHQ1005P33NJT000	
36	$\pm 2\%$	100	20	250	1.6	2.2	1.50	0.92	190	MHQ1005P36NGT000	
36	$\pm 3\%$	100	20	250	1.6	2.2	1.50	0.92	190	MHQ1005P36NHT000	
36	$\pm 5\%$	100	20	250	1.6	2.2	1.50	0.92	190	MHQ1005P36NJT000	
39	$\pm 2\%$	100	20	250	1.4	2.1	1.50	0.95	190	MHQ1005P39NGT000	
39	$\pm 3\%$	100	20	250	1.4	2.1	1.50	0.95	190	MHQ1005P39NHT000	
39	$\pm 5\%$	100	20	250	1.4	2.1	1.50	0.95	190	MHQ1005P39NJT000	
40	$\pm 2\%$	100	20	250	1.4	2.1	1.50	1.12	190	MHQ1005P40NGT000	
40	$\pm 3\%$	100	20	250	1.4	2.1	1.50	1.12	190	MHQ1005P40NHT000	
40	$\pm 5\%$	100	20	250	1.4	2.1	1.50	1.12	190	MHQ1005P40NJT000	
43	$\pm 2\%$	100	22	250	1.4	2.0	1.60	1.06	190	MHQ1005P43NGT000	
43	$\pm 3\%$	100	22	250	1.4	2.0	1.60	1.06	190	MHQ1005P43NHT000	
43	$\pm 5\%$	100	22	250	1.4	2.0	1.60	1.06	190	MHQ1005P43NJT000	
47	$\pm 2\%$	100	22	250	1.3	1.9	1.60	1.09	190	MHQ1005P47NGT000	
47	$\pm 3\%$	100	22	250	1.3	1.9	1.60	1.09	190	MHQ1005P47NHT000	
47	$\pm 5\%$	100	22	250	1.3	1.9	1.60	1.09	190	MHQ1005P47NJT000	
51	$\pm 2\%$	100	22	250	1.3	1.8	1.80	1.17	190	MHQ1005P51NGT000	
51	$\pm 3\%$	100	22	250	1.3	1.8	1.80	1.17	190	MHQ1005P51NHT000	
51	$\pm 5\%$	100	22	250	1.3	1.8	1.80	1.17	190	MHQ1005P51NJT000	
56	$\pm 2\%$	100	22	250	1.2	1.8	1.80	1.22	180	MHQ1005P56NGT000	
56	$\pm 3\%$	100	22	250	1.2	1.8	1.80	1.22	180	MHQ1005P56NHT000	
56	$\pm 5\%$	100	22	250	1.2	1.8	1.80	1.22	180	MHQ1005P56NJT000	
62	$\pm 2\%$	100	22	250	1.1	1.6	1.90	1.36	180	MHQ1005P62NGT000	
62	$\pm 3\%$	100	22	250	1.1	1.6	1.90	1.36	180	MHQ1005P62NHT000	
62	$\pm 5\%$	100	22	250	1.1	1.6	1.90	1.36	180	MHQ1005P62NJT000	
68	$\pm 2\%$	100	22	250	1.1	1.6	2.00	1.43	160	MHQ1005P68NGT000	
68	$\pm 3\%$	100	22	250	1.1	1.6	2.00	1.43	160	MHQ1005P68NHT000	
68	$\pm 5\%$	100	22	250	1.1	1.6	2.00	1.43	160	MHQ1005P68NJT000	
72	$\pm 2\%$	100	22	250	1.1	1.5	2.20	1.62	160	MHQ1005P72NGT000	
72	$\pm 3\%$	100	22	250	1.1	1.5	2.20	1.62	160	MHQ1005P72NHT000	
72	$\pm 5\%$	100	22	250	1.1	1.5	2.20	1.62	160	MHQ1005P72NJT000	
75	$\pm 2\%$	100	22	250	1.1	1.5	2.20	1.53	160	MHQ1005P75NGT000	
75	$\pm 3\%$	100	22	250	1.1	1.5	2.20	1.53	160	MHQ1005P75NHT000	
75	$\pm 5\%$	100	22	250	1.1	1.5	2.20	1.53	160	MHQ1005P75NJT000	
82	$\pm 2\%$	100	22	250	0.9	1.5	2.30	1.61	160	MHQ1005P82NGT000	
82	$\pm 3\%$	100	22	250	0.9	1.5	2.30	1.61	160	MHQ1005P82NHT000	
82	$\pm 5\%$	100	22	250	0.9	1.5	2.30	1.61	160	MHQ1005P82NJT000	
91	$\pm 2\%$	100	23	250	0.9	1.4	2.30	1.78	160	MHQ1005P91NGT000	
91	$\pm 3\%$	100	23	250	0.9	1.4	2.30	1.78	160	MHQ1005P91NHT000	
91	$\pm 5\%$	100	23	250	0.9	1.4	2.30	1.78	160	MHQ1005P91NJT000	
100	$\pm 2\%$	100	23	250	0.9	1.2	2.50	1.80	150	MHQ1005PR10GT000	
100	$\pm 3\%$	100	23	250	0.9	1.2	2.50	1.80	150	MHQ1005PR10HT000	
100	$\pm 5\%$	100	23	250	0.9	1.2	2.50	1.80	150	MHQ1005PR10JT000	

· Short bar residual inductance =0.556nH

○ Measurement equipment

Measurement item	Product No.	Manufacturer
L, Q	4291B+16193A	Keysight Technologies
Self-resonant frequency	8720C	Keysight Technologies
DC resistance	Type-7561	Yokogawa

* Equivalent measurement equipment may be used.

MHQ1005P type

ELECTRICAL CHARACTERISTICS

CHARACTERISTICS SPECIFICATION TABLE

L	L measuring frequency		Q	Q measuring frequency		Self-resonant frequency		DC resistance		Rated current (mA)max.	Part No.
	(nH)	Tolerance		(MHz)	min.	(MHz)	(GHz)min.	(GHz)typ.	(Ω)max.		
110	$\pm 2\%$	100	22	250	0.8	1.2	2.70	1.98	150	MHQ1005PR11GT000	
110	$\pm 3\%$	100	22	250	0.8	1.2	2.70	1.98	150	MHQ1005PR11HT000	
110	$\pm 5\%$	100	22	250	0.8	1.2	2.70	1.98	150	MHQ1005PR11JT000	
120	$\pm 2\%$	100	22	250	0.8	1.2	2.70	1.81	140	MHQ1005PR12GT000	
120	$\pm 3\%$	100	22	250	0.8	1.2	2.70	1.81	140	MHQ1005PR12HT000	
120	$\pm 5\%$	100	22	250	0.8	1.2	2.70	1.81	140	MHQ1005PR12JT000	
130	$\pm 2\%$	100	22	250	0.8	1.1	2.90	2.18	110	MHQ1005PR13GT000	
130	$\pm 3\%$	100	22	250	0.8	1.1	2.90	2.18	110	MHQ1005PR13HT000	
130	$\pm 5\%$	100	22	250	0.8	1.1	2.90	2.18	110	MHQ1005PR13JT000	
150	$\pm 2\%$	100	22	250	0.8	1.0	3.00	2.03	110	MHQ1005PR15GT000	
150	$\pm 3\%$	100	22	250	0.8	1.0	3.00	2.03	110	MHQ1005PR15HT000	
150	$\pm 5\%$	100	22	250	0.8	1.0	3.00	2.03	110	MHQ1005PR15JT000	
160	$\pm 2\%$	100	22	250	0.7	1.0	5.80	4.79	90	MHQ1005PR16GT000	
160	$\pm 3\%$	100	22	250	0.7	1.0	5.80	4.79	90	MHQ1005PR16HT000	
160	$\pm 5\%$	100	22	250	0.7	1.0	5.80	4.79	90	MHQ1005PR16JT000	
180	$\pm 2\%$	100	18	250	0.6	0.9	6.00	4.86	90	MHQ1005PR18GT000	
180	$\pm 3\%$	100	18	250	0.6	0.9	6.00	4.86	90	MHQ1005PR18HT000	
180	$\pm 5\%$	100	18	250	0.6	0.9	6.00	4.86	90	MHQ1005PR18JT000	
200	$\pm 2\%$	100	18	250	0.6	0.9	6.20	5.06	80	MHQ1005PR20GT000	
200	$\pm 3\%$	100	18	250	0.6	0.9	6.20	5.06	80	MHQ1005PR20HT000	
200	$\pm 5\%$	100	18	250	0.6	0.9	6.20	5.06	80	MHQ1005PR20JT000	
220	$\pm 2\%$	100	18	250	0.6	0.8	6.60	5.38	80	MHQ1005PR22GT000	
220	$\pm 3\%$	100	18	250	0.6	0.8	6.60	5.38	80	MHQ1005PR22HT000	
220	$\pm 5\%$	100	18	250	0.6	0.8	6.60	5.38	80	MHQ1005PR22JT000	
240	$\pm 2\%$	100	18	250	0.6	0.9	6.80	5.58	80	MHQ1005PR24GT000	
240	$\pm 3\%$	100	18	250	0.6	0.9	6.80	5.58	80	MHQ1005PR24HT000	
240	$\pm 5\%$	100	18	250	0.6	0.9	6.80	5.58	80	MHQ1005PR24JT000	
270	$\pm 2\%$	100	18	250	0.6	0.9	7.00	5.74	80	MHQ1005PR27GT000	
270	$\pm 3\%$	100	18	250	0.6	0.9	7.00	5.74	80	MHQ1005PR27HT000	
270	$\pm 5\%$	100	18	250	0.6	0.9	7.00	5.74	80	MHQ1005PR27JT000	
300	$\pm 2\%$	50	13	100	0.48	0.7	7.80	6.38	80	MHQ1005PR30GT000	
300	$\pm 3\%$	50	13	100	0.48	0.7	7.80	6.38	80	MHQ1005PR30HT000	
300	$\pm 5\%$	50	13	100	0.48	0.7	7.80	6.38	80	MHQ1005PR30JT000	
330	$\pm 2\%$	50	13	100	0.48	0.67	8.20	6.64	80	MHQ1005PR33GT000	
330	$\pm 3\%$	50	13	100	0.48	0.67	8.20	6.64	80	MHQ1005PR33HT000	
330	$\pm 5\%$	50	13	100	0.48	0.67	8.20	6.64	80	MHQ1005PR33JT000	
360	$\pm 2\%$	50	13	100	0.45	0.65	8.40	6.91	80	MHQ1005PR36GT000	
360	$\pm 3\%$	50	13	100	0.45	0.65	8.40	6.91	80	MHQ1005PR36HT000	
360	$\pm 5\%$	50	13	100	0.45	0.65	8.40	6.91	80	MHQ1005PR36JT000	
390	$\pm 2\%$	50	13	100	0.45	0.64	8.80	7.20	70	MHQ1005PR39GT000	
390	$\pm 3\%$	50	13	100	0.45	0.64	8.80	7.20	70	MHQ1005PR39HT000	
390	$\pm 5\%$	50	13	100	0.45	0.64	8.80	7.20	70	MHQ1005PR39JT000	
430	$\pm 2\%$	50	13	100	0.38	0.56	9.60	7.88	70	MHQ1005PR43GT000	
430	$\pm 3\%$	50	13	100	0.38	0.56	9.60	7.88	70	MHQ1005PR43HT000	
430	$\pm 5\%$	50	13	100	0.38	0.56	9.60	7.88	70	MHQ1005PR43JT000	
470	$\pm 2\%$	50	13	100	0.38	0.59	9.60	7.90	70	MHQ1005PR47GT000	
470	$\pm 3\%$	50	13	100	0.38	0.59	9.60	7.90	70	MHQ1005PR47HT000	
470	$\pm 5\%$	50	13	100	0.38	0.59	9.60	7.90	70	MHQ1005PR47JT000	
510	$\pm 2\%$	50	13	100	0.36	0.52	10.2	8.44	70	MHQ1005PR51GT000	
510	$\pm 3\%$	50	13	100	0.36	0.52	10.2	8.44	70	MHQ1005PR51HT000	
510	$\pm 5\%$	50	13	100	0.36	0.52	10.2	8.44	70	MHQ1005PR51JT000	
560	$\pm 2\%$	50	13	100	0.36	0.51	10.6	8.78	70	MHQ1005PR56GT000	
560	$\pm 3\%$	50	13	100	0.36	0.51	10.6	8.78	70	MHQ1005PR56HT000	
560	$\pm 5\%$	50	13	100	0.36	0.51	10.6	8.78	70	MHQ1005PR56JT000	

· Short bar residual inductance =0.556nH

Measurement equipment

Measurement item	Product No.	Manufacturer
L, Q	4291B+16193A	Keysight Technologies
Self-resonant frequency	8720C	Keysight Technologies
DC resistance	Type-7561	Yokogawa

* Equivalent measurement equipment may be used.

⚠ Please be sure to request delivery specifications that provide further details on the features and specifications of the products for proper and safe use.
Please note that the contents may change without any prior notice due to reasons such as upgrading.

MHQ1005P type

ELECTRICAL CHARACTERISTICS

L, Q FREQUENCY CHARACTERISTICS TABLE

L(nH)typ.					Q typ.					Part No.
500MHz	800MHz	1.8GHz	2.0GHz	2.4GHz	500MHz	800MHz	1.8GHz	2.0GHz	2.4GHz	
0.7	0.7	0.7	0.7	0.7	71min.	90min.	139min.	148min.	177min.	MHQ1005P0N7BT000
0.7	0.7	0.7	0.7	0.7	71min.	90min.	139min.	148min.	177min.	MHQ1005P0N7CT000
0.8	0.8	0.8	0.8	0.8	71min.	90min.	139min.	148min.	177min.	MHQ1005P0N8BT000
0.8	0.8	0.8	0.8	0.8	71min.	90min.	139min.	148min.	177min.	MHQ1005P0N8CT000
0.9	0.9	0.9	0.9	0.9	71min.	90min.	139min.	148min.	177min.	MHQ1005P0N9BT000
0.9	0.9	0.9	0.9	0.9	71min.	90min.	139min.	148min.	177min.	MHQ1005P0N9CT000
1.0	1.0	1.0	1.0	1.0	71min.	90min.	139min.	148min.	177min.	MHQ1005P1N0BT000
1.0	1.0	1.0	1.0	1.0	71min.	90min.	139min.	148min.	177min.	MHQ1005P1N0CT000
1.0	1.0	1.0	1.0	1.0	71min.	90min.	139min.	148min.	177min.	MHQ1005P1N0ST000
1.1	1.1	1.1	1.1	1.1	71min.	90min.	139min.	148min.	177min.	MHQ1005P1N1BT000
1.1	1.1	1.1	1.1	1.1	71min.	90min.	139min.	148min.	177min.	MHQ1005P1N1CT000
1.1	1.1	1.1	1.1	1.1	71min.	90min.	139min.	148min.	177min.	MHQ1005P1N1ST000
1.2	1.2	1.2	1.2	1.2	71min.	90min.	139min.	148min.	177min.	MHQ1005P1N2BT000
1.2	1.2	1.2	1.2	1.2	71min.	90min.	139min.	148min.	177min.	MHQ1005P1N2CT000
1.2	1.2	1.2	1.2	1.2	71min.	90min.	139min.	148min.	177min.	MHQ1005P1N2ST000
1.3	1.3	1.3	1.3	1.3	71	90	139	148	178	MHQ1005P1N3BT000
1.3	1.3	1.3	1.3	1.3	71	90	139	148	178	MHQ1005P1N3CT000
1.3	1.3	1.3	1.3	1.3	71	90	139	148	178	MHQ1005P1N3ST000
1.4	1.4	1.4	1.4	1.4	88	103	173	178	203	MHQ1005P1N4BT000
1.4	1.4	1.4	1.4	1.4	88	103	173	178	203	MHQ1005P1N4CT000
1.4	1.4	1.4	1.4	1.4	88	103	173	178	203	MHQ1005P1N4ST000
1.5	1.5	1.5	1.5	1.5	66	76	124	133	151	MHQ1005P1N5BT000
1.5	1.5	1.5	1.5	1.5	66	76	124	133	151	MHQ1005P1N5CT000
1.5	1.5	1.5	1.5	1.5	66	76	124	133	151	MHQ1005P1N5ST000
1.6	1.6	1.6	1.6	1.6	70	88	147	151	171	MHQ1005P1N6BT000
1.6	1.6	1.6	1.6	1.6	70	88	147	151	171	MHQ1005P1N6CT000
1.6	1.6	1.6	1.6	1.6	70	88	147	151	171	MHQ1005P1N6ST000
1.7	1.7	1.7	1.7	1.7	63	80	140	151	179	MHQ1005P1N7BT000
1.7	1.7	1.7	1.7	1.7	63	80	140	151	179	MHQ1005P1N7CT000
1.7	1.7	1.7	1.7	1.7	63	80	140	151	179	MHQ1005P1N7ST000
1.8	1.8	1.8	1.8	1.8	60	75	125	130	150	MHQ1005P1N8BT000
1.8	1.8	1.8	1.8	1.8	60	75	125	130	150	MHQ1005P1N8CT000
1.8	1.8	1.8	1.8	1.8	60	75	125	130	150	MHQ1005P1N8ST000
1.9	1.9	1.9	1.9	1.9	53	68	119	126	150	MHQ1005P1N9BT000
1.9	1.9	1.9	1.9	1.9	53	68	119	126	150	MHQ1005P1N9CT000
1.9	1.9	1.9	1.9	1.9	53	68	119	126	150	MHQ1005P1N9ST000
2.0	2.0	2.0	2.0	2.0	60	74	122	129	146	MHQ1005P2N0BT000
2.0	2.0	2.0	2.0	2.0	60	74	122	129	146	MHQ1005P2N0CT000
2.0	2.0	2.0	2.0	2.0	60	74	122	129	146	MHQ1005P2N0ST000
2.1	2.1	2.1	2.1	2.1	54	70	121	129	152	MHQ1005P2N1BT000
2.1	2.1	2.1	2.1	2.1	54	70	121	129	152	MHQ1005P2N1CT000
2.1	2.1	2.1	2.1	2.1	54	70	121	129	152	MHQ1005P2N1ST000
2.2	2.2	2.2	2.2	2.2	54	68	108	116	131	MHQ1005P2N2BT000
2.2	2.2	2.2	2.2	2.2	54	68	108	116	131	MHQ1005P2N2CT000
2.2	2.2	2.2	2.2	2.2	54	68	108	116	131	MHQ1005P2N2ST000

○ Measurement equipment

Product No.	Manufacturer
4291B+16193A	Keysight Technologies

* Equivalent measurement equipment may be used.

MHQ1005P type

ELECTRICAL CHARACTERISTICS

L, Q FREQUENCY CHARACTERISTICS TABLE

L(nH)typ.					Q typ.					Part No.
500MHz	800MHz	1.8GHz	2.0GHz	2.4GHz	500MHz	800MHz	1.8GHz	2.0GHz	2.4GHz	
2.3	2.3	2.3	2.3	2.3	50	64	101	106	119	MHQ1005P2N3BT000
2.3	2.3	2.3	2.3	2.3	50	64	101	106	119	MHQ1005P2N3CT000
2.3	2.3	2.3	2.3	2.3	50	64	101	106	119	MHQ1005P2N3ST000
2.4	2.3	2.4	2.4	2.4	50	64	105	110	125	MHQ1005P2N4BT000
2.4	2.3	2.4	2.4	2.4	50	64	105	110	125	MHQ1005P2N4CT000
2.4	2.3	2.4	2.4	2.4	50	64	105	110	125	MHQ1005P2N4ST000
2.5	2.5	2.5	2.5	2.6	50	65	110	114	135	MHQ1005P2N5BT000
2.5	2.5	2.5	2.5	2.6	50	65	110	114	135	MHQ1005P2N5CT000
2.5	2.5	2.5	2.5	2.6	50	65	110	114	135	MHQ1005P2N5ST000
2.5	2.5	2.6	2.6	2.7	48	65	103	107	122	MHQ1005P2N6BT000
2.5	2.5	2.6	2.6	2.7	48	65	103	107	122	MHQ1005P2N6CT000
2.5	2.5	2.6	2.6	2.7	48	65	103	107	122	MHQ1005P2N6ST000
2.6	2.6	2.7	2.7	2.8	49	61	98	102	116	MHQ1005P2N7BT000
2.6	2.6	2.7	2.7	2.8	49	61	98	102	116	MHQ1005P2N7CT000
2.6	2.6	2.7	2.7	2.8	49	61	98	102	116	MHQ1005P2N7ST000
2.7	2.7	2.8	2.8	2.9	46	58	100	105	123	MHQ1005P2N8BT000
2.7	2.7	2.8	2.8	2.9	46	58	100	105	123	MHQ1005P2N8CT000
2.7	2.7	2.8	2.8	2.9	46	58	100	105	123	MHQ1005P2N8ST000
2.8	2.8	2.9	2.9	3.0	45	58	99	103	120	MHQ1005P2N9BT000
2.8	2.8	2.9	2.9	3.0	45	58	99	103	120	MHQ1005P2N9CT000
2.8	2.8	2.9	2.9	3.0	45	58	99	103	120	MHQ1005P2N9ST000
2.9	2.9	3.0	3.0	3.1	49	62	102	106	120	MHQ1005P3N0BT000
2.9	2.9	3.0	3.0	3.1	49	62	102	106	120	MHQ1005P3N0CT000
2.9	2.9	3.0	3.0	3.1	49	62	102	106	120	MHQ1005P3N0ST000
3.0	3.0	3.1	3.1	3.2	45	58	99	104	121	MHQ1005P3N1BT000
3.0	3.0	3.1	3.1	3.2	45	58	99	104	121	MHQ1005P3N1CT000
3.0	3.0	3.1	3.1	3.2	45	58	99	104	121	MHQ1005P3N1ST000
3.1	3.1	3.2	3.2	3.3	45	58	99	106	121	MHQ1005P3N2BT000
3.1	3.1	3.2	3.2	3.3	45	58	99	106	121	MHQ1005P3N2CT000
3.1	3.1	3.2	3.2	3.3	45	58	99	106	121	MHQ1005P3N2ST000
3.2	3.2	3.3	3.4	3.4	48	60	96	101	115	MHQ1005P3N3BT000
3.2	3.2	3.3	3.4	3.4	48	60	96	101	115	MHQ1005P3N3CT000
3.2	3.2	3.3	3.4	3.4	48	60	96	101	115	MHQ1005P3N3ST000
3.3	3.3	3.4	3.5	3.5	45	57	96	102	118	MHQ1005P3N4BT000
3.3	3.3	3.4	3.5	3.5	45	57	96	102	118	MHQ1005P3N4CT000
3.3	3.3	3.4	3.5	3.5	45	57	96	102	118	MHQ1005P3N4ST000
3.4	3.4	3.5	3.6	3.6	43	57	89	92	104	MHQ1005P3N5BT000
3.4	3.4	3.5	3.6	3.6	43	57	89	92	104	MHQ1005P3N5CT000
3.4	3.4	3.5	3.6	3.6	43	57	89	92	104	MHQ1005P3N5ST000
3.5	3.5	3.6	3.6	3.7	43	56	91	96	110	MHQ1005P3N6BT000
3.5	3.5	3.6	3.6	3.7	43	56	91	96	110	MHQ1005P3N6CT000
3.5	3.5	3.6	3.6	3.7	43	56	91	96	110	MHQ1005P3N6ST000
3.6	3.6	3.7	3.8	3.9	46	57	96	100	114	MHQ1005P3N7BT000
3.6	3.6	3.7	3.8	3.9	46	57	96	100	114	MHQ1005P3N7CT000
3.6	3.6	3.7	3.8	3.9	46	57	96	100	114	MHQ1005P3N7ST000
3.7	3.7	3.9	3.9	4.0	45	59	93	96	109	MHQ1005P3N8BT000
3.7	3.7	3.9	3.9	4.0	45	59	93	96	109	MHQ1005P3N8CT000
3.7	3.7	3.9	3.9	4.0	45	59	93	96	109	MHQ1005P3N8ST000

○ Measurement equipment

Product No.	Manufacturer
4291B+16193A	Keysight Technologies

* Equivalent measurement equipment may be used.

MHQ1005P type

ELECTRICAL CHARACTERISTICS

L, Q FREQUENCY CHARACTERISTICS TABLE

L(nH)typ.					Q typ.					Part No.
500MHz	800MHz	1.8GHz	2.0GHz	2.4GHz	500MHz	800MHz	1.8GHz	2.0GHz	2.4GHz	
3.8	3.8	4.0	4.0	4.1	48	61	96	99	111	MHQ1005P3N9BT000
3.8	3.8	4.0	4.0	4.1	48	61	96	99	111	MHQ1005P3N9CT000
3.8	3.8	4.0	4.0	4.1	48	61	96	99	111	MHQ1005P3N9ST000
4.0	4.0	4.2	4.3	4.4	46	59	98	101	115	MHQ1005P4N1BT000
4.0	4.0	4.2	4.3	4.4	46	59	98	101	115	MHQ1005P4N1CT000
4.0	4.0	4.2	4.3	4.4	46	59	98	101	115	MHQ1005P4N1ST000
4.2	4.2	4.4	4.5	4.6	47	60	95	97	107	MHQ1005P4N3BT000
4.2	4.2	4.4	4.5	4.6	47	60	95	97	107	MHQ1005P4N3CT000
4.2	4.2	4.4	4.5	4.6	47	60	95	97	107	MHQ1005P4N3ST000
4.6	4.6	4.8	4.9	5.0	44	56	89	93	102	MHQ1005P4N7BT000
4.6	4.6	4.8	4.9	5.0	44	56	89	93	102	MHQ1005P4N7CT000
4.6	4.6	4.8	4.9	5.0	44	56	89	93	102	MHQ1005P4N7ST000
5.0	5.0	5.2	5.3	5.5	43	55	86	90	99	MHQ1005P5N1BT000
5.0	5.0	5.2	5.3	5.5	43	55	86	90	99	MHQ1005P5N1CT000
5.0	5.0	5.2	5.3	5.5	43	55	86	90	99	MHQ1005P5N1ST000
5.5	5.5	5.8	5.9	6.1	43	54	84	87	94	MHQ1005P5N6BT000
5.5	5.5	5.8	5.9	6.1	43	54	84	87	94	MHQ1005P5N6CT000
5.5	5.5	5.8	5.9	6.1	43	54	84	87	94	MHQ1005P5N6ST000
5.7	5.7	6.1	6.2	6.5	43	57	84	87	94	MHQ1005P5N8BT000
5.7	5.7	6.1	6.2	6.5	43	57	84	87	94	MHQ1005P5N8CT000
5.7	5.7	6.1	6.2	6.5	43	57	84	87	94	MHQ1005P5N8ST000
6.1	6.1	6.6	6.7	7.0	45	57	85	87	93	MHQ1005P6N2BT000
6.1	6.1	6.6	6.7	7.0	45	57	85	87	93	MHQ1005P6N2CT000
6.1	6.1	6.6	6.7	7.0	45	57	85	87	93	MHQ1005P6N2ST000
6.7	6.7	7.3	7.5	7.9	45	58	85	88	92	MHQ1005P6N8GT000
6.7	6.7	7.3	7.5	7.9	45	58	85	88	92	MHQ1005P6N8HT000
6.7	6.7	7.3	7.5	7.9	45	58	85	88	92	MHQ1005P6N8JT000
7.1	7.2	7.7	7.9	8.3	40	52	77	80	84	MHQ1005P7N3GT000
7.1	7.2	7.7	7.9	8.3	40	52	77	80	84	MHQ1005P7N3HT000
7.1	7.2	7.7	7.9	8.3	40	52	77	80	84	MHQ1005P7N3JT000
7.3	7.4	7.9	8.1	8.5	42	54	80	83	88	MHQ1005P7N5GT000
7.3	7.4	7.9	8.1	8.5	42	54	80	83	88	MHQ1005P7N5HT000
7.3	7.4	7.9	8.1	8.5	42	54	80	83	88	MHQ1005P7N5JT000
8.0	8.1	9.0	9.4	10.0	44	56	80	81	82	MHQ1005P8N2GT000
8.0	8.1	9.0	9.4	10.0	44	56	80	81	82	MHQ1005P8N2HT000
8.0	8.1	9.0	9.4	10.0	44	56	80	81	82	MHQ1005P8N2JT000
8.5	8.6	9.6	10.0	10.8	42	52	78	79	80	MHQ1005P8N7GT000
8.5	8.6	9.6	10.0	10.8	42	52	78	79	80	MHQ1005P8N7HT000
8.5	8.6	9.6	10.0	10.8	42	52	78	79	80	MHQ1005P8N7JT000
8.9	9.1	10.1	10.5	11.3	43	54	77	78	79	MHQ1005P9N1GT000
8.9	9.1	10.1	10.5	11.3	43	54	77	78	79	MHQ1005P9N1HT000
8.9	9.1	10.1	10.5	11.3	43	54	77	78	79	MHQ1005P9N1JT000

○ Measurement equipment

Product No.	Manufacturer
4291B+16193A	Keysight Technologies

* Equivalent measurement equipment may be used.

MHQ1005P type

ELECTRICAL CHARACTERISTICS

L, Q FREQUENCY CHARACTERISTICS TABLE

L(nH)typ.					Q typ.					Part No.
500MHz	800MHz	1.8GHz	2.0GHz	2.4GHz	500MHz	800MHz	1.8GHz	2.0GHz	2.4GHz	
9.3	9.4	10.6	11.1	12.0	42	54	75	75	75	MHQ1005P9N5GT000
9.3	9.4	10.6	11.1	12.0	42	54	75	75	75	MHQ1005P9N5HT000
9.3	9.4	10.6	11.1	12.0	42	54	75	75	75	MHQ1005P9N5JT000
10	10	11	12	13	42	54	73	74	74	MHQ1005P10NGT000
10	10	11	12	13	42	54	73	74	74	MHQ1005P10NHT000
10	10	11	12	13	42	54	73	74	74	MHQ1005P10NJT000
11	11	13	13	14	41	52	70	70	69	MHQ1005P11NGT000
11	11	13	13	14	41	52	70	70	69	MHQ1005P11NHT000
11	11	13	13	14	41	52	70	70	69	MHQ1005P11NJT000
12	12	14	15	17	40	50	66	65	61	MHQ1005P12NGT000
12	12	14	15	17	40	50	66	65	61	MHQ1005P12NHT000
12	12	14	15	17	40	50	66	65	61	MHQ1005P12NJT000
13	13	16	17	19	42	53	66	66	61	MHQ1005P13NGT000
13	13	16	17	19	42	53	66	66	61	MHQ1005P13NHT000
13	13	16	17	19	42	53	66	66	61	MHQ1005P13NJT000
15	15	19	21	26	39	48	57	54	46	MHQ1005P15NGT000
15	15	19	21	26	39	48	57	54	46	MHQ1005P15NHT000
15	15	19	21	26	39	48	57	54	46	MHQ1005P15NJT000
16	16	20	21	25	34	43	54	52	49	MHQ1005P16NGT000
16	16	20	21	25	34	43	54	52	49	MHQ1005P16NHT000
16	16	20	21	25	34	43	54	52	49	MHQ1005P16NJT000
18	18	23	25	30	39	49	60	57	51	MHQ1005P18NGT000
18	18	23	25	30	39	49	60	57	51	MHQ1005P18NHT000
18	18	23	25	30	39	49	60	57	51	MHQ1005P18NJT000
19	19	25	28	35	39	49	59	55	46	MHQ1005P19NGT000
19	19	25	28	35	39	49	59	55	46	MHQ1005P19NHT000
19	19	25	28	35	39	49	59	55	46	MHQ1005P19NJT000
20	20	26	29	35	38	47	56	53	43	MHQ1005P20NGT000
20	20	26	29	35	38	47	56	53	43	MHQ1005P20NHT000
20	20	26	29	35	38	47	56	53	43	MHQ1005P20NJT000
22	23	31	35	—	34	42	47	43	—	MHQ1005P22NGT000
22	23	31	35	—	34	42	47	43	—	MHQ1005P22NHT000
22	23	31	35	—	34	42	47	43	—	MHQ1005P22NJT000
23	24	33	37	—	41	50	53	48	—	MHQ1005P23NGT000
23	24	33	37	—	41	50	53	48	—	MHQ1005P23NHT000
23	24	33	37	—	41	50	53	48	—	MHQ1005P23NJT000
24	25	35	41	—	39	49	50	44	—	MHQ1005P24NGT000
24	25	35	41	—	39	49	50	44	—	MHQ1005P24NHT000
24	25	35	41	—	39	49	50	44	—	MHQ1005P24NJT000
27	28	42	50	—	37	45	44	37	—	MHQ1005P27NGT000
27	28	42	50	—	37	45	44	37	—	MHQ1005P27NHT000
27	28	42	50	—	37	45	44	37	—	MHQ1005P27NJT000
30	32	55	—	—	33	40	34	—	—	MHQ1005P30NGT000
30	32	55	—	—	33	40	34	—	—	MHQ1005P30NHT000
30	32	55	—	—	33	40	34	—	—	MHQ1005P30NJT000

○ Measurement equipment

Product No.	Manufacturer
4291B+16193A	Keysight Technologies

* Equivalent measurement equipment may be used.

MHQ1005P type

ELECTRICAL CHARACTERISTICS

L, Q FREQUENCY CHARACTERISTICS TABLE

L(nH)typ.					Q typ.					Part No.
500MHz	800MHz	1.8GHz	2.0GHz	2.4GHz	500MHz	800MHz	1.8GHz	2.0GHz	2.4GHz	
33	35	59	—	—	37	44	37	—	—	MHQ1005P33NGT000
33	35	59	—	—	37	44	37	—	—	MHQ1005P33NHT000
33	35	59	—	—	37	44	37	—	—	MHQ1005P33NJT000
36	39	69	—	—	35	42	32	—	—	MHQ1005P36NGT000
36	39	69	—	—	35	42	32	—	—	MHQ1005P36NHT000
36	39	69	—	—	35	42	32	—	—	MHQ1005P36NJT000
40	43	—	—	—	33	38	—	—	—	MHQ1005P39NGT000
40	43	—	—	—	33	38	—	—	—	MHQ1005P39NHT000
40	43	—	—	—	33	38	—	—	—	MHQ1005P39NJT000
41	44	—	—	—	36	42	—	—	—	MHQ1005P40NGT000
41	44	—	—	—	36	42	—	—	—	MHQ1005P40NHT000
41	44	—	—	—	36	42	—	—	—	MHQ1005P40NJT000
44	47	—	—	—	36	42	—	—	—	MHQ1005P43NGT000
44	47	—	—	—	36	42	—	—	—	MHQ1005P43NHT000
44	47	—	—	—	36	42	—	—	—	MHQ1005P43NJT000
48	53	—	—	—	34	38	—	—	—	MHQ1005P47NGT000
48	53	—	—	—	34	38	—	—	—	MHQ1005P47NHT000
48	53	—	—	—	34	38	—	—	—	MHQ1005P47NJT000
52	58	—	—	—	35	40	—	—	—	MHQ1005P51NGT000
52	58	—	—	—	35	40	—	—	—	MHQ1005P51NHT000
52	58	—	—	—	35	40	—	—	—	MHQ1005P51NJT000
58	65	—	—	—	34	37	—	—	—	MHQ1005P56NGT000
58	65	—	—	—	34	37	—	—	—	MHQ1005P56NHT000
58	65	—	—	—	34	37	—	—	—	MHQ1005P56NJT000
65	74	—	—	—	34	37	—	—	—	MHQ1005P62NGT000
65	74	—	—	—	34	37	—	—	—	MHQ1005P62NHT000
65	74	—	—	—	34	37	—	—	—	MHQ1005P62NJT000
72	82	—	—	—	35	37	—	—	—	MHQ1005P68NGT000
72	82	—	—	—	35	37	—	—	—	MHQ1005P68NHT000
72	82	—	—	—	35	37	—	—	—	MHQ1005P68NJT000
77	90	—	—	—	34	36	—	—	—	MHQ1005P72NGT000
77	90	—	—	—	34	36	—	—	—	MHQ1005P72NHT000
77	90	—	—	—	34	36	—	—	—	MHQ1005P72NJT000
80	93	—	—	—	35	37	—	—	—	MHQ1005P75NGT000
80	93	—	—	—	35	37	—	—	—	MHQ1005P75NHT000
80	93	—	—	—	35	37	—	—	—	MHQ1005P75NJT000
88	107	—	—	—	35	35	—	—	—	MHQ1005P82NGT000
88	107	—	—	—	35	35	—	—	—	MHQ1005P82NHT000
88	107	—	—	—	35	35	—	—	—	MHQ1005P82NJT000
98	121	—	—	—	33	32	—	—	—	MHQ1005P91NGT000
98	121	—	—	—	33	32	—	—	—	MHQ1005P91NHT000
98	121	—	—	—	33	32	—	—	—	MHQ1005P91NJT000
111	143	—	—	—	33	33	—	—	—	MHQ1005PR10GT000
111	143	—	—	—	33	33	—	—	—	MHQ1005PR10HT000
111	143	—	—	—	33	33	—	—	—	MHQ1005PR10JT000

○ Measurement equipment

Product No.	Manufacturer
4291B+16193A	Keysight Technologies

* Equivalent measurement equipment may be used.

MHQ1005P type

ELECTRICAL CHARACTERISTICS

L, Q FREQUENCY CHARACTERISTICS TABLE

L(nH)typ.					Q typ.					Part No.
500MHz	800MHz	1.8GHz	2.0GHz	2.4GHz	500MHz	800MHz	1.8GHz	2.0GHz	2.4GHz	
124	169	—	—	—	31	28	—	—	—	MHQ1005PR11GT000
124	169	—	—	—	31	28	—	—	—	MHQ1005PR11HT000
124	169	—	—	—	31	28	—	—	—	MHQ1005PR11JT000
138	197	—	—	—	30	26	—	—	—	MHQ1005PR12GT000
138	197	—	—	—	30	26	—	—	—	MHQ1005PR12HT000
138	197	—	—	—	30	26	—	—	—	MHQ1005PR12JT000
150	220	—	—	—	31	23	—	—	—	MHQ1005PR13GT000
150	220	—	—	—	31	23	—	—	—	MHQ1005PR13HT000
150	220	—	—	—	31	23	—	—	—	MHQ1005PR13JT000
177	276	—	—	—	30	22	—	—	—	MHQ1005PR15GT000
177	276	—	—	—	30	22	—	—	—	MHQ1005PR15HT000
177	276	—	—	—	30	22	—	—	—	MHQ1005PR15JT000
194	—	—	—	—	28	—	—	—	—	MHQ1005PR16GT000
194	—	—	—	—	28	—	—	—	—	MHQ1005PR16HT000
194	—	—	—	—	28	—	—	—	—	MHQ1005PR16JT000
223	—	—	—	—	28	—	—	—	—	MHQ1005PR18GT000
223	—	—	—	—	28	—	—	—	—	MHQ1005PR18HT000
223	—	—	—	—	28	—	—	—	—	MHQ1005PR18JT000
254	—	—	—	—	27	—	—	—	—	MHQ1005PR20GT000
254	—	—	—	—	27	—	—	—	—	MHQ1005PR20HT000
254	—	—	—	—	27	—	—	—	—	MHQ1005PR20JT000
285	—	—	—	—	27	—	—	—	—	MHQ1005PR22GT000
285	—	—	—	—	27	—	—	—	—	MHQ1005PR22HT000
285	—	—	—	—	27	—	—	—	—	MHQ1005PR22JT000
317	—	—	—	—	26	—	—	—	—	MHQ1005PR24GT000
317	—	—	—	—	26	—	—	—	—	MHQ1005PR24HT000
317	—	—	—	—	26	—	—	—	—	MHQ1005PR24JT000
375	—	—	—	—	25	—	—	—	—	MHQ1005PR27GT000
375	—	—	—	—	25	—	—	—	—	MHQ1005PR27HT000
375	—	—	—	—	25	—	—	—	—	MHQ1005PR27JT000
448	—	—	—	—	23	—	—	—	—	MHQ1005PR30GT000
448	—	—	—	—	23	—	—	—	—	MHQ1005PR30HT000
448	—	—	—	—	23	—	—	—	—	MHQ1005PR30JT000
518	—	—	—	—	22	—	—	—	—	MHQ1005PR33GT000
518	—	—	—	—	22	—	—	—	—	MHQ1005PR33HT000
518	—	—	—	—	22	—	—	—	—	MHQ1005PR33JT000
599	—	—	—	—	21	—	—	—	—	MHQ1005PR36GT000
599	—	—	—	—	21	—	—	—	—	MHQ1005PR36HT000
599	—	—	—	—	21	—	—	—	—	MHQ1005PR36JT000
693	—	—	—	—	19	—	—	—	—	MHQ1005PR39GT000
693	—	—	—	—	19	—	—	—	—	MHQ1005PR39HT000
693	—	—	—	—	19	—	—	—	—	MHQ1005PR39JT000
—	—	—	—	—	—	—	—	—	—	MHQ1005PR43GT000
—	—	—	—	—	—	—	—	—	—	MHQ1005PR43HT000
—	—	—	—	—	—	—	—	—	—	MHQ1005PR43JT000
—	—	—	—	—	—	—	—	—	—	MHQ1005PR47GT000
—	—	—	—	—	—	—	—	—	—	MHQ1005PR47HT000
—	—	—	—	—	—	—	—	—	—	MHQ1005PR47JT000
—	—	—	—	—	—	—	—	—	—	MHQ1005PR51GT000
—	—	—	—	—	—	—	—	—	—	MHQ1005PR51HT000
—	—	—	—	—	—	—	—	—	—	MHQ1005PR51JT000
—	—	—	—	—	—	—	—	—	—	MHQ1005PR56GT000
—	—	—	—	—	—	—	—	—	—	MHQ1005PR56HT000
—	—	—	—	—	—	—	—	—	—	MHQ1005PR56JT000

○ Measurement equipment

Product No.	Manufacturer
4291B+16193A	Keysight Technologies

* Equivalent measurement equipment may be used.

⚠ Please be sure to request delivery specifications that provide further details on the features and specifications of the products for proper and safe use.
Please note that the contents may change without any prior notice due to reasons such as upgrading.

MHQ1005P type

ELECTRICAL CHARACTERISTICS

L FREQUENCY CHARACTERISTICS GRAPH (EXAMPLE)

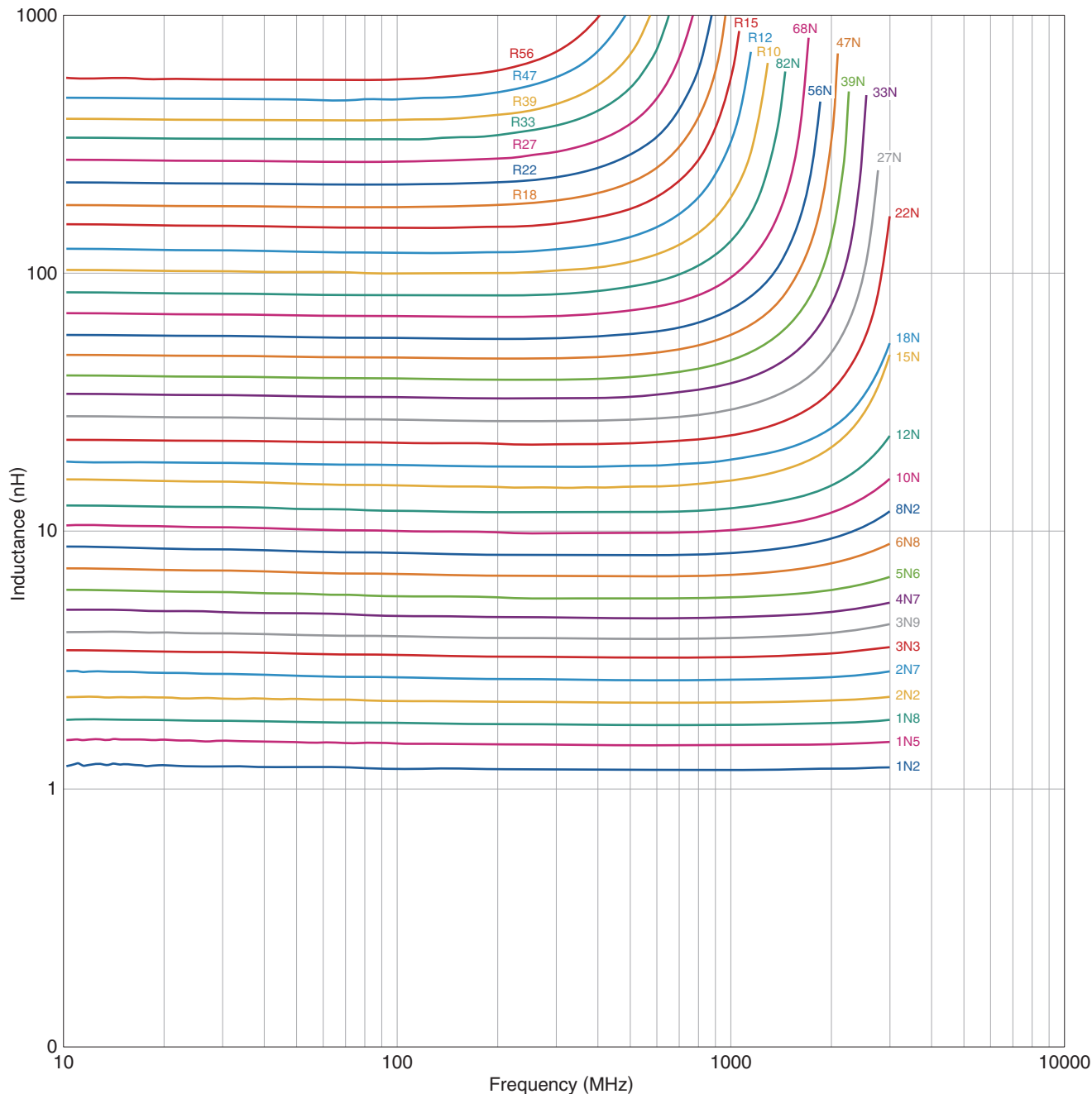

○ Measurement equipment

Product No.	Manufacturer
E4991+16193A	Keysight Technologies

* Equivalent measurement equipment may be used.

⚠ Please be sure to request delivery specifications that provide further details on the features and specifications of the products for proper and safe use. Please note that the contents may change without any prior notice due to reasons such as upgrading.

MHQ1005P type

ELECTRICAL CHARACTERISTICS

Q FREQUENCY CHARACTERISTICS GRAPH (EXAMPLE)

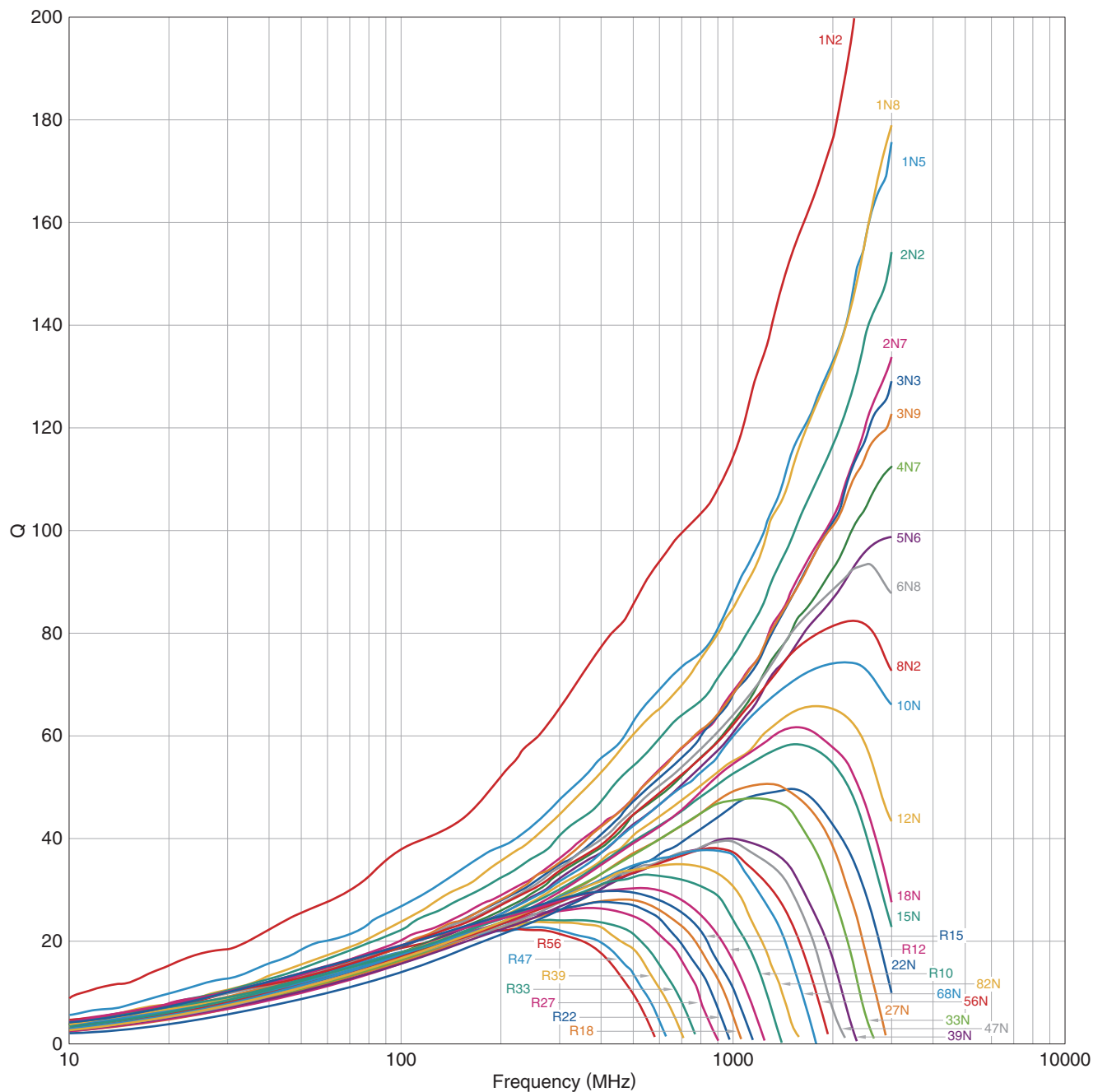

○ Measurement equipment

Product No.	Manufacturer
E4991+16193A	Keysight Technologies

* Equivalent measurement equipment may be used.

⚠ Please be sure to request delivery specifications that provide further details on the features and specifications of the products for proper and safe use.
Please note that the contents may change without any prior notice due to reasons such as upgrading.

MHQ1005P type

PACKAGING STYLE

REEL DIMENSIONS

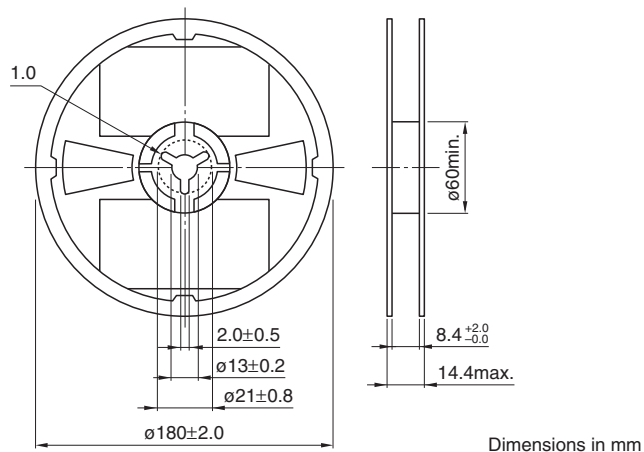

TAPE DIMENSIONS

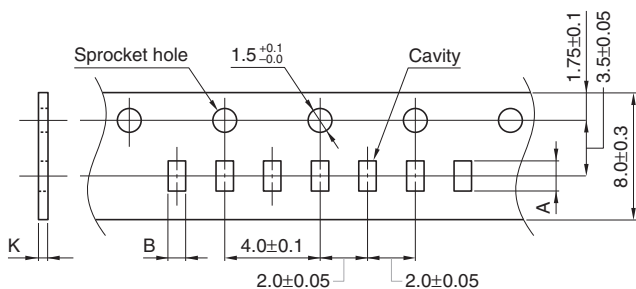

Type	A	B	K
MHQ1005P	1.15±0.10	0.75±0.10	0.8 max.

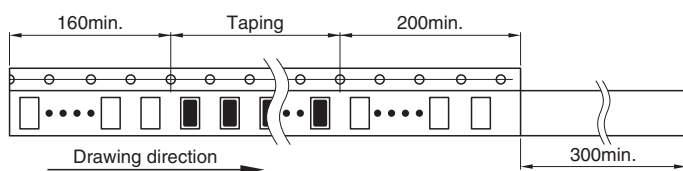

Please be sure to request delivery specifications that provide further details on the features and specifications of the products for proper and safe use. Please note that the contents may change without any prior notice due to reasons such as upgrading.

X-ON Electronics

Largest Supplier of Electrical and Electronic Components

Click to view similar products for [Fixed Inductors](#) category:

Click to view products by [TDK](#) manufacturer:

Other Similar products are found below :

[MLZ1608M6R8WTD25](#) [MLZ1608N6R8LT000](#) [MLZ1608N3R3LTD25](#) [MLZ1608N3R3LT000](#) [MLZ1608N150LT000](#)
[MLZ1608M150WTD25](#) [MLZ1608M3R3WTD25](#) [MLZ1608M3R3WT000](#) [MLZ1608M150WT000](#) [MLZ1608A1R5WT000](#)
[MLZ1608N1R5LT000](#) [B82432C1333K000](#) [PCMB053T-1R0MS](#) [PCMB053T-1R5MS](#) [PCMB104T-1R5MS](#) [CR32NP-100KC](#) [CR32NP-151KC](#) [CR32NP-180KC](#) [CR32NP-181KC](#) [CR32NP-1R5MC](#) [CR32NP-390KC](#) [CR32NP-3R9MC](#) [CR32NP-680KC](#) [CR32NP-820KC](#)
[CR32NP-8R2MC](#) [CR43NP-390KC](#) [CR43NP-560KC](#) [CR43NP-680KC](#) [CR54NP-181KC](#) [CR54NP-470LC](#) [CR54NP-820KC](#) [CR54NP-8R5MC](#)
[MGDQ4-00004-P](#) [MGDU1-00016-P](#) [MHL1ECTTP18NJ](#) [MHL1JCTTD12NJ](#) [PE-51506NL](#) [PE-53601NL](#) [PE-53630NL](#) [PE-53824SNLT](#) [PE-62892NL](#) [PE-92100NL](#) [PG0434.801NLT](#) [PG0936.113NLT](#) [PM06-2N7](#) [PM06-39NJ](#) [HC2LP-R47-R](#) [HC2-R47-R](#) [HC3-2R2-R](#) [HC8-1R2-R](#)