

# C2M0045170P

## Silicon Carbide Power MOSFET

### C2M™ MOSFET Technology

#### N-Channel Enhancement Mode

#### Features

- Optimized package with separate driver source pin
- 8mm of creepage distance between drain and source
- High Blocking Voltage with Low On-Resistance
- High Speed Switching with Low Capacitances
- Easy to Parallel and Simple to Drive
- Halogen Free, RoHS Compliant

#### Benefits

- Reduce switching losses and minimize gate ringing
- Higher system efficiency
- Reduce cooling requirements
- Increase power density
- Increase system switching frequency

#### Applications

- 1500V Solar Inverters
- Switch Mode Power Supplies
- High Voltage DC/DC converters
- Pulsed Power Applications

#### Maximum Ratings ( $T_C = 25^\circ\text{C}$ unless otherwise specified)

Symbol	Parameter	Value	Unit	Test Conditions	Note
$V_{DSmax}$	Drain - Source Voltage	1700	V	$V_{GS} = 0\text{ V}, I_D = 100\ \mu\text{A}$	
$V_{GSmax}$	Gate - Source Voltage (dynamic)	-10/+25	V	AC ( $f > 1\text{ Hz}$ )	Note: 1
$V_{GSop}$	Gate - Source Voltage (Static)	-5/+20	V	Static	Note: 2
$I_D$	Continuous Drain Current	72	A	$V_{GS} = 20\text{ V}, T_C = 25^\circ\text{C}$	Fig. 19
		48		$V_{GS} = 20\text{ V}, T_C = 100^\circ\text{C}$	
$I_{D(pulse)}$	Pulsed Drain Current	160	A	Pulse width $t_p$ limited by $T_{jmax}$	Fig. 22
$P_D$	Power Dissipation	520	W	$T_C = 25^\circ\text{C}, T_J = 150^\circ\text{C}$	Fig. 20
$T_J, T_{stg}$	Operating Junction and Storage Temperature	-40 to +150	$^\circ\text{C}$		
$T_L$	Solder Temperature	260	$^\circ\text{C}$	1.6mm (0.063") from case for 10s	

Note (1): When using MOSFET Body Diode  $V_{GSmax} = -5\text{V}/+25\text{V}$

Note (2): MOSFET can also safely operate at  $0/+20\text{V}$

$V_{DS}$	1700 V
$I_D @ 25^\circ\text{C}$	72 A
$R_{DS(on)}$	45 m $\Omega$

#### Package

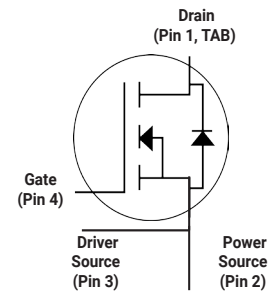

Part Number	Package	Marking
C2M0045170P	TO-247-4 Plus	C2M0045170P



## Electrical Characteristics (T<sub>c</sub> = 25°C unless otherwise specified)

Symbol	Parameter	Min.	Typ.	Max.	Unit	Test Conditions	Note
V <sub>(BR)DSS</sub>	Drain-Source Breakdown Voltage	1700			V	V <sub>GS</sub> = 0 V, I <sub>D</sub> = 100 μA	
V <sub>GS(th)</sub>	Gate Threshold Voltage	2.0	2.6	4	V	V <sub>DS</sub> = V <sub>GS</sub> , I <sub>D</sub> = 18mA	Fig. 11
			1.8		V	V <sub>DS</sub> = V <sub>GS</sub> , I <sub>D</sub> = 18mA, T <sub>J</sub> = 150 °C	
I <sub>DSS</sub>	Zero Gate Voltage Drain Current		2	100	μA	V <sub>DS</sub> = 1700 V, V <sub>GS</sub> = 0 V	
I <sub>GSS</sub>	Gate-Source Leakage Current			600	nA	V <sub>GS</sub> = 20 V, V <sub>DS</sub> = 0 V	
R <sub>DS(on)</sub>	Drain-Source On-State Resistance		45	59	mΩ	V <sub>GS</sub> = 20 V, I <sub>D</sub> = 50 A	Fig. 4,5,6
			90			V <sub>GS</sub> = 20 V, I <sub>D</sub> = 50 A, T <sub>J</sub> = 150 °C	
g <sub>fs</sub>	Transconductance		21.7		S	V <sub>DS</sub> = 20 V, I <sub>DS</sub> = 50 A	Fig. 7
			24.4			V <sub>DS</sub> = 20 V, I <sub>DS</sub> = 50 A, T <sub>J</sub> = 150 °C	
C <sub>iss</sub>	Input Capacitance		3672		pF	V <sub>GS</sub> = 0 V	Fig. 17,18
C <sub>oss</sub>	Output Capacitance		171			V <sub>DS</sub> = 1000 V	
C <sub>rss</sub>	Reverse Transfer Capacitance		6.7			f = 1 MHz	
E <sub>oss</sub>	C <sub>oss</sub> Stored Energy		105			μJ	V <sub>AC</sub> = 25 mV
E <sub>ON</sub>	Turn-On Switching Energy (SiC Diode FWD)		0.67		mJ	V <sub>DS</sub> = 1200 V, V <sub>GS</sub> = -5/20 V, I <sub>D</sub> = 50A, R <sub>G(ext)</sub> = 2.5Ω, L = 105 μH, T <sub>J</sub> = 150 °C, using SiC Diode as FWD	Fig. 26, 29b
E <sub>OFF</sub>	Turn Off Switching Energy (SiC Diode FWD)		0.31				
E <sub>ON</sub>	Turn-On Switching Energy (Body Diode FWD)		2.8		mJ	V <sub>DS</sub> = 1200 V, V <sub>GS</sub> = -5/20 V, I <sub>D</sub> = 50A, R <sub>G(ext)</sub> = 2.5Ω, L = 105 μH, T <sub>J</sub> = 150 °C, using MOSFET as FWD	Fig. 26, 29a
E <sub>OFF</sub>	Turn Off Switching Energy (Body Diode FWD)		0.35				
t <sub>d(on)</sub>	Turn-On Delay Time		35		ns	V <sub>DD</sub> = 1200 V, V <sub>GS</sub> = -5/20 V I <sub>D</sub> = 50 A, R <sub>G(ext)</sub> = 2.5 Ω, Timing relative to V <sub>DS</sub> Inductive load	Fig. 27, 29
t <sub>r</sub>	Rise Time		13				
t <sub>d(off)</sub>	Turn-Off Delay Time		46				
t <sub>f</sub>	Fall Time		10				
R <sub>G(int)</sub>	Internal Gate Resistance		1.3		Ω	f = 1 MHz, V <sub>AC</sub> = 25 mV	
Q <sub>gs</sub>	Gate to Source Charge		44		nC	V <sub>DS</sub> = 1200 V, V <sub>GS</sub> = -5/20 V I <sub>D</sub> = 50 A	Fig. 12
Q <sub>gd</sub>	Gate to Drain Charge		57				
Q <sub>g</sub>	Total Gate Charge		188				

## Reverse Diode Characteristics

Symbol	Parameter	Typ.	Max.	Unit	Test Conditions	Note
V <sub>SD</sub>	Diode Forward Voltage	4.1		V	V <sub>GS</sub> = -5 V, I <sub>SD</sub> = 25 A	Fig. 8, 9, 10 Note 1
		3.6		V	V <sub>GS</sub> = -5 V, I <sub>SD</sub> = 25 A, T <sub>J</sub> = 150 °C	
I <sub>S</sub>	Continuous Diode Forward Current		72	A	T <sub>c</sub> = 25 °C, V <sub>GS</sub> = -5 V	Note 1
t <sub>rr</sub>	Reverse Recovery Time	44		ns	V <sub>GS</sub> = -5 V, I <sub>SD</sub> = 50 A, V <sub>R</sub> = 1200 V dif/dt = 3000 A/μs	Note 1
Q <sub>rr</sub>	Reverse Recovery Charge	2		μC		
I <sub>rrm</sub>	Peak Reverse Recovery Current	60		A		

Note (1): When using SiC Body Diode the maximum recommended V<sub>GS</sub> = -5V

## Thermal Characteristics

Symbol	Parameter	Typ.	Max.	Unit	Test Conditions	Note
R <sub>θJC</sub>	Thermal Resistance from Junction to Case	0.22	0.24	°C/W		Fig. 21
R <sub>θJA</sub>	Thermal Resistance from Junction to Ambient		40			

## Typical Performance

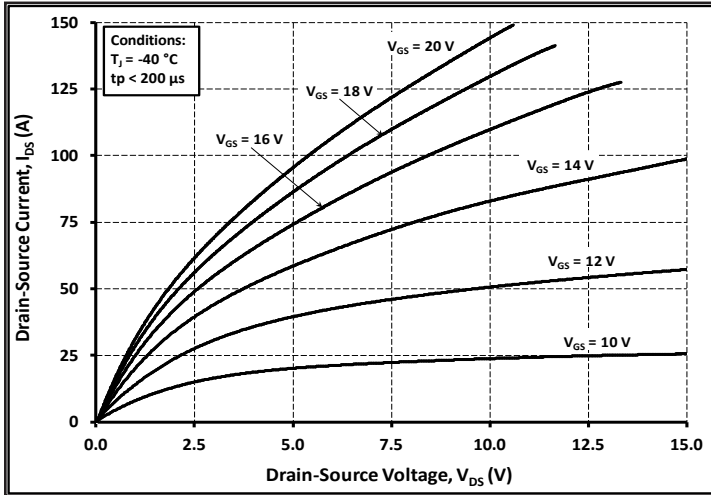

Figure 1. Output Characteristics  $T_J = -40\text{ }^\circ\text{C}$

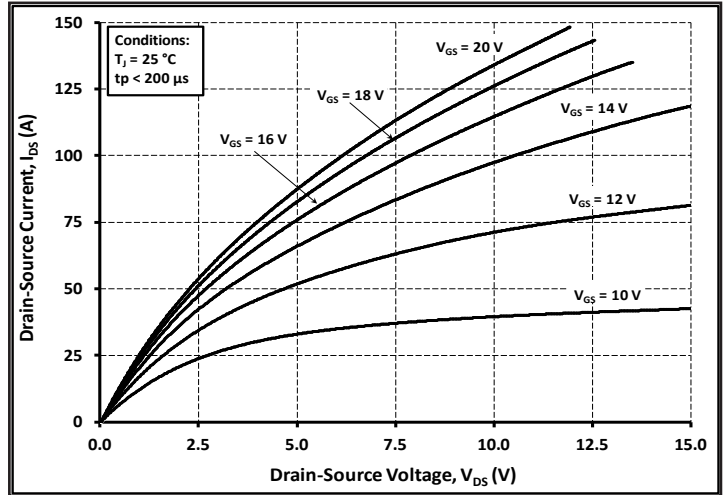

Figure 2. Output Characteristics  $T_J = 25\text{ }^\circ\text{C}$

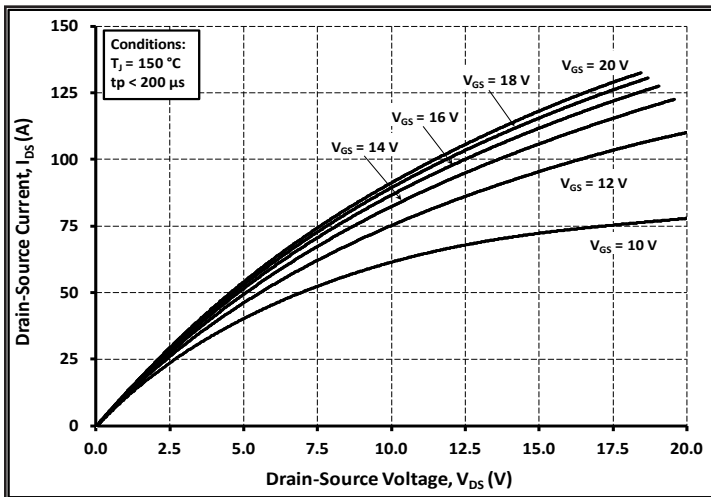

Figure 3. Output Characteristics  $T_J = 150\text{ }^\circ\text{C}$

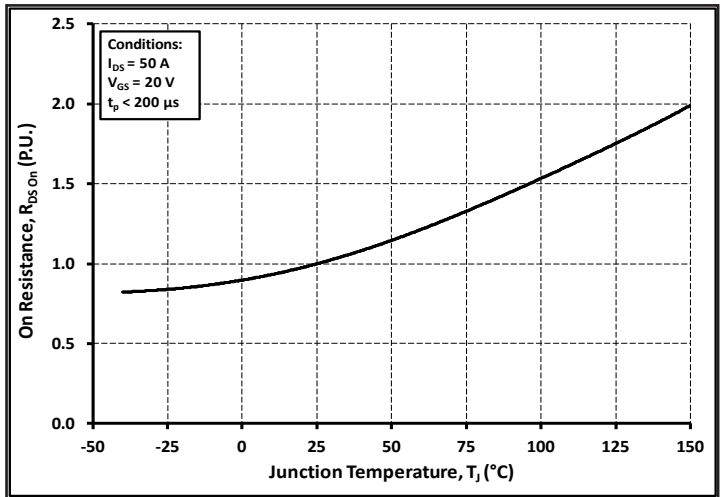

Figure 4. Normalized On-Resistance vs. Temperature

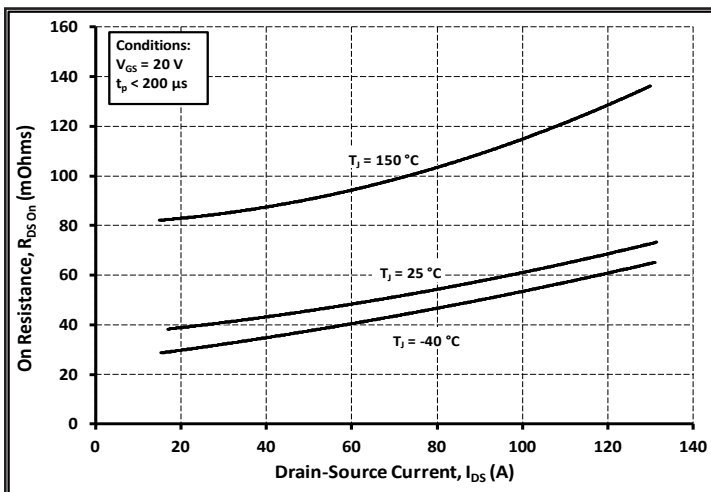

Figure 5. On-Resistance vs. Drain Current For Various Temperatures

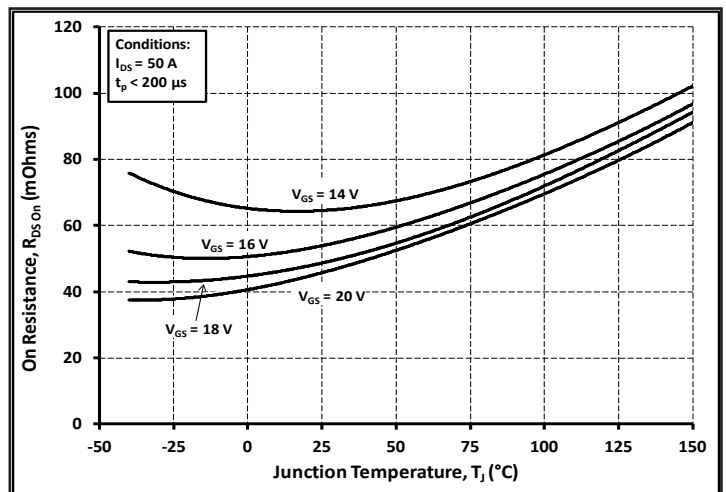

Figure 6. On-Resistance vs. Temperature For Various Gate Voltage

## Typical Performance

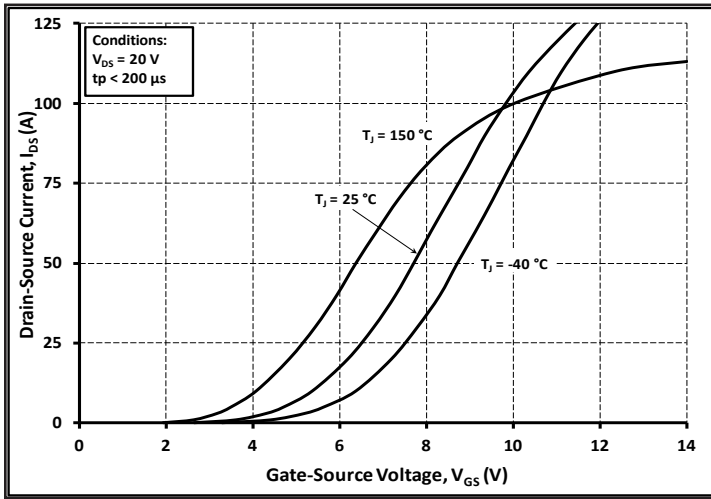

Figure 7. Transfer Characteristic For Various Junction Temperatures

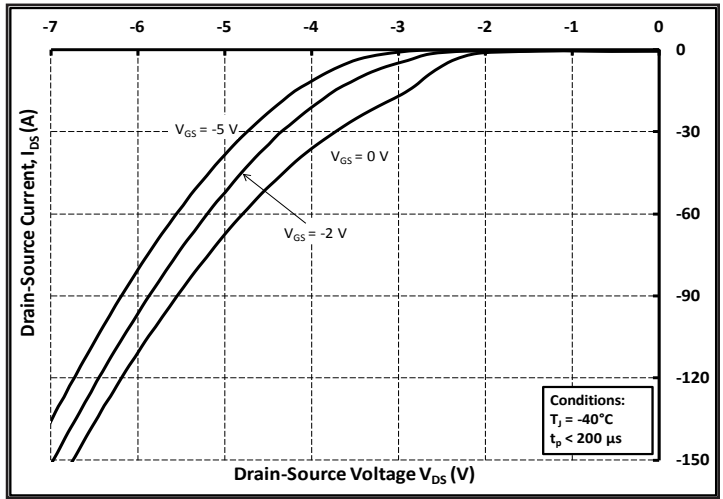

Figure 8. Body Diode Characteristic at  $-40\text{ }^\circ\text{C}$

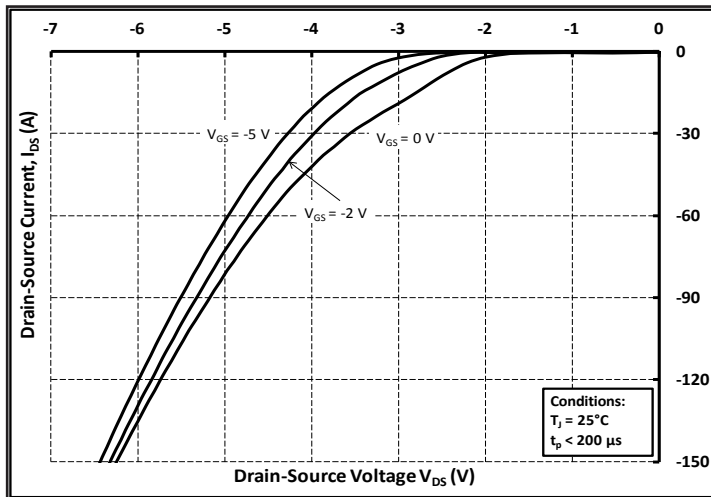

Figure 9. Body Diode Characteristic at  $25\text{ }^\circ\text{C}$

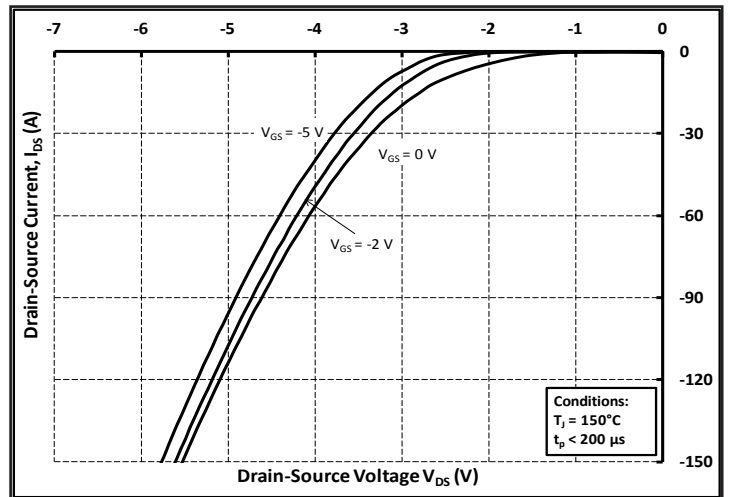

Figure 10. Body Diode Characteristic at  $150\text{ }^\circ\text{C}$

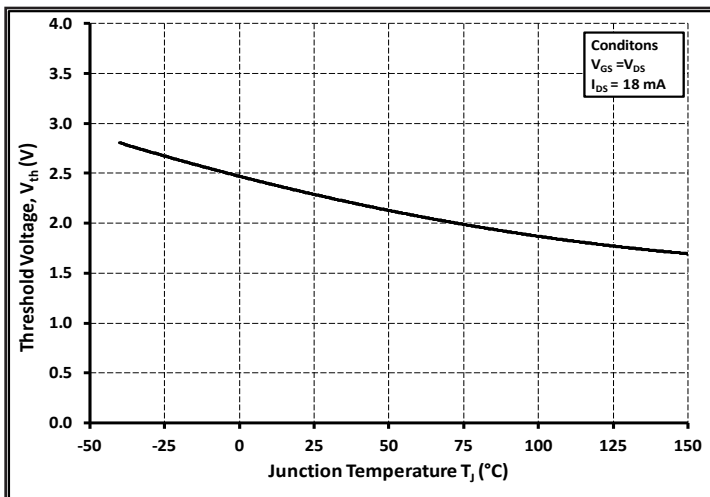

Figure 11. Threshold Voltage vs. Temperature

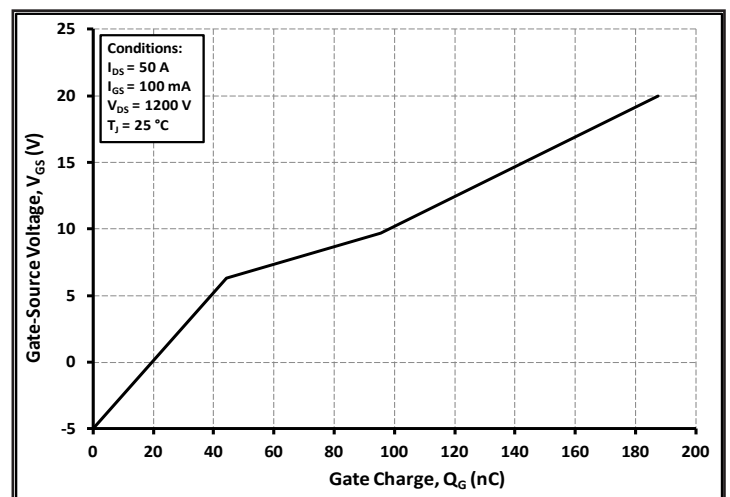

Figure 12. Gate Charge Characteristic

## Typical Performance

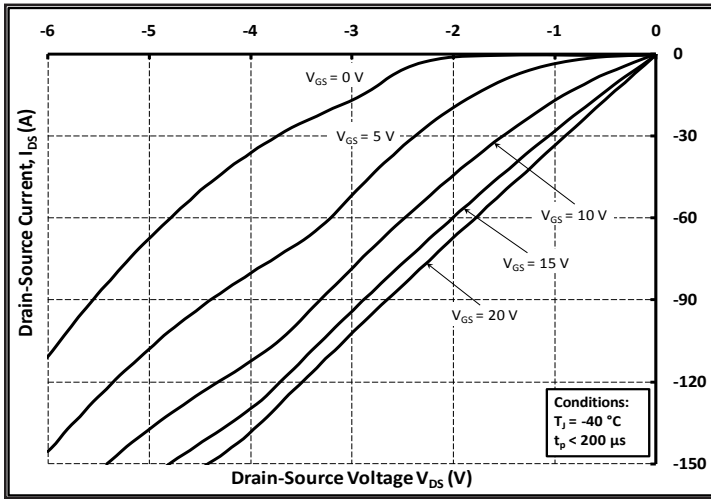

Figure 13. 3rd Quadrant Characteristic at -40 °C

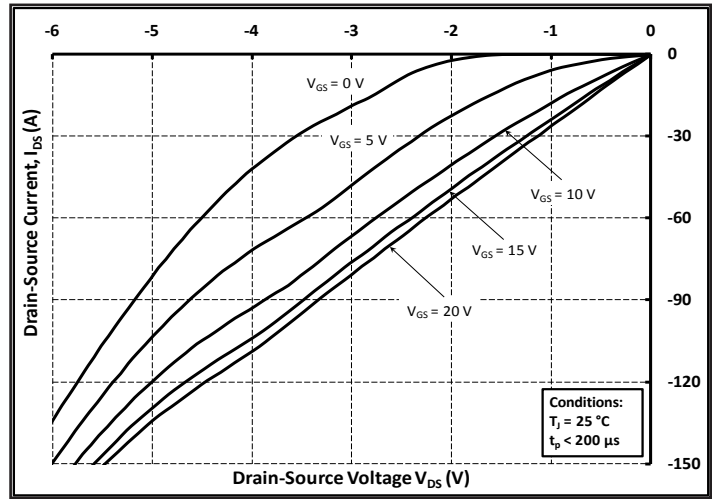

Figure 14. 3rd Quadrant Characteristic at 25 °C

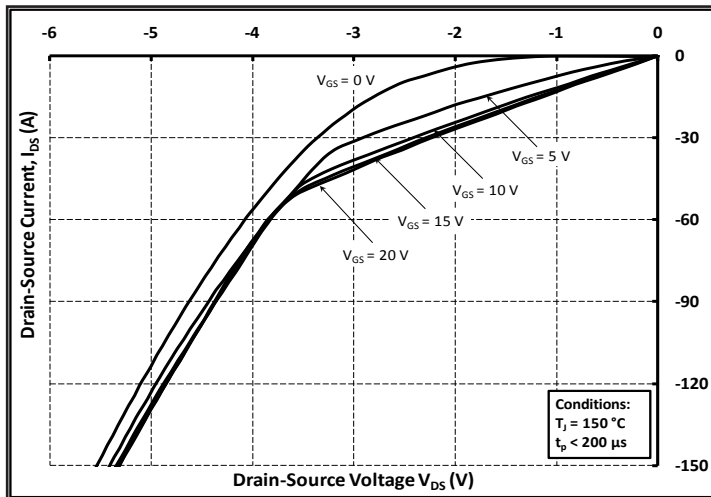

Figure 15. 3rd Quadrant Characteristic at 150 °C

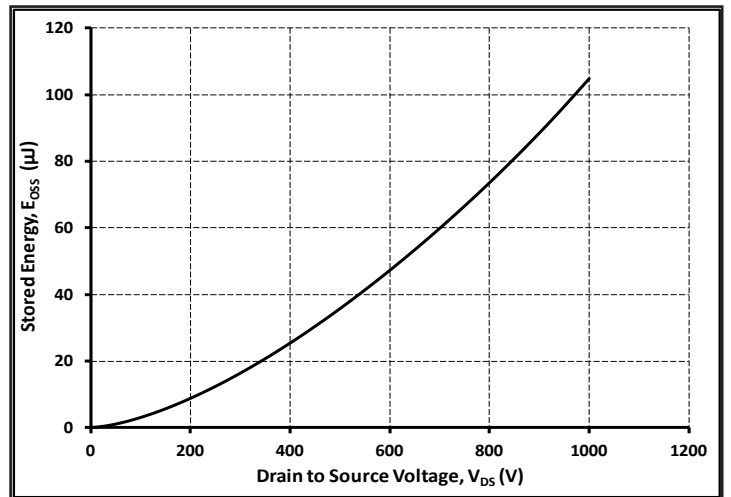

Figure 16. Output Capacitor Stored Energy

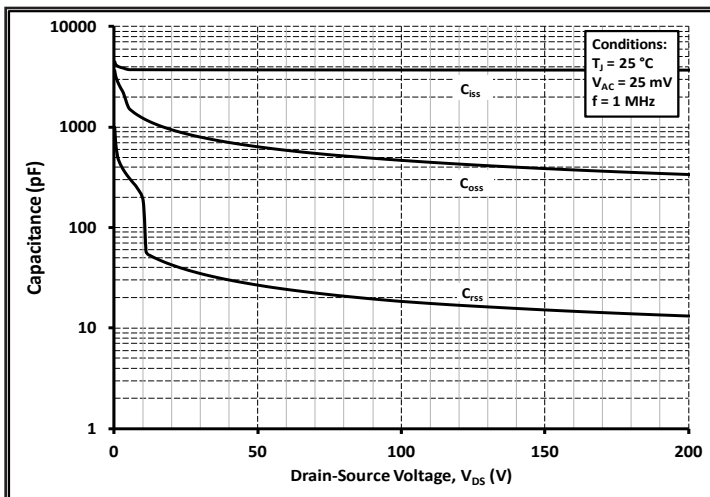

Figure 17. Capacitances vs. Drain-Source Voltage (0-200 V)

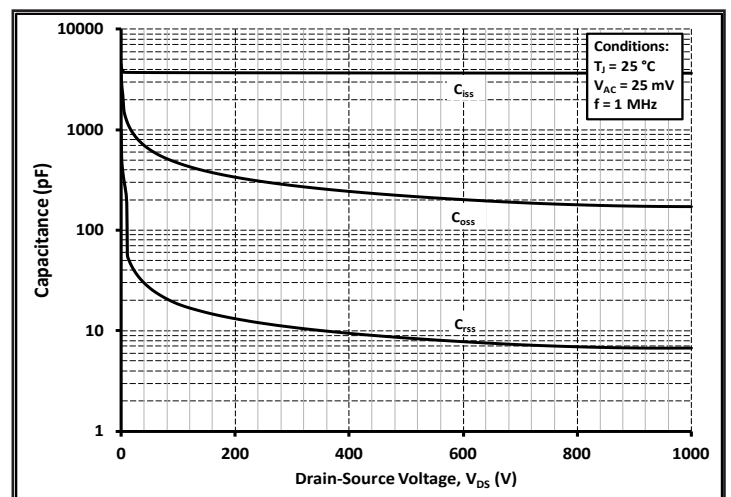

Figure 18. Capacitances vs. Drain-Source Voltage (0-1000 V)

## Typical Performance

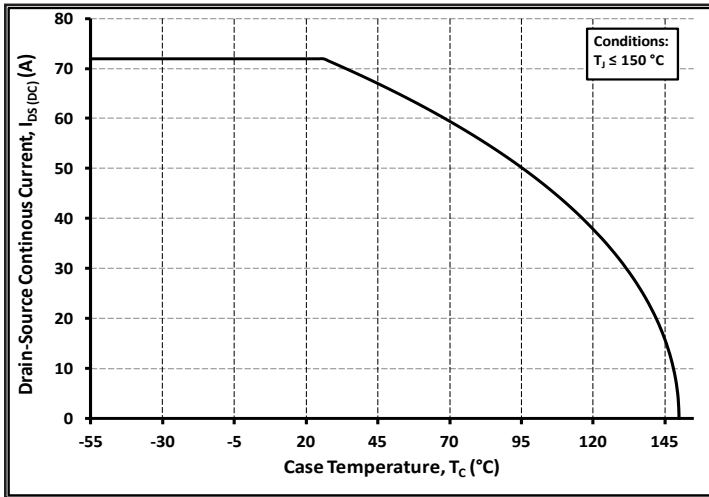

Figure 19. Continuous Drain Current Derating vs. Case Temperature

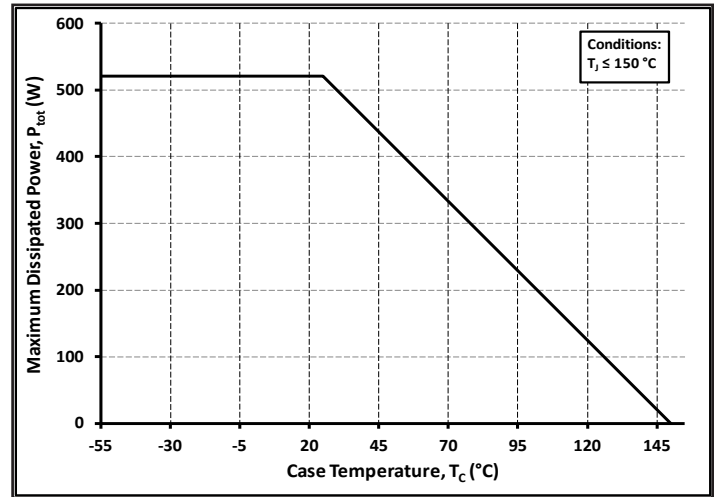

Figure 20. Maximum Power Dissipation Derating vs. Case Temperature

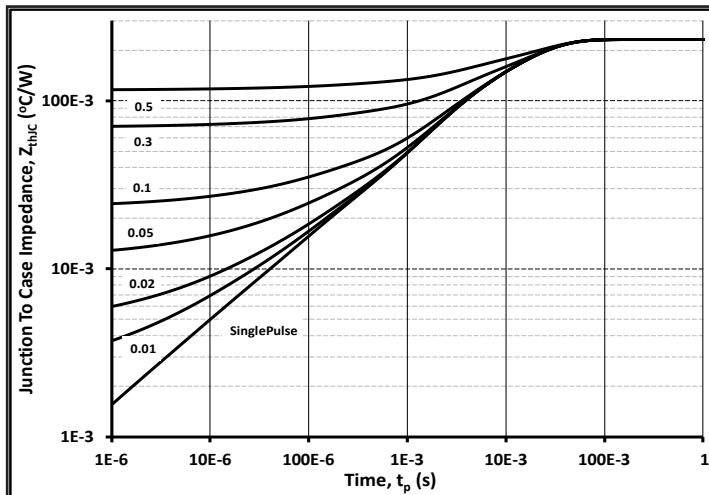

Figure 21. Transient Thermal Impedance (Junction - Case)

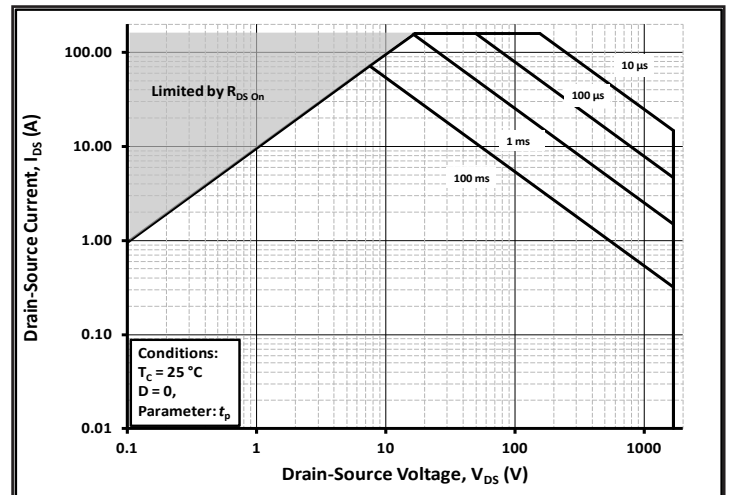

Figure 22. Safe Operating Area

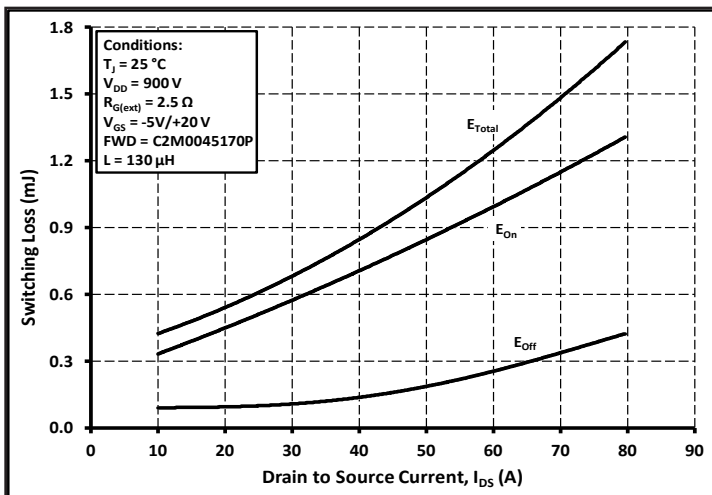

Figure 23. Clamped Inductive Switching Energy vs. Drain Current ( $V_{DD} = 900V$ )

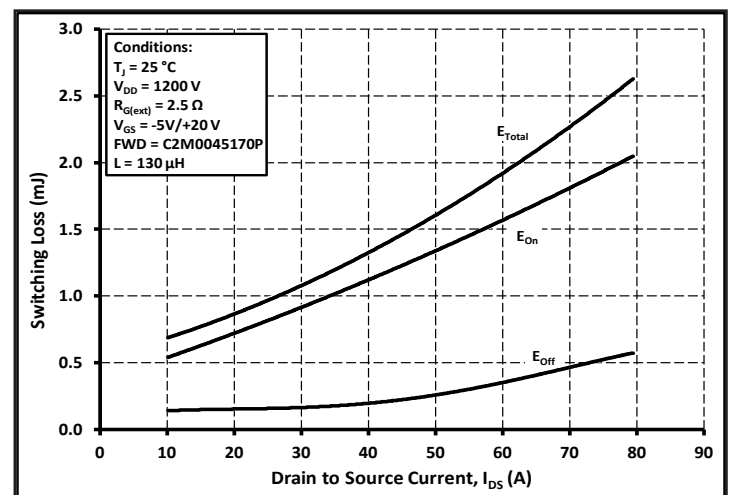

Figure 24. Clamped Inductive Switching Energy vs. Drain Current ( $V_{DD} = 1200V$ )

## Typical Performance

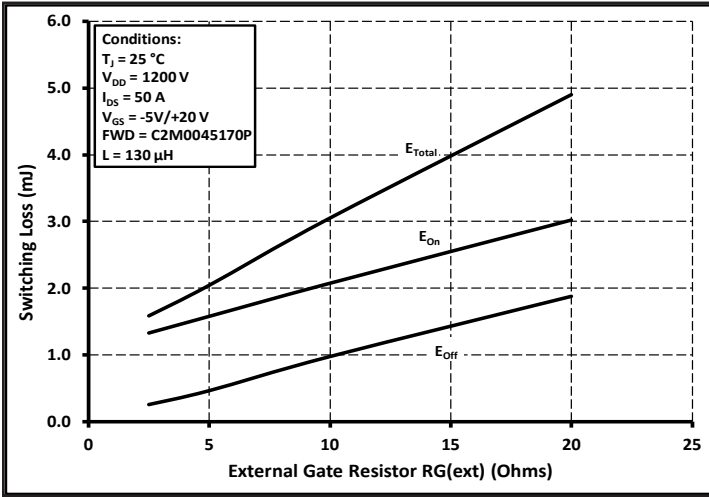

Figure 25. Clamped Inductive Switching Energy vs.  $R_{G(ext)}$

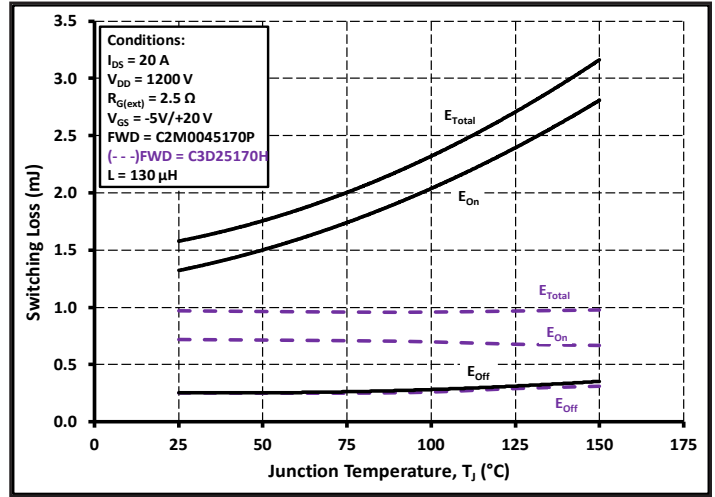

Figure 26. Clamped Inductive Switching Energy vs. Temperature

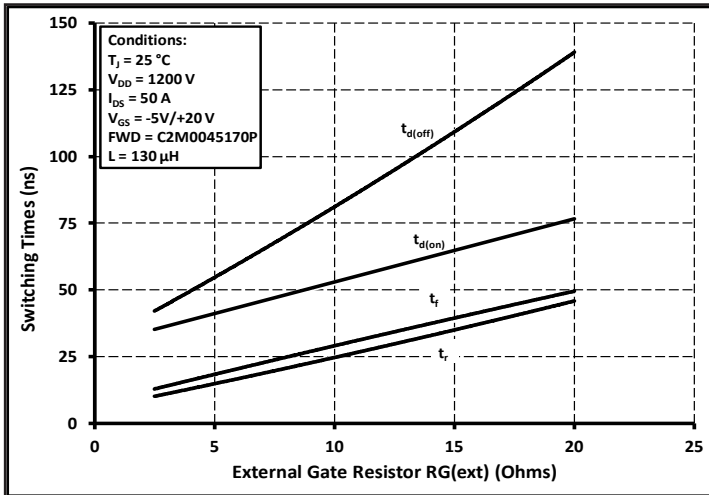

Figure 27. Switching Times vs.  $R_{G(ext)}$



Figure 28. Switching Times Definition

**Test Circuit Schematic**

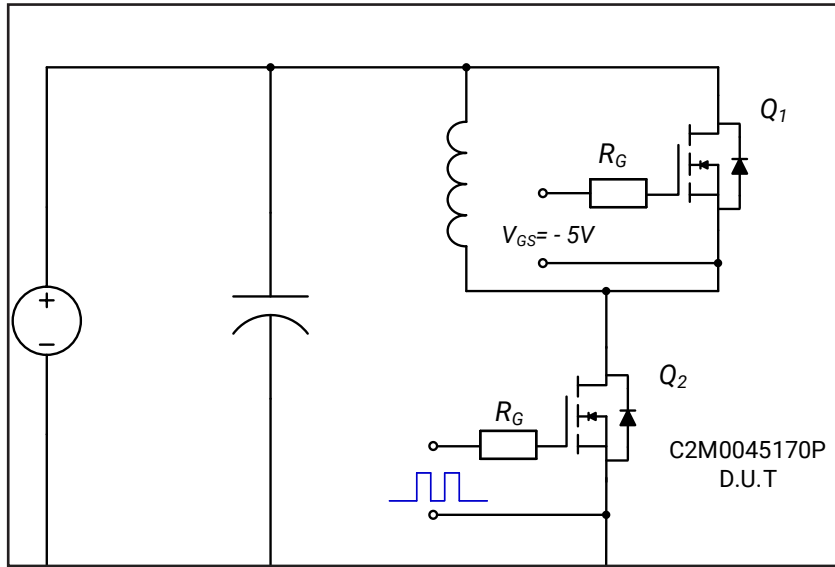

Figure 29a. Clamped Inductive Switching Test Circuit using MOSFET intrinsic body diode

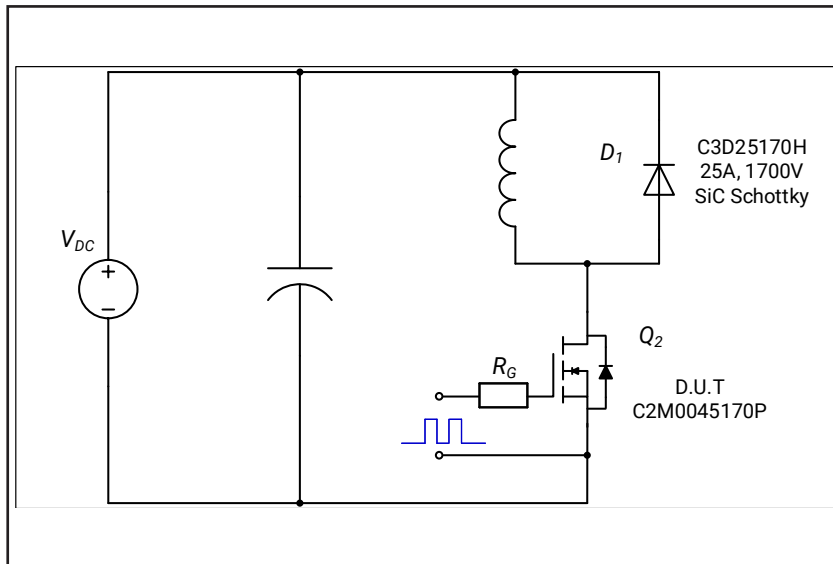
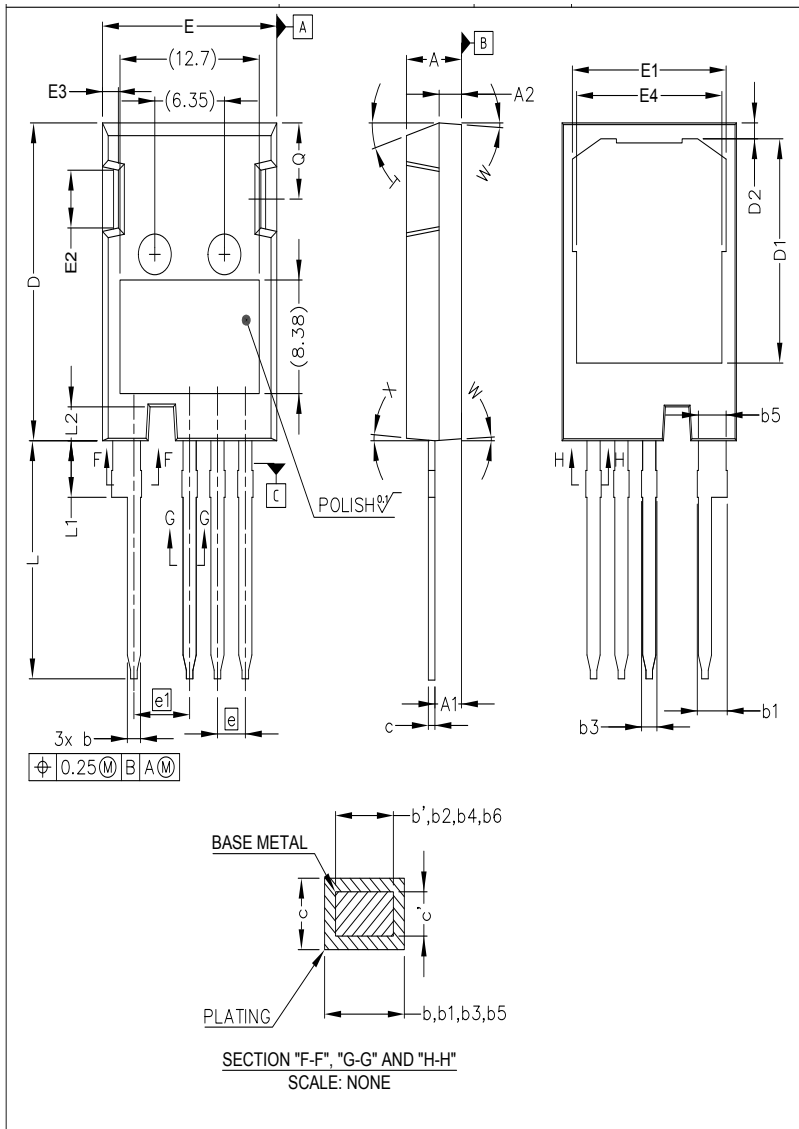

Figure 29b. Clamped Inductive Switching Test Circuit using SiC Schottky diode



## Package Dimensions

Package TO-247-4L Plus



SYM	MILLIMETERS	
	MIN	MAX
A	4.83	5.21
A1	2.29	2.54
A2	1.91	2.16
b'	1.07	1.28
b	1.07	1.33
b1	2.39	2.94
b2	2.39	2.84
b3	1.07	1.60
b4	1.07	1.50
b5	2.39	2.69
b6	2.39	2.64
c'	0.55	0.65
c	0.55	0.68
D	23.30	23.60
D1	16.25	17.65
D2	0.95	1.25
E	15.75	16.13
E1	13.10	14.15
E2	3.68	5.10
E3	1.00	1.90
E4	12.38	13.43
e	2.54 BSC	
e1	5.08 BSC	
N	4	
L	17.31	17.82
L1	3.97	4.37
L2	2.35	2.65
Q	5.49	6.00
T	17.5° REF.	
W	3.5° REF.	
X	4° REF.	

### Recommended Solder Pad Layout

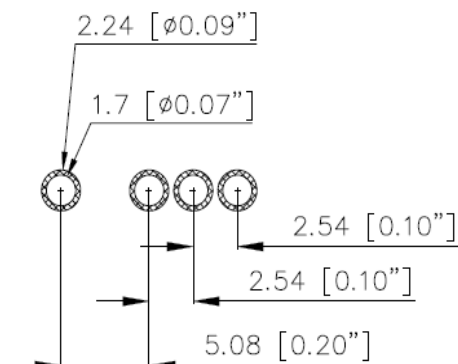

## Notes

---

- **RoHS Compliance**  
The levels of RoHS restricted materials in this product are below the maximum concentration values (also referred to as the threshold limits) permitted for such substances, or are used in an exempted application, in accordance with EU Directive 2011/65/EC (RoHS2), as implemented January 2, 2013. RoHS Declarations for this product can be obtained from your Cree representative or from the Product Documentation sections of [www.cree.com](http://www.cree.com).
- **REACH Compliance**  
REACH substances of high concern (SVHCs) information is available for this product. Since the European Chemical Agency (ECHA) has published notice of their intent to frequently revise the SVHC listing for the foreseeable future, please contact a Cree representative to insure you get the most up-to-date REACH SVHC Declaration. REACH banned substance information (REACH Article 67) is also available upon request.
- This product has not been designed or tested for use in, and is not intended for use in, applications implanted into the human body nor in applications in which failure of the product could lead to death, personal injury or property damage, including but not limited to equipment used in the operation of nuclear facilities, life-support machines, cardiac defibrillators or similar emergency medical equipment, aircraft navigation or communication or control systems, air traffic control systems.

## Related Links

---

- **C2M PSPICE Models:** <http://wolfspeed.com/power/tools-and-support>
- **SiC MOSFET Isolated Gate Driver reference design:** <http://wolfspeed.com/power/tools-and-support>
- **SiC MOSFET Evaluation Board:** <http://wolfspeed.com/power/tools-and-support>

## X-ON Electronics

Largest Supplier of Electrical and Electronic Components

*Click to view similar products for [MOSFET](#) category:*

*Click to view products by [Wolfspeed](#) manufacturer:*

Other Similar products are found below :

[614233C](#) [648584F](#) [MCH3443-TL-E](#) [MCH6422-TL-E](#) [FDPF9N50NZ](#) [FW231A-TL-E](#) [APT5010JVR](#) [NTNS3A92PZT5G](#) [IRF100S201](#)  
[JANTX2N5237](#) [2SK2464-TL-E](#) [2SK3818-DL-E](#) [FCA20N60\\_F109](#) [FDZ595PZ](#) [STD6600NT4G](#) [FSS804-TL-E](#) [2SJ277-DL-E](#) [2SK1691-DL-](#)  
[E](#) [2SK2545\(Q,T\)](#) [D2294UK](#) [405094E](#) [423220D](#) [MCH6646-TL-E](#) [TPCC8103,L1Q\(CM](#) [367-8430-0972-503](#) [VN1206L](#) [424134F](#) [026935X](#)  
[051075F](#) [SBVS138LT1G](#) [614234A](#) [715780A](#) [NTNS3166NZT5G](#) [751625C](#) [873612G](#) [IRF7380TRHR](#) [IPS70R2K0CEAKMA1](#)  
[RJK60S3DPP-E0#T2](#) [RJK60S5DPK-M0#T0](#) [APT5010JVFR](#) [APT12031JFLL](#) [APT12040JVR](#) [DMN3404LQ-7](#) [NTE6400](#) [JANTX2N6796U](#)  
[JANTX2N6784U](#) [JANTXV2N5416U4](#) [SQM110N05-06L-GE3](#) [SIHF35N60E-GE3](#) [2SK2614\(TE16L1,Q\)](#)