

Data sheet

# Circuit breakers / Manual motor starters

## Type CTI 15

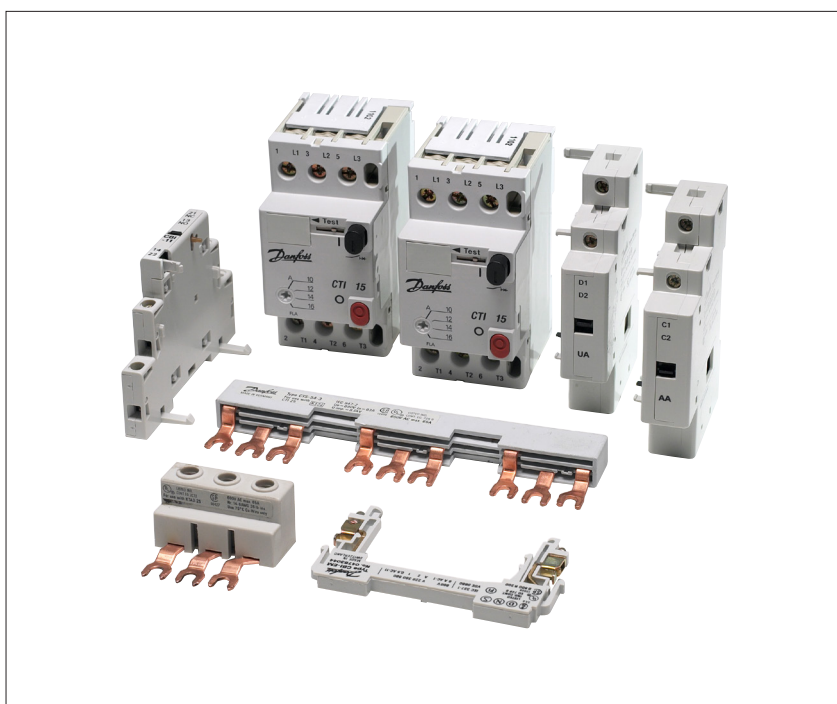

Circuit breakers/Manual motor starters CTI 15 cover the power ranges 0.09 – 7.5 kW

This product range is modular, flexible, and offers a large selection of clip-on auxiliary functions and accessories: auxiliary contact blocks, shunt releases, connection terminal, bus bars and enclosures.

### Features

- Short-circuit protection:  
An advanced and fast reacting contact system with arc-control devices give CTI high short-circuit break capability which makes them very suitable for the protection of electrical panels.
- Indicating functions:
  - condition (ON or OFF)
- Supply isolation:
  - operation switch (manual motor starter)
  - isolation switch (with locking device)
  - emergency stop switch (with undervoltage trip)

**Ordering**

**Circuit breakers/Manual motor starters CTI 15**

Type	AC-3 load $U_e$ 380 – 415 V	Range Motor starter	Electromagnetic trip current	Code no.
	[kW]	[A]	[A]	
CTI 15	0.09	0.25 – 0.4	4.4	047B3051
	0.12	0.4 – 0.63	6.9	047B3052
	0.37	0.63 – 1.0	11	047B3053
	0.55	1.0 – 1.6	18	047B3054
	0.75	1.6 – 2.5	28	047B3055
	1.5	2.5 – 4.0	44	047B3056
	2.5	4.0 – 6.3	69	047B3057
	5.5	6.3 – 10	110	047B3058
	7.5	10 – 16	176	047B3059
	12.5	20 – 25	275	047B3060

**CBI-NO / CBI-NC  
Auxiliary contact block**

**CBI-11  
Auxiliary contact block**

**CBI-UA / CBI-AA  
Undervoltage trip/ Shunt trip**

**Enclosure BXI  
For CTI 15**

**CTT 25  
Terminal block**

**CTS 54-  
Bus bar**

Description	Comments	Code no.
Auxiliary contact blocks for CTI 15	<i>Auxiliary contact blocks for building in</i>	
	CBI-NO (make) terminal 13 – 14	047B3040
	CBI-NO (make) terminal 23 – 24	047B3041
	CBI-NC (break) terminal 11 – 12	047B3042
	<i>Auxiliary contact blocks for lefthand mounting</i>	
Undervoltage for CTI 15	<i>Undervoltage trip for righthand mounting</i>	
	CBI-UA 220 – 230 V, 50 Hz – 254 V, 60 Hz, D1 – D2	047B3061
Shunt trip for CTI 15	<i>Shunt trip for righthand mounting</i>	
	CBI-AA 220 – 230 V, 50 Hz – 254 V, 60 Hz, C1 – C2	047B3067
Terminal block for CTI 15	<i>For mounting direct on</i>	
	CTI 15, max. 16 mm <sup>2</sup> , CTT 25	047B3076
Bus bars for CTI 15	<i>For parallel connection fo CTI 15 in panel</i>	
	CTS 45-2 (2 x 45 mm)	047B3084
	CTS 45-3 (2 x 45 mm)	047B3096
	CTS 45-4 (2 x 45 mm)	047B3085
	CTS 45-5 (2 x 45 mm)	047B3086
	<i>For CTI 15 with auxiliary contact mounted on side</i>	
	CTS 54-2 (2 x 54 mm)	047B3087
	CTS 54-3 (3 x 54 mm)	047B3097
	CTS 54-4 (4 x 54 mm)	047B3088
CTS 54-5 (5 x 54 mm)	047B3089	

**Plastic enclosures for circuit breakers/manual motor starters CTI 15 (IP55)**

Type <sup>1) 2)</sup>	Application	Pushbuttons	Knockouts	Code no.
BXI 55	CTI 15	Start-Stop/reset	4 Pg 16 / 4 Pg 21	047B3091

<sup>1)</sup> With neutral and earth terminals

<sup>2)</sup> The enclosure also leaves space for a shunt release or an undervoltage release

**Contact symbols and terminal markings**

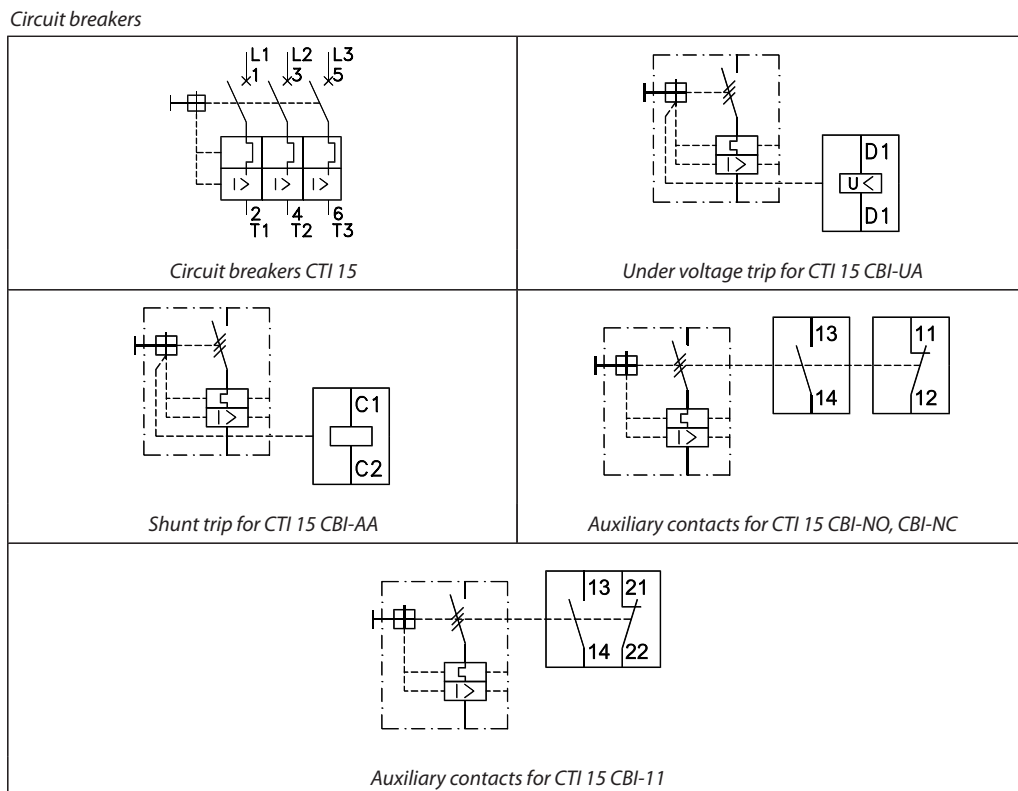

**Approvals**

Approval authority				
Product type	EN 60947	EAC	UL-listed USA	LLC CDC TYSK
CTI 15	•	•	•	•
CTS-	•	•	•	—
CTT 25	•	•	•	—
CBI-	•	•	•	—

• Approved

**General data**

Parameters		Type
		CTI 15
Isolation voltage	IEC, cULus	690 V
Pulse voltage		6 kV
Rated frequency range		40 – 60 Hz
Ambient temperature	Storage/transport	-25 °C – 80 °C
	Operation	-25 °C – 60 °C
Temperature compensated		-20 °C – 60 °C
Weather resistance	(IEC 68) Temp. / rel. humidity	40 °C, 92% RH: 56 days
	Temperate climate	23 °C, 83% RH/40 °C, 93% RH
Vibration (IEC 68) (all directions)		>7,5 g, 10 – 150 Hz
Shock (IEC 68-2-27)		30 g, 20 ms
Degree of protection		IP20
Installation orientation		Any direction
Rated current		0.25 – 16 A
Release range		9
Differential release		no
Magnetic trip (I <sub>eF</sub> max. = setting range max. value)		11 x I <sub>eF</sub> max
No. of operations per hour		30
Mechanical life (operations)		100.000
Electrical life (operations)		50.000
Release time on short-circuiting		2 ms
Power loss, typical		7 W

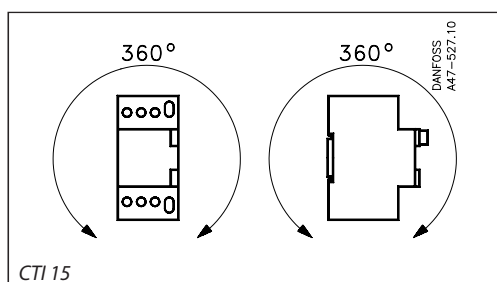
**Mounting direction**

**Max. motor load  
AC-2 and AC-3 operation**

The table contains kW values of rated motor sizes according to IEC 60072 which fits to the current range of the circuit breaker.

Sometimes more than one rated current fits to the range. In such cases both values are given and they are valid for AC-2 as well as for AC-3.

Type	Setting range [A]	Motor on operating voltage - Rated output in kW							
		230 – 240 V		400 – 415 V		500 V		690 V	
		[kW]	[kW]	[kW]	[kW]	[kW]	[kW]	[kW]	[kW]
CTI 15	0.25 – 0.4	–	–	0.09	0.12	–	–	–	–
	0.4 – 0.63	0.06	0.09	0.12	0.18	0.18	0.25	0.25	0.37
	0.63 – 1.0	0.12	0.18	0.18	0.25	0.25	0.37	0.37	0.55
	1.0 – 1.6	0.18	0.25	0.37	0.55	0.55	0.75	0.75	1.1
	1.6 – 2.5	0.37	0.55	0.75	1.1	1.1		1.5	1.8
	2.5 – 4.0	0.55	0.75	1.1	1.8	1.5	2.2	2.2	3.0
	4.0 – 6.3	1.1	1.5	1.8	3.0	3.0	3.7	3.7	4.0
	6.3 – 10	1.8	2.2	3.0	4.0	3.7	6.3	5.5	7.5
10 – 16	3.0	4.0	5.5	7.5	6.3	10	10	13	

Accessories for circuit breaker CTI 15

Max. load on supply block, current limiter, connection terminal and bus bar.

Type	Application	Description	Thermal current I <sub>th</sub>	Voltage supply
			[A]	[V]
CTT 25	CTI 15	Connection terminal	63	690
CTS-		Bus bars	63	690

**Accessories for circuit breakers**
*Loads on auxiliary contact blocks*

Type	Application	Description	I <sub>th</sub>		Load [A]							
					AC-15				DC-13			
			40 °C	60 °C	220 – 240 V	380 – 415 V	500 V	690 V	24 V	48 V	110 V	220 V
CBI-NO/NC	CTI 15	Auxiliary contact for building in	6	4	2	1	0.8	0.5	2	0.6	0.2	0.1
CBI-11		Auxiliary contact for building on (force-actuated PLC-compatible H contact)	10	6	2	1	0.8	0.5	2	0.6	0.2	0.1

*Power consumption, undervoltage and shunt trip*

Type	Application	Description		
CBI-UA	CTI 15	Undervoltage trip for building on	Rated control voltage U <sub>s</sub>	
			24 – 380 V / 50 Hz, 28 – 440 V / 60 Hz	
CBI-AA	CTI 15	Shunt trip for building on	Function voltage	
			0.35 – 0.7 x U <sub>s</sub> 100% make, max. 1.2 U <sub>s</sub>	
CBI-AA	CTI 15	Shunt trip for building on	Coil consumption	
			Make: 5 VA, 6 W Holding: 3 VA, 1.2 W	

*Terminations*

Type	Application	Comments	Terminals		Single and multi core [mm <sup>2</sup> ]	High capacity [mm <sup>2</sup> ]	Tightening torque [Nm]
			1-3-5	2-4-6			
CTI 15	CTI 15	Circuit breaker 16 A	•	•	1 – 6	1 – 4	2.5
CBI-NO/NC		Auxiliary contacts for CTI 15	–	–	0.75 – 4	0.75 – 2.5	2.5
CBI-11		Auxiliary contacts for CTI 15	–	–	0.75 – 4	0.75 – 2.5	2.5
CBI-AA		Shunt release for CTI 15	–	–	0.75 – 4	0.75 – 2.5	2.5
CBI-UA		Undervoltage release for CTI 15	–	–	0.75 – 4	0.75 – 2.5	2.5
CTT 25		Connection block for CTI 15	•	•	6 – 25	4 – 16	4

**UL/CSA-approved loads**

Type	Setting range [A]	Motor load in hp (AC-3)					
		1-phase operation			3-phase operation		
		115 V	230 V	200 V	230 V	460 V	575 V
CTI 15	0.63 – 1.0	–	–	–	–	1/2	3/4
	1.0 – 1.6	–	1/10	1/10	–	1	1
	1.6 – 2.5	1/10	1/6	1/6	3/4	1.5	2
	2.5 – 4	1/8	1/3	1/3	1	3	3
	4 – 6.3	1/4	3/4	3/4	2	5	5
	6.3 – 10	1/2	1.5	1.5	3	7.5	10
	10 – 16	1	3	3	5	10	15

*Terminations UL/CSA*

Type	Application	Comments	Terminals		Single and multi core [AWG]	Tightening torque [lb-in]
			1-3-5	2-4-6		
CTI 15	CTI 15	Circuit breaker 16 A	•	•	16 – 12	20 – 26
CBI-NO/NC		Auxiliary contacts for CTI 15	–	–	18 – 14	20 – 26
CBI-11		Auxiliary contacts for CTI 15	–	–	18 – 14	20 – 26
CBI-AA		Shunt release for CTI 15	–	–	18 – 14	20 – 26
CBI-UA		Undervoltage release for CTI 15	–	–	18 – 14	20 – 26
CTT 25		Connection block for CTI 15	•	–	14 – 6	36

*UL/CSA approved loads*

Type	Application	Description	Load	
			AC	DC
CBI-NO/NC	CTI 15	Auxiliary contact for building in	Standard pilot duty B600	Light pilot duty R300
CBI-11		Auxiliary contact for building in		

**Short circuit protection**

Short circuit coordination is the connection between the specifications of the protection devices, such as fuses, circuit breakers, MCCB and its ability to resist short circuit.

**Short circuit coordination type 1**

Test demand

O-t-CO

O = Breaking a short circuiting

CO = Making and breaking a short circuiting

t = Defined pause (3 min)

No damage to equipment or personal injury may occur in the event of short circuit. However, contactors and thermal overload relays are not required to remain functional after short circuit.

Typically the maximum short circuit breaking capacity  $I_{CU}$  is in use when a plant is dimensioned according to coordination type 1.

**Short circuit coordination type 2**

Test demand

O-t-CO-t-CO

O = Breaking a short circuiting

CO = Making and breaking a short circuiting

t = Defined pause (3 min)

t = Defined pause (3 min)

No damage to equipment or personal injury may occur in the event of short circuit. However, light contact welding is permissible, provided that contacts can be separated without deformation, using a screwdriver for example. Contactors and thermal overload relays must remain completely functional after short circuit. Typically the short circuit breaking capacity during operation  $I_{CS}$  is in use when a plant is dimensioned according to coordination type 2.

Terms	Remarks
Prospective short circuit current ( $I_{cc}$ )	The prospective short circuit current is the current that flows during a bolt short circuiting without any short circuit protection device mounted.
Rated service short circuit breaking capacity ( $I_{cu}$ )	The ultimate short circuit breaking capacity is the maximum short circuit current specified by the manufacturer that a circuit breaker can handle under circumstances specified in IEC 947-2 and in EN 60947-2
Rated service short circuit breaking capacity ( $I_{cs}$ )	The rated service short circuit breaking capacity is the maximum short circuit current specified by the manufacturer that a circuit breaker can handle under circumstances specified in IEC 947-2 and in EN 60947-2
"r"-current	The "r"-current is a short circuit test current. The size of the "r"-current is determined by the nominal current of the product. (See below)
$I_q$ current	$I_q$ -current is the maximum prospective short circuiting current stated by the manufacturer and often at the value 50 kA.
gL fuse	Indicates full short circuit protection at voltages 250 V, 400 V, 500 V and 690 V.
gL fuse	Indicates full short circuit protection of wires.
gG fuse	Indicates full short circuit protection at general applications. (Will replace gL- and gL-fuses)
T fuse	Description of an English standard fuse.
BS 88	British Standard for smeltesikringer

Contactor size	Prospective short circuit test current
Rated current at AC-3 load	"r" in kA
$0 < I_e < 16$	1
$16 < I_e < 63$	3
$63 < I_e < 125$	5
$125 < I_e < 315$	10
$315 < I_e < 630$	18
$630 < I_e < 1000$	30

*Fuses*

Type	Setting range	Fuses gI, aM, gL, gG and BS 88 type T when $I_{cc} > I_{cu}$			
	[A]	220 – 240 V	380 – 415 V	500 V	690 V
CTI 15	0.25 – 0.4				
	0.4 – 0.63				
	0.63 – 1.0				
	1.0 – 1.6				
	1.6 – 2.5				25
	2.5 – 4.0				35
	4.0 – 6.3			63	–
	6.3 – 10.0		63	50	–
	10.0 – 16.0	50	50	50	–

= Short-circuit-proof without fuse

**Rated short-circuit breaking capacity  $I_{cn}$** 
*Circuit breaker*

Type	Thermal overload relay Setting range	Magnetic trip Release current	Breaking capacity $I_{cn}$ in kA							
			Short-circuit category $I_{cu}$ and $I_{cs}$ to IEC 947-2/EN 60947-2							
			220 – 240 V		380 – 415 V		500 V		690 V	
[A]	[A]	$I_{cu}$	$I_{cs}$	$I_{cu}$	$I_{cs}$	$I_{cu}$	$I_{cs}$	$I_{cu}$	$I_{cs}$	
CTI 15	0.25 – 0.4	4.4	65	65	65	65	50	50	50	50
	0.4 – 0.63	6.9	65	65	65	65	50	50	50	50
	0.63 – 1.0	11	65	65	65	65	50	50	50	50
	1.0 – 1.6	18	65	65	65	65	50	50	50	50
	1.6 – 2.5	28	50	50	50	50	50	50	4.5	4.5
	2.5 – 4.0	44	50	50	10	10	6	3	2	2
	4.0 – 6.3	69	50	50	10	10	10	10	–	–
	6.3 – 10	110	50	50	10	10	4.5	4.5	–	–
	10 – 16	176	20	16	6	8	4.5	4.5	–	–

**Let-through graphs for circuit breaker CTI 15**

Maximum let-through energy  
Rated voltage 400 – 415 V

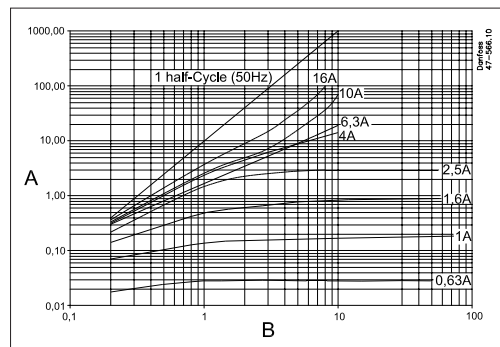

**A:** Max. let-through energy  $\int i^2 \times dt [10^3 \times A^2 \times s]$   
**B:** Prospective short-circuit current  $I_{cc} [kA]$

Maximum let-through current  
Rated voltage 400 – 415 V

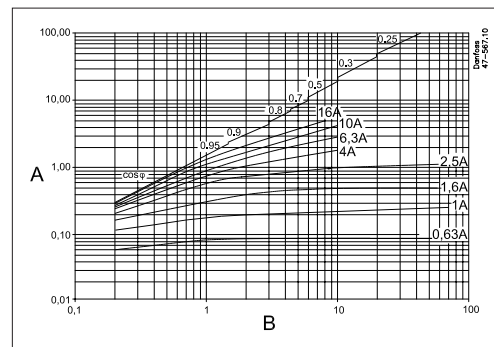

**A:** Max. let-through current  $I_D [kA]$   
**B:** Prospective short-circuit current  $I_{cc} [kA]$

The energy graph can be used to assess whether a lead is correctly protected against the thermal effect of a short-circuit current.

The graph can be read as follows:

If the expected short-circuit current at the point of installation is set at 8 kA, and a CTI 15 – 10 A is required, the let-through energy will be 40000 A<sup>2</sup>s.

*Calculation example:*

The following generally applies to leads subject to brief overload:

$$t = \left( \frac{k \times S}{I} \right)^2 \text{ which gives } I^2 \times t = k^2 \times S^2$$

Where  $t$  = duration of short-circuit current in seconds  
 $S$  = cross-section of lead in mm<sup>2</sup>  
 $I$  = short-circuit current in A<sub>eff</sub>  
 $k$  = a constant which for PVC-insulated Cu wire = 115

Thus, for a 1.5 mm<sup>2</sup> PVC-insulated Cu wire,  
 $I^2 \times t = (115 \times 1.5)^2 = 29756 \text{ A}^2\text{s}$ .

From the energy graph it can be seen that with  $I_{cc} = 8 \text{ kA}$  a CTI 15 with max. range setting = 10 A only allows about 20000 A<sup>2</sup>s through and therefore protects the lead satisfactorily.

The theoretical short-circuit current  $I_{cc}$  (prospective short-circuit current) is limited by CTI 15.  $I_D$  is the maximum let-through current (highest momentary value of the limited short-circuit current). This value is given in the graph as a function of the prospective short-circuit current.

The graphs have been plotted for eight different CTI 15 ranges.

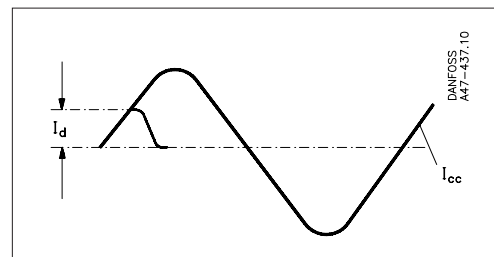



**Short-circuit protection of wiring**

Type	Max. setting	Protected min. cross-section [mm <sup>2</sup> ] at 380 / 415 V, 50 Hz					
		6	4	2.5	1.5	1	0.75
CTI 15	4.0	•	•	•	•	•	•
	6.3	•	•	•	•	•	•
	10.0	•	•	•	•	•	
	16.0	•	•	•	•		

Protection of PVC-insulated wires against overload and short-circuiting, in accordance with IEC 364 and CENELEC harmonizing documents 384-3 and 384-4.

Overload protection is given by the adjustable thermal circuit breakers in CTI 15 motor starters. The highest possible release current is therefore significantly lower than with overload protection by fuses. The magnetic trips with fixed setting that rapidly open the main contacts take over protection in the event of short-circuiting. The low total release time ensures that heating generated in leads by short-circuiting is limited to a minimum.

Further information is contained in national regulations.

*Setting in short-circuit protection application*

In many cases, CTI 15 are used exclusively for short-circuit protection - overload protection being provided by thermal overload relays, e.g. in multi stage motors or star-delta starters with heavy start, and/or in reducing motor lead cross-section. Here, the current value can be set 20% higher than the operating current so that only the thermal overload relays release when overload occurs.

**Overload protection of motors**

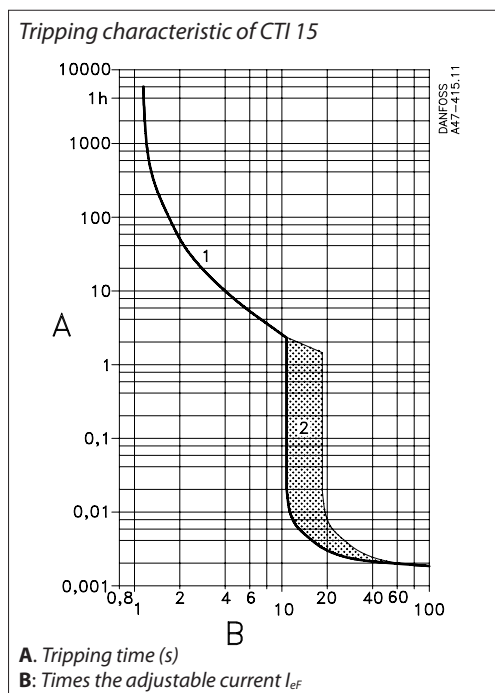

*1. Thermal tripping current*

The adjustable, current-dependent, delayed bimetal breakers guarantee motor overload protection. The graph gives the average value at 20 °C ambient temperature, from the cold condition. When the unit has warmed up, the release time is less or equal to the release time in the cold condition. The accurate adjustment ensures motor protection even in the event of phase failure.

*2. Magnetic tripping current*

The electromagnetic, instantaneous high-speed trips react at a fixed response current. At the highest setting value this corresponds to 11 times the set current for CTI 15. At a lower setting it is correspondingly higher.

**Short-circuit protection**

It has become more and more general to short-circuit-protect panels with circuit breakers rather than fuses. The clear advantages of "fuse-free" installations are:

- Space saving
- Cut-out in all three phases in the event of short-circuiting.
- No problems with non-convertible fuse types when exporting electrical equipment.

Danfoss circuit breakers CTI 15 conform to IEC 947-2 and are tested in accordance with EN 60947-2. Because of their fast reaction times and reliability they are particularly suitable for the short-circuit protection of panels.

**Fuseless coordination tables**

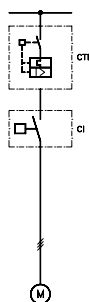

**Circuit breakers and contactors**

Prospective short circuit current:  $I_q = 10/50 \text{ kA}$   
 Voltage: 380 – 415 V/ 50 Hz  
 Overload and short circuit protection with circuit breaker type: CTI  
 Short circuit coordination: T1

Contactor type	Short circuit coordination type	
	T1	
	Test current "r" <sup>1)</sup> and $I_q = 50 \text{ kA}$	
	Maximum CTI - range [A]	
CI 5-2, CI 5-5, CI 5-9	16 <sup>2)</sup>	
CI 6, CI 9	16 <sup>2)</sup>	
CI 12, CI 15	16 <sup>2)</sup>	
CI 16	16 <sup>2)</sup>	
CI 20, CI 25	16 <sup>2)</sup>	

<sup>1)</sup> Short circuit test current according to EN 60947-4 (see table page 8)  
<sup>2)</sup> Fuses should be installed in the front of CTI 15 with higher ratings than 6.3 A when rated service breaking capacity exceed values in tables page 9

**Fuseless coordination tables**

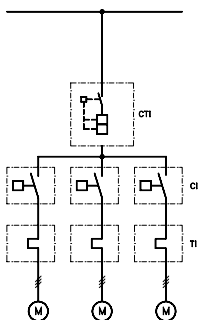

**Circuit breakers, contactors and thermal overload relays (several groups)**

Prospective short circuit current:  $I_q = 50 \text{ kA}$   
 Voltage: 380 – 415 V / 50 Hz  
 Overload protection with thermal overload relay type: TI  
 Short circuit protection with circuit breaker type: CTI  
 Short circuit coordination: T1

Contactor type	Thermal overload relay Range	Test current "r" <sup>1)</sup> and $I_q = 50 \text{ kA}$
	[A]	Maximum CTI - range [A]
CI 5-5, CI 6, CI 9	0.13 – 0.20	CTI 15 – 16 A <sup>2)</sup>
CI 5-5, CI 6, CI 9	0.19 – 0.29	
CI 5-5, CI 6, CI 9	0.27 – 0.42	
CI 5-5, CI 6, CI 9	0.4 – 0.62	
CI 5-5, CI 6, CI 9	0.6 – 0.92	
CI 5-5, CI 6, CI 9	0.85 – 1.3	CTI 15 – 16 A <sup>2)</sup>
CI 5-5, CI 6, CI 9	1.2 – 1.9	
CI 5-5, CI 6, CI 9	1.8 – 2.8	
CI 5-5, CI 6, CI 9	2.7 – 4.2	
CI 5-5, CI 6, CI 9	4 – 6.2	
CI 5-9, CI 9	6 – 9.2	CTI 15 – 16 A <sup>2)</sup>
CI 12, CI 15	8 – 12	
CI 15, CI 16	11 – 16	

<sup>1)</sup> Short circuit test current according to EN 60947-4 (see table page 8)  
<sup>2)</sup> Fuses should be installed in the front of CTI 15 with higher ratings than 6.3 A when rated service breaking capacity exceed values in tables page 9.

**Coordination tables with fuses** Contactors

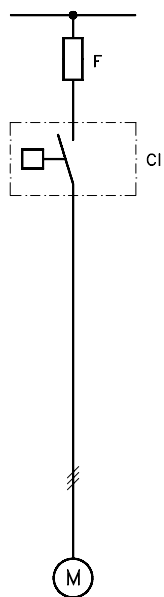

Prospective short circuit current:

$I_q = 10/ 50 \text{ kA}$

Voltage:

380 – 415 V/ 50 Hz

Overload and short circuit protection with fuse types:

gI, gL, gG and 'T' (BS 88)

Short circuit coordination:

T1

Contactor type	Short circuit coordination type	
	T1	
	Test Current	
	"r" <sup>1)</sup> and $I_q = 50 \text{ kA}$	
	gI,gL,gG [A]	'T' [A]
CI 5-2, CI 5-5, CI 5-9	50	63
CI 6, CI 9, CI 12, CI 15	50	63
CI 16	80	80
CI 20, CI 25	80	80
CI 30	80	80
CI 32	125	125
CI 37, CI 45, CI 50	125	125
CI 61, CI 73	250	
CI 141	315	
CI 180	355	
CI 210 EI, CI 250 EI	500	
CI 300 EI, CI 420 EI	630	

<sup>1)</sup> Short circuit test current according to EN 60947-4 (see table page 7)

Coordination tables with fuses

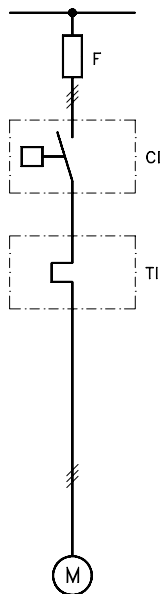

Contactors

Prospective short circuit current:

Voltage:

Overload and short circuit protection with fuse types:

Short circuit coordination:

$I_q = 10/ 50 \text{ kA}$

380 – 415 V/ 50 Hz

gI, gL, gG and 'T' (BS 88)

T1

Contactor type	Thermal overload relay	Short circuit coordination type	
		T1	
		Test Current	
		"r" <sup>1)</sup> and $I_q = 50 \text{ kA}$	
	[A]	gI, gL, gG [A]	'T' [A]
CI 5-5, CI 5-9, CI 6, CI 9	0.13 – 0.20	25	32
CI 5-5, CI 5-9, CI 6, CI 9	0.19 – 0.29	25	32
CI 5-5, CI 5-9, CI 6, CI 9	0.27 – 0.42	25	32
CI 5-5, CI 5-9, CI 6, CI 9	0.42 – 0.60	25	32
CI 5-5, CI 5-9, CI 6, CI 9	0.60 – 0.92	25	32
CI 5-5, CI 5-9, CI 6, CI 9	0.85 – 1.3	25	32
CI 5-5, CI 5-9, CI 6, CI 9	1.2 – 1.9	25	32
CI 5-5, CI 5-9, CI 6, CI 9	1.8 – 2.8	25	32
CI 5-5, CI 5-9, CI 6, CI 9	2.7 – 4.2	25	32
CI 5-5, CI 5-9, CI 6, CI 9	4 – 6.2	35	40
CI 5-9, CI 9	6 – 9.2	0	50
CI 12, CI 15	8 – 12	63	63
CI 15, CI 16	11 – 16	80	80
CI 16, CI 20	15 – 20	80	80
CI 25	19 – 25	80	80
CI 30	24 – 32	80	80
CI 32	16 – 23	125	125
CI 32	22 – 32	125	125
CI 37, CI 45	30 – 45	125	125
CI 50	42 – 63	125	125
CI 61	42 – 63		100
CI 73	60 – 80		125
CI 86	74 – 85		125
CI 140	20 – 180	315	
CI 180	20 – 180	355	
CI 210 EI	160 – 630	500	
CI 300 EI	160 – 630	630	

<sup>1)</sup> Short circuit test current according to EN 60947-4 (see table page 7)

**Coordination tables with fuses or circuit breakers/MCB**

**Auxiliary contacts**

Prospective short circuit current:  
Coordination type:  
Fuse types:

$I_q = 1 \text{ kA}$   
"weld-free"  
gI, gL, gG and 'T' (BS 88)

For unit type	Auxiliary contacts		Build-in	Max. permissible fuse		MCCB	
	Clip-on			gI, gL, gG	'T'	Let-through energy	Max. CTI-range
			[A]	[A]	[A <sup>2</sup> s]	[A]	
CI 6			•	10	16	400	2
CI 5-2, CI 5-5, CI 5-9	CBM-			10	16	400	2
			•	16	20	900	4
CI 6, CI 9, CI 12, CI 15		S		6	10	130	1
CI 16, CI 20, CI 25, CI 30	CB-	NO-NC		16	20	900	4
CI 32, CI 37, CI 45, CI 50		EM-LB		25	32	3000	25
CI 61, CI 73, CI 86	CBD -			10	16	400	2
			•	25	32	3000	25
CI 141, CI 180	CBC -		•	16	20	900	4
CTI 15	CBI -			16	20	900	4

**Dimensions  
Circuit breakers CTI**

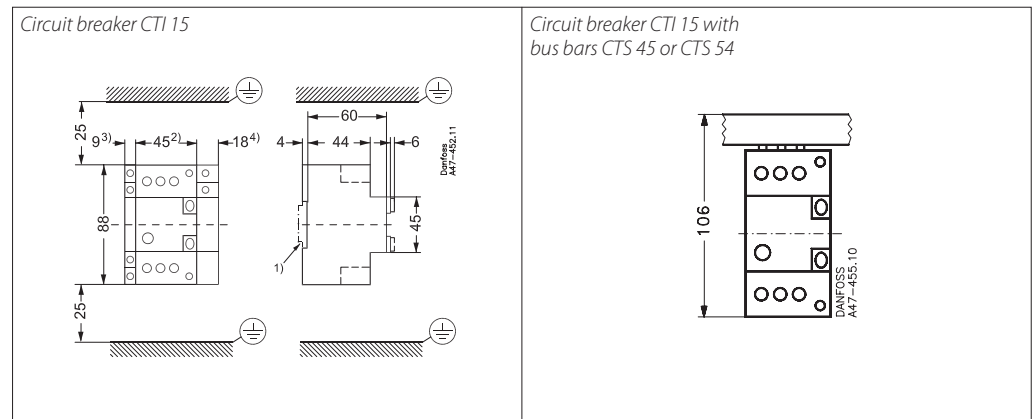

- 1) Possibility of fixing on DIN rail EN 50022-35
- 2) Circuit breaker CTI 15, incl. auxiliary contact block CBI for building in
- 3) Auxiliary contact block CBI for mounting
- 4) Shunt release CBI-AA or undervoltage release CBI-UA

## X-ON Electronics

Largest Supplier of Electrical and Electronic Components

*Click to view similar products for [Circuit Breaker Accessories](#) category:*

*Click to view products by [Danfoss](#) manufacturer:*

Other Similar products are found below :

[CSC-403PS](#) [8T1-D-11A](#) [B151-7184-L](#) [NEB10](#) [8C1-C-721](#) [8T1-E-115](#) [8T1-E-275](#) [8T1-E-278](#) [4-1393247-8](#) [4-1393247-9](#) [506-11315-001](#)  
[3803221](#) [3803231](#) [NEB6](#) [X10506BF](#) [NES](#) [9-1393249-0](#) [802-ESB50UL489](#) [3RV2011-1CA15](#) [607.5689.127](#) [30.329](#) [CA707/TS/01](#)  
[11-32-2733](#) [X10508BF](#) [X22261102](#) [975090700](#) [CX2.5/4/O](#) [975090701](#) [PS-2P](#) [Y30019003](#) [C-TEC1225 P](#) [PS-1006](#) [618.6335.069](#)  
[975455700](#) [BAC03](#) [930727103](#) [934097101](#) [ZG20-1](#) [934097100](#) [JX2.5/4](#) [KEM380CUL](#) [CC848756916](#) [JX2.5/6](#) [JX2.5/5](#) [HSP6/10U](#)  
[DMRBU BLACK BOX](#) [DB16/BU](#) [DB16/BL](#) [CM2.5S2](#) [973604100](#)