



5STF 23H2040

Fast Thyristor

Properties

- Amplifying gate
- High operational capability
- Optimized turn-off parameters

Applications

- Power switching applications

Key Parameters

V_{DRM}, V_{RRM}	= 2 000	V
I_{TAV}	= 2 322	A
I_{TSM}	= 42.0	kA
V_{TO}	= 1.516	V
r_T	= 0.111	m Ω
t_q	= 40	μ s

Types

	V_{RRM}, V_{DRM}
5STF 23H2040	2 000 V
Conditions: $T_j = -40 \div 125$ °C, half sine waveform, $f = 50$ Hz, note 1	

Mechanical Data

F_m	Mounting force	50 \pm 5 kN
m	Weight	0.93 kg
D_s	Surface creepage distance	36 mm
D_a	Air strike distance	15 mm

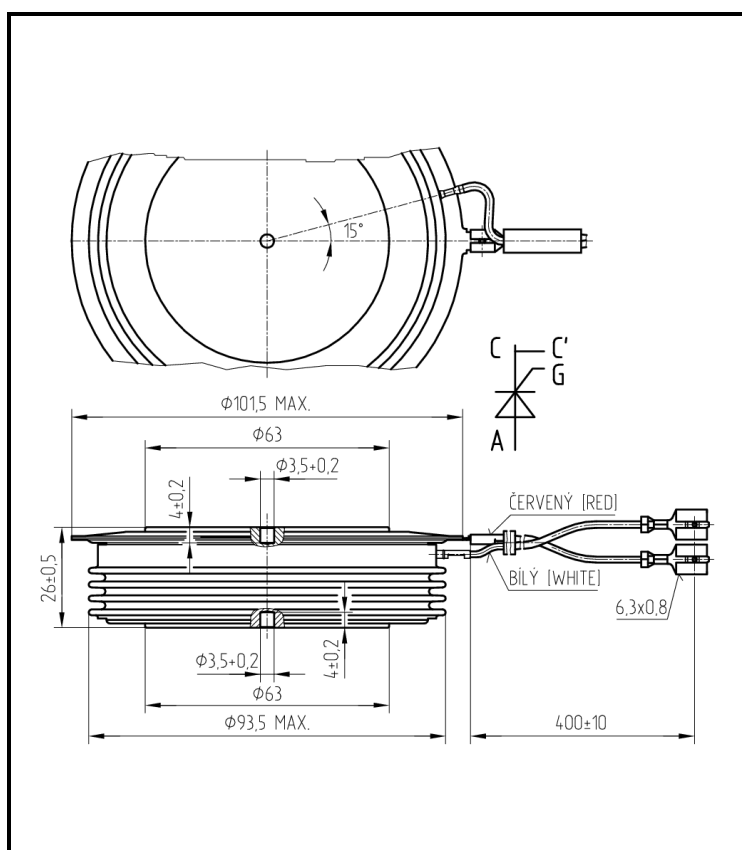

Fig. 1 Case



ABB s.r.o.

Novodvorska 1768/138a, 142 21 Praha 4, Czech Republic

tel.: +420 261 306 250, <http://www.abb.com/semiconductors>

Maximum Ratings		Maximum Limits	Unit
V_{RRM} V_{DRM}	Repetitive peak reverse and off-state voltage $T_j = -40 \div 125 \text{ }^\circ\text{C}$, note 1	2 000	V
I_{TRMS}	RMS on-state current $T_c = 70 \text{ }^\circ\text{C}$, half sine waveform, $f = 50 \text{ Hz}$	3 648	A
I_{TAVm}	Average on-state current $T_c = 70 \text{ }^\circ\text{C}$, half sine waveform, $f = 50 \text{ Hz}$	2 322	A
I_{TSM}	Peak non-repetitive surge half sine pulse, $V_R = 0 \text{ V}$	$t_p = 10 \text{ ms}$ 42 000 $t_p = 8.3 \text{ ms}$ 44 900	A
$\hat{P}t$	Limiting load integral half sine pulse, $V_R = 0 \text{ V}$	$t_p = 10 \text{ ms}$ 8 820 000 $t_p = 8.3 \text{ ms}$ 8 370 000	A²s
$(di_T/dt)_{cr}$	Critical rate of rise of on-state current $I_T = I_{TAVm}$, half sine waveform, $f = 50 \text{ Hz}$, $V_D = 2/3 V_{DRM}$, $t_r = 0.3 \text{ } \mu\text{s}$, $I_{GT} = 2 \text{ A}$	800	A/μs
$(dv_D/dt)_{cr}$	Critical rate of rise of off-state voltage $V_D = 2/3 V_{DRM}$	1 000	V/μs
P_{GAVm}	Maximum average gate power losses	3	W
I_{FGM}	Peak gate current	10	A
V_{FGM}	Peak gate voltage	12	V
V_{RGM}	Reverse peak gate voltage	10	V
$T_{jmin} - T_{jmax}$	Operating temperature range	-40 \div 125	$^\circ\text{C}$
$T_{stgmin} - T_{stgmax}$	Storage temperature range	-40 \div 125	$^\circ\text{C}$

Unless otherwise specified $T_j = 125 \text{ }^\circ\text{C}$

Note 1: De-rating factor of 0.13% V_{RRM} or V_{DRM} per $^\circ\text{C}$ is applicable for T_j below $25 \text{ }^\circ\text{C}$

Characteristics			Value			Unit
			min.	typ.	max.	
V_{TM}	Maximum peak on-state voltage	$I_{TM} = 2\,000\text{ A}$ $I_{TM} = 4\,000\text{ A}$			1.680 1.970	V
V_{T0}	Threshold voltage				1.516	V
r_T	Slope resistance				0.111	mΩ
	$I_{T1} = 3\,613\text{ A}$, $I_{T2} = 10\,838\text{ A}$					
I_{DM}	Peak off-state current				150	mA
	$V_D = V_{DRM}$					
I_{RM}	Peak reverse current				150	mA
	$V_R = V_{RRM}$					
t_{gd}	Delay time				2.0	μs
	$T_j = 25\text{ °C}$, $V_D = 0.4 V_{DRM}$, $I_{TM} = I_{TAVm}$, $t_r = 0.3\text{ μs}$, $I_{GT} = 2\text{ A}$					
t_{q1}	Turn-off time				40.0	μs
	$I_T = 1\,000\text{ A}$, $di_T/dt = -50\text{ A/μs}$, $V_R = 100\text{ V}$, $V_D = 2/3 V_{DRM}$, $dv_D/dt = 50\text{ V/μs}$					
t_{q2}	Turn-off time				60.0	μs
	$I_T = 1\,000\text{ A}$, $di_T/dt = -50\text{ A/μs}$, $V_R = 100\text{ V}$, $V_D = 0.8 V_{DRM}$, $dv_D/dt = 400\text{ V/μs}$					
Q_{rr}	Recovery charge				1200	μC
	the same conditions as at t_{q1}					
I_{rrM}	Reverse recovery current				290	A
	the same conditions as at t_{q1}					
I_H	Holding current	$T_j = 25\text{ °C}$ $T_j = 125\text{ °C}$			250 150	mA
I_L	Latching current	$T_j = 25\text{ °C}$ $T_j = 125\text{ °C}$			500 300	mA
V_{GT}	Gate trigger voltage	$T_j = -40\text{ °C}$ $T_j = 25\text{ °C}$ $T_j = 125\text{ °C}$			4 3 2	V
	$V_D = 12\text{ V}$, $I_T = 4\text{ A}$		0.25			
I_{GT}	Gate trigger current	$T_j = -40\text{ °C}$ $T_j = 25\text{ °C}$ $T_j = 125\text{ °C}$			1000 500 300	mA
	$V_D = 12\text{ V}$, $I_T = 4\text{ A}$		10			

Unless otherwise specified $T_j = 125\text{ °C}$

Thermal Parameters		Value	Unit
R_{thjc}	Thermal resistance junction to case <i>double side cooling</i>	10.0	K/kW
	<i>anode side cooling</i>	16.0	
	<i>cathode side cooling</i>	26.5	
R_{thch}	Thermal resistance case to heatsink <i>double side cooling</i>	3.0	K/kW
	<i>single side cooling</i>	6.0	

Transient Thermal Impedance						
Analytical function for transient thermal impedance $Z_{thjc} = \sum_{i=1}^5 R_i (1 - \exp(-t/\tau_i))$	i	1	2	3	4	5
	τ_i (s)	0.4871	0.1468	0.0677	0.0079	0.0021
	R_i (K/kW)	6.73	1.44	0.65	0.84	0.32
Conditions: $F_m = 50 \pm 5$ kN, Double side cooled						
Correction for periodic waveforms 180° sine: add 1.0 K/kW 180° rectangular: add 1.0 K/kW 120° rectangular: add 1.5 K/kW 60° rectangular: add 3.0 K/kW						
Fig. 2 <i>Dependence transient thermal impedance junction to case on square pulse</i>						

On-State Characteristics

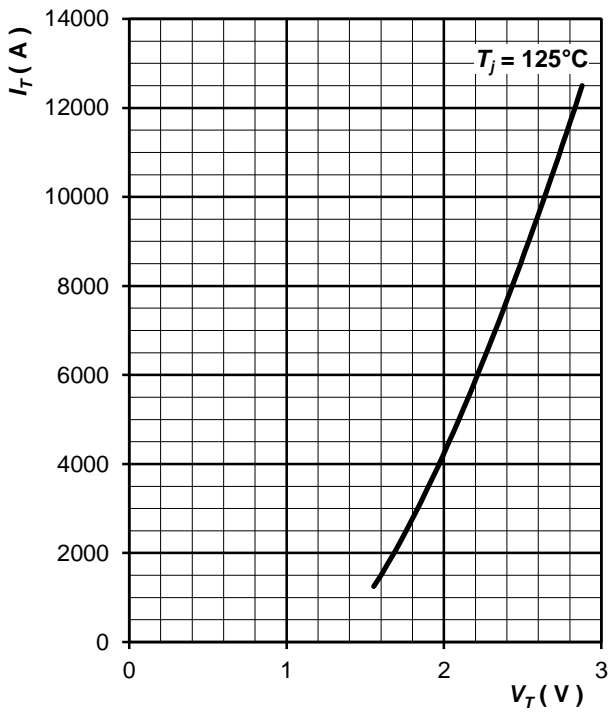

Fig. 3 Maximum on-state characteristics

Gate Trigger Characteristics

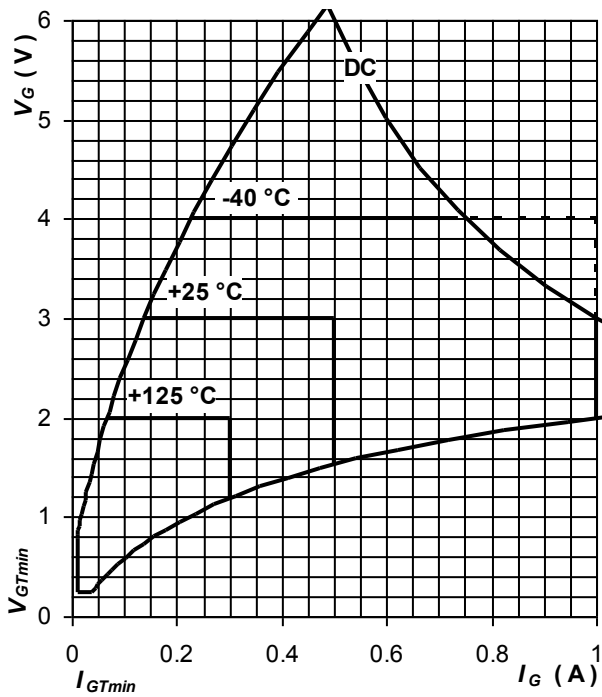

Fig. 4 Gate trigger characteristics

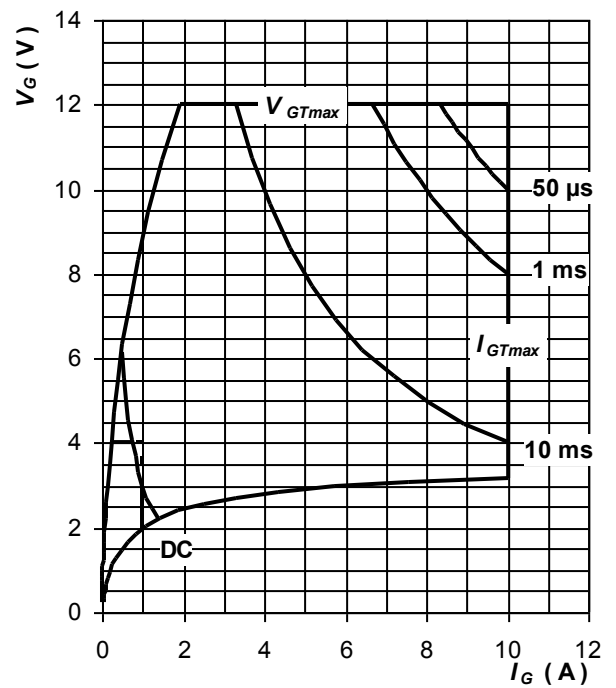

Fig. 5 Maximum peak gate power loss

Surge Characteristics

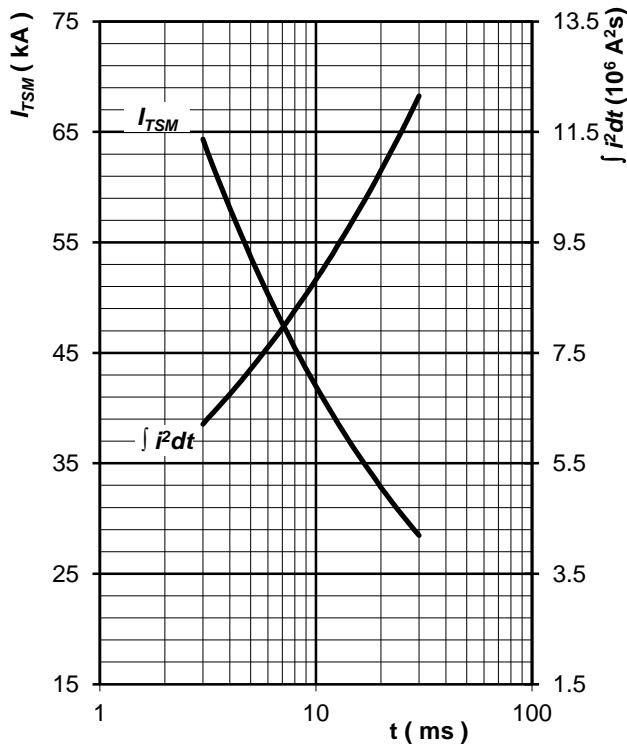

Fig. 6 Surge on-state current vs. pulse length, half sine wave, single pulse, $V_R = 0 V, T_j = T_{jmax}$

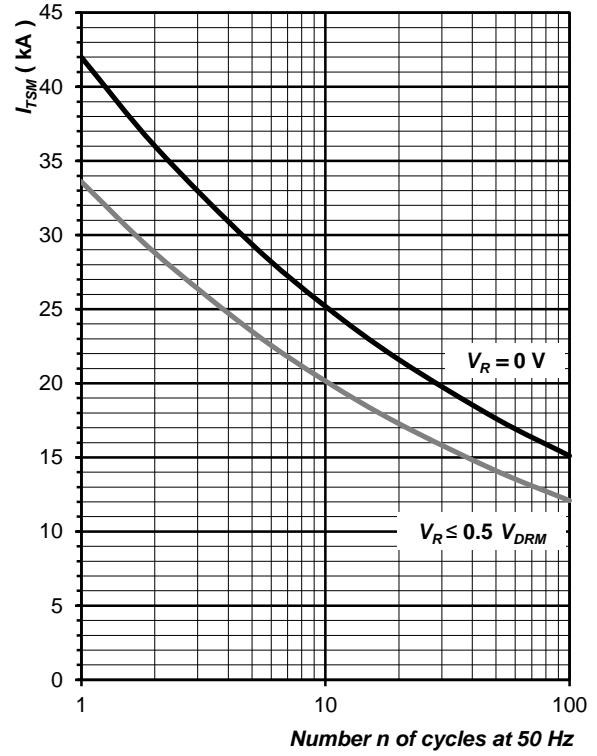

Fig. 7 Surge on-state current vs. number of pulses, half sine wave, $T_j = T_{jmax}$

Power Loss and Maximum Case Temperature Characteristics

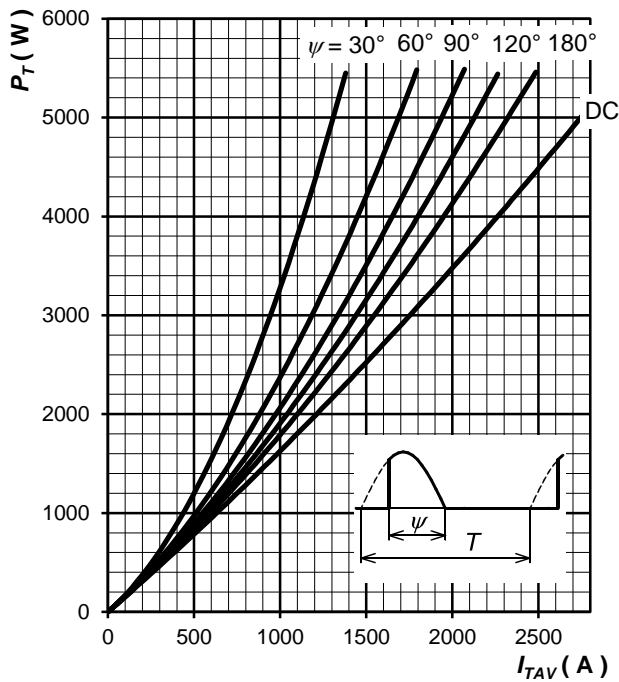

Fig. 8 On-state power loss vs. average on-state current, sine waveform, $f = 50 \text{ Hz}$, $T = 1/f$

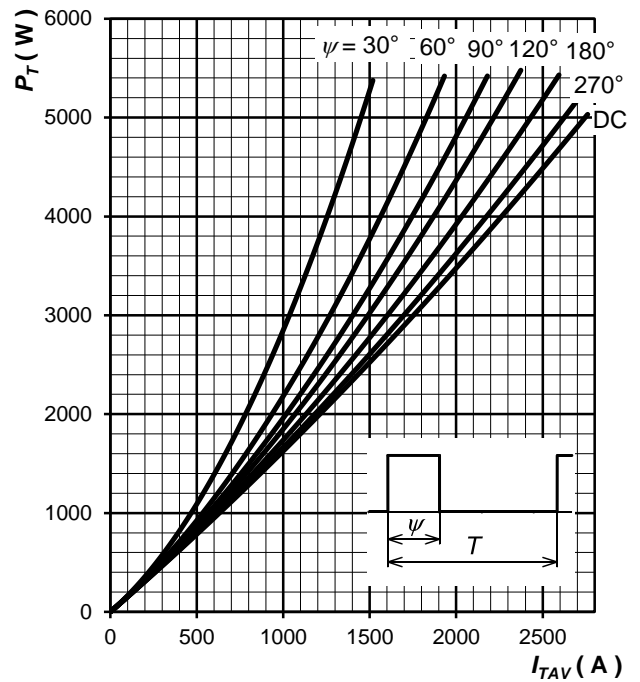

Fig. 9 On-state power loss vs. average on-state current, square waveform, $f = 50 \text{ Hz}$, $T = 1/f$

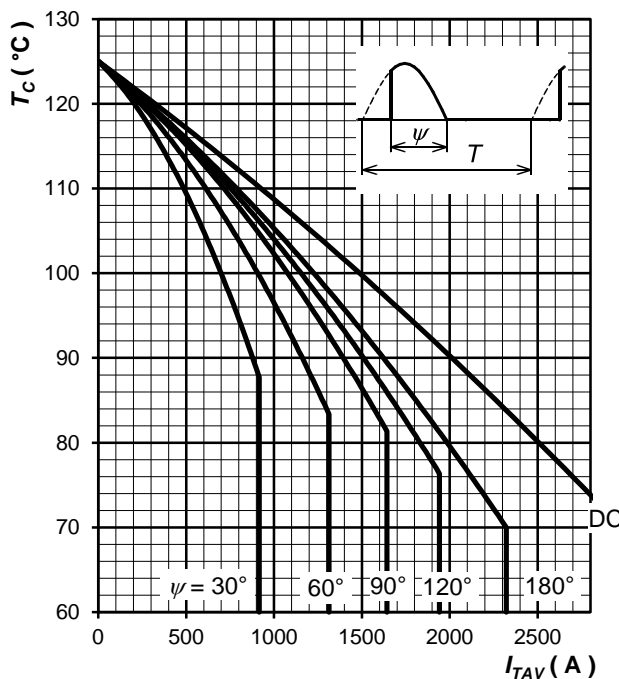

Fig. 10 Max. case temperature vs. aver. on-state current, sine waveform, $f = 50 \text{ Hz}$, $T = 1/f$

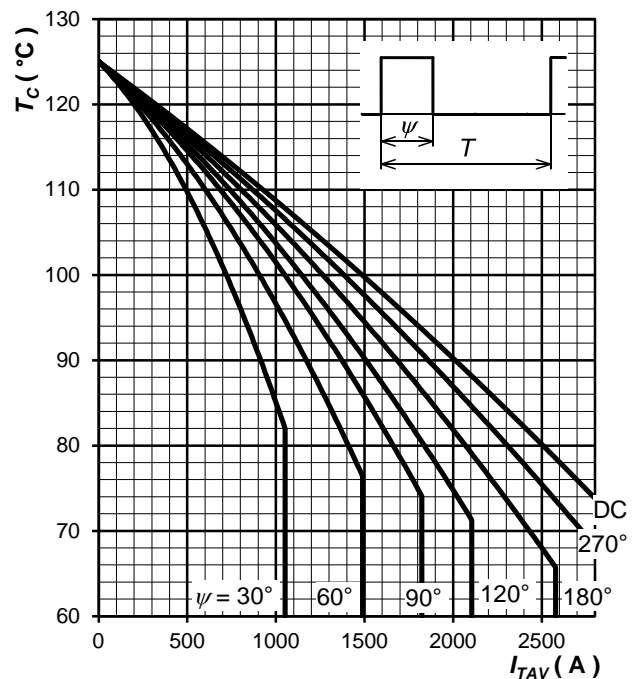

Fig. 11 Max. case temperature vs. aver. on-state current, square waveform, $f = 50 \text{ Hz}$, $T = 1/f$

Note 2: Figures number 8 ÷ 11 have been calculated without considering any turn-on and turn-off losses. They are valid for $f = 50$ or 60 Hz operation.

Turn-off Time, Parameter Relationship

Maximum values of turn-off time at application specific conditions are given by using this formula:

$$t_q = t_{q1} \cdot \frac{t_q}{t_{q1}}(T_j) \cdot \frac{t_q}{t_{q1}}(dv_D / dt) \cdot \frac{t_q}{t_{q1}}(-di_T / dt)$$

where:

t_{q1} is turn-off time at standard conditions, see section "Characteristics"

$\frac{t_q}{t_{q1}}(T_j)$ is factor to be taken from fig. 12

$\frac{t_q}{t_{q1}}(dv_D / dt)$ is factor to be taken from fig. 13

$\frac{t_q}{t_{q1}}(-di_T / dt)$ is factor to be taken from fig. 14

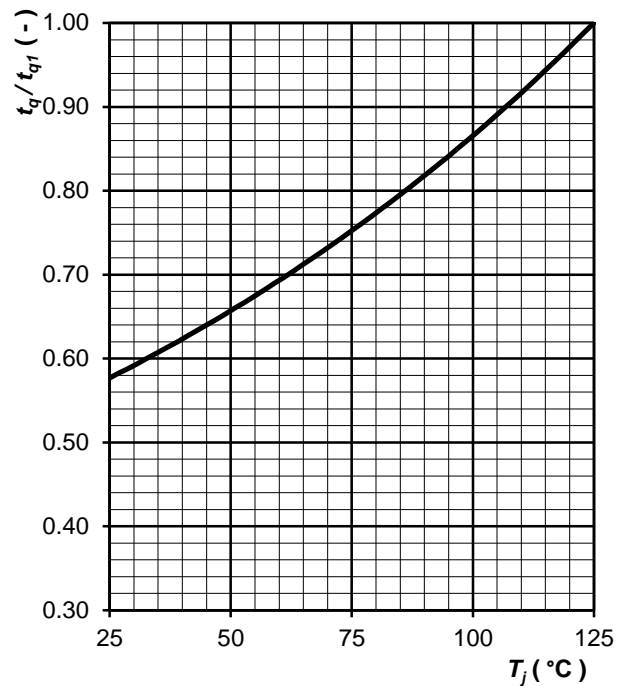

Fig. 12 Normalised maximum turn-off time vs. junction temperature

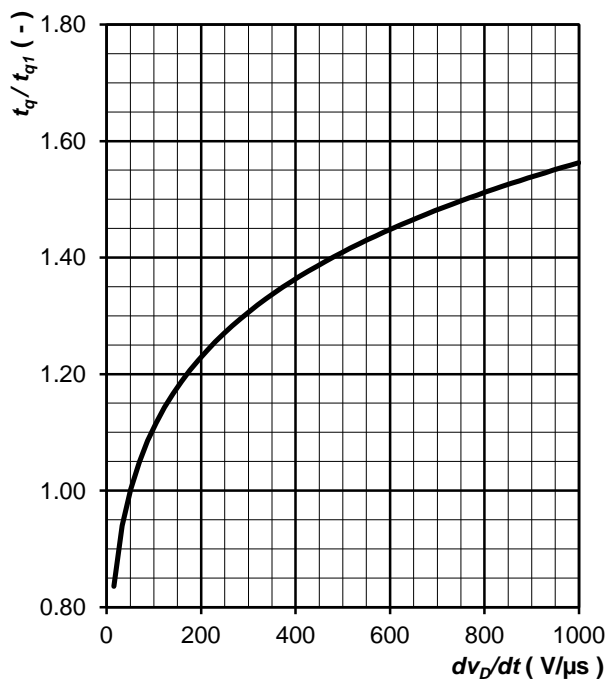

Fig. 13 Normalised maximum turn-off time vs. rate of rise of off-state voltage

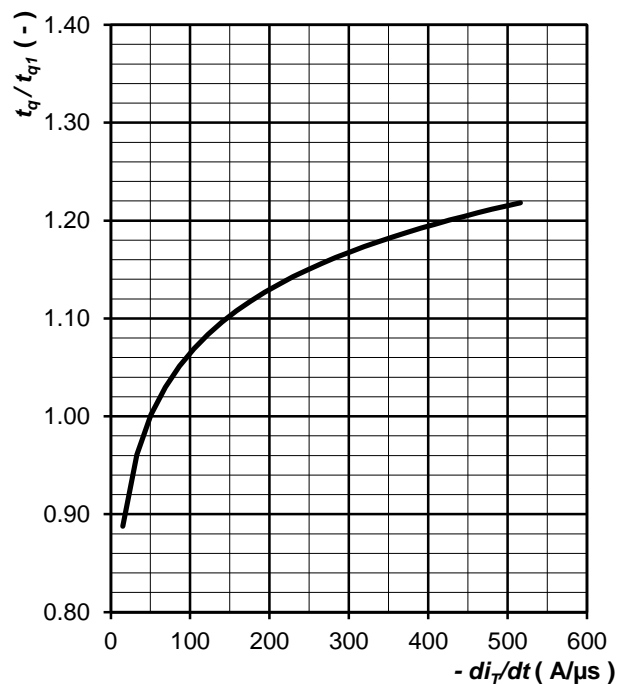

Fig. 14 Normalised maximum turn-off time vs. rate of fall of on-state current

Turn-off Characteristics

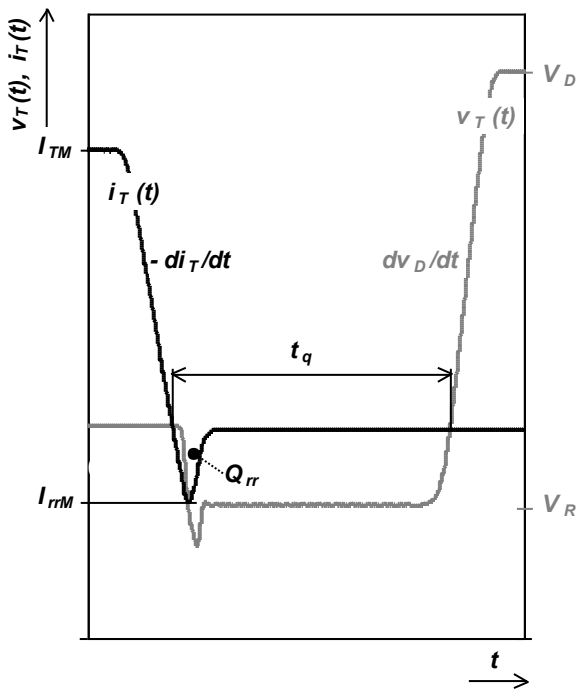

Fig. 17 Typical waveforms and definition of symbols at turn-off of a thyristor, inductive switching without RC snubber

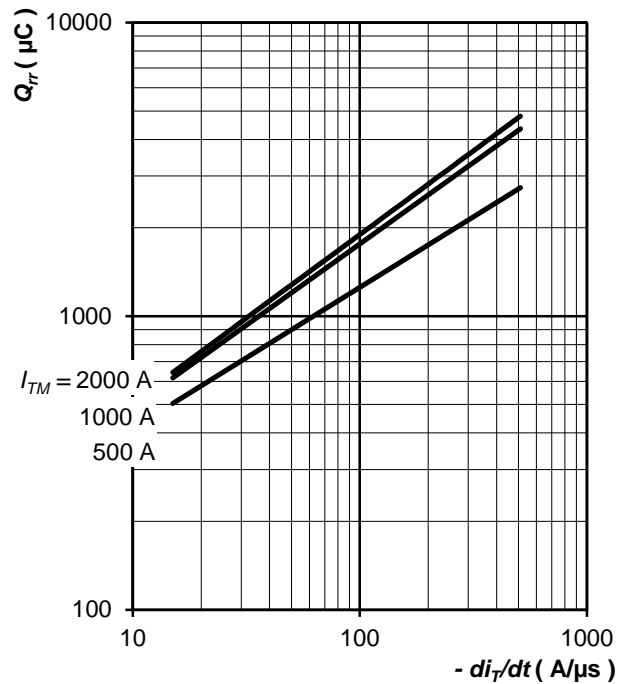

Fig. 18 Max. recovered charge vs. rate of fall on-state current, trapezoid pulse, $V_R = 100 \text{ V}$, $T_j = T_{jmax}$

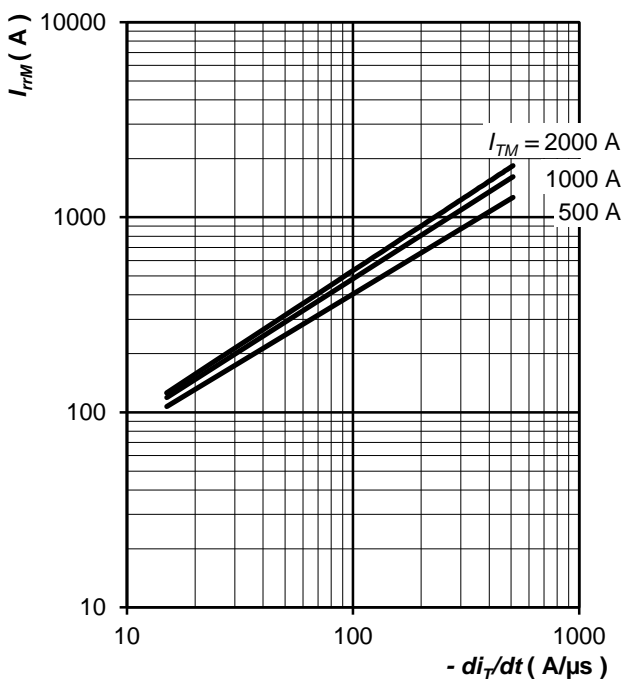

Fig. 19 Max. reverse recovery current vs. rate of fall on-state current, trapezoid pulse, $V_R = 100 \text{ V}$, $T_j = T_{jmax}$

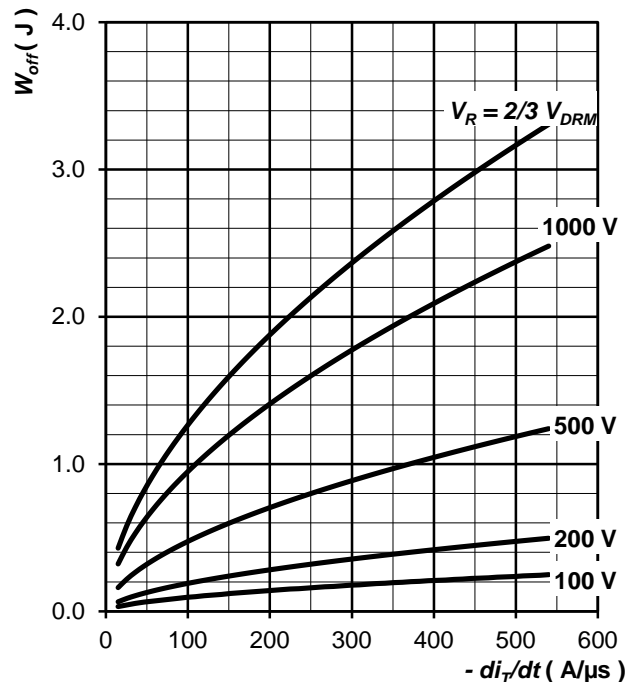

Fig. 20 Maximum turn-off energy per pulse vs. rate of fall on-state current, trapezoid pulse, inductive switching without RC snubber, $I_{TM} = 2\ 000 \text{ A}$, $T_j = T_{jmax}$

Notes:

ABB s.r.o., Novodvorska 1768/138a, 142 21 Praha 4, Czech Republic

ABB s.r.o. reserves the right to change the data contained herein at any time without notice

X-ON Electronics

Largest Supplier of Electrical and Electronic Components

Click to view similar products for [SCRs category](#):

Click to view products by [ABB manufacturer](#):

Other Similar products are found below :

[NTE5428](#) [NTE5448](#) [NTE5457](#) [NTE5511](#) [T1500N16TOF VT](#) [T720N18TOF](#) [T880N14TOF](#) [T880N16TOF](#) [TS110-7UF](#) [TT104N12KOF-A](#)
[TT104N12KOF-K](#) [TT162N16KOF-A](#) [TT162N16KOF-K](#) [TT330N16AOF](#) [VS-16RIA100](#) [VS-22RIA20](#) [VS-2N5206](#) [VS-2N685](#) [VS-](#)
[40TPS08A-M3](#) [VS-ST230S12P1VPBF](#) [057219R](#) [CLB30I1200HB](#) [T1190N16TOF VT](#) [T1220N22TOF VT](#) [T201N70TOH](#) [T830N18TOF](#)
[TD92N16KOF-A](#) [TT250N12KOF-K](#) [VS-2N692](#) [VS-2N689](#) [VS-25RIA40](#) [VS-16RIA120](#) [VS-10RIA120](#) [VS-30TPS08PBF](#) [NTE5427](#)
[NTE5442](#) [VS-2N690](#) [VS-ST300S20P0PBF](#) [TT251N16KOF-K](#) [VS-22RIA100](#) [VS-16RIA40](#) [CR02AM-8#F00](#) [TD250N16KOF-A](#) [VS-](#)
[ST110S16P0](#) [VS-10RIA10](#) [VS-16TTS08-M3](#) [TS110-7A1-AP](#) [T930N36TOF VT](#) [T2160N24TOF VT](#) [T1190N18TOF VT](#)