

74LV03

Quad 2-input NAND gate

Rev. 4 — 31 August 2017

Product data sheet

1 General description

The 74LV03 is a low-voltage Si-gate CMOS device and is pin and function compatible with 74HC/HCT03.

The 74LV03 provides the 2-input NAND function.

The 74LV03 has open-drain N-transistor outputs, which are not clamped by a diode connected to V_{CC} . In the OFF-state, i.e., when one input is LOW, the output may be pulled to any voltage between GND and $V_{O(max)}$. This allows the device to be used as a LOW-to-HIGH or HIGH-to-LOW level shifter. For digital operation and OR-tied output applications, these devices must have a pull-up resistor to establish a logic HIGH level.

2 Features and benefits

- Wide operating voltage: 1.0 V to 5.5 V
- Optimized for low voltage applications: 1.0 V to 3.6 V
- Accepts TTL input levels between $V_{CC} = 2.7$ V and $V_{CC} = 3.6$ V
- Typical V_{OLP} (output ground bounce) < 0.8 V @ $V_{CC} = 3.3$ V, $T_{amb} = 25$ °C
- Typical V_{OHV} (output V_{OH} undershoot) > 2 V @ $V_{CC} = 3.3$ V, $T_{amb} = 25$ °C
- Level shifter capability
- ESD protection:
 - HBM JESD22-A114F exceeds 2000 V
 - MM JESD22-A115-A exceeds 200 V
- Specified from -40 °C to +85 °C and from -40 °C to +125 °C

3 Ordering information

Table 1. Ordering information

Type number	Package			
	Temperature range	Name	Description	Version
74LV03D	-40 °C to + 125 °C	SO14	plastic small outline package; 14 leads; body width 3.9 mm	SOT108-1

4 Functional diagram

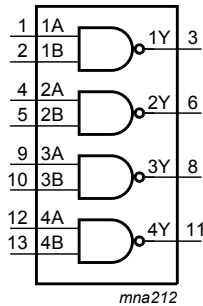

Figure 1. Logic symbol

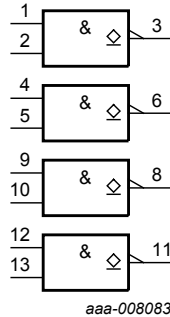

Figure 2. IEC logic symbol

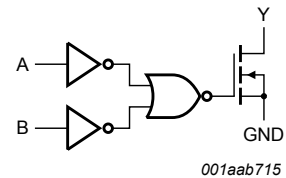

Figure 3. Logic diagram (one gate)

5 Pinning information

5.1 Pinning

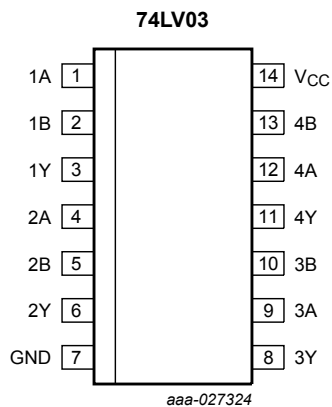

Figure 4. Pin configuration SO14

5.2 Pin description

Table 2. Pin description

Symbol	Pin	Description
1A, 2A, 3A, 4A	1, 4, 9, 12	data input
1B, 2B, 3B, 4B	2, 5, 10, 13	data input
1Y, 2Y, 3Y, 4Y	3, 6, 8, 11	data output
GND	7	ground (0 V)
V _{CC}	14	supply voltage

6 Functional description

Table 3. Function table ^[1]

Input		Output
nA	nB	nY
L	L	Z
L	H	Z
H	L	Z
H	H	L

- [1] H = HIGH voltage level;
L = LOW voltage level;
Z = high-impedance OFF-state.

7 Limiting values

Table 4. Limiting values

In accordance with the Absolute Maximum Rating System (IEC 60134). Voltages are referenced to GND (ground = 0 V).

Symbol	Parameter	Conditions	Min	Max	Unit
V_{CC}	supply voltage		-0.5	+7.0	V
I_{IK}	input clamping current	$V_I < -0.5\text{ V}$ or $V_I > V_{CC} + 0.5\text{ V}$ ^[1]	-	±20	mA
I_{OK}	output clamping current	$V_O < -0.5\text{ V}$ or $V_O > V_{CC} + 0.5\text{ V}$ ^[1]	-	±50	mA
I_O	output current	$V_O = -0.5\text{ V}$ to $(V_{CC} + 0.5\text{ V})$	-	±25	mA
I_{CC}	supply current		-	50	mA
I_{GND}	ground current		-50	-	mA
T_{stg}	storage temperature		-65	+150	°C
P_{tot}	total power dissipation	$T_{amb} = -40\text{ °C}$ to $+125\text{ °C}$ ^[2]	-	500	mW

- [1] The input and output voltage ratings may be exceeded if the input and output current ratings are observed.

- [2] P_{tot} derates linearly with 8 mW/K above 70 °C.

8 Recommended operating conditions

Table 5. Recommended operating conditions

Voltages are referenced to GND (ground = 0 V).

Symbol	Parameter	Conditions	Min	Typ	Max	Unit
V_{CC}	supply voltage	[1]	1.0	3.3	5.5	V
V_I	input voltage		0	-	V_{CC}	V
V_O	output voltage		0	-	V_{CC}	V
T_{amb}	ambient temperature		-40	+25	+125	°C
$\Delta t/\Delta V$	input transition rise and fall rate	$V_{CC} = 1.0\text{ V to }2.0\text{ V}$	-	-	500	ns/V
		$V_{CC} = 2.0\text{ V to }2.7\text{ V}$	-	-	200	ns/V
		$V_{CC} = 2.7\text{ V to }3.6\text{ V}$	-	-	100	ns/V
		$V_{CC} = 3.6\text{ V to }5.5\text{ V}$	-	-	50	ns/V

[1] The static characteristics are guaranteed from $V_{CC} = 1.2\text{ V}$ to $V_{CC} = 5.5\text{ V}$, but LV devices are guaranteed to function down to $V_{CC} = 1.0\text{ V}$ (with input levels GND or V_{CC}).

9 Static characteristics

Table 6. Static characteristics

Voltages are referenced to GND (ground = 0 V).

Symbol	Parameter	Conditions	-40 °C to +85 °C			-40 °C to +125 °C		Unit
			Min	Typ [1]	Max	Min	Max	
V_{IH}	HIGH-level input voltage	$V_{CC} = 1.2\text{ V}$	0.9	-	-	0.9	-	V
		$V_{CC} = 2.0\text{ V}$	1.4	-	-	1.4	-	V
		$V_{CC} = 2.7\text{ V to }3.6\text{ V}$	2.0	-	-	2.0	-	V
		$V_{CC} = 4.5\text{ V to }5.5\text{ V}$	$0.7V_{CC}$	-	-	$0.7V_{CC}$	-	V
V_{IL}	LOW-level input voltage	$V_{CC} = 1.2\text{ V}$	-	-	0.3	-	0.3	V
		$V_{CC} = 2.0\text{ V}$	-	-	0.6	-	0.6	V
		$V_{CC} = 2.7\text{ V to }3.6\text{ V}$	-	-	0.8	-	0.8	V
		$V_{CC} = 4.5\text{ V to }5.5\text{ V}$	-	-	$0.3V_{CC}$	-	$0.3V_{CC}$	V
V_{OL}	LOW-level output voltage	$V_I = V_{IH}$ or V_{IL}						
		$I_O = 100\ \mu\text{A}; V_{CC} = 1.2\text{ V}$	-	0	-	-	-	V
		$I_O = 100\ \mu\text{A}; V_{CC} = 2.0\text{ V}$	-	0	0.2	-	0.2	V
		$I_O = 100\ \mu\text{A}; V_{CC} = 2.7\text{ V}$	-	0	0.2	-	0.2	V
		$I_O = 100\ \mu\text{A}; V_{CC} = 3.0\text{ V}$	-	0	0.2	-	0.2	V
		$I_O = 100\ \mu\text{A}; V_{CC} = 4.5\text{ V}$	-	0	0.2	-	0.2	V
		$I_O = 6\text{ mA}; V_{CC} = 3.0\text{ V}$	-	0.25	0.40	-	0.50	V
$I_O = 12\text{ mA}; V_{CC} = 4.5\text{ V}$	-	0.35	0.55	-	0.65	V		
I_I	input leakage current	$V_I = V_{CC}$ or GND; $V_{CC} = 5.5\text{ V}$	-	-	1.0	-	1.0	μA

Symbol	Parameter	Conditions	-40 °C to +85 °C			-40 °C to +125 °C		Unit
			Min	Typ ^[1]	Max	Min	Max	
I _{OZ}	OFF-state output current	per input pin; V _{CC} = 2.0 V to 3.6 V; V _I = V _{IL} ; V _O = V _{CC} or GND; other inputs at V _{CC} or GND	-	-	±5.0	-	±10	µA
		per input pin; V _{CC} = 2.0 V to 3.6 V; ^[2] V _I = V _{IL} ; V _O = 6.0 V; other inputs at V _{CC} or GND	-	-	±10.0	-	±20	µA
I _{CC}	supply current	V _I = V _{CC} or GND; I _O = 0 A; V _{CC} = 5.5 V	-	-	20.0	-	40	µA
ΔI _{CC}	additional supply current	per input; V _I = V _{CC} - 0.6 V; V _{CC} = 2.7 V to 3.6 V	-	-	500	-	850	µA
C _I	input capacitance		-	3.5	-	-	-	pF

[1] Typical values are measured at T_{amb} = 25 °C.
 [2] The maximum operating output voltage (V_{O(max)}) is 6.0 V.

10 Dynamic characteristics

Table 7. Dynamic characteristics

GND = 0 V; For test circuit see Figure 6.

Symbol	Parameter	Conditions	-40 °C to +85 °C			-40 °C to +125 °C		Unit
			Min	Typ ^[1]	Max	Min	Max	
t _{pd}	propagation delay	nA, nB to nY; see Figure 5 ^[2]						
		V _{CC} = 1.2 V	-	50	-	-	-	ns
		V _{CC} = 2.0 V	-	17	26	-	31	ns
		V _{CC} = 2.7 V	-	13	19	-	23	ns
		V _{CC} = 3.3 V; C _L = 15 pF	-	8	-	-	-	ns
		V _{CC} = 3.0 V to 3.6 V ^[3]	-	10	16	-	19	ns
		V _{CC} = 4.5 V to 5.5 V	-	-	13	-	16	ns
C _{PD}	power dissipation capacitance	C _L = 0 pF; R _L = ∞ Ω; V _I = GND to V _{CC} ^[4]	-	4	-	-	-	pF

[1] All typical values are measured at T_{amb} = 25 °C.
 [2] t_{pd} is the same as t_{PLZ} and t_{PZL}.
 [3] Typical values are measured at nominal supply voltage (V_{CC} = 3.3 V).
 [4] C_{PD} is used to determine the dynamic power dissipation (P_D in µW).
 $P_D = C_{PD} \times V_{CC}^2 \times f_i \times N + \Sigma(C_L \times V_{CC}^2 \times f_o)$ where:
 f_i = input frequency in MHz,
 f_o = output frequency in MHz
 C_L = output load capacitance in pF
 V_{CC} = supply voltage in V
 N = number of inputs switching
 $\Sigma(C_L \times V_{CC}^2 \times f_o)$ = sum of the outputs.

10.1 Waveforms and test circuit

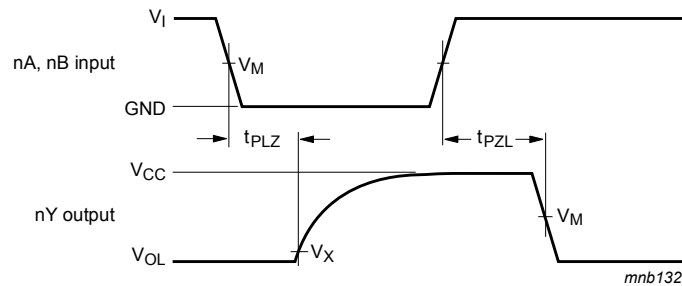

Measurement points are given in [Table 8](#)

V_{OL} is a typical voltage output level that occurs with the output load.

Figure 5. Inputs nA and nB to output nY propagation delay times

Table 8. Measurement points

Supply voltage	Input	Output	
V_{CC}	V_M	V_X	V_M
$\leq 2.7\text{ V}$	$0.5 \times V_{CC}$	$V_{OL} + 0.1\text{ V}$	$0.5 \times V_{CC}$
$2.7\text{ V to } 3.6\text{ V}$	1.5 V	$V_{OL} + 0.3\text{ V}$	1.5 V
$\geq 4.5\text{ V}$	$0.5 \times V_{CC}$	$V_{OL} + 0.1\text{ V}$	$0.5 \times V_{CC}$

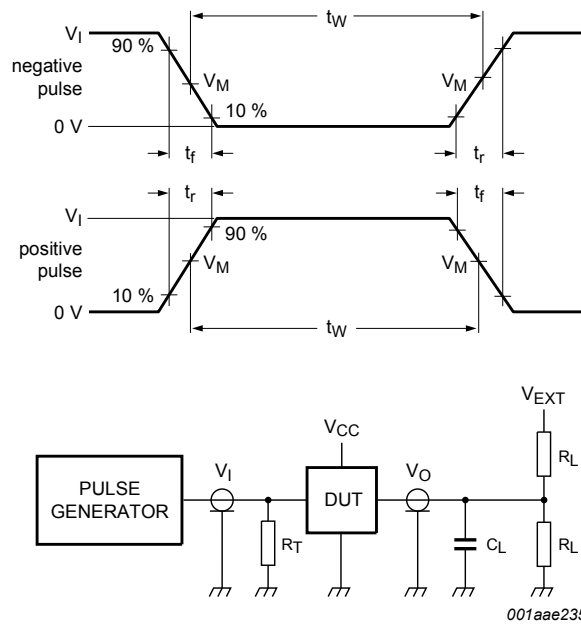

Test data is given in [Table 9](#)

Definitions for test circuit:

R_L = Load resistance.

C_L = Load capacitance including jig and probe capacitance.

R_T = Termination resistance should be equal to output impedance Z_o of the pulse generator.

V_{EXT} = External voltage for measuring switching times.

Figure 6. Test circuit for measuring switching times

Table 9. Test data

Supply voltage	Input		Load		V_{EXT}
V_{CC}	V_I	t_r, t_f	C_L	R_L	t_{PLZ}, t_{PZL}
$\leq 2.7\text{ V}$	V_{CC}	$\leq 2.5\text{ ns}$	50 pF	1 k Ω	$2 \times V_{CC}$
2.7 V to 3.6 V	2.7 V	$\leq 2.5\text{ ns}$	50 pF	1 k Ω	$2 \times V_{CC}$
$\geq 4.5\text{ V}$	V_{CC}	$\leq 2.5\text{ ns}$	50 pF	1 k Ω	$2 \times V_{CC}$

11 Package outline

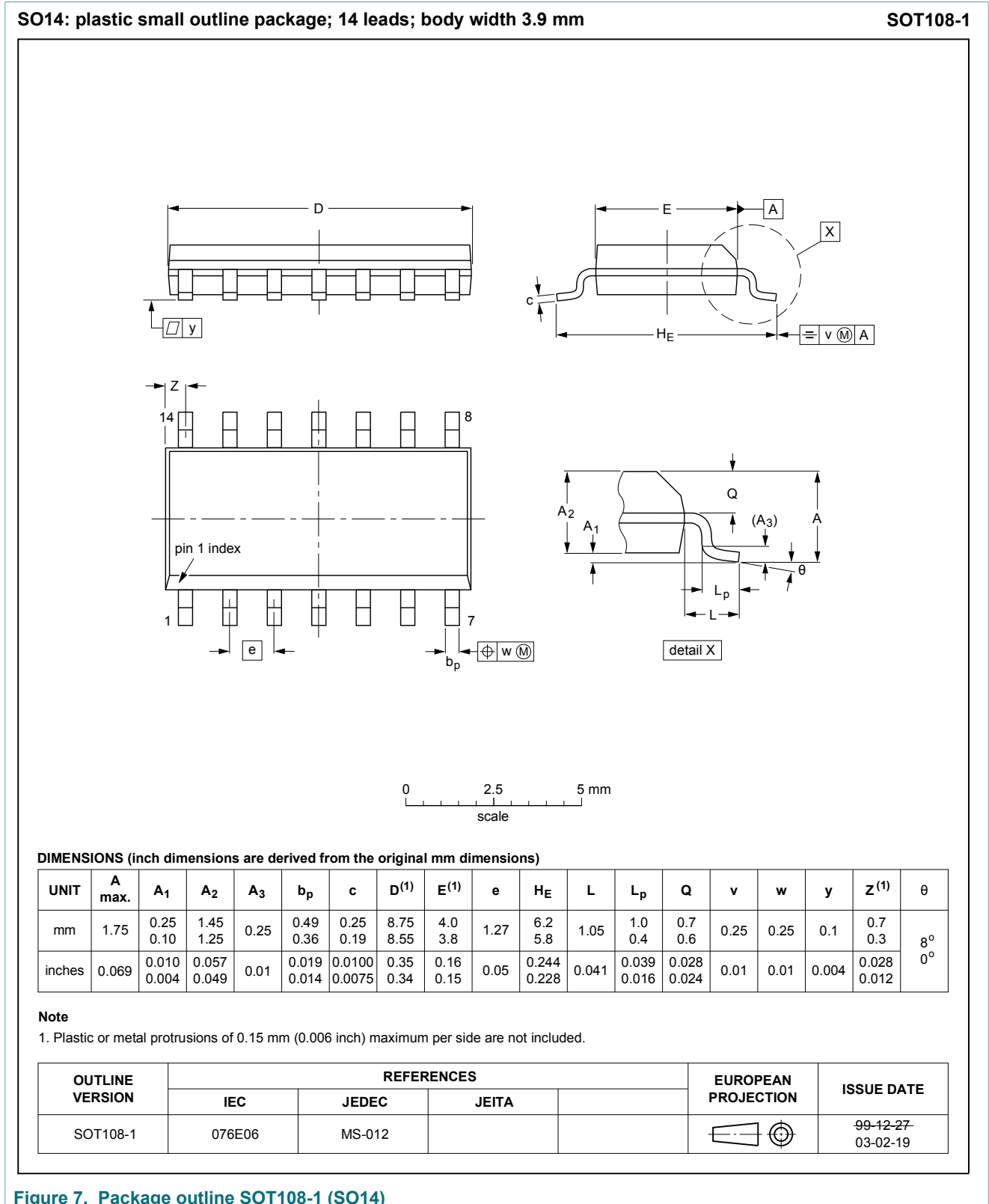

Figure 7. Package outline SOT108-1 (SO14)

12 Abbreviations

Table 10. Abbreviations

Acronym	Description
CMOS	Complementary Metal-Oxide Semiconductor
DUT	Device Under Test
TTL	Transistor-Transistor Logic

13 Revision history

Table 11. Revision history

Document ID	Release date	Data sheet status	Change notice	Supersedes
74LV03 v.4	20170831	Product data sheet	-	74LV03 v.3
Modifications:	<ul style="list-style-type: none"> The format of this data sheet has been redesigned to comply with the identity guidelines of Nexperia. Legal texts have been adapted to the new company name where appropriate. 			
74LV03 v.3	20030303	Product data sheet	ECN 853-1963 29494	74LV03 v.2
Modifications:	<ul style="list-style-type: none"> Deleted DIL, SSOP and TSSOP package ordering and package outlines (discontinued options). Corrected power dissipation formula. 			
74LV03 v.2	19980420	Product specification	ECN 853-1963 19257	74LV03 v.1
74LV03 v.1	19970328	Product specification	-	-

14 Legal information

14.1 Data sheet status

Document status ^{[1][2]}	Product status ^[3]	Definition
Objective [short] data sheet	Development	This document contains data from the objective specification for product development.
Preliminary [short] data sheet	Qualification	This document contains data from the preliminary specification.
Product [short] data sheet	Production	This document contains the product specification.

[1] Please consult the most recently issued document before initiating or completing a design.

[2] The term 'short data sheet' is explained in section "Definitions".

[3] The product status of device(s) described in this document may have changed since this document was published and may differ in case of multiple devices. The latest product status information is available on the Internet at URL <http://www.nexperia.com>.

14.2 Definitions

Draft — The document is a draft version only. The content is still under internal review and subject to formal approval, which may result in modifications or additions. Nexperia does not give any representations or warranties as to the accuracy or completeness of information included herein and shall have no liability for the consequences of use of such information.

Short data sheet — A short data sheet is an extract from a full data sheet with the same product type number(s) and title. A short data sheet is intended for quick reference only and should not be relied upon to contain detailed and full information. For detailed and full information see the relevant full data sheet, which is available on request via the local Nexperia sales office. In case of any inconsistency or conflict with the short data sheet, the full data sheet shall prevail.

Product specification — The information and data provided in a Product data sheet shall define the specification of the product as agreed between Nexperia and its customer, unless Nexperia and customer have explicitly agreed otherwise in writing. In no event however, shall an agreement be valid in which the Nexperia product is deemed to offer functions and qualities beyond those described in the Product data sheet.

14.3 Disclaimers

Limited warranty and liability — Information in this document is believed to be accurate and reliable. However, Nexperia does not give any representations or warranties, expressed or implied, as to the accuracy or completeness of such information and shall have no liability for the consequences of use of such information. Nexperia takes no responsibility for the content in this document if provided by an information source outside of Nexperia. In no event shall Nexperia be liable for any indirect, incidental, punitive, special or consequential damages (including - without limitation - lost profits, lost savings, business interruption, costs related to the removal or replacement of any products or rework charges) whether or not such damages are based on tort (including negligence), warranty, breach of contract or any other legal theory. Notwithstanding any damages that customer might incur for any reason whatsoever, Nexperia's aggregate and cumulative liability towards customer for the products described herein shall be limited in accordance with the Terms and conditions of commercial sale of Nexperia.

Right to make changes — Nexperia reserves the right to make changes to information published in this document, including without limitation specifications and product descriptions, at any time and without notice. This document supersedes and replaces all information supplied prior to the publication hereof.

Suitability for use — Nexperia products are not designed, authorized or warranted to be suitable for use in life support, life-critical or safety-critical

systems or equipment, nor in applications where failure or malfunction of an Nexperia product can reasonably be expected to result in personal injury, death or severe property or environmental damage. Nexperia and its suppliers accept no liability for inclusion and/or use of Nexperia products in such equipment or applications and therefore such inclusion and/or use is at the customer's own risk.

Applications — Applications that are described herein for any of these products are for illustrative purposes only. Nexperia makes no representation or warranty that such applications will be suitable for the specified use without further testing or modification. Customers are responsible for the design and operation of their applications and products using Nexperia products, and Nexperia accepts no liability for any assistance with applications or customer product design. It is customer's sole responsibility to determine whether the Nexperia product is suitable and fit for the customer's applications and products planned, as well as for the planned application and use of customer's third party customer(s). Customers should provide appropriate design and operating safeguards to minimize the risks associated with their applications and products. Nexperia does not accept any liability related to any default, damage, costs or problem which is based on any weakness or default in the customer's applications or products, or the application or use by customer's third party customer(s). Customer is responsible for doing all necessary testing for the customer's applications and products using Nexperia products in order to avoid a default of the applications and the products or of the application or use by customer's third party customer(s). Nexperia does not accept any liability in this respect.

Limiting values — Stress above one or more limiting values (as defined in the Absolute Maximum Ratings System of IEC 60134) will cause permanent damage to the device. Limiting values are stress ratings only and (proper) operation of the device at these or any other conditions above those given in the Recommended operating conditions section (if present) or the Characteristics sections of this document is not warranted. Constant or repeated exposure to limiting values will permanently and irreversibly affect the quality and reliability of the device.

Terms and conditions of commercial sale — Nexperia products are sold subject to the general terms and conditions of commercial sale, as published at <http://www.nexperia.com/profile/terms>, unless otherwise agreed in a valid written individual agreement. In case an individual agreement is concluded only the terms and conditions of the respective agreement shall apply. Nexperia hereby expressly objects to applying the customer's general terms and conditions with regard to the purchase of Nexperia products by customer.

No offer to sell or license — Nothing in this document may be interpreted or construed as an offer to sell products that is open for acceptance or the grant, conveyance or implication of any license under any copyrights, patents or other industrial or intellectual property rights.

Export control — This document as well as the item(s) described herein may be subject to export control regulations. Export might require a prior authorization from competent authorities.

Non-automotive qualified products — Unless this data sheet expressly states that this specific Nexperia product is automotive qualified, the product is not suitable for automotive use. It is neither qualified nor tested in accordance with automotive testing or application requirements. Nexperia accepts no liability for inclusion and/or use of non-automotive qualified products in automotive equipment or applications. In the event that customer uses the product for design-in and use in automotive applications to automotive specifications and standards, customer (a) shall use the product without Nexperia's warranty of the product for such automotive applications, use and specifications, and (b) whenever customer uses the product for automotive applications beyond Nexperia's specifications such use shall be solely at customer's own risk, and (c) customer fully indemnifies Nexperia for any liability, damages or failed product claims resulting from customer

design and use of the product for automotive applications beyond Nexperia's standard warranty and Nexperia's product specifications.

Translations — A non-English (translated) version of a document is for reference only. The English version shall prevail in case of any discrepancy between the translated and English versions.

14.4 Trademarks

Notice: All referenced brands, product names, service names and trademarks are the property of their respective owners.

Contents

1	General description	1
2	Features and benefits	1
3	Ordering information	1
4	Functional diagram	2
5	Pinning information	2
5.1	Pinning	2
5.2	Pin description	2
6	Functional description	3
7	Limiting values	3
8	Recommended operating conditions	4
9	Static characteristics	4
10	Dynamic characteristics	5
10.1	Waveforms and test circuit	6
11	Package outline	8
12	Abbreviations	9
13	Revision history	9
14	Legal information	10

Please be aware that important notices concerning this document and the product(s) described herein, have been included in section 'Legal information'.

© Nexperia B.V. 2017.

All rights reserved.

For more information, please visit: <http://www.nexperia.com>

For sales office addresses, please send an email to: salesaddresses@nexperia.com

Date of release: 31 August 2017

Document identifier: 74LV03

X-ON Electronics

Largest Supplier of Electrical and Electronic Components

Click to view similar products for [Logic Gates](#) category:

Click to view products by [NXP](#) manufacturer:

Other Similar products are found below :

[5962-8769901BCA](#) [74HC85N](#) [NL17SG08P5T5G](#) [NL17SG32DFT2G](#) [NLU1G32AMUTCG](#) [NLV7SZ58DFT2G](#) [NLVHC1G08DFT1G](#)
[NLVVHC1G14DTT1G](#) [NLX2G08DMUTCG](#) [NLX2G08MUTCG](#) [MC74HCT20ADR2G](#) [091992B](#) [091993X](#) [093560G](#) [634701C](#) [634921A](#)
[NL17SG32P5T5G](#) [NL17SG86DFT2G](#) [NLV14001UBDR2G](#) [NLVVHC1G132DTT1G](#) [NLVVHC1G86DTT1G](#) [NLX1G11AMUTCG](#)
[NLX1G97MUTCG](#) [746427X](#) [74AUP1G17FW5-7](#) [74LS38](#) [74LVC1G08Z-7](#) [74LVC32ADTR2G](#) [74LVC1G125FW4-7](#) [74LVC08ADTR2G](#)
[MC74HCT20ADTR2G](#) [NLV14093BDTR2G](#) [NLV17SZ00DFT2G](#) [NLV17SZ02DFT2G](#) [NLV17SZ126DFT2G](#) [NLV27WZ17DFT2G](#)
[NLV74HC02ADR2G](#) [NLV74HC08ADR2G](#) [NLVVHC1GT32DFT1G](#) [74HC32S14-13](#) [74LS133](#) [74LVC1G32Z-7](#) [M38510/30402BDA](#)
[74LVC1G86Z-7](#) [74LVC2G08RA3-7](#) [M38510/06202BFA](#) [NLV74HC08ADTR2G](#) [NLV74HC14ADR2G](#) [NLV74HC20ADR2G](#)
[NLV74VHC1G08DTT1G](#)