

CAGE CLAMP®

The universal connection for solid, stranded and fine-stranded conductors

Handling:
Open clamping unit,
insert the conductor,
release clamp - done!

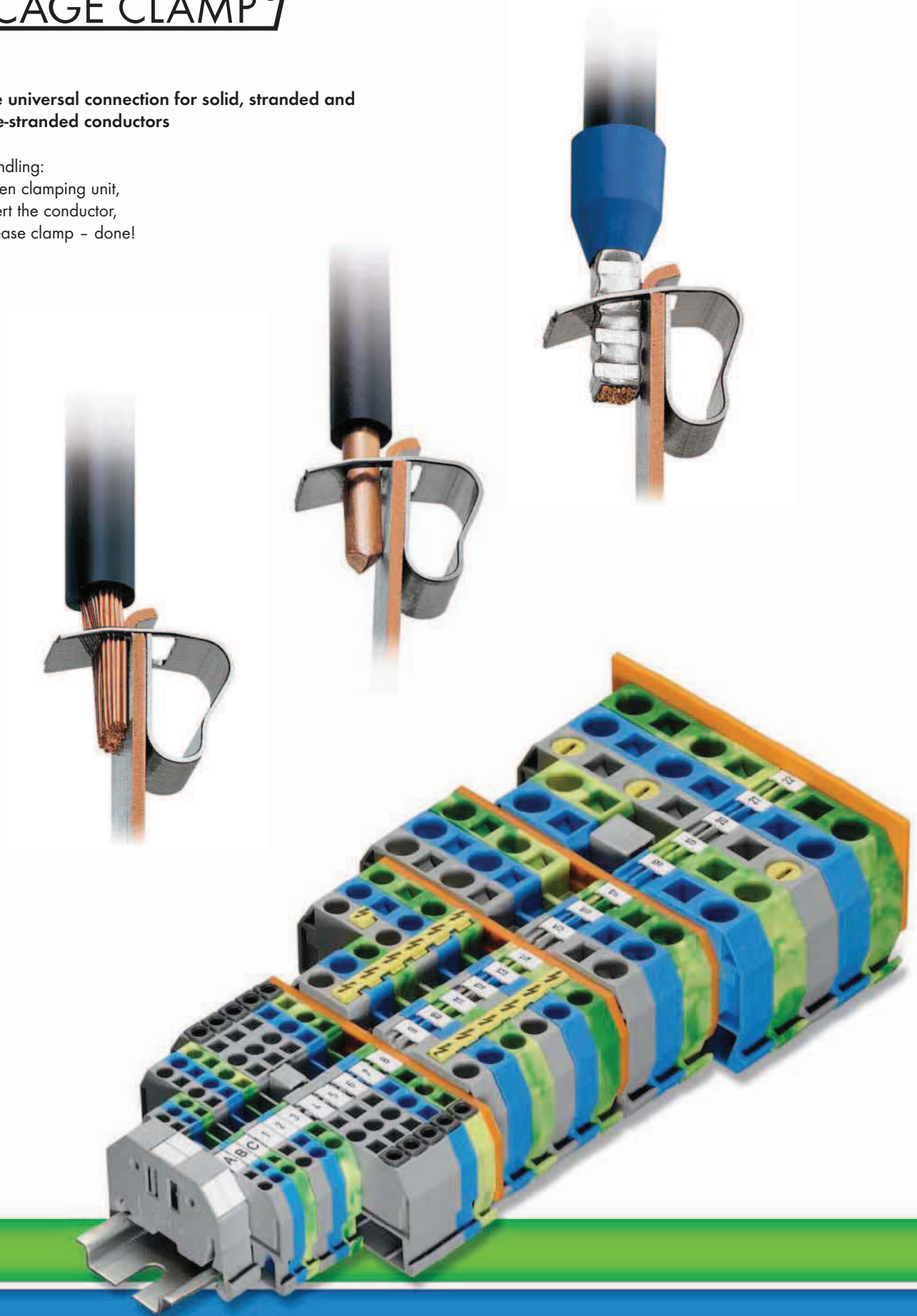

3



Through, Ground Conductor and Ex Terminal Blocks
 0.08 mm² to 35 mm² (AWG 28 - 2)
Distribution Terminal Blocks
 10 mm² / 35 mm² (AWG 8 / AWG 2)

279 - 285 and 880 Series
 284 Series

162 – 176
 177



Multilevel Rail-Mounted Terminal Blocks
Double-Deck Terminal Blocks
 1.5/2.5/4 mm² (AWG 16/12)
Triple-Deck Terminal Blocks 2.5 mm²/AWG 12
Quadruple-Deck Terminal Blocks 4 mm²/AWG 12

279/280/281 Series
 280 Series
 281 Series

180 – 188
 190
 192



Disconnect Terminal Blocks for Test and Measurement
 - with knife disconnect
 - with disconnect tab
 - for transformer circuits
Ground Conductor Disconnect Terminal Blocks

280 Series
 280/281 Series
 282 Series
 282 Series

204 – 205
 206 – 209
 214 – 219
 220



Fuse Terminal Blocks
 - with pivoting fuse holder
 - for mini-automotive blade-style fuses
Fuse Plugs for Carrier Terminal Blocks
Technical Information on Fuse Terminal Blocks and Fuse Plugs

281 Series
 282 Series
 280/281 Series

226 – 229
 222
 230 – 233
 234 – 235



Sensor and Actuator Terminal Blocks
Diode and LED Terminal Blocks
Double-Deck Diode and LED Terminal Blocks
Pluggable Modules - Diodes, LED and Neon Indicators

280 Series
 279/280/281 Series
 280/281 Series
 280 Series

238 – 253
 254 – 259
 260 – 263
 264 – 267

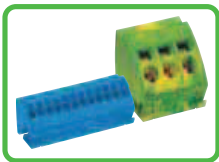

Accessories for Rail-Mounted Terminal Blocks
 - Busbar Terminal Blocks

427



- Banana Plugs
 - Insulation Stops
 - Comb-Style Jumper Bars

198
 199
 200



- Push-In Type Wire Jumpers
 - Staggered Jumpers
 - Test Plug Modules
 - Step-Down Jumpers for Through Terminal Blocks

201
 201
 194 – 197
 178 – 179

Rail-Mounted Terminal Blocks 279 to 285 Series and 880 Series

Assembly



By snapping a ground conductor terminal block onto the carrier rail, a direct electrical connection is automatically made to the rail.

Assembly

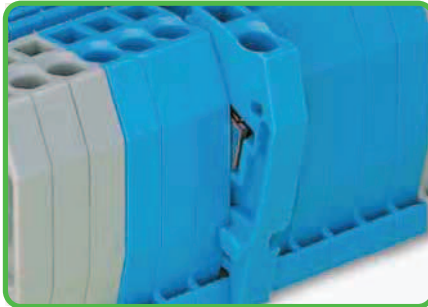

Quick assembly keys prevent reverse mounting.

Removal

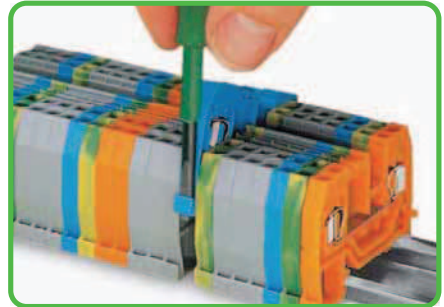

Removing a terminal block from the assembly.

Commoning



Commoning ground conductor terminal blocks with through terminal blocks is possible in one direction only (via rear side of terminal block) using adjacent jumpers. In addition to the required marking of these blocks, use yellow-green adjacent jumpers.

Commoning with step-down jumpers



Commoning terminal blocks of different sizes - step down.
For application notes, see page 178.

Commoning

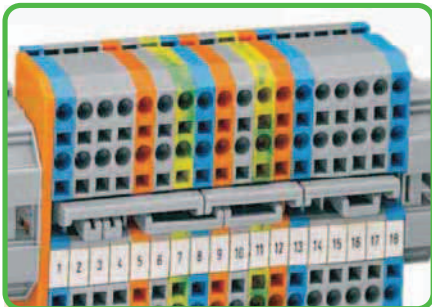

Staggered jumpers for sophisticated circuit requirements. Push jumpers down firmly until fully inserted. For additional notes, see page 201.



CAGE CLAMP® clamps the following copper conductors:^{*}
solid

Testing - 880 Series

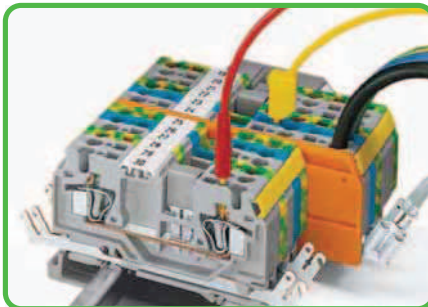

880 Series terminal blocks have an additional test slot for 2 mm Ø or 2.3 mm Ø test plugs.



stranded

Protective warning marker

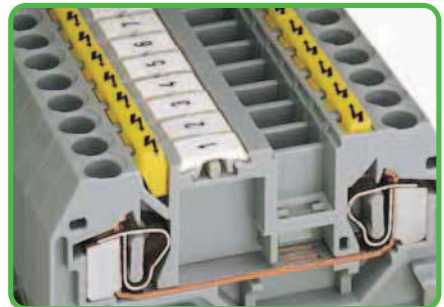

Protective warning markers inserted into the operating slots.



fine-stranded,
also with tinned
single strands

According to EN 60947-7-2 (VDE 0611, part 3), steel carrier rails shall not be used for PEN applications

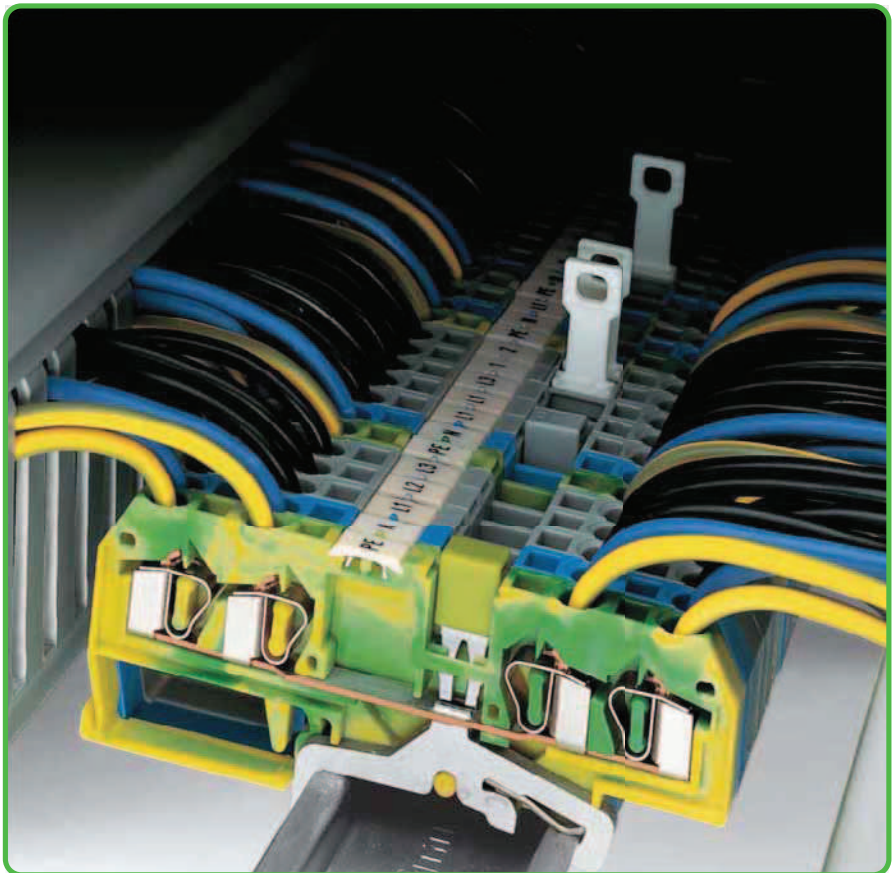

* For aluminum conductors, see notes in Section 14.

- Description and Handling -

CAGE CLAMP® connection

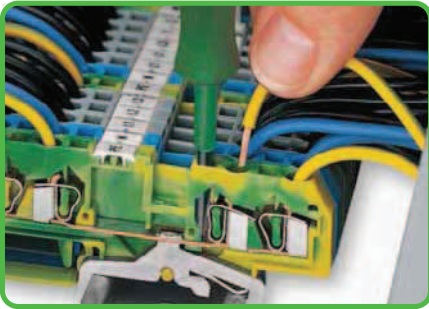

Conductor termination

CAGE CLAMP® connection

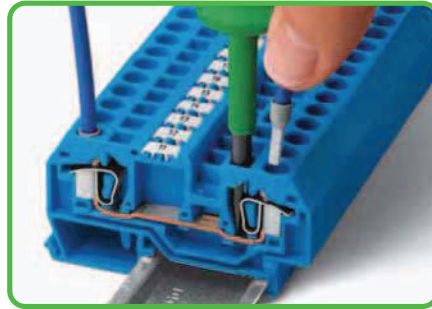

Conductor termination

❶ When using ferruled conductors, it is necessary to use a terminal block one size larger than the nominal cross section of the wire.

Testing

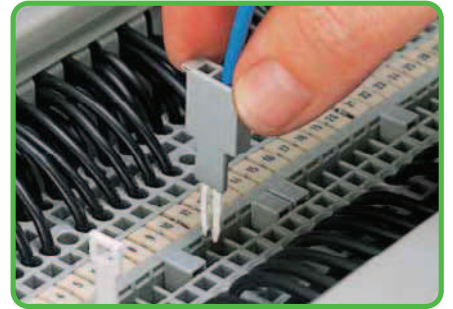

Testing with test plug.
Test plug fitted with CAGE CLAMP®.

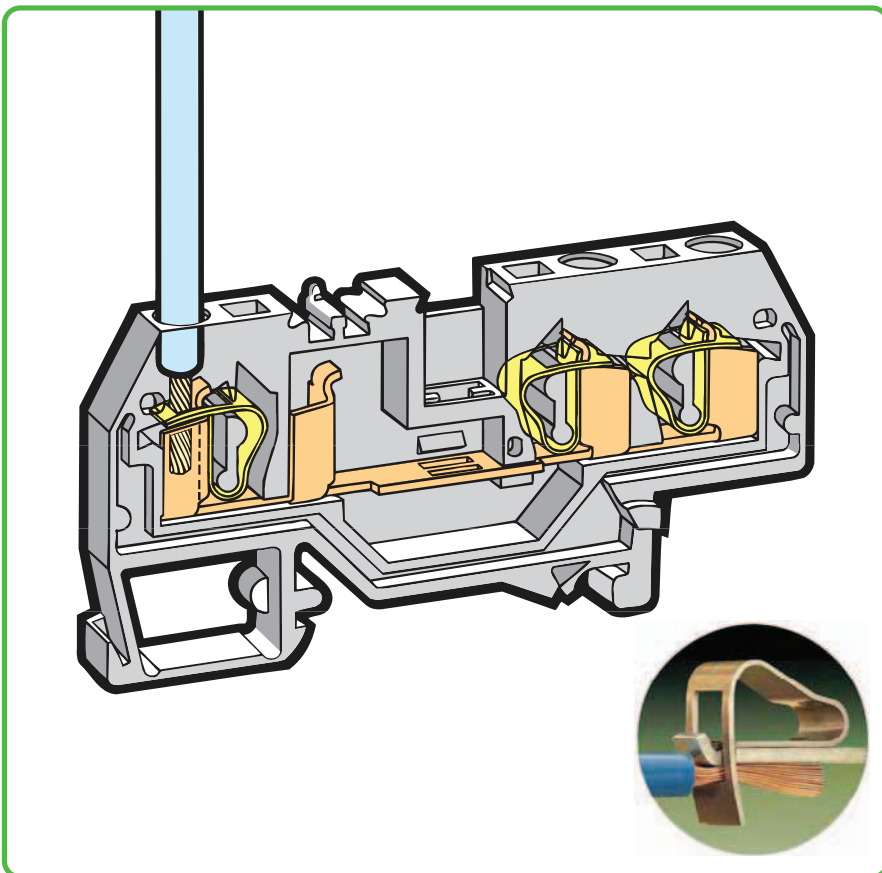

Testing

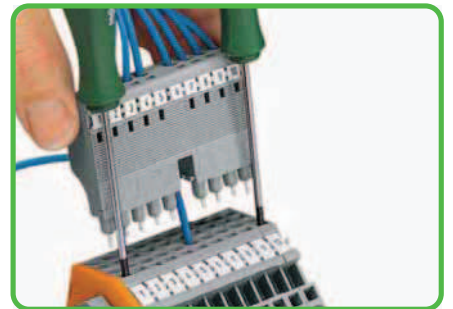

L-type test plug modules fitted with CAGE CLAMP®.
For application notes, see page 194.

Testing



B-type test plug modules fitted with CAGE CLAMP®.
For application notes, see page 195.

Marking



Marking with WMB Multi marking system.
For additional systems, see Section 13.

Insulation stop



Insertion of insulation stop.
For application notes, see page 199.

Testing

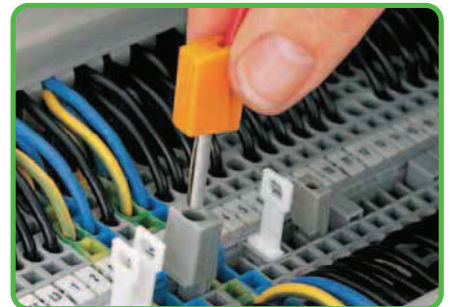

Testing with test plug.
Using 209-170 test plug adapter.



fine-stranded,
tip-bonded



fine-stranded,
with ferrule ❶
(gastight crimped)



fine-stranded,
with pin terminal
(gastight crimped)

Through/Ground Conductor/Shield and Ex Terminal Blocks 1.5 mm² 279 Series

<p>0.08 - 1.5 mm² 800 V/8 kV/3 ① I_N 18 A</p> <p>Terminal block width 4 mm / 0.157 in 8 - 9 mm / 0.33 in ②</p>	<p>AWG 28 - 16 600 V, 10 A ③ 600 V, 10 A ④</p>	<p>0.08 - 1.5 mm² 800 V/8 kV/3 ① I_N 18 A</p> <p>Terminal block width 4 mm / 0.157 in 8 - 9 mm / 0.33 in ②</p>	<p>AWG 28 - 16 600 V, 10 A ③ 600 V, 10 A ④</p>	<p>0.08 - 1.5 mm² 800 V/8 kV/3 ① I_N 18 A</p> <p>Terminal block width 4 mm / 0.157 in 8 - 9 mm / 0.33 in ②</p>	<p>AWG 28 - 16 600 V, 10 A ③ 600 V, 10 A ④</p>
---	--	---	--	---	--

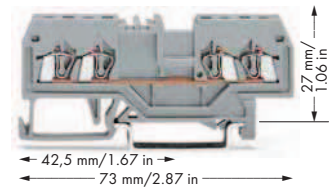
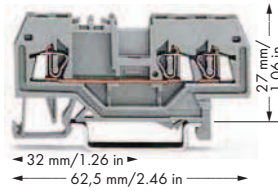
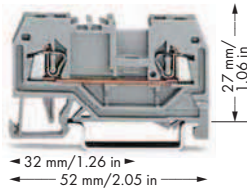

Item No.	Pack. Unit	Item No.	Pack. Unit	Item No.	Pack. Unit
2-conductor through terminal block		3-conductor through terminal block		4-conductor through terminal block	
gray 279-901	100	gray 279-681	100	gray 279-831	100
blue 279-904 ③	100	blue 279-684 ③	100	blue 279-834 ③	100
orange 279-902	100	orange 279-682	100	orange 279-832	100
red 279-903	100	red 279-683	100	red 279-833	100
black 279-905	100	black 279-685	100	black 279-835	100
yellow 279-906	100	yellow 279-686	100	yellow 279-836	100
light gray ④ 279-992 ④	100	light gray ④ 279-993 ④	100	light gray ④ 279-994 ④	100
2-conductor ground terminal block		3-conductor ground terminal block		4-conductor ground terminal block	
green-yellow 279-907	100	green-yellow 279-687	100	green-yellow 279-837	100
green-yellow ④ 279-907/999-950 ④	100	green-yellow ④ 279-687/999-950 ④	100	green-yellow ④ 279-837/999-950 ④	100
Other terminal blocks with the same profile:		Other terminal blocks with the same profile:		Other terminal blocks with the same profile:	
Diode 279-915/281-410	Page 254	Diode 279-673/281-410	Page 254	Diode 279-815/281-410	Page 254
		LED 279-674/281-434	Page 254	LED 279-809/281-434	Page 254
				Double-potential 279-826	Page 163
Item-Specific Accessories		Item-Specific Accessories		Item-Specific Accessories	
End and intermediate plate, 2 mm thick		End and intermediate plate, 2 mm thick		End and intermediate plate, 2 mm thick	
orange 279-328	100 (4x25)	orange 279-339	100 (4x25)	orange 279-346	100 (4x25)
gray 279-325	100 (4x25)	gray 279-308	100 (4x25)	gray 279-344	100 (4x25)
light gray 279-330	100 (4x25)	light gray 279-341	100 (4x25)	light gray 279-348	100 (4x25)
Separator, oversized, 2 mm thick		Separator, oversized, 2 mm thick		Separator, oversized, 2 mm thick	
orange 279-329	100 (4x25)	orange 279-340	100 (4x25)	orange 279-347	100 (4x25)
gray 279-326	100 (4x25)	gray 279-309	100 (4x25)	gray 279-345	100 (4x25)
light gray 279-331	100 (4x25)	light gray 279-342	100 (4x25)	light gray 279-349	100 (4x25)
Ex e/Ex i separator, orange, 3 mm thick		Ex e/Ex i separator, orange, 3 mm thick		Ex e/Ex i separator, orange, 3 mm thick	
90 mm 209-190	50 (2x25)	120 mm 209-191	50 (2x25)	120 mm 209-191	50 (2x25)
120 mm 209-191	50 (2x25)				
				Cover plate,	
				1 mm thick	
				gray 284-336	100
				orange 284-346	100

279 Series Accessories

Appropriate marking systems: WMB/WFB
(see Section 13)

<p>Insulation stop,</p> <p>5 pcs/strip, 0.08 - 0.2 mm² "s" (0.14 mm² "f-st") white 279-470 200 (8x25)</p>	<p>Adjacent jumper, insulated,</p> <p>I_N 15 A gray 279-402 200 (8x25) yellow-green 279-422 200 (8x25)</p>	<p>Push-in type wire jumper,</p> <p>insulated, I_N 9 A, wire size 0.75 mm² L = 60 mm 249-125 10 L = 110 mm 249-126 10 L = 250 mm 249-127 10</p>
<p>Insulation stop,</p> <p>5 pcs/strip, 0.25 mm² dark gray 279-471 200 (8x25)</p>	<p>Alternate jumper, insulated,</p> <p>I_N 15 A gray 279-409 100 (4x25)</p>	

For list of approvals and user guide, see pages 634 to 637.

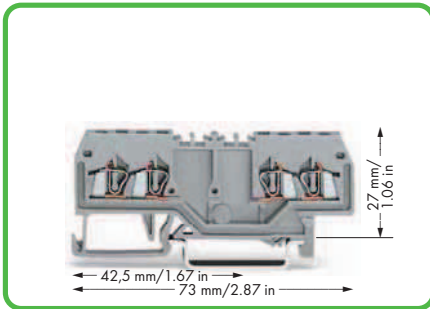

Double-potential terminal blocks
with double marker slot centered on terminal block
gray 279-826
light gray 279-995
Packing unit: 100 pcs

Notice: These double-potential terminal blocks cannot be commoned with adjacent jumpers!
For technical data and accessories, see www.wagocatalog.com

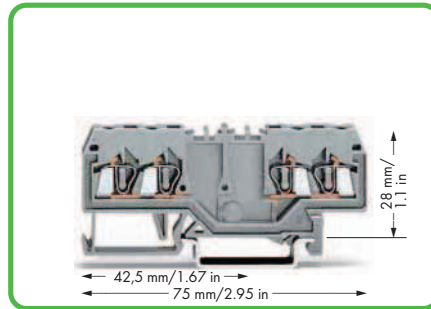

Double-potential terminal blocks
with double marker slot centered on terminal block
gray 280-826
light gray 280-995
Packing unit: 100 pcs

Notice: These double-potential terminal blocks cannot be commoned with adjacent jumpers!
For technical data and accessories, see www.wagocatalog.com

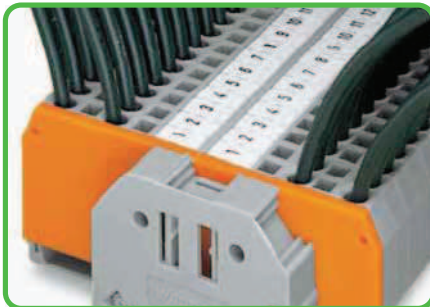

WMB markers provide marking directly on terminal block. For WMB Multi marking system, see Section 13.

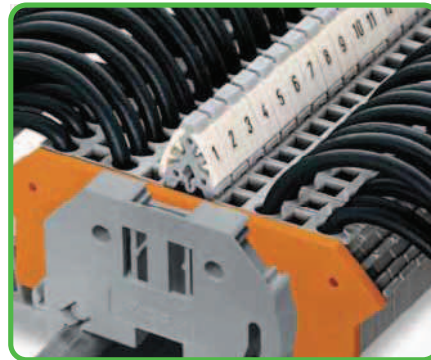

Terminal block marking with double marker carriers
Item No. 209-128
For terminal blocks with side marking, see online catalog at www.wagocatalog.com

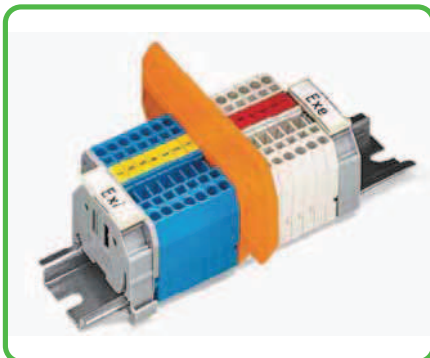

Separator for Ex e/Ex i applications
According to EN 50020, a minimum distance of 50 mm must be kept between live parts of Ex e and Ex i circuits. The use of Ex e/Ex i separators is a space-saving solution when Ex e and Ex i terminal blocks are mounted on a common carrier rail.
Suitable for 279 to 282 Series terminal blocks.
209-190 for 2-conductor terminal blocks.
209-191 for 2-, 3-, 4-conductor terminal blocks.



End and intermediate plate
In order to meet creepage and clearance requirements for Ex e applications, it is necessary to insert an end or intermediate plate between a through and a ground conductor terminal block.

- 1 800 V = rated voltage
8 kV = rated surge voltage
3 = pollution degree
(also see Section 14)
- 2 Strip length, see packaging or instructions.
- 3 Suitable for Ex i applications
- 4 Suitable for Ex e II applications
0.2 mm² - 1.5 mm²/AWG 24 - 16
550 V, 15 A
(also see Section 14)
- 5 See application notes for:
Insulation stop, page 199
Push-in type wire jumper, page 201
Step-down jumper, pages 178 - 179
Banana plug, page 198
Comb-style jumper bar, page 200
Operating tool, page 200

279 Series Accessories

Step-down jumper, insulated,			
5	I_N 15 A		
	gray	284-414	50 (2x25)
Cover plate,			
	1 mm thick		
	gray	284-334	100
	orange	284-344	100
Protective warning marker,			
	with high-voltage symbol, black, for 5 terminal blocks		
	yellow	279-415	100 (4x25)
Test plug adapter, 8.3 mm wide,			
	for terminal blocks 1.5 - 10 mm ² , for test plug 4 mm Ø		
	gray	209-170	50 (2x25)
Banana plug,			
5	for socket 4 mm Ø, color mixed		
		215-111	50
Test plug adapter, 5 mm wide,			
	for terminal blocks 1.5 - 4 mm ² , for 210-137 test plug 2.3 mm Ø		
	gray	280-404	100 (4x25)
Test plug,			
	with 500 mm cable, 2.3 mm Ø		
	yellow	210-137	50
Comb-style jumper bar, insulated,			
5	$I_N = I_N$ terminal block		
	2-way	279-482	200 (8x25)
	3-way	279-483	200 (8x25)
Comb-style jumper bar, insulated,			
	$I_N = I_N$ terminal block		
	10-way	279-490	50 (2x25)
Alternate comb-style jumper bar,			
	insulated, $I_N = I_N$ terminal block		
	2-way	279-492	200 (8x25)
Operating tool, of insulating material			
	2-way	279-432	1
	3-way	279-433	1
Operating tool, of insulating material			
	10-way	279-440	1

Through/Ground Conductor/Shield and Ex Terminal Blocks 2.5 mm² 280 Series



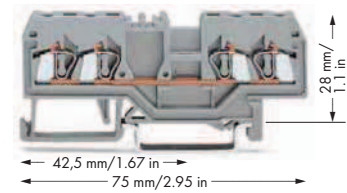
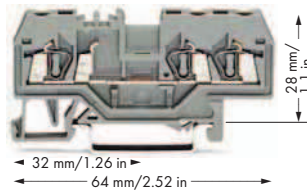
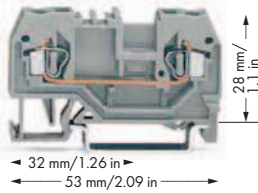

























<p>0.08 - 2.5 mm² 800 V/8 kV/3 ① I_N 24 A</p> <p>Terminal block width 5 mm / 0.197 in 8 - 9 mm / 0.33 in ②</p>	<p>AWG 28 - 12 * 600 V, 20 A ⑤ 600 V, 25 A ⑥</p>	<p>0.08 - 2.5 mm² 800 V/8 kV/3 ① I_N 24 A</p> <p>Terminal block width 5 mm / 0.197 in 8 - 9 mm / 0.33 in ②</p>	<p>AWG 28 - 12 * 600 V, 20 A ⑤ 600 V, 15 A ⑥</p>	<p>0.08 - 2.5 mm² 800 V/8 kV/3 ① I_N 20 A</p> <p>Terminal block width 5 mm / 0.197 in 8 - 9 mm / 0.33 in ②</p>	<p>AWG 28 - 12 * 600 V, 20 A ⑤ 600 V, 25 A ⑥</p>
---	--	---	--	---	--



Item No.	Pack. Unit	Item No.	Pack. Unit	Item No.	Pack. Unit
2-conductor through terminal block		3-conductor through terminal block		4-conductor through terminal block	
gray 280-901	100	gray 280-681	100	gray 280-833	100
blue 280-904 ③	100	blue 280-684 ③	100	blue 280-834 ③	100
orange 280-902	100	orange 280-650	100	orange 280-835	100
red 280-903	100	red 280-653	100	red 280-830	100
black 280-905	100	black 280-671	100	black 280-831	100
yellow 280-906	100	yellow 280-672	100	yellow 280-832	100
light gray ④	280-992 ④	100	light gray ④	280-993 ④	100
2-conductor ground terminal block		3-conductor ground terminal block		4-conductor ground terminal block	
green-yellow 280-907	100	green-yellow 280-687	100	green-yellow 280-837	100
green-yellow ④	280-907/999-950 ④	100	green-yellow ④	280-687/999-950 ④	100
Other terminal blocks with the same profile:		Other terminal blocks with the same profile:		Other terminal blocks with the same profile:	
Diode 280-915/281-410	Page 256	Diode 280-673/281-410	Page 256	Diode 280-815/281-410	Page 256
Disconnect 280-912	Page 206	Disconnect 280-683	Page 206	LED 280-809/281-434	Page 256
Carrier 280-916	Page 232	Carrier 280-610	Page 232	Disconnect 280-836	Page 206
				Disc., test & meas. 280-829	Page 206
				Carrier 280-816	Page 232
				Double-potential 280-826	Page 163
Item-Specific Accessories		Item-Specific Accessories		Item-Specific Accessories	
End and intermediate plate, 2.5 mm thick		End and intermediate plate, 2.5 mm thick		End and intermediate plate, 2.5 mm thick	
orange 280-309	100 (4x25)	orange 280-326	100 (4x25)	orange 280-315	100 (4x25)
gray 280-308	100 (4x25)	gray 280-324	100 (4x25)	gray 280-314	100 (4x25)
light gray 280-356	100 (4x25)	light gray 280-358	100 (4x25)	light gray 280-352	100 (4x25)
Separator, oversized, 2 mm thick		Separator, oversized, 2 mm thick		Separator, oversized, 2 mm thick	
orange 280-311	100 (4x25)	orange 280-346	100 (4x25)	orange 280-335	100 (4x25)
gray 280-310	100 (4x25)	gray 280-344	100 (4x25)	gray 280-334	100 (4x25)
light gray 280-357	100 (4x25)	light gray 280-359	100 (4x25)	light gray 280-353	100 (4x25)
Ex e/Ex i separator, orange, 3 mm thick		Ex e/Ex i separator, orange, 3 mm thick		Ex e/Ex i separator, orange, 3 mm thick	
90 mm 209-190	50 (2x25)	120 mm 209-191	50 (2x25)	120 mm 209-191	50 (2x25)
120 mm 209-191	50 (2x25)				
Spacer of same shape, 5 mm thick		Spacer of same shape, 5 mm thick		Spacer of same shape, 5 mm thick	
orange 280-902/056-000	100 (4x25)	orange 280-650/056-000	100	orange 280-835/056-000	100 (4x25)
				Cover plate, 1 mm thick	
				gray 284-336	100
				orange 284-346	100

For list of approvals and user guide, see pages 634 to 637.

- * AWG 12: THHN, THWN
- ① 800 V = rated voltage
8 kV = rated surge voltage
3 = pollution degree
(also see Section 14)
- ② Strip length, see packaging or instructions.
- ③ Suitable for Ex i applications
- ④ Suitable for Ex e II applications
0.2 mm² - 2.5 mm²/AWG 24 - 12*
550 V
23 A for 2-conductor terminal blocks
22 A for 3-conductor terminal blocks
20 A for 4-conductor terminal blocks
(also see Section 14)
Using staggered jumpers reduces the maximum rated voltage to 275 V.
- ⑤ See application notes for:
Test plug modules, pages 194 - 196
Banana plug, page 198
Insulation stop, page 199
Comb-style jumper bar, page 200
Operating tool, page 200
Staggered jumper, page 201
Push-in type wire jumper, page 201
Step-down jumper, pages 178 - 179

280 Series Accessories			Appropriate marking systems: WMB/WMB Inline/WFB (see Section 13)		
Insulation stop,  5 pcs/strip, 0.08 - 0.2 mm ² "s" (0.14 mm ² "f-st") white 280-470 200 (8x25)	Alternate comb-style jumper bar,  insulated, I _N = I _N terminal block 2-way 280-492 200 (8x25)	Banana plug,  for socket 4 mm Ø, color mixed 215-111 50			
Insulation stop,  5 pcs/strip, 0.25 - 0.5 mm ² light gray 280-471 200 (8x25)	Operating tool, of insulating material  2-way 280-432 1 3-way 280-433 1	Test plug adapter, 6 mm wide,  with CAGE CLAMP®, for 0.08 - 2.5 mm ² I _N 24 A 281-407 100 (4x25)			
Insulation stop,  5 pcs/strip, 0.75 - 1 mm ² dark gray 280-472 200 (8x25)	Operating tool, of insulating material  10-way 280-440 1	WMB Inline, plain,  stretchable 5 - 5.2 mm, 1,500 WMB markers, 5 mm, on roll white 2009-115 1			
Adjacent jumper, insulated,  I _N = I _N terminal block gray 280-402 200 (8x25) yellow-green 280-422 200 (8x25)	Step-down jumper, insulated,  I _N 15 A gray 284-414 50 (2x25)	WMB Multi marking system,  10 strips with 10 markers per card, stretchable 5 - 5.2 mm plain 793-5501 5			
Alternate jumper, insulated,  I _N = I _N terminal block gray 280-409 100 (4x25)	Cover plate,  1 mm thick gray 284-334 100 orange 284-344 100	WMB Multi marking system, plain,  10 strips with 10 markers per card, stretchable 5 - 5.2 mm yellow 793-5501/000-002 red 793-5501/000-005 blue 793-5501/000-006 gray 793-5501/000-007 orange 793-5501/000-012 light green 793-5501/000-017 green 793-5501/000-023 violet 793-5501/000-024 5			
Staggered jumper,  ⑤ insulated, width 5 mm/0.197 in, I _N 24 A from 1 to 2 780-452 100 (4x25) from 1 to 3 780-453 100 (4x25) from 1 to 4 780-454 100 (4x25) from 1 to 5 780-455 50 (2x25) from 1 to 6 780-456 50 (2x25) from 1 to 7 780-457 50 (2x25) from 1 to 8 780-458 50 (2x25)	Protective warning marker,  with high-voltage symbol, black, for 5 terminal blocks yellow 280-415 100 (4x25)				
	Test plug module,  ⑤ can be snapped together, 5 mm wide gray 280-418 100 (4x25)				
	Spacer module,  can be snapped together, 5 mm wide gray 280-419 100 (4x25)	Screwless end stop,  for DIN 35 rail, 6 mm wide gray 249-116 100 (4x25)			
Push-in type wire jumper,  ⑤ insulated, I _N 9 A, wire size 0.75 mm ² L = 60 mm 249-125 10 L = 110 mm 249-126 10 L = 250 mm 249-127 10	Test plug,  with 500 mm cable, 2 mm Ø red 210-136 50	Screwless end stop,  for DIN 35 rail, 10 mm wide gray 249-117 50 (2x25)			
	Test plug,  with 500 mm cable, 2.3 mm Ø yellow 210-137 50				
Comb-style jumper bar, insulated,  ⑤ I _N = I _N terminal block 2-way 280-482 200 (8x25) 3-way 280-483 200 (8x25)	Test plug adapter, 5 mm wide,  for terminal blocks 1.5 - 4 mm ² , for 210-137 test plug 2.3 mm Ø gray 280-404 100 (4x25)				
Comb-style jumper bar, insulated,  I _N = I _N terminal block 10-way 280-490 50 (2x25)	Test plug adapter, 8.3 mm wide,  for terminal blocks 1.5 - 10 mm ² , for test plug 4 mm Ø gray 209-170 50 (2x25)				

X-ON Electronics

Largest Supplier of Electrical and Electronic Components

Click to view similar products for [DIN Rail Terminal Blocks](#) category:

Click to view products by [Wago](#) manufacturer:

Other Similar products are found below :

[1045932](#) [00110420202](#) [00110430402](#) [5724.2/L](#) [592808-3](#) [CTS25U/BL](#) [CTS2.5U-N/Y](#) [91.010](#) [91.040](#) [DP25-GY-ND](#) [15288](#) [90.070](#) [90.905](#)
[91.001](#) [91.020](#) [91.201](#) [91.340](#) [2713793](#) [2757571](#) [280-331](#) [283-317](#) [283-607](#) [2909044](#) [2909798](#) [29-2052](#) [SRT2-OD08CL-1](#)
[CDL4U\(E\)MOV](#) [2757801](#) [2794660](#) [284-317](#) [2890975](#) [2907033](#) [3048496](#) [CTS2.5U-N/O](#) [5542152](#) [5602077](#) [0709880](#) [5520682](#) [5605444](#)
[5607102](#) [EPUSC](#) [SRT2-OD16P](#) [2901288](#) [591620-2](#) [1-591651-1](#) [NRA37-1/2](#) [592814-1](#) [592814-3](#) [SRT2-ID16P](#) [NRA37-12](#)