



FIBOX^{EK}

FOUR EASY STEPS TO BUILD A DISTRIBUTION PANEL THAT WORKS

BASE

FURNISH

CLAD

ROOF



Medium to large size enclosures manufactured using impact resistant polycarbonate.

Available with one or more flange openings. The flange openings allow modular assembly of several enclosures and the addition of various size cable glands and knockout flanges. Select from a large selection of standard flanges or request flanges machined separately to customer specifications. The EK bases feature multiple mounting pods.

A large range of accessories is available.

FIBOX EK

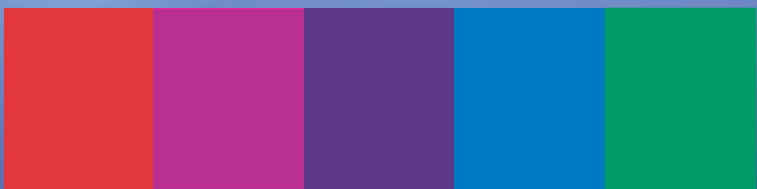

BASE



Base = **EKHA**



Base = **EKJB**



Base = **EKMB**



Base = **EKOE**



Base = **EKPE**



Base = **EKPK**



Base = **EKTH**



Base = **EKUH**



Base = **EKWH**

ENCLOSURE BASES

Impact-resistant, medium to large size polycarbonate enclosure with a high protection rating (IP 67). Pre-pressed flange panels can accept a variety of flange plates from the EK accessory range.

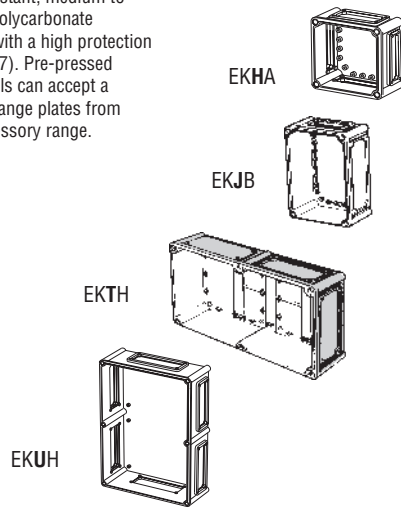

ORDER SYMBOL	SIZE mm
EKHA	190x190x100
EKHS	190x190x100
EKJB	280x190x100
EKMB	380x190x100
EKMR	380x190x100
EKOE	280x280x100
EKPE	380x280x100
EKPG	380x280x100
EKPK	380x280x150
EKPL	380x280x150
EKTH	560x280x100
EKUH	560x380x150
EKUM	560x380x150
EKUN	560x380x150
EKWH	760x560x150

THE THIRD LETTER OF THE ORDER SYMBOL INDICATES THE SIZE OF THE ENCLOSURE:
For example the letter J in the order symbol EKJB stands for the size 280x190 mm

- H = 190x190 mm
- J = 280x190 "
- M = 380x190 "
- O = 280x280 "
- P = 380x280 "
- T = 560x280 "
- U = 560x380 "
- W = 760x560 "

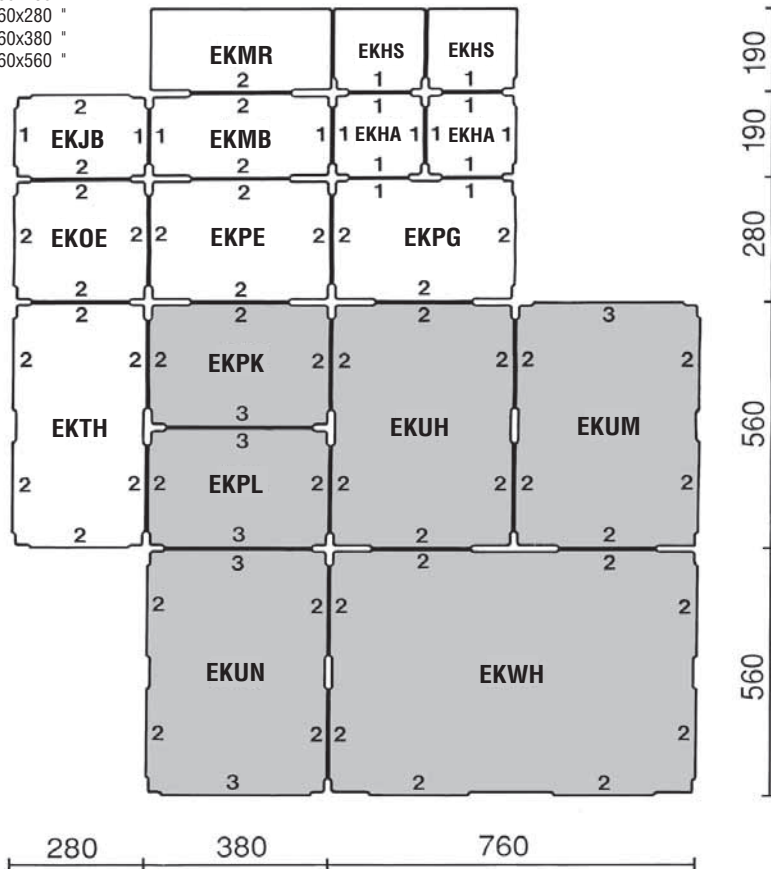

The bases marked with the grey colour have a depth of 150 mm, the others are 100 mm. The number on the bases indicates the size of the flange plate.

BASE

EXAMPLE OF THE ASSEMBLY OF ONE ENCLOSURE

THE SIZE OF THE WHOLE ENCLOSURE ACCORDING TO THE LETTER:
The enclosure sized (280x190x230) can be assembled as follows:

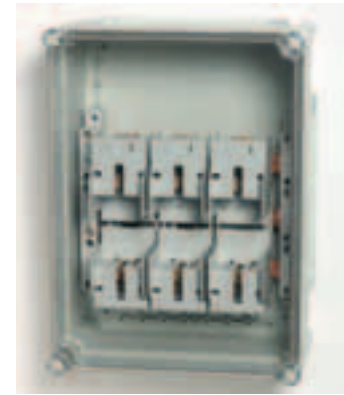
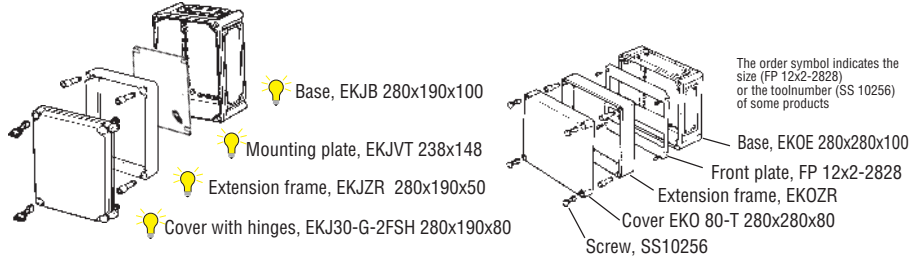

ASSEMBLING ENCLOSURES

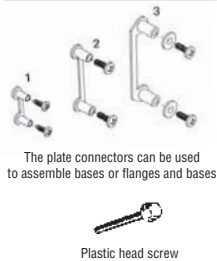

Connector set + 4 screws
Connector set + 4 screws
Connector set + 4 screws

Plastic head screw for the assembly of bases with six 1 opening
Plastic head screw for the assembly of bases with size 2 openings

Lock nuts for plastic head screws

ORDER SYMBOL	SIZE
MB 10671	1
MB 10670	2
MB 10672	3
MB 10472	M6x30
MB 10474	M8x30
M6	M6
M8	M8

EXTENSION FRAMES

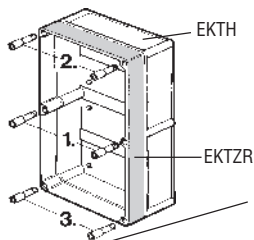

Extension frame 50 mm, between base and cover.

ORDER SYMBOL	SIZE mm
EKJZR	280x190x50
EKMZR	380x190x50
EKOZR	280x280x50
EKPZR	380x280x50
EKTZR	560x280x50
EKUZR	560x380x50

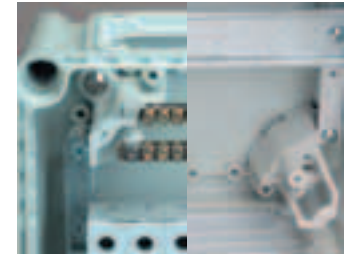

SUPPORT FLANGES



Support flange
Support flange

ORDER SYMBOL	SIZE
MB 10025	2
MB 10026	1

WALL FASTENING LUG

Separate enclosures and small distribution panels (2-4 enclosures) can be assembled straight to the wall with screws or with wall fastening lugs.

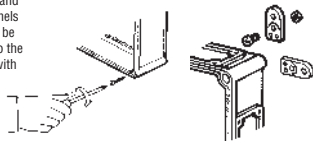

Wall fastening lug set, 4 pcs incl. screws

ORDER SYMBOL

MB 10674



FASTENING OF BIG SYSTEMS

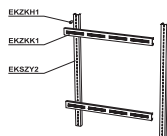

Connecting rail, standard length 2000 mm
Stud rail, standard length 2000 mm
Lock for connecting rail

ORDER SYMBOL

EKZKK1

EKSYZ2

EKZKH1



THE BASE CONNECTORS

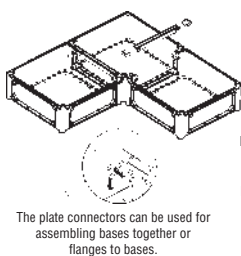

Connection bridge and gasket
Connection bridge and gasket

ORDER SYMBOL	SIZE
MB 10717	2
MB 10718	3



FURNISH

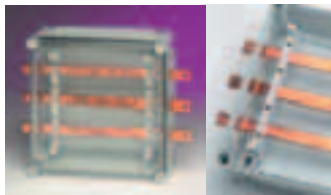

FURNISH

MOUNTING PLATES

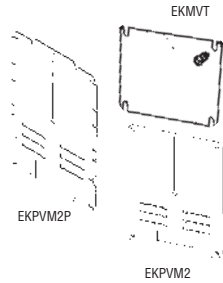

Note!
EK-mounting
plates also for
Solid-enclosure.

Mounting plate, metal
Mounting plate, metal
Mounting plate, metal
Mounting plate, metal
Mounting plate, metal
Mounting plate, metal
Mounting plate, metal



ORDER SYMBOL	SIZE mm
EKHVT	148x148
EKJVT	238x148
EKMVT	338x148
EKOVT	238x238
EKPVT	338x238
EKTVT	518x238
EKUVT	518x338

KWh-mounting plate, metal
KWh- mounting plate, plastic
Accessory screws for mounting
the KWn meter

EKPVM2	338x238
EKPVM2P	338x238
M6x16	6x16

DIN RAILS

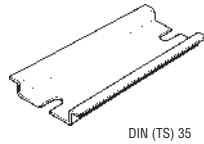

DIN-rail
DIN-rail
DIN-rail
DIN-rail
Self-cutting mounting screw

ORDER SYMBOL	SIZE mm
EKV 12	35x160
EKV 22	35x235
EKV 32	35x335
EKV 50	35x500
MSM PT 5x10	4.8x9.5

DIN RAIL FRAME

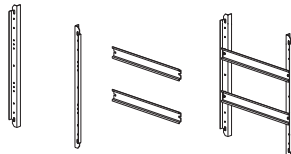

DIN frame profile
DIN frame profile
DIN frame profile
DIN frame profile

ORDER SYMBOL	SIZE mm
MS PROF 19	87
MS PROF 28	166
MS PROF 38	266
MS PROF 56	444

Screws for DIN-rail (terminal) assembly order MSM PT 5x10

FX FP FRONT PLATES FX20 SET -CORNER STUDS

Note!
Openings for
DIN-modules

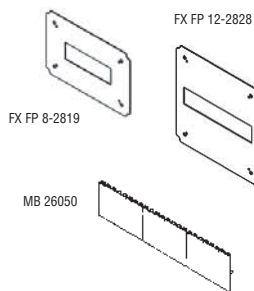

Blue 2 mm PC front plate
Blue 2 mm PC front plate
Blue 2 mm PC front plate
Blue 2 mm PC front plate

ORDER SYMBOL	SIZE mm
FX FP 8-2819	280x190
FX FP 12-2828	280x280
FX FP 2*12-2838	280x380
FX FP 3*12-2856	280x560

Cover plate (12 mod.)

MB 26050

CORNER STUD FX 2000

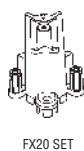

Set of corner studs FX 2000
Corner stud FX 2000 (separate)
Front plate screw FX 2000
PE/N brass bar
Screws for mounting PE/N
brass bar

ORDER SYMBOL	SIZE mm
FX20 SET	
MB 10791	
MB 10792	
MS BAR 2+18	10x6.5x187
MR 28005EU	40x18

FURNISH

MB FP FRONT PLATES FOR MB 60MM BUS-BAR HOLDES

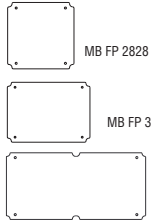

	ORDER SYMBOL	SIZE mm
Blue 2 mm PC front plate	MB FP 2828	280x280
Blue 2 mm PC front plate	MB FP 3828	380x280
Blue 2 mm PC front plate	MB FP 5628	560x280

60 MM BUS-BAR

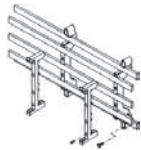

Bus-bar support set
incl. screws and support

ORDER SYMBOL
MB 60MM

For assembling to middle of the enclosure use screws KN4.8x13

RATED CURRENT	250 A	400 A
Bus-bar sizes	L1, L2, L3 20 x 5 mm	20 x 10 mm
	PE/N 15 x 5 mm	15 x 5 mm

SOLID FRAME COVERS

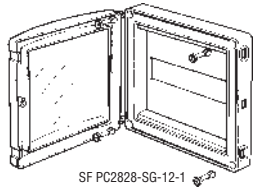

SF PC2828-SG-12-1

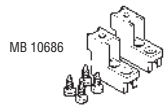

MB 10686

	ORDER SYMBOL	SIZE mm
Solid Frame covers		
With opening 1x12 mod.	SF PC2828-SG-12-1	280x280x54
With opening 2x12 mod.	SF PC2828-SG-12-2	280x280x54

DIN-rail EKV 22 35x235

Note!
SOLIDFRAME cover fits to
EKOE and SOLID 2828 bases

Extension for DIN rail/mbc MB 10686 15/34

SPACERS

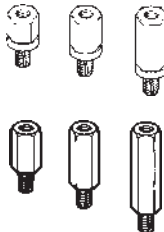

	ORDER SYMBOL	SIZE mm
M6 spacers, self-cutting for corners of the base	MR 10726	15
M6 spacers, self-cutting for corners of the base	MR 10727	20
M6 spacers, self-cutting for corners of the base	MR 10728	30
M6 spacers, self-cutting for corners of the base	MR 10729	54
M6/M6 extension for MR spacer	HR 10	10
M6/M6 extension for MR spacer	HR 15	15
M6/M6 extension for MR spacer	HR 20	20
M6/M6 extension for MR spacer	HR 30	30
M5 spacers, self-cutting for middle mounting pods	FA 12052	42
	FA 12053	14

FP FRONT PLATES FOR FB88 AND FP882 SPACERS

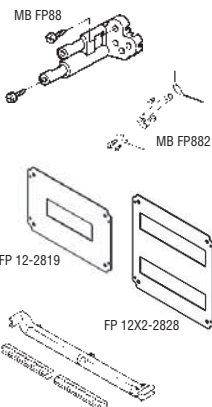

	ORDER SYMBOL	SIZE mm
Distance spacer for front plates, 1set, 2 pcs	MB FP88	88
Distance spacer for front plates, 1set, 2 pcs	MB FP882	88
FP front plate with DIN-openings	FP12-2819	280x190
FP front plate with DIN-openings	FP12-2828	280x280
FP front plate with DIN-openings	FP12x2-2828	280x280
FP front plate with DIN-openings	FP12x2-2838	280x380
FP front plate with DIN-openings	FP12x3-2838	280x380
FP front plate with DIN-openings	FP12x3-2856	280x560
N/PE-terminal bracket, incl. 2 pcs of MR 26100 terminals (16-holes)	MB 26069SET	
Terminal bus-bar clamp, 25 mm ²	MS BAR CLAMP	
Terminal bus-bar clamp, 35 mm ²	MR 26145	



GLAD

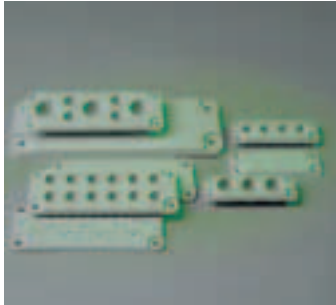

PLATES

		ORDER SYMBOL	SIZE
	MB 10215	MB 10215	1
	Cover plate	MB 10546	2
	Cover plate	MB 10324	3
	MB 10537	MB 10151	1
	Cable gland plates, threads 4xPG 13,5	MB 10149	1
	Cable gland plates, threads 3xPG 21	MB 10214	1
	Cable gland plates, threads 1xPG 29	MB 10537	1
	Cable gland plates, threads 4xM20*1.5	MB 10892	1
	Cable gland plates, threads 12xPG 16	MB 10014	2
	Cable gland plates, threads 12xPG 13,5	MB 10015	2
	Cable gland plates, threads 6xPG 16+4xPG21	MB 10016	2
	Cable gland plates, threads 4xPG 16+3xPG29	MB 10017	2
	Cable gland plates, threads 4xPG 16+2xPG36	MB 10019	2
	Cable gland plates, threads 12xM20*1.5	MB 10891	2
	Knock-out plates 9xPG 11+5xPG9/16	MB 10593	2
	Knock-out plates 4xPG 21/29	MB 10594	2
	Knock-out plates 13xPG16	MB 10595	2
	Knock-out plates 4xPG 11/21+7xPG16	MB 10596	2
	Knock-out plates 4x 1/2" + 2x 3/4" + 1x 3/4" / 1"	MB 10856	2
	Knock-out plates 4xM12+4xM12 / M20 + 4xM16/M25	MB 10857	2
	Knock-out plates 8xM20+5xM25 / M16	MB 10889	2
	Knock-out plates 2xM32 / M20 + 2xM40/M25	MB 10890	2
	Flange gasket 1	MK 10437	1
	Flange gasket 2	MK 10438	2
	Flange gasket 3	MK 10439	3
	Flange gasket 1, for smooth side	MK 10440	1
	Flange gasket 2, for smooth side	MK 10441	2
	Connector set + 4 screws	MB 10671	1
	Connector set + 4 screws	MB 10670	2
	Connector set + 4 screws	MB 10672	3
	Plastic screw, lock nut, flange gasket	EKZA 7	1
	Plastic screw, lock nut, flange gasket	EKZA 8	2
	Plastic screw, lock nut, flange gasket	EKZA 9	3
	Plastic head screw for size 1 flange	MB 10345	M6x25
	Plastic head screw for size 2 flange	MB 10346	M8x25
	Plastic head screw for size 3	MB 10347	M10x30
	Lock nut for plastic head screws	M6	M6
	Lock nut for plastic head screws	M8	M8
	Lock nut for plastic head screws	M10	M10

The plate connectors can be used to assemble flanges and bases

Plastic head screw

MEMBRANE FLANGE PLATE

		ORDER SYMBOL	SIZE
	Membrane flange plate, IP 65		
	1x7-10+2x10-14+2x15-30	FMB 5	1
	2x24-54+1x30-60	FMC 3	2
	4x5-7+4x8-12+12x10-14+4x14-20+1x20-26	FMC 25	2
	2x5-7+6x6-10+8x7-12+16x10-14+2x12-18+1x17-32	FMC 35	2
	FMB 5 assembly: order MB 10671 connector set		
	FMC 3, -25, -35 : "fast" connectors incl. delivery		

PLATE EXTENSION

		ORDER SYMBOL	SIZE
	MB 10391	MB 10391	2
	Height of the extension 25 mm		
	Mounting with four MB 10392		
	M8x50 plastic head screw	MB 10392	

WATER PLUG VENTILATOR

		ORDER SYMBOL	SIZE
	MB 12189	MB 12189	
	Pressure stabilizer, M12x1,5	MB 10894	
	Ventilation device	MB 10631	
	Ventilation device, gasgeted, incl. screws	MB 10564 II	
	Grille/filter holder for MB 10564 II. Optional	MB 10858 II	
	Holder for 40 x 40 mm fan, incl. screws	MB 10859 II	

GLAD

CABLE ENTRY BOXES

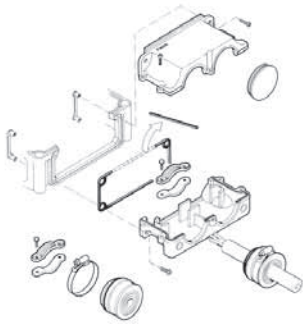

Including: base, cover, cover screws, 1 blind plug, 1 pull-off, hose clamp with screws, membrane cable gland, and plate connector set.

ORDER SYMBOL

MB 2260

Accessory set
Including: membrane cable gland, pull-off, and hose clamp with screws.

MB 2260A



Use plastic head screws for assembly

CABLE ENTRY

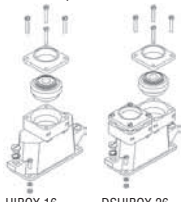

HIBOX 16

DSHIBOX 26



EPA 2160



EPA 2260



MK 10426



MK 10428

Cable entry, 1 cable (incl. rubber gasket)
Cable entry, 2 cables (incl. rubber gasket)

ORDER SYMBOL FLANGE SIZE

HIBOX 16 2

DSHIBOX 26 2

Cable entry (1 cable)
Cable entry (2 cables)
Cable entry (1 cable)
Cable entry (2 cables)

EPA 1130 1

EPA 1230 1

EPA 2160 2

EPA 2260 2

Rubber gasket for cable entry EPA 1130-1230
Rubber gasket for cable entry EPA 2160-2260

MK 10426

MK 10428

SIZE MM
10-31
28-60

CABLE GLANDS

METRIC!



Metric Cable gland, PA
PA=cable glands in polyamide
Grey RAL 7035
Temperature range
-40° (-+100°)
New metric dimensions EN 60423!

ORDER SYMBOL	FOR CABLE mm	METRIC SIZE	CLEARANCE HOLE Ø mm
GPA M12	3-6	M12x1,5	12,5
GPA M16	5-10	M16x1,5	16,5
GPA M20	8-13	M20x1,5	20,5
GPA M25	11-17	M25x1,5	25,5
GPA M32	15-21	M32x1,5	32,5
GPA M40	19-28	M40x1,5	40,5
GPA M50	27-35	M50x1,5	50,5
GPA M63	32-42	M63x1,5	60,5



Metric Hexagonal lock nut PA
B-lock nuts for cable gland, polyamide

ORDER SYMBOL	METRIC SIZE
GPA M12-B	M12x1,5
GPA M16-B	M16x1,5
GPA M20-B	M20x1,5
GPA M25-B	M25x1,5
GPA M32-B	M32x1,5
GPA M40-B	M40x1,5
GPA M50-B	M50x1,5
GPA M63-B	M63x1,5



Membrane cable glands
EPDM
IP 65 (EN 60529)
Wall thickness (C) 1,5 - 5 mm

ORDER SYMBOL	FOR CABLE mm	METRIC SIZE	CLEARANCE HOLE, PG
FEM 3-5	3-5	M12	12,5
FEM 5-7	5-7	M16	16,5
FEM 7-10	7-10	M20	20,5
FEM 10-14/23	10-14	M23/PG16	23,5
FEM 10-14/25	10-14	M25	25,5
FEM 14-20	14-20	M32	32,5
FEM 20-26	20-26	M40	40,5
FEM 26-35	26-35	M50	50,5
FEM 30-45	30-45	M60	60,5



Multifem

ORDER SYMBOL	FOR CABLE mm	CLEARANCE HOLE, PG
MFM 8-12	3x6-10, 3x10-14	M50 50,5



Membrane cable glands
Flame resistance UL 96-V2
Grey RAL 7035
Temperature range
-50°C → +70°C
Fet 5-7 for cables 5-7 ø
Fet 7-10 for cables 7-10 ø etc.

ORDER SYMBOL	FOR CABLE mm	CLEARANCE HOLE, PG
FET 5-7	5-7	PG 9
FET 7-10	7-10	PG 11
FET 8-14	8-14	PG 16
FET 14-20	14-20	PG 21
FET 20-26	20-26	PG 29
FET 26-35	26-35	PG 36

ROOF



Cover = **EKH 30 T (G)**



Cover = **EKJ 30 T (G)**



Cover = **EKM 30 T (G)**



Cover = **EKO 30 G (T)**



Cover = **EKP 30 T (G)**



Cover = **EKP 30 T (G)**



Cover = **EKT 30 G (T)**



Cover = **EKT 30 T (G)**



Cover = **EKW 100 G**

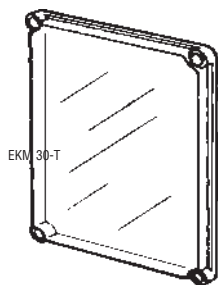

Eight sizes of base and cover.
Three depths for cover 30, 80, 100 mm.
Note! (EKW only with grey colour)
Note! Order cover screws against the cover height.

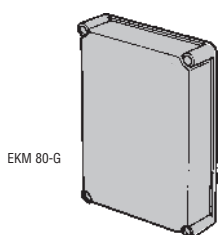

EK-covers (PC)
G=grey cover RAL 7035
T=transparent cover
Height 30 mm.

EK-covers (PC)
G=grey cover RAL 7035
T=transparent cover
Height 80 mm.

More space with extension frames

ORDER SYMBOL	SIZE mm
EKH 30-T	190x190x30
EKH 30-G	190x190x30
EKJ 30-T	280x190x30
EKJ 30-G	280x190x30
EKM 30-T	380x190x30
EKM 30-G	380x190x30
EKO 30-T	280x280x30
EKO 30-G	280x280x30
EKP 30-T	380x280x30
EKP 30-G	380x280x30
EKT 30-T	560x280x30
EKT 30-G	560x280x30
EKU 30-T	560x380x30
EKU 30-G	560x380x30

EKH 80-T	190x190x80
EKH 80-G	190x190x80
EKJ 80-T	280x190x80
EKJ 80-G	280x190x80
EKM 80-T	380x190x80
EKM 80-G	380x190x80
EKO 80-T	280x280x80
EKO 80-G	280x280x80
EKP 80-T	380x280x80
EKP 80-G	380x280x80
EKW 100-G	760x560x100

HINGED COVER

FIBOX COVERS WITH READY ASSEMBLED FSH HINGES

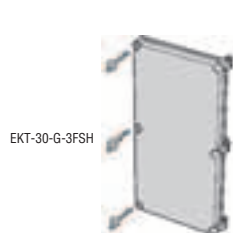

Low cover 30 mm.
G=grey cover RAL 7035
T=transparent cover

EKT-30-G-3FSH

Incl. cover and 2 pcs or 3 pcs HS-wing head (2FSH/3FSH) screws.



High cover 80 mm.
G=grey cover RAL 7035
T=transparent cover

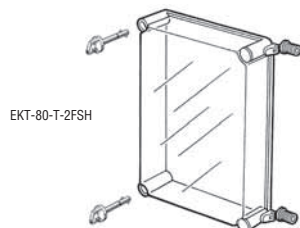

EKT-80-T-2FSH

ORDER SYMBOL	SIZE mm
EKH 30-G-2FSH	190x190x30
EKH 30-T-2FSH	190x190x30
EKJ 30-G-FSH19	190x280x30
EKJ 30-T-FSH19	190x280x30
EKJ 30-G-2FSH	280x190x30
EKJ 30-T-2FSH	280x190x30
EKM 30-G-2FSH	380x190x30
EKM 30-T-2FSH	380x190x30
EKO 30-G-2FSH	280x280x30
EKO 30-T-2FSH	280x280x30
EKP 30-G-2FSH	380x280x30
EKP 30-T-2FSH	380x280x30
EKT 30-G-3FSH	560x280x30
EKT 30-T-3FSH	560x280x30
EKU 30-G-3FSH	560x380x30
EKU 30-T-3FSH	560x380x30

EKH 80-G-2FSH	190x190x80
EKH 80-T-2FSH	190x190x80
EKJ 80-G-2FSH	280x190x80
EKJ 80-T-2FSH	280x190x80
EKM 80-G-2FSH	380x190x80
EKM 80-T-2FSH	380x190x80
EKO 80-G-2FSH	280x280x80
EKO 80-T-2FSH	280x280x80
EKP 80-G-2FSH	380x280x80
EKP 80-T-2FSH	380x280x80

HINGES, BLIND PLUG

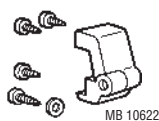

MB 10622















MB 10523

PC hinge set, 1 pair, incl. screws and drill template
PA hinge set, 1 pair, incl. screws
Template for MB 10547 in plastic
Blind plug for cover corner on hinged side when cover screws are not used

ORDER SYMBOL	SIZE mm
MB 10622	30/80
MB 10547	30/80
PA 10547	
MB 10523	

ROOF

COVERS SCREWS

	ORDER SYMBOL	FOR COVERS
 Wing head screw	HS 10255	30
 Slotted head screw, sealable	SS 10535	30
 Triangle head screw	DS 10581	30/80/100
 Cross head screw	CS 10256	30/100
 Slotted head screw, quick-lock, *)	SS 10544	30/100
 Wing head screw, quick-lock, *)	HS 10533	30
 Quick-locking wing head screw, hinged, *)	HS 10532	30
 *) Threaded bushing	MB 10534	
 *) Threaded bushing (needed for quick-locking screws)		
 Cross head screw	SS 10563	80
 Wing head screw	HS 10562	80
 Noryl slotted head screw (good chemical resistance)	SS 10256N	30
 Noryl wing head screw (good chemical resistance)	HS 10255N	30
Set of four cross head screws	SS 10256-4	30/100
Set of six cross head screws	SS 10256-6	30/100
Set of four cross head screws	SS 10563-4	80



L 12 clear

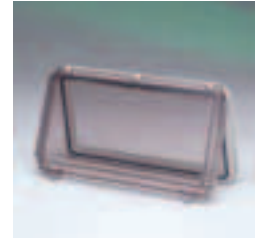

L 12 II transparent smoked grey



L 13 clear



SOLID FRAME application



L 24 clear



L 44 II transparent smoked grey

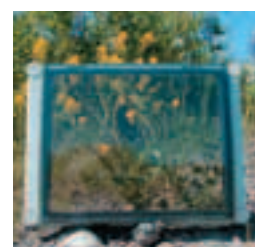

L 43 II transparent smoked grey

SOLID FRAME

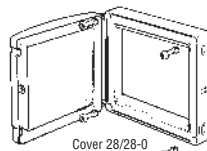
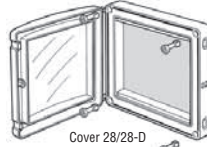
	ORDER SYMBOL	SIZE mm
 Frame, with opening	Cover 28/28-0	280x280
Front plate aluminium	FP 28/28	
 Frame, no opening	Cover 28/28-D	280x280
Key lock set	MR 26065	





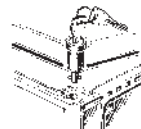



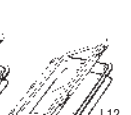

Solid Frames also fit EKOE and SOLID 2828 beses.

KEY-LOCK SET

	ORDER SYMBOL
 Key-lock set incl., lock and 2 keys for 30 mm covers	MB 10597

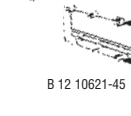
INSPECTION WINDOWS

The order symbol indicates the amount of the DIN modules for example L08=8 modules.

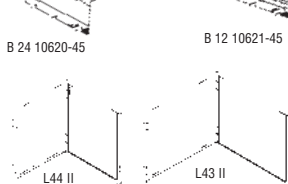
	ORDER SYMBOL	SIZE mm
 Windows, IP 65	L12 II	248x128
 Windows, IP 65	L24 II	248x128
 Windows, IP 65	L12	248x128
 Windows, IP 65	L24	248x128
 Windows, IP 65	L13	257x108
 Windows, IP 54	L10	199x77
 Windows, IP 54	L08	162x77
 Windows, IP 54	L06	130x77
 Windows, IP 54	L04	96x77
 Windows, IP 54	L02	60x77
 Front plates for L 12 windows	B12 10621-45	
 Front plates for L 24 windows	B24 10620-45	
 Large size windows, IP 65, for enclosure EKW 100-G	L44 II	377x331
	L43 II	331x277

DIMENSIONAL DRAWINGS

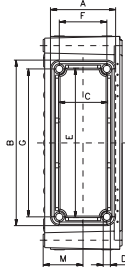

FLANGE OPENINGS								
Plate size	Dimensions							
	A	B	C	D	E	F	G	M
1	48	138	33	7	121	30	120	31
2	86	217	63	9,5	195	62	193	52
3	127	332	101	11,5	306	80	292	71

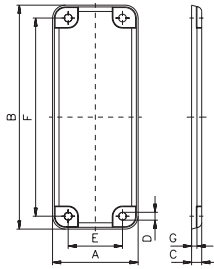

COVER PLATES								
Order symbol	Plate size	Dimensions						
		A	B	C	D	E	F	G
MB 10215	1	49	140,5	10	7	30	120	5
MB 10546	2	85	217	10	9,5	62	193	5
MB 10324	3	127	332	15	11,5	80	292	8

TECHNICAL INFORMATION

PROPERTY	POLYCARBONATE (PC)	CONFORMITY TO STANDARDS
Ingress Protection (EN 60529)	IP66/IP67	USA Enclosures for Electrical Equipment PC: UL Type 1, 3, 3S, 4, 4X, 6, 6P and 12 (UL 50/508)
Impact Resistance (EN 50102)	IK 08	Canada Industrial Control Equipment Enclosures for Electrical Equipment/ULc
Temperature Range (short term)	Celsius: -40° .. 120°C Fahrenheit: -40° .. 250°F	Europe Enclosures for Switch Gear and Control Gear Assemblies EN 50298:1998
Temperature Range (continuous)	Celsius: -40° .. 80°C Fahrenheit: -40° .. 175°F	Europe Safety of Information Technology Equipment EN 60950
Electrical Insulation	Totally insulated <input type="checkbox"/>	Australia Enclosures for switch gear and control gear AS 3132-1991
Light Grey Parts Colour	RAL 7035	DNV PC: DNV Rules for Classification of Ships and Mobile Offshore Units
Transparent Clear PC Cover	Industry Grey	GL PC: GL Regulations for the Performance of Type Test, Part 1
Cover Screws	Clear Transparent	
Cover Screws	RAL 7035	
Gasket	Polyamide (PA)	LR Marine offshore and industrial installations
Enclosure Flammability Rating	PUR	BV BV Rules
Glow Wire Test	UL94-5V	UL 746 C 5 in. vertical flame test
Non-toxicity	960°C	IEC 695-2-1, Self-extinguishing
UV resistance	Halogen Free	DIN/VDE 0472, Part 815
Chemical Resistance *	UL 508	CE, FI -mark
	720 hours in "Weatherometer"	
	Good	

Data subject to change without notice. *Consult separate raw material data for more detailed information

NEW!

EK enclosure sets

Some most popular EK sizes are now available as complete enclosures with just one order symbol. Sets include base, cover and cover screws. Naturally same wide SOLID/EK accessory range allows you to customise these "easy-to-order" sets to your needs.

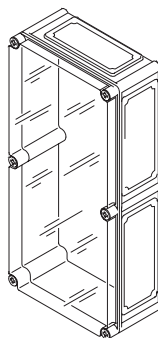

EKTH 130 T

ORDER SYMBOL	SIZE mm
EKHA 130 G	190x190x130
EKJB 130 G	280x190x130
EKMB 130 G	380x190x130
EKOE 130 G	280x280x130
EKPE 130 G	380x280x130
EKTH 130 G	560x280x130
EKUH 180 G	560x380x180
EKWH 250 G	760x560x250
EKHA 130 T	190x190x130
EKJB 130 T	280x190x130
EKMB 130 T	380x190x130
EKOE 130 T	280x280x130
EKPE 130 T	380x280x130
EKTH 130 T	560x280x130
EKUH 180 T	560x380x180

X-ON Electronics

Largest Supplier of Electrical and Electronic Components

Click to view similar products for [fibox manufacturer](#):

Other Similar products are found below :

[MPS ARCA 5040](#) [PCM 175/75 T](#) [ABQ3 364015](#) [EKMVT](#) [CAB ABSQ 302017G](#) [CAB P 302017](#) [CAB PC 303018 G3B](#) [CAB PCQ 404017 T](#)
[ABS 150/125 HG](#) [PCT 081206](#) [CAB ABS 302018 G](#) [CAB PC 303018 T3B](#) [CAB PCQ 303017 T](#) [CAB PCQ 404017 G](#) [PC 5628 13 T](#) [TAM](#)
[090706 MC](#) [ARCA 705030](#) [ARCA 406021](#) [MP 6040](#) [ARCA 405021](#) [ARCA 507030](#) [ARCA 604021](#) [ARCA 806030](#) [EKOE 130 G](#) [2539543](#)
[DRS ARCA 403015](#) [DRS ARCA 304021](#) [DRS ARCA 302015](#) [DRS ARCA 203015](#) [PC 100/125 HG](#) [PC 100/75 HT](#) [PC 300/150 ZG](#) [PCM](#)
[175/150 G](#) [PCM 125/100 G](#) [PC 125/125 HG](#) [PC 200/63 HT](#) [ABS D 65 G](#) [CAB PC 302018 G](#) [CAB ABSQ 403017 G](#) [CAB PC 302018 G3B](#)
[7094450](#) [PC 1919 13 T-2FSH](#) [PC 200/150 HT](#) [9821007](#) [EKPE 130 G ENCLOSURE](#) [ABS C 85 G](#) [FEX 3828 18 T ENCLOSURE](#) [FP 12017](#)
[SET](#) [CAB PC 302018 G CABINET](#) [EKIV 33 MOUNTING PLATE](#)