

ANNA-B112

Stand-alone Bluetooth 5 low energy module

Data Sheet

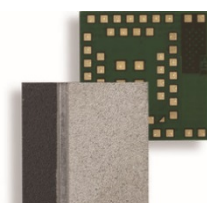

Abstract

This technical data sheet describes the ultra-compact ANNA-B112 stand-alone Bluetooth® 5 low energy module packed into a System-in-Package design. Despite the small size, ANNA-B112 offers the internal antenna option. With embedded Bluetooth low energy stack and u-blox connectivity software, this SiP module is tailored for OEMs who wish to have the shortest time-to-market. ANNA-B112 offers full flexibility and the OEMs can embed their own application on top of the integrated Bluetooth low energy stack using Nordic SDK or Arm® Mbed™ integrated development environment (IDE).

Document Information

Title	ANNA-B112	
Subtitle	Stand-alone Bluetooth 5 low energy module	
Document type	Data Sheet	
Document number	UBX-18011707	
Revision and date	R04	24-Dec-2018
Disclosure Restriction		

Product status	Corresponding content status	
Functional Sample	Draft	For functional testing. Revised and supplementary data will be published later.
In Development / Prototype	Objective Specification	Target values. Revised and supplementary data will be published later.
Engineering Sample	Advance Information	Data based on early testing. Revised and supplementary data will be published later.
Initial Production	Early Production Information	Data from product verification. Revised and supplementary data may be published later.
Mass Production / End of Life	Production Information	Document contains the final product specification.

This document applies to the following products:

Product name	Type number	u-blox connectivity software version	PCN reference	Product status
ANNA-B112	ANNA-B112-00B-00	1.0.0	N/A	Initial Production

u-blox or third parties may hold intellectual property rights in the products, names, logos and designs included in this document. Copying, reproduction, modification or disclosure to third parties of this document or any part thereof is only permitted with the express written permission of u-blox.

The information contained herein is provided "as is" and u-blox assumes no liability for its use. No warranty, either express or implied, is given, including but not limited to, with respect to the accuracy, correctness, reliability and fitness for a particular purpose of the information. This document may be revised by u-blox at any time without notice. For the most recent documents, visit www.u-blox.com.

Copyright © u-blox AG.

Contents

Document Information	2
Contents	3
1 Functional description	6
1.1 Overview	6
1.2 Product features	6
1.3 Block diagram	7
1.4 Product description	8
1.5 Software options	8
1.5.1 u-blox connectivity software	8
1.5.2 Open CPU.....	9
1.6 Bluetooth device address	9
2 Interfaces	10
2.1 Power management	10
2.1.1 Module supply input (VCC)	10
2.2 RF antenna interfaces	10
2.2.1 2.4 GHz Bluetooth low energy (ANT)	10
2.2.2 Near Field Communication (NFC).....	10
2.3 Low Power Oscillator interface.....	10
2.4 System functions	11
2.4.1 Module power-on	11
2.4.2 Module power-off.....	11
2.4.3 Standby mode	11
2.4.4 Sleep mode.....	12
2.4.5 Module reset	12
2.4.6 Real Time Counter (RTC).....	12
2.5 Serial interfaces	12
2.5.1 Asynchronous serial interface (UART)	13
2.5.2 Serial peripheral interface (SPI)	13
2.5.3 I ² C interface	13
2.5.4 I ² S interface	14
2.6 GPIO	14
2.6.1 PWM.....	14
2.7 Analog interfaces	15
2.7.1 ADC.....	15
2.7.2 Comparator	15
2.7.3 Low power comparator	15
2.7.4 Analog pin options	15
2.8 u-blox connectivity software features	15
2.8.1 u-blox Serial Port Service (SPS)	15
2.8.2 System status signals.....	16

2.8.3	System control signals	16
2.8.4	UART signals	16
2.8.5	IO signals	16
2.9	Debug interfaces	17
2.9.1	SWD.....	17
2.9.2	Trace – Serial Wire Viewer.....	17
3	Pin definition	18
3.1	Pin assignment open CPU.....	18
3.2	Pin assignment in the u-blox connectivity software	21
4	Electrical specifications	24
4.1	Absolute maximum ratings	24
4.1.1	Maximum ESD ratings.....	24
4.2	Operating conditions	24
4.2.1	Operating temperature range.....	24
4.2.2	Supply/Power pins	25
4.2.3	Current consumption.....	25
4.2.4	RF performance	25
4.2.5	ANNA-B112 radiation patterns	26
4.2.6	RESET_N pin	28
4.2.7	Digital pins.....	28
5	Mechanical specifications	29
6	Qualification and approvals.....	30
6.1	Country approvals.....	30
6.2	European Union regulatory compliance	30
6.2.1	Radio Equipment Directive (RED) 2014/53/EU	30
6.2.2	Compliance with the RoHS directive	30
6.3	FCC and IC Compliance.....	30
6.3.1	FCC compliance	31
6.3.2	RF-exposure statement	31
6.3.3	End product user manual instructions.....	32
6.3.4	End product labeling requirements	32
6.3.5	FCC and IC IDs	33
6.3.6	End product compliance.....	33
6.4	Japan radio equipment compliance	34
6.4.1	Compliance statement.....	34
6.4.2	End product labelling requirement.....	34
6.4.3	End product user manual requirement	34
6.5	NCC Taiwan compliance	35
6.5.1	Taiwan NCC Warning Statement.....	35
6.5.2	ANNA-B112 labeling requirements for end product	35
6.6	Safety compliance	35
6.7	Bluetooth qualification information	35

7	Antennas	36
7.1	Approved antennas	36
8	Product handling	39
8.1	Packaging	39
8.2	Reels	39
8.3	Tapes	40
8.4	Moisture sensitivity levels.....	40
8.5	Reflow soldering	41
8.6	ESD precautions.....	41
9	Marking and ordering information	42
9.1	Product marking.....	42
9.2	Explanation of codes	42
9.3	Ordering information.....	43
	Appendix	44
A	Glossary	44
	Related documents	45
	Revision history	45
	Contact	46

1 Functional description

1.1 Overview

The ANNA-B112 is an ultra-small, high-performing, standalone Bluetooth low energy module. The System in Package (SiP) module features Bluetooth 5, a powerful Arm® Cortex®-M4 microprocessor with FPU, and state-of-the-art power performance. The ANNA-B112 is delivered with u-blox connectivity software that provides support for u-blox Bluetooth low energy Serial Port Service, GATT client and server, beacons, NFC™, and simultaneous peripheral and central roles – all configurable from a host by using AT commands.

The ANNA-B112 module also includes an integrated antenna providing a range of 160 m, and an antenna pin for design-in of an external antenna.

ANNA-B112 has full modular approval for Europe (RED), US (FCC), Canada (IC / ISED RSS), Japan (MIC), Taiwan (NCC), South Korea (KCC)¹, Australia / New Zealand (ACMA)¹, Brazil (Anatel)¹, South Africa (ICASA)¹.

1.2 Product features

Model		Radio						Interfaces				Power			Features						Grade				
	Software application	Bluetooth® qualification	Bluetooth profiles	NFC for "Touch to Pair"	Antenna type	Maximum radiated output power (EIRP) [dBm]	Maximum range [m]	UART	SPI and I ² C	GPIO pins	AD converters (ADC)	Power supply: 1.7- 3.6 VDC	Current consumption, sleep [µA]	Current consumption, Tx @ 0 dBm [mA]	u-blox Low Energy Serial Port Service	GATT server and GATT client	Throughput [Mbit/s]	AT command support	IPV6	Mesh networking	Max simultaneous connections	Over-the-air firmware update	Standard	Professional	Automotive
ANNA-B112	uCS ¹	v5.0	G	•	I P	5 8	160 190	•	11		•	0.3	5	•	•	0.8	•		7			•			
	Open CPU ²	v5.0	G	•	I P	5 8	160 190	•	•	25	8	•	0.3	5	•	1.4	•	•	•	20	•	•			

1 = u-blox connectivity software / P = antenna pin / I = internal antenna / G = GATT
 2 = open CPU for embedded customer developed applications using Nordic SDK, Arm® Mbed™ or Wirepas Mesh SDK

Table 1: ANNA-B112 main features summary

¹ Approvals are pending.

1.3 Block diagram

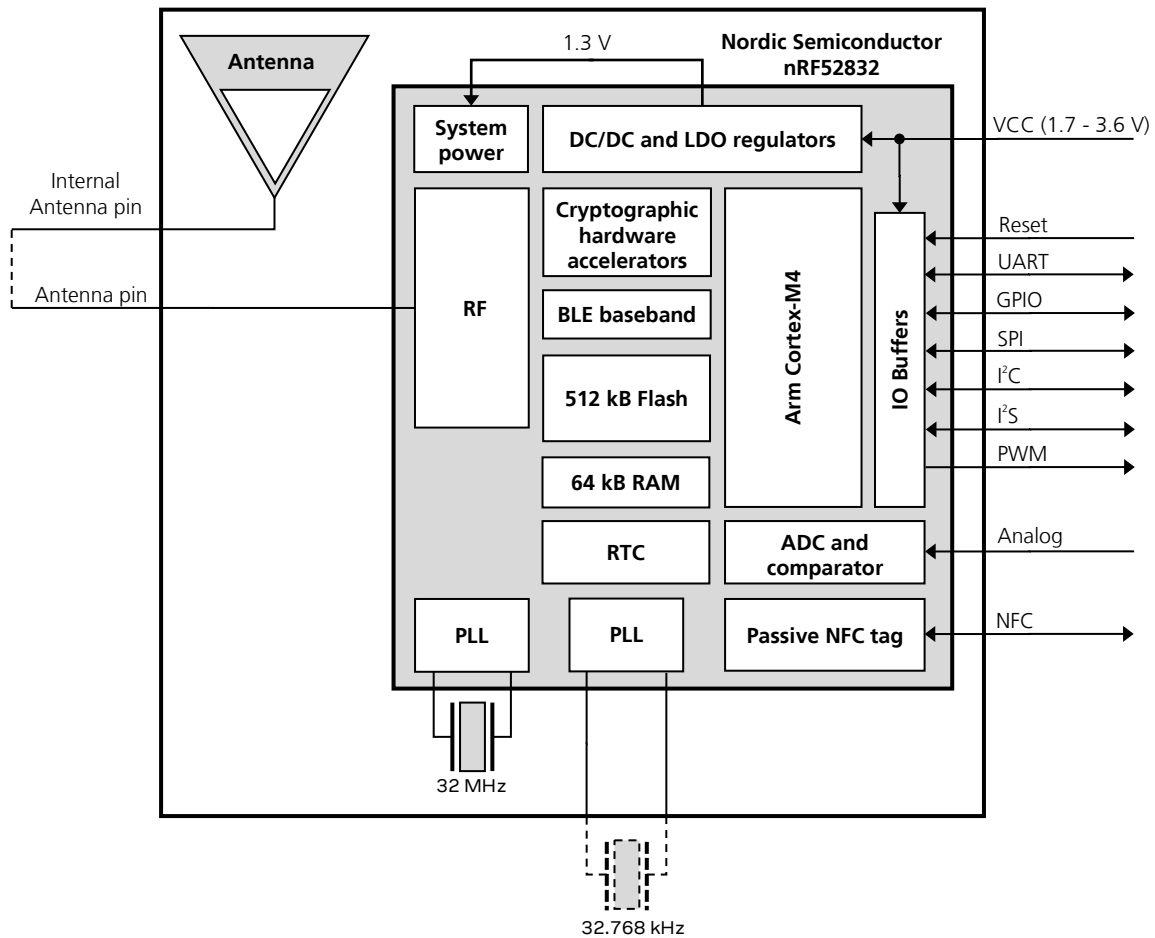

Figure 1: Block diagram of ANNA-B112

The ANNA-B112 SiP module has an integrated antenna. The RF signal pin can either be connected directly to the adjacent antenna pin to use the internal antenna or routed to an external antenna or antenna connector.

The module does not have its own low power oscillator (LPO) and depending on the power supply requirement, you could connect an external LPO crystal or oscillator.

An integrated DC/DC converter is used for higher efficiency under heavy load situations. See section 2.1.1 for more information.

1.4 Product description

Item	ANNA-B112
Bluetooth version	5.0
Band support	2.4 GHz, 40 channels
Typical conducted output power	+4 dBm
Max radiated output power with internal antenna (EIRP)	+5 dBm
Max radiated output power with external antenna (EIRP)	+9 dBm
Sensitivity (conducted)	-91 dBm
Best sensitivity with internal antenna (EIRP)	-92 dBm
Best sensitivity with external antenna (EIRP)	-96 dBm
Data rates	1 and 2 Mbps GFSK
Module size	6.5 x 6.5 x 1.2 mm

Table 2: ANNA-B112 characteristics summary

1.5 Software options

The integrated application processor of the ANNA-B112 module is an Arm Cortex-M4 with FPU that has 512 kB flash memory and 64 kB RAM. The software structure of any program running on the module can be broken down into the following components:

- Radio stack
- Bootloader (optional)
- Application

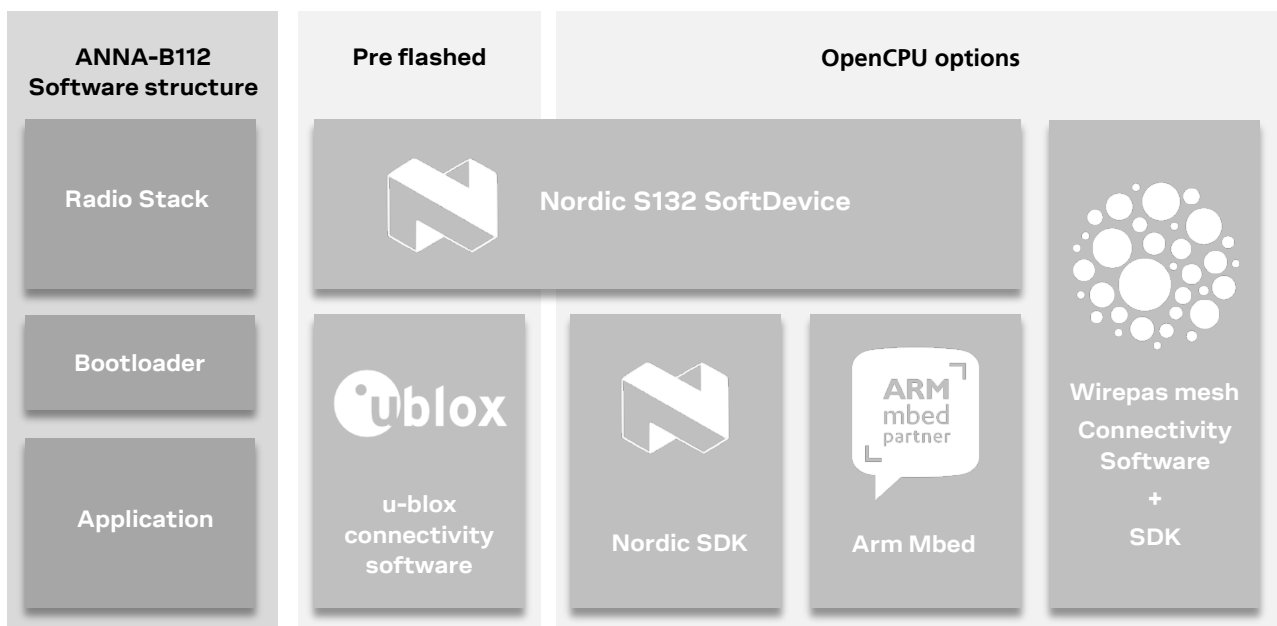

Figure 2: ANNA-B112 software structure and available software options

More information on each option can be found in the ANNA-B112 System Integration Manual [1].

1.5.1 u-blox connectivity software

The ANNA-B1 module is preflashed with u-blox connectivity software.

The u-blox connectivity software enables the use of the u-blox Low Energy Serial Port Service, controlled by AT commands over the UART interface. You can configure ANNA-B112 modules

through u-blox s-center software or by using the AT commands. The s-center evaluation software can be downloaded from the u-blox website and is available free of charge.

More information on the features and capabilities of the u-blox Low Energy Serial Port Service and how to use this can be found in the ANNA-B112 Getting Started Guide [3] and the u-blox Short Range AT commands manual [2].

1.5.2 Open CPU

A custom application can be embedded in the ANNA-B112 module. The supported development environments are described below.

Nordic SDK

The Nordic nRF5 SDK provides a rich and well tested software development environment for nRF52-based devices. It includes a broad selection of drivers, libraries, and example applications.

Arm Mbed OS

Arm Mbed OS is an open source embedded operating system designed specifically for the "things" in the Internet of Things. It includes all features to develop a connected product, including security, connectivity, an RTOS, and drivers for sensors and I/O devices. The u-blox ANNA-B112 module fully supports Mbed OS 5.

Wirepas Mesh stack

The ANNA-B112 modules can also be used together with the Wirepas Mesh stack. This will enable the ANNA-B1 module to be used in a large-scale mesh environment.

The Wirepas mesh stack is a third party licensed software from Wirepas.

For more information about the Wirepas mesh stack, contact the u-blox support for your area as listed in the Contact section or Wirepas directly.

1.6 Bluetooth device address

Each ANNA-B1 module is preprogrammed with a unique 48-bit Bluetooth device address.

2 Interfaces

2.1 Power management

2.1.1 Module supply input (VCC)

The ANNA-B112 uses an integrated step-down converter to transform the supply voltage presented at the **VCC** pin into a stable system voltage. Due to this, the ANNA-B112 modules are compatible for use in battery powered designs without the use of an additional voltage converter. You can choose one of the following two on-board voltage converter options:

- A low-dropout (LDO) converter
- A DC/DC buck converter

Normally, the module will automatically switch between these options depending on the current consumption. Under high loads such as when the radio is active, the DC/DC converter is more efficient, while the LDO converter is more efficient in the power saving modes. It is possible to configure the module to use only the LDO mode, if needed.

2.2 RF antenna interfaces

2.2.1 2.4 GHz Bluetooth low energy (ANT)

The ANNA-B112 2.4 GHz antenna interface can be used in one of the following two ways as mentioned below:

1. With an external antenna or antenna connector: The ANNA-B112 modules provide an antenna pin (**ANT**) with a nominal characteristic impedance of 50 Ω . This pin can be connected to a carrier board antenna or antenna connector using a controlled impedance trace. See the ANNA-B112 System Integration Manual [1] for more information. OR
2. With the internal antenna: The ANNA-B112 module has an onboard integrated antenna. To use this antenna, the internal antenna pin (**ANT_INT**) has to be connected directly to the **ANT** pin (adjacent to the **ANT_INT** pin). The ANT pins shall not be connected anywhere else in this case and no additional antenna or RF component is needed. Also the connection to the **ANT_PCB**, **ANT_GND1** and **ANT_GND2** pins need to be designed correctly see the ANNA-B112 System Integration Manual [1] for more information.

2.2.2 Near Field Communication (NFC)

The ANNA-B112 modules include a Near Field Communication interface, capable of operating as a 13.56 MHz NFC tag at a bit rate of 106 kbps. As an NFC tag, data can be read from or written to the ANNA-B112 modules using an NFC reader; however the ANNA-B112 modules are not capable of reading other tags or initiating NFC communications. Two pins are available for connecting to an external NFC antenna: **NFC1** and **NFC2**. See the ANNA-B112 System Integration Manual [1] for more information and NFC antenna design considerations.

2.3 Low Power Oscillator interface

During standby mode, the module needs a 32.768 kHz clock source (accuracy +/- 250 ppm or better). Several clock options are available for the ANNA-B112 module as specified in Table 3:

Source	Current consumption	Comment
External 32.768kHz crystal	300 nA	Connected to the XL1 and XL2 pins (see chapter 3).
Internal RC oscillator	620 nA + calibration	Needs recalibration every 8 s
External 32.768 kHz clock signal	-	Connected to the XL1 pin (see chapter 3).

Table 3: Supported low power clock sources for ANNA-B112

See the ANNA-B112 System Integration Manual [1] for more information about the different 32.768 kHz clock source alternatives.

2.4 System functions

The ANNA-B112 modules are power efficient devices capable of operating in different power saving modes and configurations. Different sections of the module can be powered off when not needed and complex wake up events can be generated from different external and internal inputs. The radio part of the module operates independently from the CPU.

The two main power saving modes are:

- Standby mode
- Sleep mode

Depending on the application, the module should spend most of its time in sleep mode to conserve battery life.

2.4.1 Module power-on

ANNA-B112 modules can be switched on in one of the following ways and this will cause the module to reboot:

- Rising edge on the VCC pin to a valid supply voltage
- Issuing a reset of the module

A wake up event from sleep mode to active mode can be issued by:

- Changing the state of any digital I/O pin, may be enabled /disabled for each pin.

If waking up from standby mode, an event can also be issued by:

- The on-board Real Time Counter (RTC)
- A programmable digital or analog sensor event. For example, rising voltage level on an analog comparator pin

2.4.2 Module power-off

There is no dedicated pin to power off the ANNA-B112 modules. You can configure any GPIO pin to enter or exit the sleep mode (see section 2.4.4), which essentially powers down the module.

An under-voltage (brown-out) shutdown occurs on ANNA-B112 modules when the **VCC** supply drops below the operating range minimum limit. If this occurs, it is not possible to store the current parameter settings in the module's non-volatile memory. An over-temperature and under-temperature shutdown can be enabled on ANNA-B112 modules, and is initiated if the temperature measured within the module is outside operating conditions. The temperature is measured by an integrated temperature sensor in the radio chip. For more details see the ANNA-B112 System Integration Manual [1].

2.4.3 Standby mode

Standby mode is one of the power saving modes in ANNA-B112 modules that essentially powers down the module but keeps the system RAM intact and allows for a few low power digital interfaces (including SPI) and analog functions to run continuously. It also allows for complex, autonomous power-up events including periodic RTC events and radio events.

The following events can be used to bring the module out of the standby mode:

- External wake-up events
- Internal wake-up events from RTC, radio, NFC and so on
- Analog or digital sensor event (programmable voltage level or edge detection)

 During standby mode, the module needs a 32.768 kHz clock source. See section 2.3 for more information about the different alternatives for the 32.768 kHz clock source.

2.4.4 Sleep mode

Sleep mode is the deepest power saving mode of ANNA-B112 modules. During sleep mode, all functionality is stopped to ensure minimum power consumption. The module needs an external event in order to wake up from sleep mode.

The following events can be used to wake up the module out of the sleep mode:

- External event on a digital pin
- External event on a low power comparator pin
- Detection of NFC field

When using the u-blox connectivity software, the module can be manually switched on or off with proper storage of current settings using the UART **DSR** pin.

The module can be programmed to latch the digital values present at its GPIO pins during sleep. The module will keep the values latched, and a change of state on any of these pins will trigger a wake up to active mode.

The module will always reboot after waking up from the sleep mode; however different sections of the RAM can be configured to remain intact during and after going into the sleep mode.

2.4.5 Module reset

ANNA-B112 modules can be reset in one of the following ways:

- Low level on the RESET_N input pin, normally high with internal pull-up. This causes an “external” or “hardware” reset of the module. The current parameter settings are not saved in the module’s non-volatile memory and a proper network detach is not performed.
- Using the AT+CPWROFF command. This causes an “internal” or “software” reset of the module. The current parameter settings are saved in the module’s non-volatile memory and a proper network detach is performed.

2.4.6 Real Time Counter (RTC)

A key system feature available on the module is the Real Time Counter. This counter can generate multiple interrupts and events to the CPU and radio as well as internal and external hardware blocks. These events can be precisely timed ranging from microseconds up to hours, and allows for periodic BLE advertising events etc., without involving the main CPU. The RTC can be operated in power-on and standby modes.

 During standby mode, the module needs a 32.768 kHz clock source. See section 2.3 for more information about connecting an external 32.768 kHz clock source.

2.5 Serial interfaces

ANNA-B112 modules provide the following serial communication interfaces:

- 1x UART interface: 4-wire unbalanced asynchronous serial interface used for AT commands interface, data communication and u-blox connectivity software upgrades using the FOAT feature.
- 3x SPI interfaces: Up to three serial peripheral interfaces can be used simultaneously.

- 2x I2C interfaces: Inter-Integrated Circuit (I2C) interface for communication with digital sensors.

 Radio performance parameters such as sensitivity, may be affected by high frequency on some of the digital I/O with large sink/source current. See low frequency pins in Table 7 for additional information.

 All digital interface pins on the module are shared between the digital and analog interfaces and GPIOs. Any function can be assigned to any pin that is not already occupied.

2.5.1 Asynchronous serial interface (UART)

The UART interface supports hardware flow control and baud-rates up to 1 Mbps. Other characteristics of the UART interface are listed below:

- Data lines (RXD as input, TXD as output) and hardware flow control lines (CTS as input, RTS as output) are provided.
- Hardware flow control (default) or no flow control is supported.
- Power saving indication available on the hardware flow control output (CTS line): The line is driven to the OFF state when the module is not ready to accept data signals.
- Programmable baud-rate generator allows most industry standard rates, as well as non-standard rates up to 1 Mbps.
- Frame format configuration:
 - 8 data bits
 - Even or no-parity bit
 - 1 stop bit
- Default frame configuration is 8N1, meaning eight (8) data bits, no (N) parity bit, and one (1) stop bit.

 Radio performance parameters such as sensitivity, may be affected by high frequency on some of the digital I/O with large sink/source current. See low frequency pins in Table 7 for additional information.

2.5.2 Serial peripheral interface (SPI)

ANNA-B112 supports up to 3 Serial Peripheral Interfaces that can operate in both master and slave mode with a maximum serial clock frequency of 8 MHz in both master and slave modes. The SPI interfaces use 4 signals: **SCLK**, **MOSI**, **MISO** and **CS**. When using the SPI interface in master mode, it is possible to use GPIOs as additional Chip Select (CS) signals to allow addressing of multiple slaves.

 Radio performance parameters such as sensitivity, may be affected by high frequency on some of the digital I/O with large sink/source current. See low frequency pins in Table 7 for additional information.

2.5.3 I²C interface

The Inter-Integrated Circuit interfaces can be used to transfer or receive data on a 2-wire bus network. The ANNA-B112 modules can operate as both master and slave on the I²C bus using both standard (100 kbps) and fast (400 kbps) transmission speeds. The interface uses the **SCL** signal to clock instructions and data on the **SDL** signal.

 Radio performance parameters such as sensitivity, may be affected by high frequency on some of the digital I/O with large sink/source current. See low frequency pins in Table 7 for additional information.

2.5.4 I²S interface

The Inter-IC Sound (I²S) interface can be used to transfer audio sample streams between ANNA-B112 and external audio devices such as codecs, DACs, and ADCs. It supports original I²S and left or right-aligned interface formats in both master and slave mode. It uses up to 5 signals: Master clock (**MCK**), Left right clock or Word clock (**LRCK**), Serial clock (**SCK**), Serial data in (**SDIN**) and Serial data out (**SDOUT**). The Master side of the interface always provides the **LRCK** and **SCK** clock signals, but as an addition ANNA-B112 can supply a **MCK** clock signal in both master and slave mode to provide to external systems that cannot generate their own clock signal. The two data signals - **SDIN** and **SDOUT** allow for simultaneous bi-directional audio streaming. The interface supports 8, 16 and 24-bit sample widths with up to 48 kHz sample rate.

 Radio performance parameters such as sensitivity, may be affected by high frequency on some of the digital I/O with large sink/source current. See low frequency pins in Table 7.

2.6 GPIO

The ANNA-B112 modules are versatile concerning pin-out. If un-configured, there will be 25 GPIO pins in total and no analog or digital interfaces. All digital interfaces or functions must then be allocated to a GPIO pin before use. 8 out of the 25 GPIO pins are analog enabled thus they can have an analog function allocated to them. In addition to the serial interfaces, Table 4 shows the number of digital and analog functions that can be assigned to a GPIO pin.

 The pins dedicated to the NFC antenna function (**NFC1** and **NFC2**) will have some limitation when the pins are configured for normal GPIO operation. The pin capacitance will be higher on those, and you can expect some increased leakage current between the two pins if they are used in GPIO mode and are driven to different logical values. To save power, the two pins should always be set to the same logical value whenever entering one of the device power saving modes. See section 4.2.7 for more information.

Function	Description	Default ANNA pin	Configurable GPIOs
General purpose input	Digital input with configurable edge detection and interrupt generation		Any
General purpose output	Digital output with configurable drive strength, pull-up, pull-down, open-source, open-drain and/or slew rate		Any
Pin disabled	Pin is disconnected from input buffers and output drivers.	All*	Any
Timer/ counter	High precision time measurement between two pulses/ Pulse counting with interrupt/event generation		Any
Interrupt/ Event trigger	Interrupt/event trigger to the software application/ Wake up event		Any
ADC input	8/10/12-bit analog to digital converter		Any analog
Analog comparator input	Compare two voltages, capable of generating wake-up events and interrupts		Any analog
PWM output	Output complex pulse width modulation waveforms		Any
Connection status indication	Indicates if a BLE connection is maintained	BLUE**	Any

* = If left unconfigured

** = If using the u-blox connectivity software

Table 4: GPIO custom functions configuration

2.6.1 PWM

The ANNA-B112 modules provide up to 12 independent PWM channels that can be used to generate complex waveforms. These waveforms can be used to control motors, dim LEDs and as audio

signals, if connected to speakers. Duty-cycle sequences may be stored in RAM to be chained and looped into complex sequences without CPU intervention. Each channel uses a single GPIO pin as output.

2.7 Analog interfaces

8 out of the 25 digital GPIOs can be multiplexed to analog functions. The following analog functions are available for use:

- 1x 8-channel ADC
- 1x Analog comparator*
- 1x Low-power analog comparator*

*Only one of the comparators can be used simultaneously.

2.7.1 ADC

The Analog to Digital Converter (ADC) can sample up to 200 kHz using different inputs as sample triggers. It supports 8/10/12-bit resolution. Any of the 8 analog inputs can be used both as single-ended inputs and as differential pairs for measuring the voltage across them. The ADC supports full 0 V to VCC input range.

2.7.2 Comparator

The comparator compares voltages from any analog pin with different references as shown in Table 5. It supports full 0 V to VCC input range and can generate different software events to the rest of the system.

2.7.3 Low power comparator

The low-power comparator operates in the same way as the normal comparator, with some reduced functionality. It can be used during sleep mode as a wake up source.

2.7.4 Analog pin options

Table 5 shows the supported connections of the analog functions.



An analog pin may not be simultaneously connected to multiple functions.

Analog function	Can be connected to
ADC single-ended input	Any analog pin or VCC
ADC differential input	Any analog pin or VCC pair
Comparator IN+	Any analog pin
Comparator IN-	Pin 19 or 20, VCC, 1.2 V, 1.8 V, 2.4 V
Low-power comparator IN+	Any analog pin
Low-power comparator IN-	Pin 19 or 20, 1/16 to 15/16 VCC in steps of 1/16 VCC

Table 5: Possible uses of analog pin

2.8 u-blox connectivity software features

This section describes the available features when using the u-blox connectivity software. For additional information, see the u-blox Short Range AT Commands Manual [2].

2.8.1 u-blox Serial Port Service (SPS)

The serial port service feature enables serial port emulation over Bluetooth low energy.

2.8.2 System status signals

The **RED**, **GREEN** and **BLUE** pins are used to signal the system status according to Table 6. They are active low and are intended to be routed to an RGB LED.

Mode	Status	RGB LED Color	RED	GREEN	BLUE
Data\Extended Data mode (EDM)	IDLE	Green	HIGH	LOW	HIGH
Command mode	IDLE	Orange	LOW	LOW	HIGH
EDM/Data mode, Command mode	CONNECTING	Purple	LOW	HIGH	LOW
EDM/Data mode, Command mode	CONNECTED*	Blue	HIGH	HIGH	LOW

* = LED flashes on data activity

Table 6: System status indication

 The CONNECTING and CONNECTED statuses indicate u-blox SPS connections.

2.8.3 System control signals

The following input signals are used to control the system:

- **RESET_N** is used to reset the system. See section 2.4.5 for detailed information.
- If **SWITCH_2** is driven low during start up, the UART serial settings are restored to their default values.
- **SWITCH_2** can be used to open a Bluetooth LE connection with a peripheral device.
- If both **SWITCH_1** and **SWITCH_2** are driven low during start up, the system will enter the bootloader mode.
- If both **SWITCH_1** and **SWITCH_2** are driven low during start up and held low for 10 seconds, the system will exit the bootloader mode and restore all settings to their factory default.

2.8.4 UART signals

In addition to the normal **RXD**, **TXD**, **CTS**, and **RTS** signals, the u-blox connectivity software adds the **DSR** and **DTR** pins to the UART interface. Note that they are not used as originally intended, but to control the state of the ANNA module. For example, depending on the current configuration:

The **DSR** pin can be used to:

- Enter command mode
- Disconnect and/or toggle connectable status
- Enable/disable the rest of the UART interface
- Enter/wake up from sleep mode

The **DTR** pin can be used to indicate:

- The system mode
- If the SPS peers are connected
- If a Bluetooth LE bonded device is connected
- A Bluetooth LE GAP connection

 See the u-blox Short Range AT Commands Manual [2] for more information.

2.8.5 IO signals

When using the u-blox connectivity software, 11 module pins can be used for manual, digital read/write operations. These pins can be configured as outputs or inputs with or without pull-up/pull-down, using AT commands. For more information, see the u-blox Short Range AT Commands Manual [2].

 In this data sheet, these signals are defined as IO signals to distinguish from the GPIO signals described in section 2.6. The IO signals are used with u-blox connectivity software only and

controlled using AT commands; the GPIO signals, being a hardware functionality, can be used only by writing a custom software application.

2.9 Debug interfaces

2.9.1 SWD

The ANNA-B112 series modules provide an SWD interface for flashing and debugging. The SWD interface consists of two pins: **SWDCLK** and **SWDIO**.

2.9.2 Trace – Serial Wire Viewer

A serial trace option will also be available as an additional pin: **SWO**. The Serial Wire Output is used to:

- Support printf style debugging
- Trace OS and application events
- Emit diagnostic system information

A debugger that supports Serial Wire Viewer (SWV) is required. The trace function can be used only when developing a custom application.

3 Pin definition

3.1 Pin assignment open CPU

The pin-out described in Figure 3 below is an example pin-out that shows the module in an unconfigured state. Alternatively, if you use the u-blox connectivity software, refer to the pin-out in section 3.2.

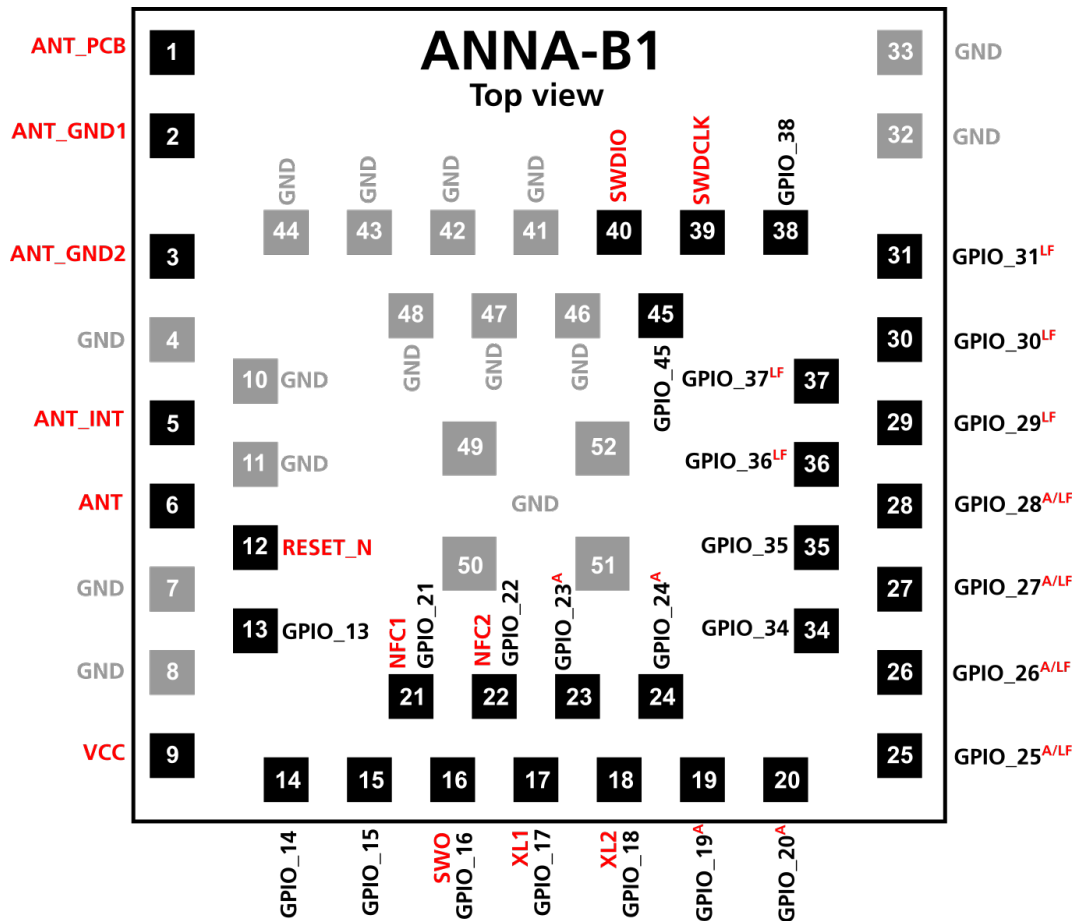

A = Analog function capable pin **LF** = Low Frequency, low drive I/O only

Signals that are highlighted in red are locked to a specific pin, the grey pins are GND pins.

Figure 3: ANNA-B112 pin assignment open CPU (top view)

All digital or analog functions described in this data sheet may be freely assigned to any GPIO pin. Analog functions are limited to analog capable pins.

GPIO pins 25-31 and 36-37 are connected to pins located close to the radio part of the RF chip. It is recommended to avoid using these pins for high speed digital interfaces or sinking/sourcing large currents through them. Doing so may affect RF performance.

Do not apply an NFC field to the NFC pins when they are configured as GPIOs as it can cause permanent damage to the module. When driving different logic levels on these pins in GPIO mode, a small current leakage will occur. Ensure that they are set to the same logic level before entering into any power saving modes. See section 4.2.7 for more information.

No.	Name	I/O	Description	nRF52 port	Remarks
1	ANT_PCB	-	Antenna pattern on carrier board if the module is mounted in a corner.		Should only be connected if the module is mounted in a corner. See section 2.2.1 for more info.
2	ANT_GND1	-	Antenna ground pattern if the module is mounted in the middle of a side.		Should only be connected if the module is mounted in the middle of a side. See section 2.2.1 for more info.
3	ANT_GND2	-	Antenna grounding if the module is mounted in the middle of a side.		Should only be connected if the module is mounted in the middle of a side. See section 2.2.1 for more info.
4	GND	-	Ground		
5	ANT_INT	-	Feeding to internal antenna of the module.		Connect to ANT pin if the internal antenna is used. See section 2.2.1 for more info.
6	ANT	-	Tx/Rx antenna interface.		50 Ω nominal characteristic impedance. Connect to ANT pin if the internal antenna is used. See section 2.2.1 for more info.
7-8	GND	-	Ground		
9	VCC	-	Module supply voltage input		1.7-3.6 V range.
10-11	GND	-	Ground		
12	RESET_N	I/O	System reset input	P0.21	Active low
13	GPIO_13	I/O	General purpose I/O	P0.14	
14	GPIO_14	I/O	General purpose I/O	P0.15	
15	GPIO_15	I/O	General purpose I/O	P0.16	
16	SWO/GPIO_16	I/O	Serial Wire debug trace data output	P0.18	May be used as a GPIO.
17	XL1	I/O	Connection for 32.768 kHz crystal (LFXO)	P0.00	If an external clock source is used instead of a crystal:
18	XL2	I/O	Connection for 32.768 kHz crystal (LFXO)	P0.01	Apply external low swing signal to XL1, ground XL2. Apply external full swing signal to XL1, leave XL2 grounded or unconnected. May be used as a GPIO.
19	GPIO_19	I/O	Analog function enabled GPIO	P0.03	Pin is analog capable
20	GPIO_20	I/O	Analog function enabled GPIO	P0.02	Pin is analog capable
21	NFC1/GPIO_21	I/O	NFC pin 1 (default)	P0.09	May be used as a GPIO
22	NFC2/GPIO_22	I/O	NFC pin 2 (default)	P0.10	May be used as a GPIO
23	GPIO_23	I/O	Analog function enabled GPIO	P0.05	Pin is analog capable
24	GPIO_24	I/O	Analog function enabled GPIO	P0.04	Pin is analog capable
25	GPIO_25	I/O	Analog function enabled GPIO	P0.31	Pin is analog capable, use as low drive, low frequency GPIO only
26	GPIO_26	I/O	Analog function enabled GPIO	P0.30	Pin is analog capable, use as low drive, low frequency GPIO only
27	GPIO_27	I/O	Analog function enabled GPIO	P0.29	Pin is analog capable, use as low drive, low frequency GPIO only
28	GPIO_28	I/O	Analog function enabled GPIO	P0.28	Pin is analog capable, use as low drive, low frequency GPIO only
29	GPIO_29	I/O	General purpose I/O	P0.27	Use as low drive, low frequency GPIO only

No.	Name	I/O	Description	nRF52 port	Remarks
30	GPIO_30	I/O	General purpose I/O	P0.25	Use as low drive, low frequency GPIO only
31	GPIO_31	I/O	General purpose I/O	P0.26	Use as low drive, low frequency GPIO only
32-33	GND	-	Ground		
34	GPIO_34	I/O	General purpose I/O	P0.11	
35	GPIO_35	I/O	General purpose I/O	P0.19	
36	GPIO_36	I/O	General purpose I/O	P0.22	Use as low drive, low frequency GPIO only
37	GPIO_37	I/O	General purpose I/O	P0.23	Use as low drive, low frequency GPIO only
38	GPIO_38	I/O	General purpose I/O	P0.24	
39	SWDCLK	I	Serial Wire Debug port clock signal		
40	SWDIO	I/O	Serial Wire Debug port data signal		
41-44	GND	-	Ground		
45	GPIO_45	I/O	General purpose I/O	P0.20	
46-48	GND	-	Ground		
49-52	EGP	-	Exposed Ground Pins		The exposed pins in the center of the module should be connected to GND

Table 7: ANNA-B112 pin-out open CPU

3.2 Pin assignment in the u-blox connectivity software

The pin-out as shown in Figure 4 describes the pin configuration used in the u-blox connectivity software.

Figure 4 and Table 8 reflect the latest u-blox connectivity software version only.

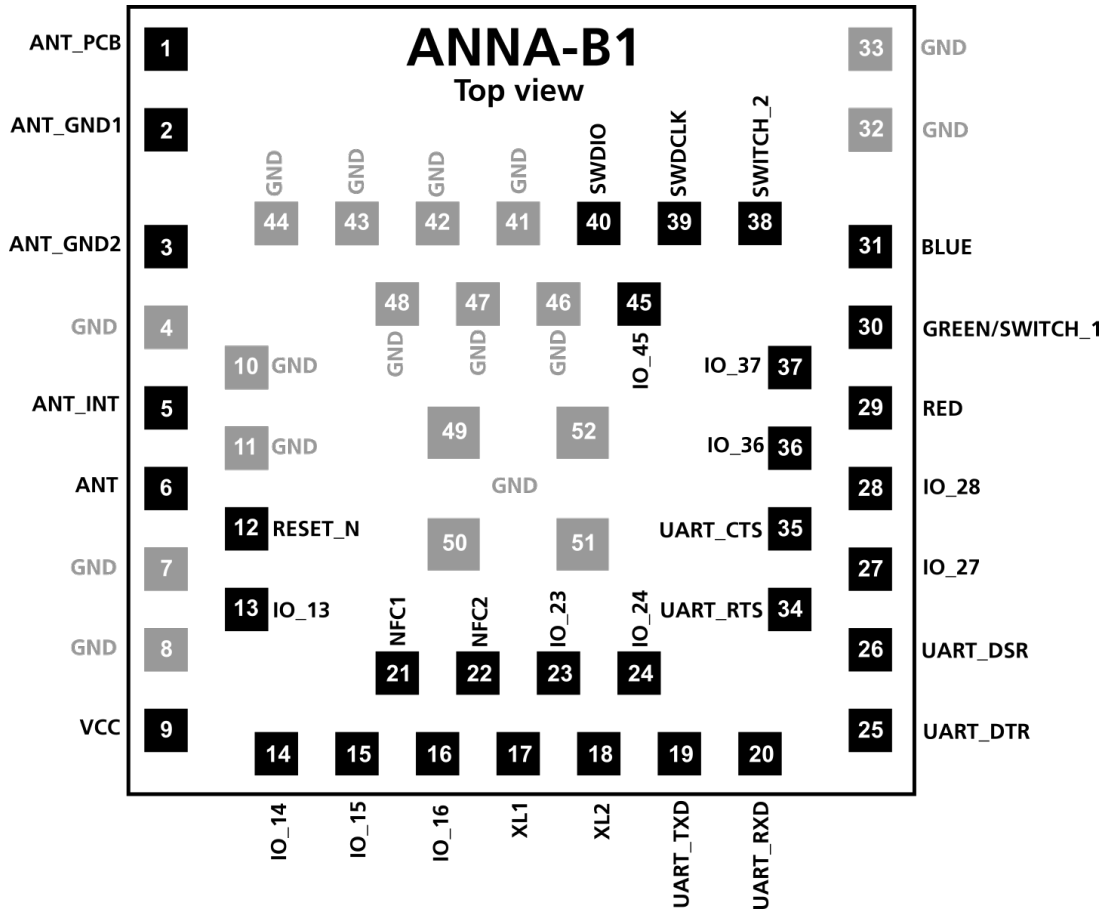

Figure 4: ANNA-B112 pin assignment (top view) while using the u-blox connectivity software. The grey pins are GND pins.

It is required to follow this pin layout when using the u-blox connectivity software. No additional interfaces can be added.

No.	Name	I/O	Description	Remarks
1	ANT_PCB	-	Antenna pattern on carrier board if the module is mounted in a corner.	Should only be connected if the module is mounted in a corner. See section 2.2.1 for more info.
2	ANT_GND1	-	Antenna ground pattern if the module is mounted in the middle of a side.	Should only be connected if the module is mounted in the middle of a side. See section 2.2.1 for more info.
3	ANT_GND2	-	Antenna grounding if the module is mounted in the middle of a side.	Should only be connected if the module is mounted in the middle of a side. See section 2.2.1 for more info.
4	GND	-	Ground	
5	ANT_INT	-	Feeding to internal antenna of the module.	Connect to ANT pin if the internal antenna is used. See section 2.2.1 for more info.
6	ANT	-	Tx/Rx antenna interface.	50 Ω nominal characteristic impedance. Connect to ANT pin if the internal antenna is used. See section 2.2.1 for more info.
7-8	GND	-	Ground	
9	VCC	-	Module supply voltage input	1.7-3.6 V range.
10-11	GND	-	Ground	
12	RESET_N	I	System reset input	Active low
13	IO_13	I/O	u-blox connectivity software IO pin	Can be used for manual digital I/O
14	IO_14	I/O	u-blox connectivity software IO pin	Can be used for manual digital I/O
15	IO_15	I/O	u-blox connectivity software IO pin	Can be used for manual digital I/O
16	IO_16	I/O	u-blox connectivity software IO pin	Can be used for manual digital I/O
17	XL1	-	Connection for 32.768 kHz crystal (LFXO)	If an external clock source is used instead of a crystal: Apply external low swing signal to XL1, ground XL2. Apply external full swing signal to XL1, leave XL2 grounded or unconnected.
18	XL2	-	Connection for 32.768 kHz crystal (LFXO)	
19	UART_TXD	O	UART data output	
20	UART_RXD	I	UART data input	
21	NFC1	I/O	NFC pin 1	
22	NFC2	I/O	NFC pin 2	
23	IO_23	I/O	u-blox connectivity software IO pin	Can be used for manual digital I/O
24	IO_24	I/O	u-blox connectivity software IO pin	Can be used for manual digital I/O
25	UART_DTR	O	UART data terminal ready signal	Used to indicate system status
26	UART_DSR	I	UART data set ready signal	Used to change system modes
27	IO_27	I/O	u-blox connectivity software IO pin	Can be used for manual digital I/O
28	IO_28	I/O	u-blox connectivity software IO pin	Can be used for manual digital I/O
29	RED	O	RED system status signal	Active low, should be routed to an RGB LED
30	GREEN/SWITCH_1	I/O	This signal is multiplexed: GREEN: System status signal. SWITCH_1: Multiple functions	Active low. GREEN: Should be routed to an RGB LED. SWITCH_1: See section 2.8.3 for more information.
31	BLUE	O	BLUE system status signal	Active low, should be routed to an RGB LED
32-33	GND	-	Ground	

No.	Name	I/O	Description	Remarks
34	UART_RTS	O	UART request to send control signal	Used only when hardware flow control is enabled
35	UART_CTS	I	UART clear to send control signal	Used only when hardware flow control is enabled
36	IO_36	I/O	u-blox connectivity software IO pin	Can be used for manual digital I/O
37	IO_37	I/O	u-blox connectivity software IO pin	Can be used for manual digital I/O
38	SWITCH_2	I	Multiple functions	Active low, see section 2.8.3 for more information.
39	SWDCLK	I	Serial Wire Debug port clock signal	
40	SWDIO	I/O	Serial Wire Debug port data signal	
41-44	GND	-	Ground	
45	IO_45	I/O	u-blox connectivity software IO pin	Can be used for manual digital I/O
46-48	GND	-	Ground	
49-52	EGP	-	Exposed Ground Pins	The exposed pins in the center of the module should be connected to GND

Table 8: ANNA-B112 and u-blox connectivity software pin-out

4 Electrical specifications

Stressing the device above one or more of the ratings listed in the Absolute maximum rating section may cause permanent damage. These are stress ratings only. Operating the module at these or at any conditions other than those specified in the Operating conditions section of this document should be avoided. Exposure to absolute maximum rating conditions for extended periods may affect device reliability.

Operating condition ranges define those limits within which the functionality of the device is guaranteed. Where application information is given, it is advisory only and does not form part of the specification.

4.1 Absolute maximum ratings

Symbol	Description	Condition	Min	Max	Unit
VCC	Module supply voltage	Input DC voltage at VCC pin	-0.3	3.9	V
P_ANT	Maximum power at receiver	Input RF power at antenna pin		+10	dBm

Table 9: Absolute maximum ratings

The product is not protected against overvoltage or reversed voltages. If necessary, voltage spikes exceeding the power supply voltage specification, given in table above, must be limited to values within the specified boundaries by using appropriate protection devices.

4.1.1 Maximum ESD ratings

Parameter	Min	Typical	Max	Unit	Remarks
ESD sensitivity for all pins except ANT pin			4	kV	Human body model according to JEDEC JS001
			750	V	Charged device model according to JESD22-C101
ESD indirect contact discharge			±8	kV	According to EN 301 489-1

Table 10: Maximum ESD ratings

ANNA-B112 modules are Electrostatic Sensitive Devices and require special precautions while handling. See section 8.6 for ESD handling instructions.

4.2 Operating conditions

Unless otherwise specified, all operating condition specifications are at an ambient temperature of 25°C and a supply voltage of 3.3 V.

Operation beyond the specified operating conditions is not recommended and extended exposure beyond them may affect device reliability.

4.2.1 Operating temperature range

Parameter	Min	Max	Unit
Storage temperature	-40	+85	°C
Operating temperature	-40	+85	°C

Table 11: Temperature range

4.2.2 Supply/Power pins

Symbol	Parameter	Min	Typ	Max	Unit
VCC	Input supply voltage	1.7	3.0	3.6	V
t_RVCC	Supply voltage rise time			60	ms
VCC_ripple	VCC input noise peak to peak, 10 - 100 KHz			100	mV
	VCC input noise peak to peak, 100 KHz - 1 MHz			50	mV
	VCC input noise peak to peak, 1 - 3 MHz			25	mV

Table 12: Input characteristics of voltage supply pins

4.2.3 Current consumption

Table 13 shows the typical current consumption of a ANNA-B112 module, independent of the software used.

Mode	Condition	Typical	Peak
Sleep	No clocks running, no RAM data retention	300 nA	
Sleep	No clocks running, 64 kB RAM data retention	620 nA	
Standby	RTC and 64 kB RAM data retention. System running on 32.768 kHz clock from crystal.	2.2 μ A	
Active	CPU running benchmarking tests @ 64 MHz clock speed, all interfaces idle	3.7 mA	
Active	Radio RX only	5.4 mA	
Active	Radio TX only, +0dBm output power	5.3 mA	

Table 13: Module VCC current consumption

Table 14 shows the current consumption during some typical use cases when using the u-blox connectivity software and an external 32.768 kHz crystal:

Mode	Condition	3.3 V VCC		1.8 V VCC	
		Average	Peak	Average	Peak
Active	Advertising 1s periods with +4 dBm output power and 31 bytes payload, CPU and UART interface is running	1.8 mA	12 mA	2.5 mA	20 mA
Standby	Advertising 1s periods with +4 dBm output power and 31 bytes payload	26 μ A	9.3 mA	34 μ A	16 mA
Standby	One advertisement event (4.7 ms), +4 dBm output power and 31 bytes payload	3.4 mA	9.3 mA	5.3 mA	16 mA
Active	Connected as peripheral, connection events 30 ms periods, +4 dBm output power and 0 bytes payload, CPU and UART interface is running	1.8 mA	12 mA	2.6 mA	21 mA
Standby	Connected as peripheral, connection events 30 ms periods, +4 dBm output power and 0 bytes payload	140 μ A	9.2 mA	190 μ A	16 mA
Sleep	UART DSR pin is used to enter sleep mode. No RAM retention	300 nA	2.6 mA	300 nA	2.6 mA

Table 14: Current consumption during typical use cases

4.2.4 RF performance

Parameter	Test condition	Min	Typ	Max	Unit
Receiver input sensitivity	Conducted at 25 °C		-91		dBm
Output power	Conducted at 25 °C		+4		dBm

Table 15: RF performance

4.2.5 ANNA-B112 radiation patterns

The antenna radiation test set-up utilizes the reference design based on evaluation board with ANNA-B112 situated in the corner of the board, EVK-ANNA-B112C. See the ANNA-B112 System Integration Manual [1] for more information.

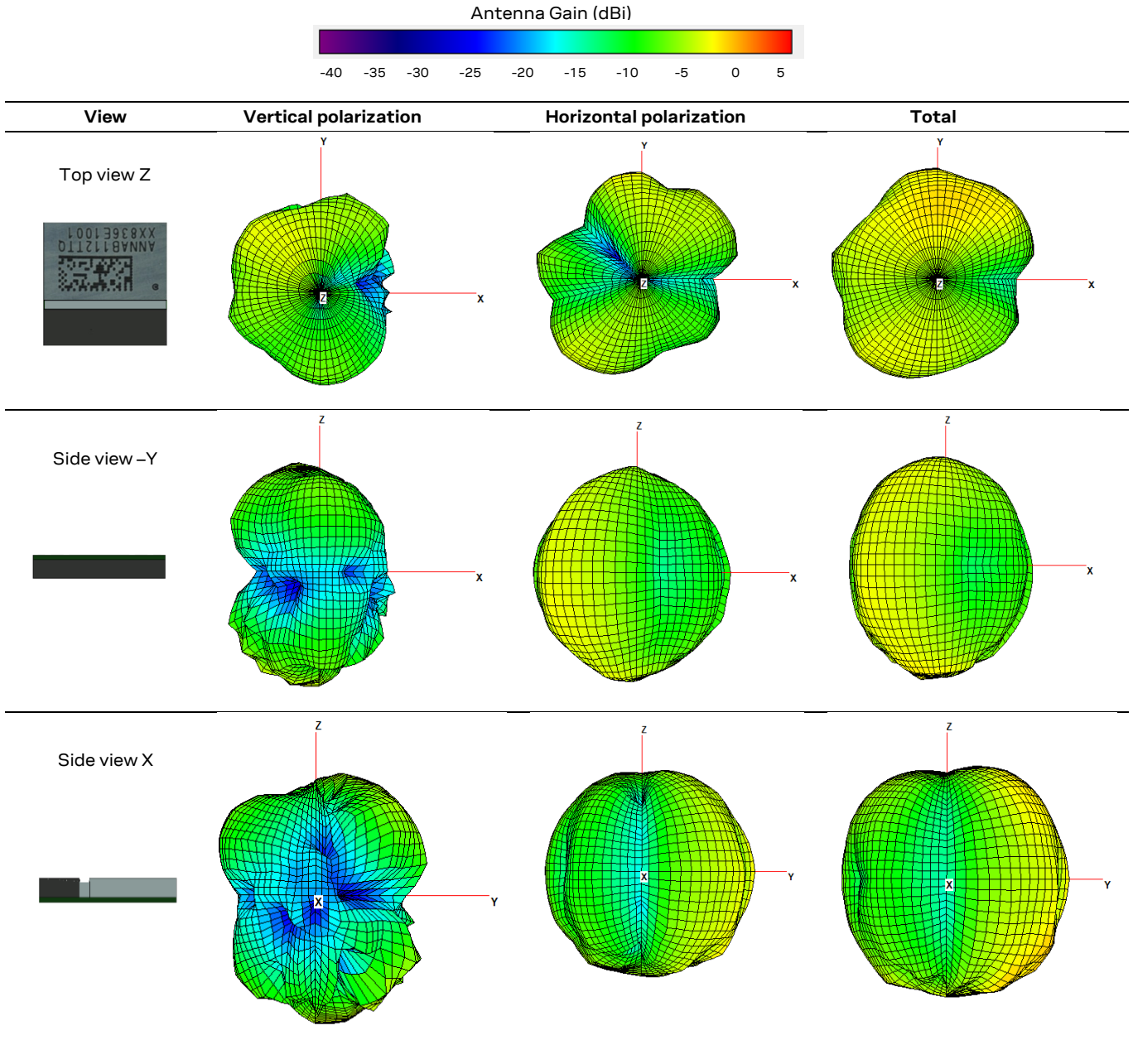

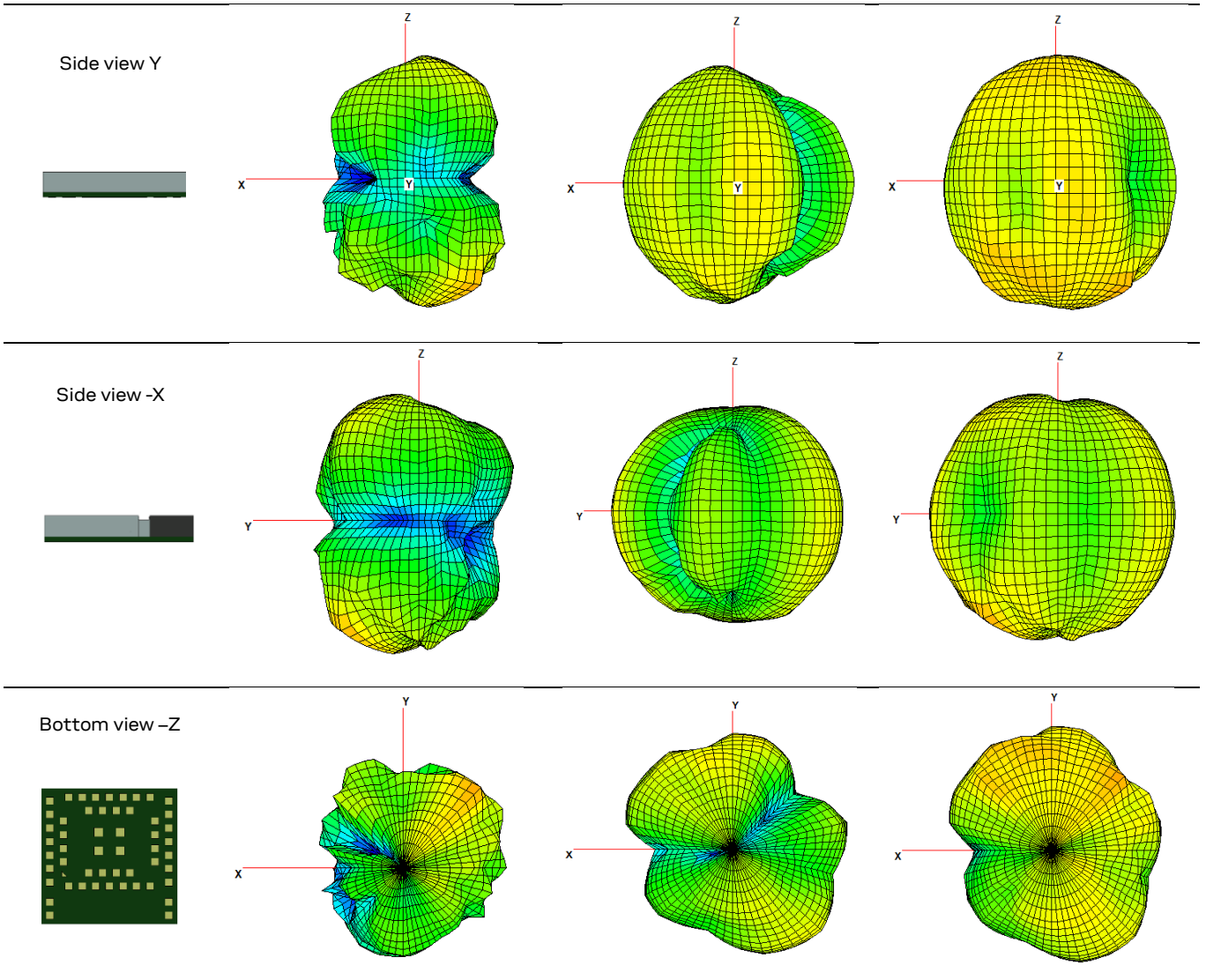

Table 16: Antenna radiation patterns

4.2.6 RESET_N pin

Pin name	Parameter	Min	Typ	Max	Unit	Remarks
RESET_N	Low-level input	0		0.3*VCC	V	
	Internal pull-up resistance		13		kΩ	
	RESET duration			55	ms	Time taken to release a pin reset.

Table 17: RESET_N pin characteristics

4.2.7 Digital pins

Pin name	Parameter	Min	Typ	Max	Unit	Remarks	
Any digital pin	Input characteristic: Low-level input	0		0.3*VCC	V		
	Input characteristic: high-level input	0.7*VCC		VCC	V		
	Output characteristic: Low-level output		0		0.4	V	Normal drive strength
			0		0.4	V	High drive strength
	Output characteristic: High-level output		VCC-0.4		VCC	V	Normal drive strength
			VCC-0.4		VCC	V	High drive strength
	Pull-up resistance	11	13	16	kΩ		
Pull-down resistance	11	13	16	kΩ			
Any digital pin except IO_28 and IO_29	Pin capacitance		3		pF		
IO_28 and IO_29	Leakage current		2	10	μA	When driven to different logic levels	
	Pin capacitance		4		pF		

Table 18: Digital pin characteristics

5 Mechanical specifications

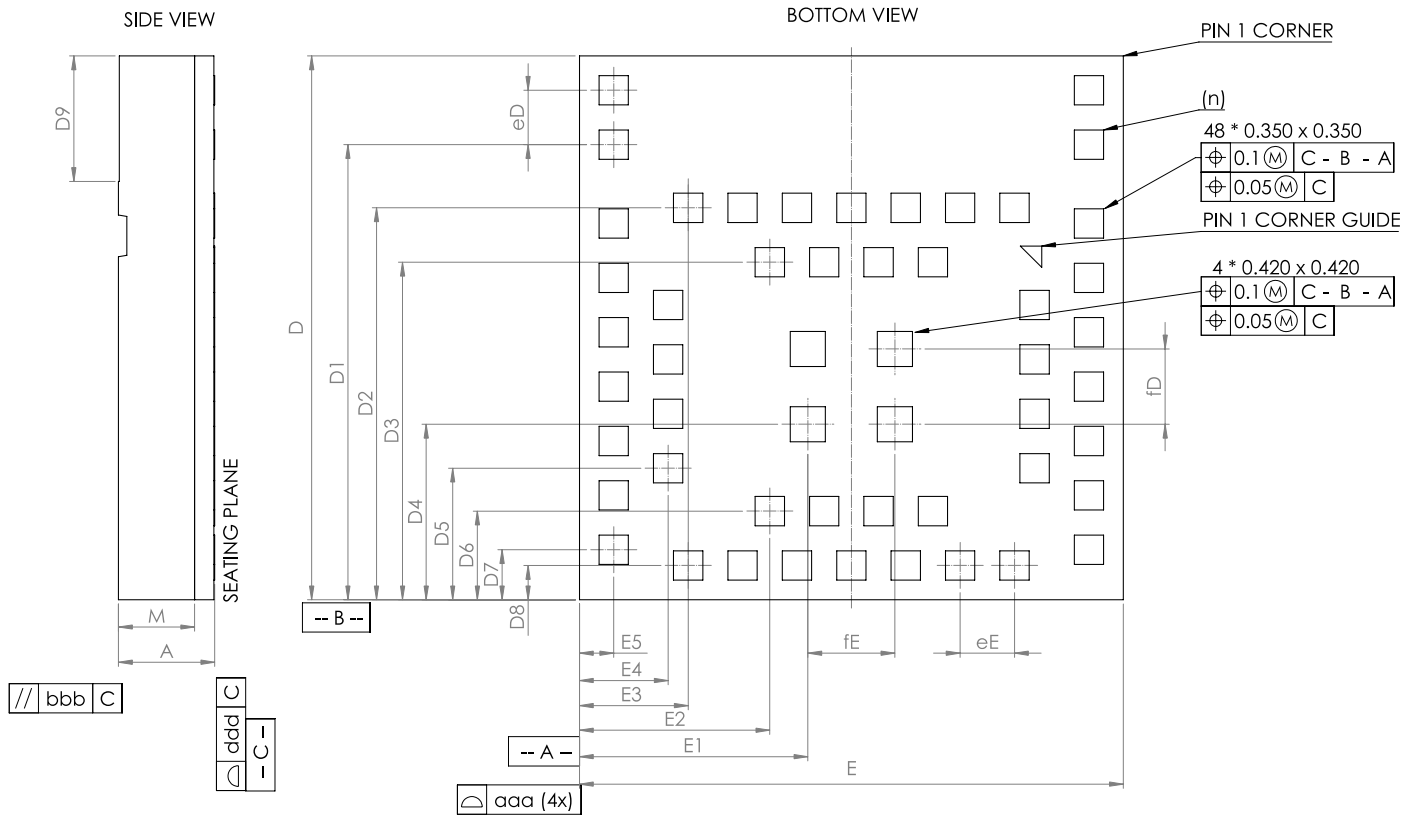

Description	Symbol	Dimensions (mm)	Tolerance (mm)
Package		PIM	
Width	E	6.500	+/- 0.100
Length	D	6.500	+/- 0.100
Outer Pitch	eE	0.650	
Outer Pitch	fE	0.650	
Inner Pitch	gE	1.040	
Inner Pitch	hE	0.900	
Total thickness	A	1.150	+/- 0.100
Mold thickness	M	0.210	
	E1	2.730	
	E2	2.275	
	E3	1.300	
	E4	1.060	
	E5	0.410	
	D1	5.440	
	D2	4.685	
	D3	4.035	
	D4	2.098	
	D5	1.573	
	D6	1.060	
	D7	0.598	
	D8	0.410	
Antenna Area	D9	1.500	
Lead Count	n	52	
Package Edge Tolerance	aaa	0.100	
Mold Flatness	bbb	0.100	
Coplanarity	ddd	0.100	

6 Qualification and approvals

6.1 Country approvals

The ANNA-B112 module series will be certified for use in the following countries/regions:

- Europe (ETSI RED)
- US (FCC/CFR 47 part 15 unlicensed modular transmitter approval)
- Canada (IC/ISED RSS)
- Japan (MIC)
- Taiwan (NCC)
- South Korea (KCC)²
- Australia / New Zealand (ACMA)²
- South Africa (ICASA)²
- Brazil (Anatel)²

See the following sections for additional information.

6.2 European Union regulatory compliance

Information about regulatory compliance of the European Union for ANNA-B112 modules is available in the ANNA-B112 Declaration of Conformity [4].

6.2.1 Radio Equipment Directive (RED) 2014/53/EU

The ANNA-B112 modules comply with the essential requirements and other relevant provisions of Radio Equipment Directive (RED) 2014/53/EU.

6.2.2 Compliance with the RoHS directive

The ANNA-B112 modules comply with the "Directive 2015/863/EU" of the European Parliament and the Council on the Restriction of Use of certain Hazardous Substances in Electrical and Electronic Equipment" (RoHS).

6.3 FCC and IC Compliance

This device complies with Part 15 of the FCC Rules and with Industry Canada license-exempt RSS standard(s).

Caution

-  Any changes or modification NOT explicitly APPROVED by u-blox AG may cause the module to cease to comply with FCC rules part 15 thus void the user's authority to operate the equipment.

² Approval is pending

6.3.1 FCC compliance

The ANNA-B112 modules are for OEM integrations only. The end product must be professionally installed in such manner that only the authorized antennas can be used.

For ANNA-B112 three variants of antenna reference designs are available and one of these must be followed to comply with the ANNA-B112 FCC/IC modular approval (see ANNA-B112 System Integration Manual). Two of the reference designs show different variants of implementing internal antenna and one describes how to implement external antenna connector (U.FL. connector).

6.3.1.1 FCC statement

This device complies with Part 15 of the FCC Rules. Operation is subject to the following two conditions:

1. This device may not cause harmful interference, and
2. This device must accept any interference received, including interference that may cause undesired operation.

This equipment has been tested and found to comply with the limits for a Class B digital device, pursuant to Part 15 of the FCC Rules. These limits are designed to provide reasonable protection against harmful interference in a residential installation. This equipment generates, uses and can radiate radio frequency energy and, if not installed and used in accordance with the instructions, may cause harmful interference to radio communications. However, there is no guarantee that the interference will not occur in a particular installation. If this equipment does cause harmful interference to radio or television reception, which can be determined by turning the equipment off and on, the user is encouraged to try to correct the interference by one or more of the following measures:

- Reorient or relocate the receiving antenna
- Increase the separation between the equipment and receiver
- Connect the equipment into an outlet on a circuit different from that to which the receiver is connected.
- Consult the dealer or an experienced radio/TV technician for help.

6.3.2 RF-exposure statement

6.3.2.1 IC Compliance

This equipment complies with the requirements of IC RSS-102 issue 5 radiation exposure limits set forth for an uncontrolled environment.

Having a separation distance of minimum 10 mm between the user and/or bystander and the antenna and /or radiating element ensures that the output power (e.i.r.p.) of ANNA-B112 is below the SAR evaluation Exemption limits defined in RSS-102 issue 5.

6.3.2.2 FCC Compliance

This device complies with the FCC radiation exposure limits set forth for an uncontrolled environment.

Having a separation distance of minimum 5 mm between the user and/or bystander and the antenna and /or radiating element ensures that max output power of ANNA-B112 is below the SAR test exclusion limits presented in KDB 447498 D01v06.

6.3.3 End product user manual instructions

6.3.3.1 IC Compliance

-  User manuals for license-exempt radio apparatus shall contain the following text, or an equivalent notice that shall be displayed in a conspicuous location, either in the user manual or on the device, or both:

"This device complies with Industry Canada's license-exempt RSSs. Operation is subject to the following two conditions:

- (1) This device may not cause interference; and*
- (2) This device must accept any interference, including interference that may cause undesired operation of the device. "*

Under Industry Canada regulations, this radio transmitter can only operate using an antenna of a type and maximum (or lesser) gain approved for the transmitter by Industry Canada. To reduce potential radio interference to other users, the antenna type and its gain should be chosen in such a way that the equivalent isotropically radiated power (e.i.r.p.) is not more than that is necessary for successful communication.

-  Le manuel d'utilisation des appareils radio exempts de licence doit contenir l'énoncé qui suit, ou l'équivalent, à un endroit bien en vue dans le manuel d'utilisation ou sur l'appareil, ou encore aux deux endroits:

"Le présent appareil est conforme aux CNR d'Industrie Canada applicables aux appareils radio exempts de licence. L'exploitation est autorisée aux deux conditions suivantes:

- (1) l'appareil ne doit pas produire de brouillage;*
- (2) l'utilisateur de l'appareil doit accepter tout brouillage radioélectrique subi, même si le brouillage est susceptible d'en compromettre le fonctionnement. "*

Conformément aux réglementations d'Industry Canada, cet émetteur radio ne peut fonctionner qu'à l'aide d'une antenne dont le type et le gain maximal (ou minimal) ont été approuvés pour cet émetteur par Industry Canada. Pour réduire le risque d'interférences avec d'autres utilisateurs, il faut choisir le type d'antenne et son gain de telle sorte que la puissance isotrope rayonnée équivalente (p.i.r.e) ne soit pas supérieure à celle requise pour obtenir une communication satisfaisante.

6.3.4 End product labeling requirements

6.3.4.1 IC Compliance

The host product shall be properly labelled to identify the modules within the host product. The Innovation, Science and Economic Development Canada certification label of a module shall be clearly visible at all times when installed in the host product; otherwise, the host product must be labelled to display the Innovation, Science and Economic Development Canada certification number for the module, preceded by the word "Contains" or similar wording expressing the same meaning, as shown in Figure 5.

Le produit hôte devra être correctement étiqueté, de façon à permettre l'identification des modules qui s'y trouvent.

L'étiquette d'homologation d'un module d'Innovation, Sciences et Développement économique Canada devra être posée sur le produit hôte à un endroit bien en vue, en tout temps. En l'absence d'étiquette, le produit hôte doit porter une étiquette sur laquelle figure le numéro d'homologation du module d'Innovation, Sciences et Développement économique Canada, précédé du mot « contient », ou d'une formulation similaire allant dans le même sens et qui va comme suit:

This device contains
FCC ID: XPYANNAB1
IC: 8595A-ANNAB1

Figure 5: Example of an end product label

6.3.4.2 FCC Compliance

For an end product that uses the ANNA-B112 module, there must be a label containing, at least, the information shown in Figure 5.

The label must be affixed on an exterior surface of the end product such that it will be visible upon inspection in compliance with the modular approval guidelines developed by the FCC.



In accordance with 47 CFR § 15.19, the end product shall bear the following statement in a conspicuous location on the device:

"This device complies with Part 15 of the FCC Rules. Operation is subject to the following two conditions;

- (1) this device may not cause harmful interference, and*
- (2) this device must accept any interference received, including interference that may cause undesired operation."*

When the device is so small or for such use that it is not practicable to place the statement above on it, the information shall be placed in a prominent location in the instruction manual or pamphlet supplied to the user or, alternatively, shall be placed on the container in which the device is marketed.

In case, where the final product will be installed in locations where the end-user is not able to see the FCC ID and/or this statement, the FCC ID and the statement shall also be included in the end product manual.

6.3.5 FCC and IC IDs

Model	FCC ID	ISED certification number
ANNA-B112	XPYANNAB1	8595A-ANNAB1

Table 19: FCC and ISED certification number for the ANNA-B112 module

6.3.6 End product compliance

6.3.6.1 General requirements

- Any changes to hardware, hosts or co-location configuration may require new radiated emission and SAR evaluation and/or testing.
- Only authorized antenna(s) may be used.
- Any notification to the end user about how to install or remove the integrated radio module is NOT allowed.

- The modular transmitter approval of ANNA-B112 does not exempt the end product from being evaluated against applicable regulatory demands. The evaluation of the end product shall be performed with the ANNA-B112 module installed and operating in a way that reflects the intended end product use case. The upper frequency measurement range of the end product evaluation is the 5th harmonic of 2.4 GHz as declared in 47 CFR Part 15.33 (b)(1).
- The following requirements apply to all products that integrate a radio module:
 - Subpart B - UNINTENTIONAL RADIATORS
To verify that the composite device of host and module complies with the requirements of FCC part 15B the integrator shall perform sufficient measurements using ANSI 63.4-2014.
 - Subpart C - INTENTIONAL RADIATORS
It is required that the integrator carry out sufficient verification measurements using ANSI 63.10-2013 to validate that the fundamental and out of band emissions of the transmitter part of the composite device complies with the requirements of FCC part 15C.
- When the items listed above are fulfilled the host manufacturer can use the authorization procedures presented in Table 1 of 47 CFR Part 15.101.

6.3.6.2 Co-location (simultaneous transmission)

If the module is to be co-located with another transmitter, additional measurements for simultaneous transmission are required.

6.4 Japan radio equipment compliance

6.4.1 Compliance statement

The ANNA-B112 module complies with the Japanese Technical Regulation Conformity Certification of Specified Radio Equipment (ordinance of MPT N°. 37, 1981), Article 2, Paragraph 1:

- Item 19 "2.4 GHz band wide band low power data communication system".

6.4.2 End product labelling requirement

When a product integrating a ANNA-B112 series module is placed on the Japanese market the product must be affixed with a label with the "Giteki" marking as shown in Figure 6. The marking must be visible for inspection.



Figure 6: Giteki mark,  and the ANNA-B112 MIC certification number

 The required minimum size of the Giteki mark is Ø3.0 mm.

6.4.3 End product user manual requirement

As the MIC ID is not included on the ANNA-B112 marking, the end product manufacturer must include a copy of the ANNA-B112 Japan Radio Certificate to the end product technical documentation.

6.5 NCC Taiwan compliance

6.5.1 Taiwan NCC Warning Statement

- 經型式認證合格之低功率射頻電機，非經許可，公司、商號或使用者均不得擅自變更頻率、加大功率或變更原設計之特性及功能。
- 低功率射頻電機之使用不得影響飛航安全及干擾合法通信；經發現有干擾現象時，應立即停用，並改善至無干擾時方得繼續使用。前項合法通信，指依電信法規定作業之無線電通信。低功率射頻電機須忍受合法通信或工業、科學及醫療用電波輻射性電機設備之干擾。

Statement translation:

- Without permission granted by the NCC, any company, enterprise, or user is not allowed to change frequency, enhance transmitting power or alter original characteristic as well as performance to an approved low power radio-frequency devices.
- The low power radio-frequency devices shall not influence aircraft security and interfere legal communications; If found, the user shall cease operating immediately until no interference is achieved. The said legal communications means radio communications is operated in compliance with the Telecommunications Act. The low power radio-frequency devices must be susceptible with the interference from legal communications or ISM radio wave radiated devices.

6.5.2 ANNA-B112 labeling requirements for end product

When a product integrated with an ANNA-B112 module is placed on the Taiwan market, the product must be affixed with a label marking as shown below. The label can use wording such as the following:

Contains Transmitter Module

□ □ □ □ □ □ □ □ :  CCAI18LP2200T2

or any similar wording that expresses the same meaning may be used. The marking must be visible for inspection.

6.6 Safety compliance

In order to fulfill the safety standard EN 60950-1, the ANNA-B112 modules must be supplied with a Class-2 Limited Power Source.

6.7 Bluetooth qualification information



- ® The ANNA-B112 modules have been qualified according to the Bluetooth version 5.0 specifications. For an end product with ANNA-B112 integrated, no further qualification is required. If the end product is to be Bluetooth listed, the QD ID listed in Table 20 shall be included in the end product listing. Table 20 contains the QD ID to refer to.

Bluetooth version	Bluetooth product type	QD ID	Listing Date	Nordic SoftDevice S132 version	u-Blox connectivity software version
5.0	End Product	119389	2018-10-05	5.0.0 or later	1.0.0 or later

Table 20: ANNA-B112 Bluetooth QD IDs

7 Antennas

This chapter gives an overview of the different external antennas that can be used together with the module.

- Note that not all antennas are approved for use in all markets/regions.
- This radio transmitter IC: 8595A-ANNAB1 has been approved by Industry Canada to operate with the antenna types listed below with the maximum permissible gain and required antenna impedance for each antenna type indicated. Antenna types not included in this list, having a gain greater than the maximum gain indicated for that type, are strictly prohibited for use with this device.
- Cet émetteur radio IC: 8595A-ANNAB1 été approuvé par Industry Canada pour fonctionner avec les types d'antenne énumérés ci-dessous avec le gain maximum autorisé et l'impédance nécessaire pour chaque type d'antenne indiqué. Les types d'antenne ne figurant pas dans cette liste et ayant un gain supérieur au gain maximum indiqué pour ce type-là sont strictement interdits d'utilisation avec cet appareil.

For each antenna, the "Approvals" field defines in which test reports the antenna is included. Definitions of the «Approvals» field are:

- FCC - The antenna is included in the FCC test reports and thus approved for use in countries that accept the FCC radio approvals, primarily US.
- IC - The antenna is included in the IC (Industrie Canada) test reports and thus approved for use in countries that accept the IC radio approvals, primarily Canada.
- RED - The antenna is included in the ETSI test reports and thus approved for use in countries that accept the Radio Equipment Directive, primarily the European countries.
- MIC - The antenna is included in the Japanese government affiliated MIC test reports and thus approved for use in the Japanese market.
- NCC - The antenna is included in the Taiwan NCC test reports and thus approved for use in Taiwan.
- KCC - The antenna is included in the Korea KCC test reports and thus approved for use in Korea.
- ANATEL – The antenna is included in the Brazil Anatel test reports and thus approved for use in Brazil.
- ICASA – The antenna is included in the South Africa ICASA test reports and thus approved for use in South Africa.

7.1 Approved antennas

ANNA-B112 internal antenna	
Gain	+0.7 dBi
Comment	Internal antenna on ANNA-B112, see section 2.2.1 and ANNA-B112 System Integration Manual [1] for reference design for more info. Should not be mounted inside a metal enclosure.
Approval	FCC, IC, RED, MIC and NCC



FXP75.07.0045B

Manufacturer	Taoglas
Gain	+2.5 dBi
Impedance	50 Ω
Size	5.9 x 4.1 x 0.24 mm
Type	Patch, Flexfilm
Connector	U.FL.
Cable length	45 mm
Comment	Should be attached to a plastic enclosure or part for best performance. For more info see antenna data sheet. Should not be mounted inside a metal enclosure. To be mounted on a U.FL connector.
Approval	FCC, IC, RED, MIC and NCC

PC17.07.0070A

Manufacturer	Taoglas
Gain	+1.0 dBi
Impedance	50 Ω
Size	24.0 x 11.0 x 0.8 mm
Type	Patch, PCB
Connector	U.FL.
Cable length	70 mm
Comment	Should be attached to a plastic enclosure or part for best performance. For more info see antenna data sheet. Should not be mounted inside a metal enclosure. To be mounted on a U.FL connector.
Approval	FCC, IC, RED, MIC and NCC



FXP74.07.0100A

Manufacturer	Taoglas
Gain	+4.0 dBi
Impedance	50 Ω
Size	47.0 x 7.0 x 0.1 mm
Type	Patch, Flexfilm
Connector	U.FL.
Cable length	100 mm
Comment	Should be attached to a plastic enclosure or part for best performance. For more info see antenna data sheet. Should not be mounted inside a metal enclosure. To be mounted on a U.FL connector.
Approval	RED and MIC

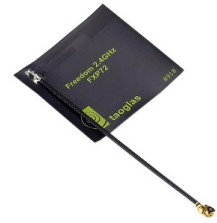

FXP72.07.0053A

Manufacturer	Taoglas
Gain	+5.0 dBi
Impedance	50 Ω
Size	31.0 x 31.0 x 0.1 mm
Type	Patch, Flexfilm
Connector	U.FL.
Cable length	53 mm
Comment	Should be attached to a plastic enclosure or part for best performance. For more info see antenna data sheet. Should not be mounted inside a metal enclosure. To be mounted on a U.FL connector.
Approval	RED and MIC



8 Product handling

8.1 Packaging

The ANNA-B112 modules are delivered as hermetically sealed, reeled tapes to enable efficient production, production lot set-up and tear-down.

8.2 Reels

Detailed information about the reel types for the ANNA-B112 modules are provided in Table 21.

Model	Reel Type	Reel Part Number	Qty
ANNA-B112	7"	MYR-131-BB	500 pcs/reel

Table 21: Reel type for ANNA-B112

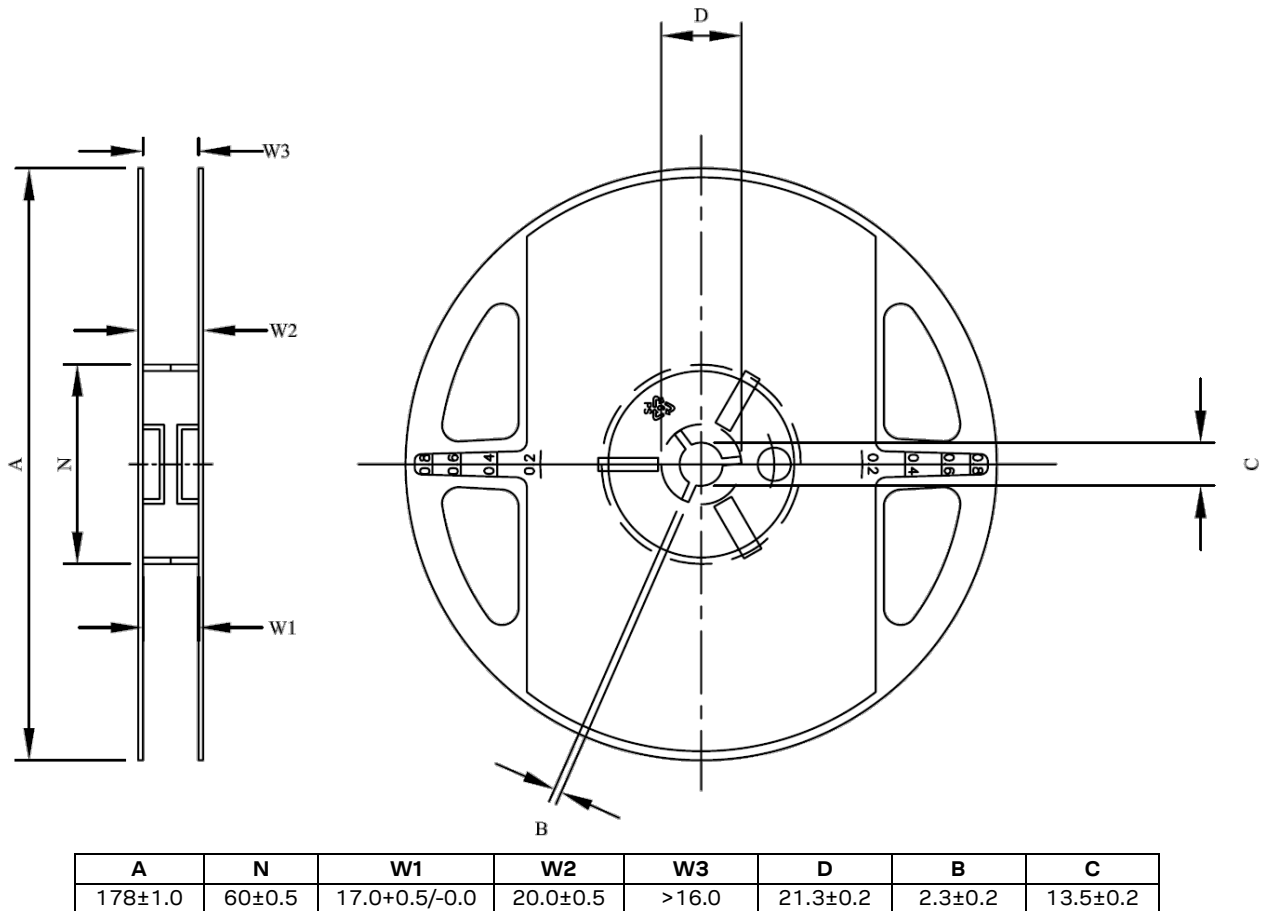

Figure 7: 7" reel for ANNA-B112 modules

8.3 Tapes

Figure 8 shows the position and orientation of the ANNA-B112 modules as they are delivered on tape. The dimensions of the tapes are specified in Figure 9.

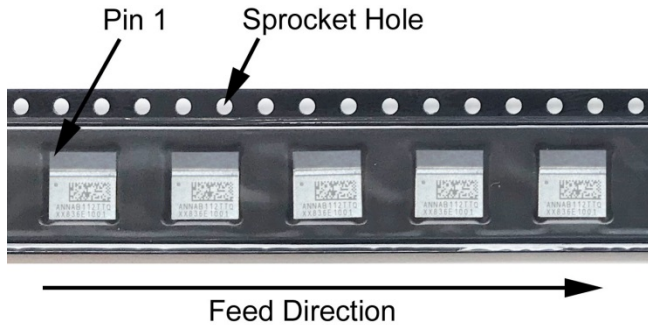
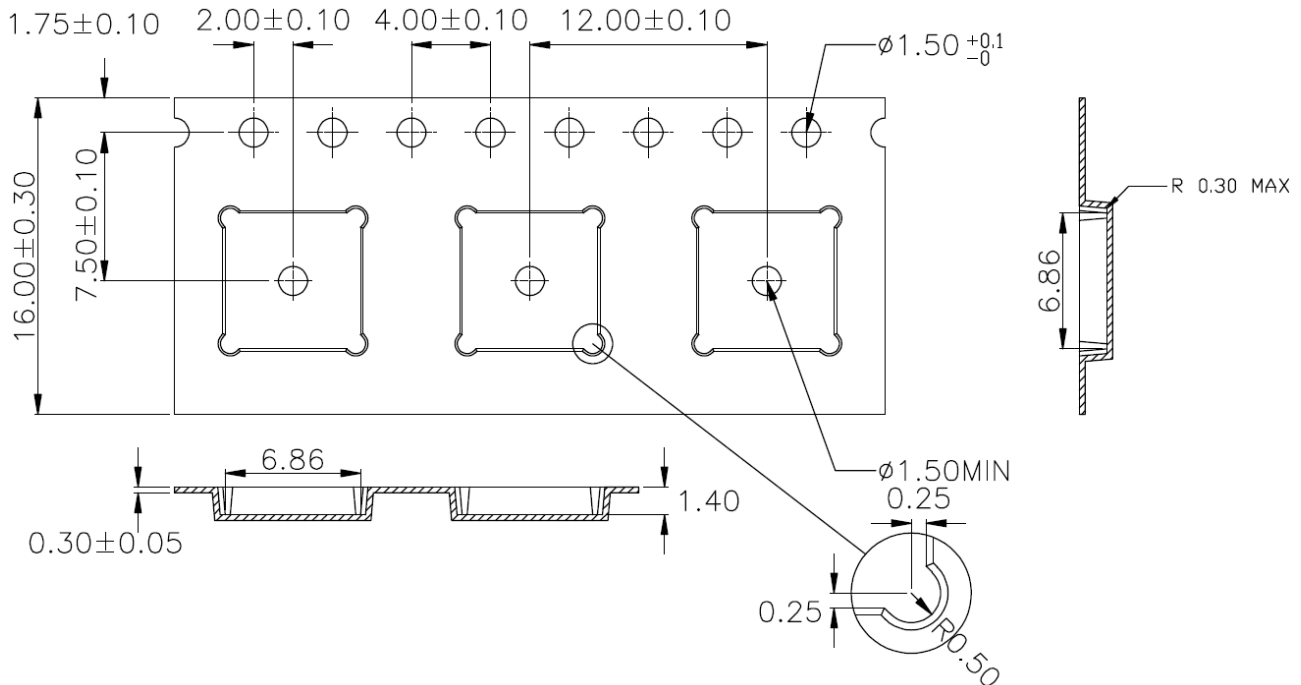

Figure 8: Orientation of ANNA-B112 modules on tape



Sprocket hole pitch cumulative tolerance ± 0.20 .

Carrier camber is within 1 mm in 250mm.

Material: Black Conductive Polyester Allow (ABS+PS).

All dimensions meet EIA-481-D requirements.

Thickness: 0.30 ± 0.05 mm.

Surface resistivity: $105 \sim 109 \Omega/\text{sq}$.

Figure 9: ANNA-B112 tape dimensions

8.4 Moisture sensitivity levels

- The ANNA-B112 modules are Moisture Sensitive Devices (MSD) in accordance with the IPC/JEDEC specification.

The Moisture Sensitivity Level (MSL) relates to the required packaging and handling precautions. The ANNA-B112 modules are rated at MSL level 3.

- For MSL standards, see IPC/JEDEC J-STD-020, which can be downloaded from www.jedec.org.

8.5 Reflow soldering

Reflow profiles are to be selected according to u-blox recommendations. See ANNA-B112 System Integration Manual [1] for more information.

 Failure to observe these recommendations can result in severe damage to the device.

8.6 ESD precautions

 The ANNA-B112 modules contain highly sensitive electronic circuitry and are Electrostatic Sensitive Devices (ESD). Handling the ANNA-B112 modules without proper ESD protection may destroy or damage them permanently.

The ANNA-B112 modules are electrostatic sensitive devices (ESD) and require special ESD precautions typically applied to ESD sensitive components. Section 4.1.1 provides the maximum ESD ratings of the ANNA-B112 modules.

Proper ESD handling and packaging procedures must be applied throughout the processing, handling and operation of any application that incorporates the ANNA-B112 module. The ESD precautions should be implemented on the application board where the module is mounted as described in the ANNA-B112 System Integration Manual [1].

 Failure to observe these recommendations can result in severe damage to the device.

9 Marking and ordering information

9.1 Product marking

The marking on the ANNA-B112 modules include important product information as described in this section. Figure 8 illustrates the laser marking of all the ANNA-B112 modules, which include production date, product type number and version.



Figure 10: Product marking on the ANNA-B112 module

Item	Description																																																			
Dot	Pin 1 corner indication for assembly orientation.																																																			
Line 1	Product name, major version and product grade ANNAB112: Product name TT = Major product version Q = Quality grade																																																			
Line 2	Minor version and production date XX = Minor product version 8 = Y = Last digit of production year 36 = WW = Week number of production date E1 = EE = Assembly mother lot, last digits 001 = SSS: Assembly sub lot number																																																			
2D code	<table border="1"> <thead> <tr> <th></th> <th>1</th> <th>2</th> <th>3</th> <th>4</th> <th>5</th> <th>6</th> <th>7</th> <th>8</th> <th>9</th> <th>10</th> <th>11</th> <th>12</th> <th>13</th> <th>14</th> <th>15</th> <th>16</th> </tr> <tr> <th></th> <th colspan="2">Year</th> <th colspan="4">Assembly Mother Lot#</th> <th colspan="3">Sub Lot#</th> <th colspan="2">Strip#</th> <th colspan="2">Y axis</th> <th colspan="2">X axis</th> </tr> </thead> <tbody> <tr> <td>Example</td> <td>8</td> <td></td> <td>3</td> <td>6</td> <td>U</td> <td>B</td> <td>E</td> <td>1</td> <td>0</td> <td>0</td> <td>1</td> <td>0</td> <td>1</td> <td>0</td> <td>1</td> <td>0</td> <td>1</td> </tr> </tbody> </table>		1	2	3	4	5	6	7	8	9	10	11	12	13	14	15	16		Year		Assembly Mother Lot#				Sub Lot#			Strip#		Y axis		X axis		Example	8		3	6	U	B	E	1	0	0	1	0	1	0	1	0	1
	1	2	3	4	5	6	7	8	9	10	11	12	13	14	15	16																																				
	Year		Assembly Mother Lot#				Sub Lot#			Strip#		Y axis		X axis																																						
Example	8		3	6	U	B	E	1	0	0	1	0	1	0	1	0	1																																			

Table 22: ANNA-B112 marking description

9.2 Explanation of codes

Three different product code formats are used. The **Product Name** is used in documentation such as this data sheet and identifies all u-blox products, independent of packaging and quality grade. The **Ordering Code** includes options and quality, while the **Type Number** includes the hardware and software versions. Table 23 below details these three different formats:

Format	Structure
Product Name	PPPP-TGVV
Ordering Code	PPPP-TGVV-TTQ
Type Number	PPPP-TGVV-TTQ-XX

Table 23: Product code formats

Table 24 explains the parts of the product code.

Code	Meaning	Example
PPPP	Form factor	ANNA
TG	Platform (Technology and Generation) T – Dominant technology, For example, W: Wi-Fi, B: Bluetooth G – Generation	B1: Bluetooth Generation 1
VV	Variant based on the same platform; range [00...99]	12: default mounting, with internal antenna
TT	Major Product Version	00: first revision
Q	Quality grade <ul style="list-style-type: none"> • A: Automotive • B: Professional • C: Standard 	B: professional grade
XX	Minor product version (not relevant for certification)	Default value is 00

Table 24: Part identification code

9.3 Ordering information

Ordering Code	Product
ANNA-B112-00B	ANNA-B1 module with the option to use either an internal antenna or an external antenna, preflashed with u-blox connectivity software v1.0.0

Table 25: Product ordering codes

Appendix

A Glossary

Abbreviation	Definition
ADC	Analog to Digital Converter
BLE	Bluetooth Low Energy
BPF	Band Pass Filter
CTS	Clear To Send
ESD	Electro Static Discharge
FCC	Federal Communications Commission
GATT	Generic ATtributed profile
GPIO	General Purpose Input/Output
IC	Industry Canada
I ² C	Inter-Integrated Circuit
LPO	Low Power Oscillator
MCU	Micro Controller Unit
MSD	Moisture Sensitive Device
RF	Radio Frequency
RTOS	Real Time Operating System
SiP	System in Package
SPI	Serial Peripheral Interface
UART	Universal Asynchronous Receiver/Transmitter

Table 26: Explanation of the abbreviations and terms used

Related documents

- [1] ANNA-B112 System Integration Manual, document number UBX-18009821
- [2] u-blox Short Range AT Commands Manual, document number UBX-14044127
- [3] ANNA-B112 Getting Started Guide, document number UBX-18020387
- [4] ANNA-B112 Declaration of Conformity, document number UBX-18058993

 For regular updates to u-blox documentation and to receive product change notifications, register on our homepage (www.u-blox.com).

Revision history

Revision	Date	Name	Comments
R01	28-Mar-2018	mwej, kgom	Initial release.
R02	14-May-2018	mwej, kgom	Changed product status to Engineering Sample. Updated main features summary (Table 1) and the block diagram (Figure 1). Updated the countries for modular type approvals (section 1.1 and 6.1).
R03	15-Nov-2018	mwej, hekf, kgom	Changed product status to Initial Production. Updated RoHS compliance from RoHS 2 to RoHS 3. Inserted table of antenna radiation patterns. Updated package thickness and added missing dimensions in the mechanical drawing. Updated the number of units on a reel in section 8.2. Included information about Approved antennas in section 7.1. Added reference to the ANNA-B112 Getting Started Guide. Updated range figures in Table 1. Updated product marking in section 9.1. Updated information about the completed certifications for ETSI (Europe), FCC (USA), IC (Canada), Japan (sections 6.2, 6.3 and 6.4). Updated Tape information in section 8.3. Added Bluetooth qualification listing information in section 6.7.
R04	24-Dec-2018	mwej, hekf	Added information about the completed certification for Taiwan (section 6.5).

Contact

For complete contact information, visit us at www.u-blox.com.

u-blox Offices

North, Central and South America

u-blox America, Inc.

Phone: +1 703 483 3180
E-mail: info_us@u-blox.com

Regional Office West Coast:

Phone: +1 408 573 3640
E-mail: info_us@u-blox.com

Technical Support:

Phone: +1 703 483 3185
E-mail: support@u-blox.com

Headquarters

Europe, Middle East, Africa

u-blox AG

Phone: +41 44 722 74 44
E-mail: info@u-blox.com
Support: support@u-blox.com

Asia, Australia, Pacific

u-blox Singapore Pte. Ltd.

Phone: +65 6734 3811
E-mail: info_ap@u-blox.com
Support: support_ap@u-blox.com

Regional Office Australia:

Phone: +61 2 8448 2016
E-mail: info_anz@u-blox.com
Support: support_ap@u-blox.com

Regional Office China (Beijing):

Phone: +86 10 68 133 545
E-mail: info_cn@u-blox.com
Support: support_cn@u-blox.com

Regional Office China (Chongqing):

Phone: +86 23 6815 1588
E-mail: info_cn@u-blox.com
Support: support_cn@u-blox.com

Regional Office China (Shanghai):

Phone: +86 21 6090 4832
E-mail: info_cn@u-blox.com
Support: support_cn@u-blox.com

Regional Office China (Shenzhen):

Phone: +86 755 8627 1083
E-mail: info_cn@u-blox.com
Support: support_cn@u-blox.com

Regional Office India:

Phone: +91 80 405 092 00
E-mail: info_in@u-blox.com
Support: support_in@u-blox.com

Regional Office Japan (Osaka):

Phone: +81 6 6941 3660
E-mail: info_jp@u-blox.com
Support: support_jp@u-blox.com

Regional Office Japan (Tokyo):

Phone: +81 3 5775 3850
E-mail: info_jp@u-blox.com
Support: support_jp@u-blox.com

Regional Office Korea:

Phone: +82 2 542 0861
E-mail: info_kr@u-blox.com
Support: support_kr@u-blox.com

Regional Office Taiwan:

Phone: +886 2 2657 1090
E-mail: info_tw@u-blox.com
Support: support_tw@u-blox.com

X-ON Electronics

Largest Supplier of Electrical and Electronic Components

Click to view similar products for [WiFi Modules \(802.11\)](#) category:

Click to view products by [U-Blox](#) manufacturer:

Other Similar products are found below :

[SX-PCEAN2C-SP](#) [BCM43602KMLG](#) [7265.NGWG.W](#) [ENW-49801A1JF](#) [WH-M2SD50NBT](#) [SX-680-2700-SP](#) [RN171-IRM481](#) [FXX-3061-MIX](#) [9668C52W10E](#) [EMIO-1533-00A2](#) [EWM-W162M201E](#) [ISM43340-L77-TR](#) [BCM4352KMLG](#) [BCM43520KMLG](#) [BCM43217KMLG](#) [7265.NGWWB.W](#) [PPC-WL-KIT02-R11](#) [RC-CC2640-A](#) [M113DH3200PS3Q0](#) [SX-PCEAN2c](#) [WT-01F](#) [WT32-S1](#) [WT-01N](#) [ESP32-WROVER-IB\(8MB\)](#) [ESP32-WROOM-32D\(16MB\)](#) [ESP-WROOM-02D\(4MB\)](#) [ESP32-WROVER\(IPEX 4MB\)](#) [EAR00370](#) [EAR00373](#) [EAR00364](#) [ATSAMW25H18-MR210PB1961](#) [3168.NGWG](#) [MY-WF003U](#) [EWM-W188M201E](#) [EWM-W190H01E](#) [EWM-W190H02E](#) [2700442](#) [1012](#) [1030](#) [MOD-NRF8001](#) [BTM-112](#) [WIZFI250-H](#) [WT51822-S4AT](#) [WT8266-S2](#) [TDKEZWIFI](#) [WIZFI210-CA](#) [RN171XVS-I/RM](#) [MRF24WG0MA-I/RM](#) [ATWILC1000-MR1100B](#) [ATWILC1000-MR110PB](#)