

BCR430U

Low Drop Voltage LED Driver IC

Feature list

- Supply voltage from 6 V to 42 V
- Controls up to 100 mA LED current
- Typ. 135 mV saturation voltage at 50 mA
- LED current precision $\pm 5\%$ at 95mA
- Smart over temperature protection function

Advantages with respect to discrete solutions

- Low BOM count
- Lower assembly cost
- Smaller form factor
- Higher reliability due to less parts and soldering joints

Potential Applications

- LED strips
- LED displays and channel letters
- Architectural and landscape lighting
- Retail lighting

Product Validation

- Qualified for industrial applications according to the relevant tests of JEDEC47/20/22

Product Name	Package	Marking
BCR430U	PG-SOT23-6-1	43

Description

BCR430U is a linear LED controller IC in a small PG-SOT23-6-1 package regulating the LED current in standalone operation without any external power transistor. The IC supply voltage range is from 6 V up to 42 V. The LED current level can be adjusted up to 100 mA connecting a high ohmic resistor R_{set} to pin RS. The voltage drop at the integrated LED driver stage is less than 200 mV at 50 mA improving the overall system efficiency and providing extra voltage headroom to compensate for tolerances of LED forward voltage or supply voltage. The smart over temperature protection function reduces the LED current when junction temperature of BCR430U is very high.

Table of contents

	Feature list	1
	Advantages with respect to discrete solutions	1
	Potential Applications	1
	Description	1
	Table of contents	2
1	Application circuit	3
2	Pin configuration	3
3	Functional description	4
4	Electrical characteristics and parameters	6
5	Package dimensions	8
6	References	10
	Revision history	10
	Disclaimer	11

Application circuit

1 Application circuit

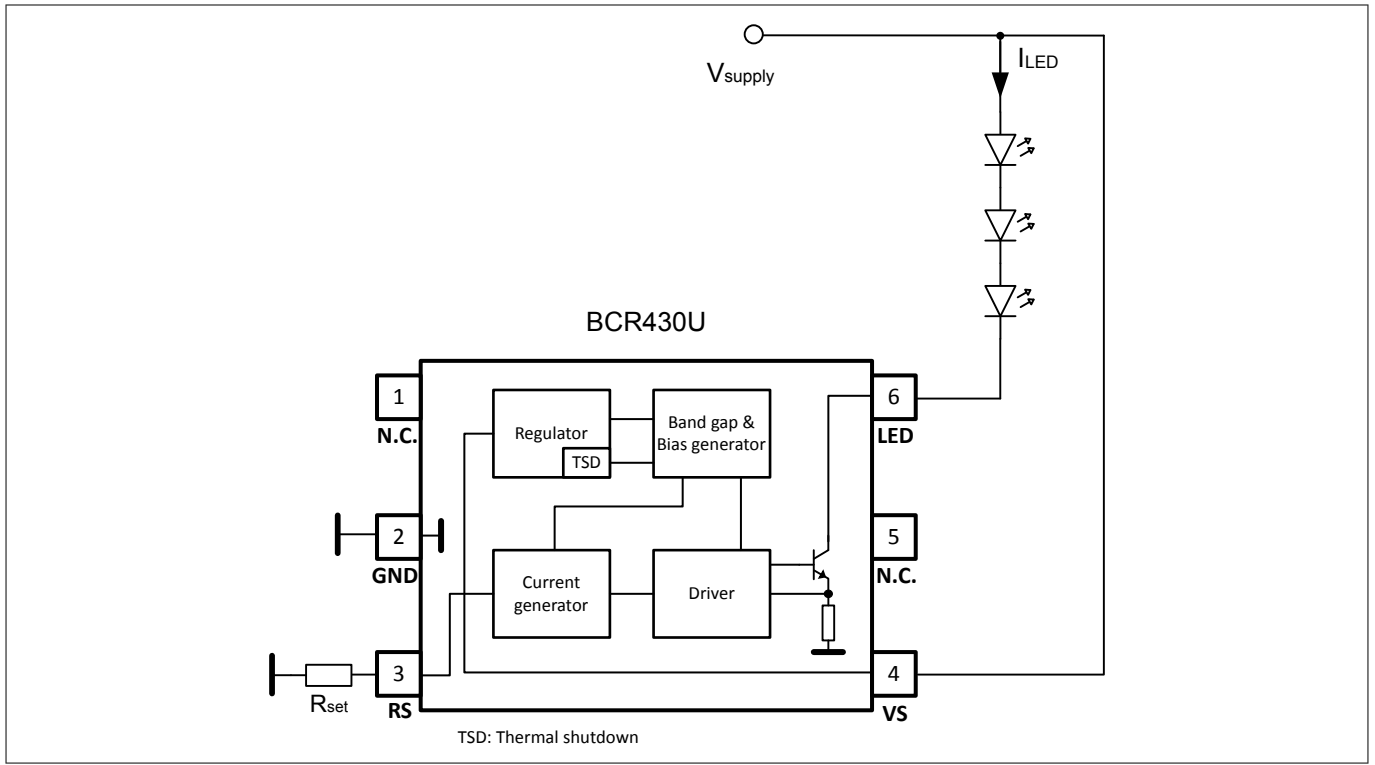

Figure 1 Typical Application Circuit of BCR430U

2 Pin configuration

Pin No.	Pin Name	Pin Type	Function
1	N.C.	-	Not connected
2	GND	GND	IC ground & thermal connection to heat spreader on PCB
3	RS	Output	Connection of Rset resistor
4	VS	Input	Supply voltage
5	N.C.	-	Not connected
6	LED	Input	Driver pin to control the LED current

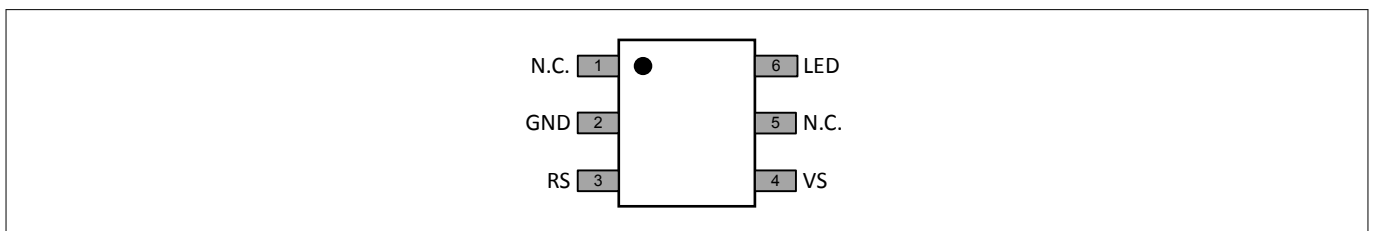

Figure 2 Pinout BCR430

Functional description

3 Functional description

LED current configuration

The LED current is configured by the external resistor R_{set} at pin RS. The current flowing into pin LED is proportional to the current flowing out of pin RS by a ratio of about 520:1. Therefore, the LED current depends on the value of R_{set} .

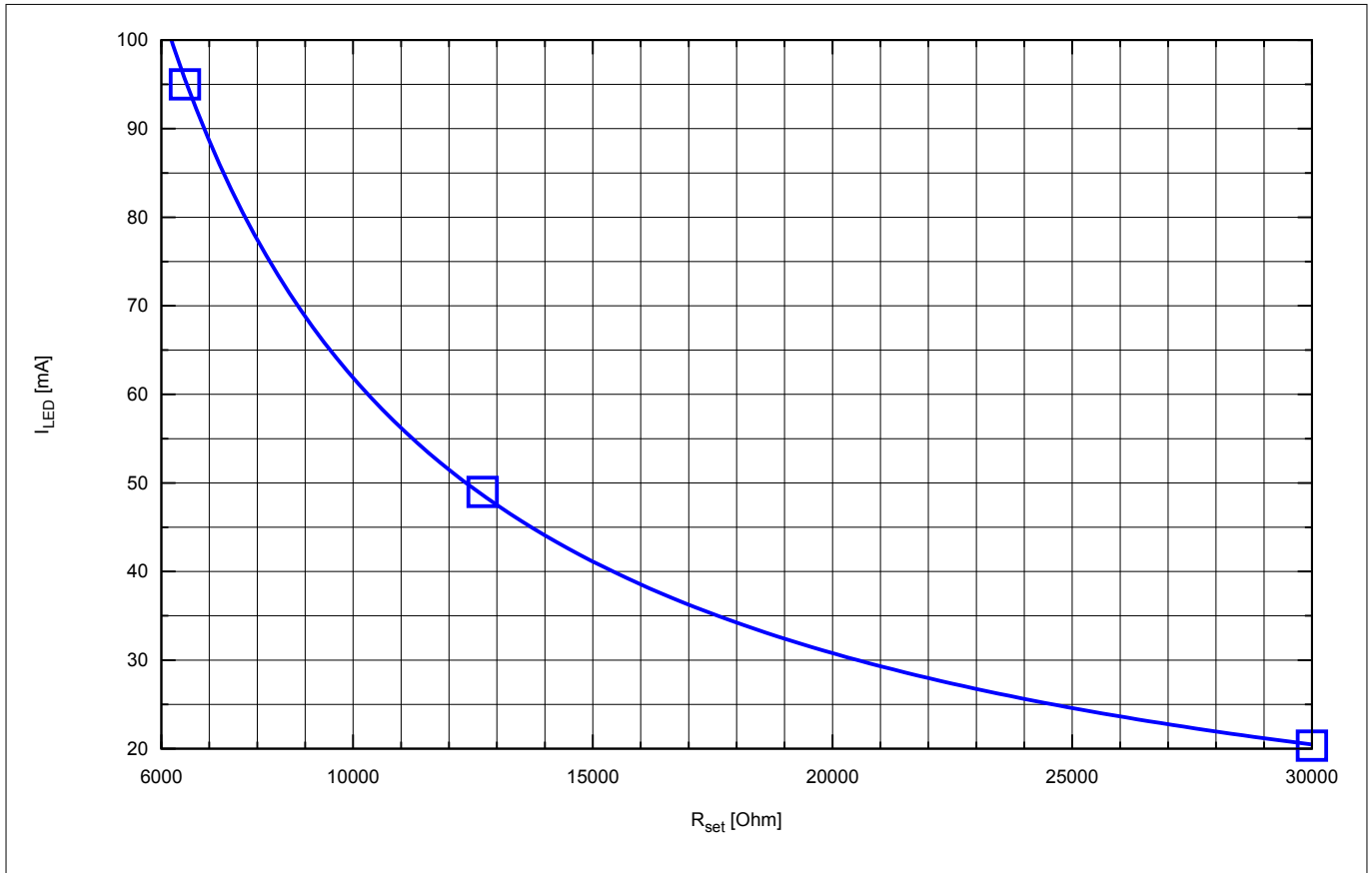

Figure 3 Relation between I_{LED} and R_{set}

Functional description

Smart over temperature protection function

BCR430U reduces the LED current with increasing junction temperature by reducing the voltage at pin RS. The reduced voltage of pin RS drives less current through the external resistor Rset, causing the current into pin LED to reduce. The LED current is never turned off fully.

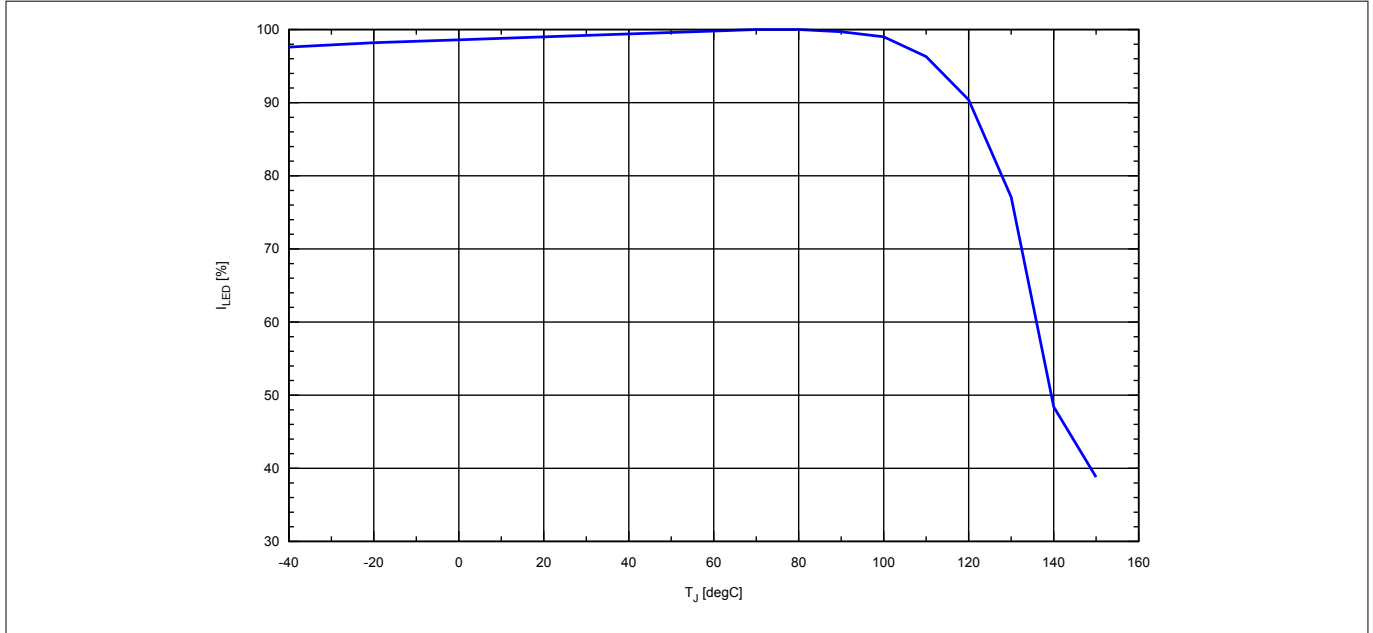

Figure 4 Relative reduction of LED current versus junction temperature of BCR430U

Maximum Permitted Power Dissipation

To avoid damage of the IC the power dissipation of BCR430U must be reduced with increasing ambient temperature according to [Figure 5](#).

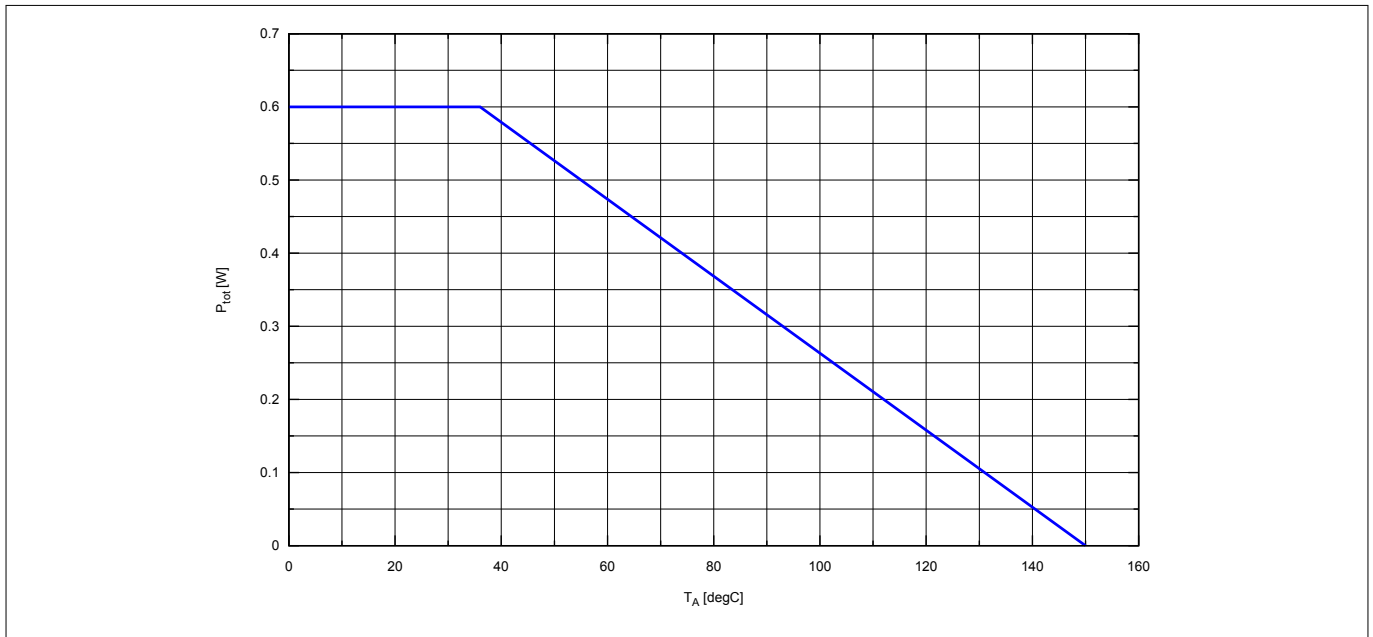

Figure 5 Maximum permitted total power dissipation of BCR430U on a JESD 51-7 board

Electrical characteristics and parameters

4 Electrical characteristics and parameters

Table 1 Maximum Ratings at $T_A = 25\text{ }^\circ\text{C}$, unless otherwise specified

Parameter	Symbol	Values			Unit	Note or test condition
		Min.	Typ.	Max.		
Junction temperature	T_J	-40	-	150	$^\circ\text{C}$	
Supply voltage	V_S	0	-	45	V	
Voltage at LED pin	V_{LED}	0	-	20	V	
Driver LED current	I_{LED}	0	-	100	mA	
RS output current	I_{RS}	0	-	0.3	mA	
Power dissipation	P_{tot}	-	-	600	mW	JESD 51-7 test board, $T_A \leq 36\text{ }^\circ\text{C}$
ESD robustness	$V_{ESD,HBM}$	-	-	1	kV	HBM according to JEDEC JS-001

Attention: Stresses above the max. values listed here may cause permanent damage to the device. Exposure to absolute maximum rating conditions for extended periods may affect device reliability. Maximum ratings are absolute ratings; exceeding only one of these values may cause irreversible damage to the integrated circuit.

Table 2 Thermal Resistance at $T_A = 25\text{ }^\circ\text{C}$, unless otherwise specified

Parameter	Symbol	Values			Unit	Note or Test Condition
		Min.	Typ.	Max.		
Thermal resistance junction to ambient	$R_{thJA,1s0p,0}$	-	-	288	K/W	JEDEC 1s0p (JESD 51-3) footprint w/o extra cooling area
	$R_{thJA,1s0p,300}$	-	-	182	K/W	JEDEC 1s0p (JESD 51-3) with 300 mm ² cooling area connected to GND pin
	$R_{thJA,2s2p}$	-	-	190	K/W	JEDEC 2s2p (JESD 51-7)
Thermal resistance junction to soldering pint	R_{thJS}	-	70	-	K/W	

Table 3 Electrical Characteristics at $T_A = 25\text{ }^\circ\text{C}$, unless otherwise specified

Parameter	Symbol	Values			Unit	Note or Test Condition
		Min.	Typ.	Max.		
Supply voltage	V_S	6	-	42	V	Operational voltage range
Supply current	I_S	1.2	1.7	2.2	mA	$I_{LED} = 50\text{ mA}$, $V_S = 6\text{ V}$
		1.3	1.8	2.3		$I_{LED} = 50\text{ mA}$, $V_S = 42\text{ V}$

Electrical characteristics and parameters

Table 3 Electrical Characteristics at $T_A = 25\text{ }^\circ\text{C}$, unless otherwise specified (continued)

Parameter	Symbol	Values			Unit	Note or Test Condition
		Min.	Typ.	Max.		
Driver LED current range	I_{LED}	5	-	100	mA	
Driver LED current by R_{set}	I_{LED}	18.0	20.4	22.7	mA	$R_{set} = 30\text{ k}\Omega$
		45.7	49	52.3		$R_{set} = 12.7\text{ k}\Omega$
		90	95	100		$R_{set} = 6.49\text{ k}\Omega$
Driver saturation voltage	$V_{LED,sat}$	70	135	200	mV	$I_{LED} = 50\text{ mA}$
RS pin voltage	V_{RS}	1.16	1.20	1.24	V	$I_{RS} = 0\text{ }\mu\text{A}$
		1.15	1.19	1.23		$I_{RS} = 200\text{ }\mu\text{A}$

Package dimensions

5 Package dimensions

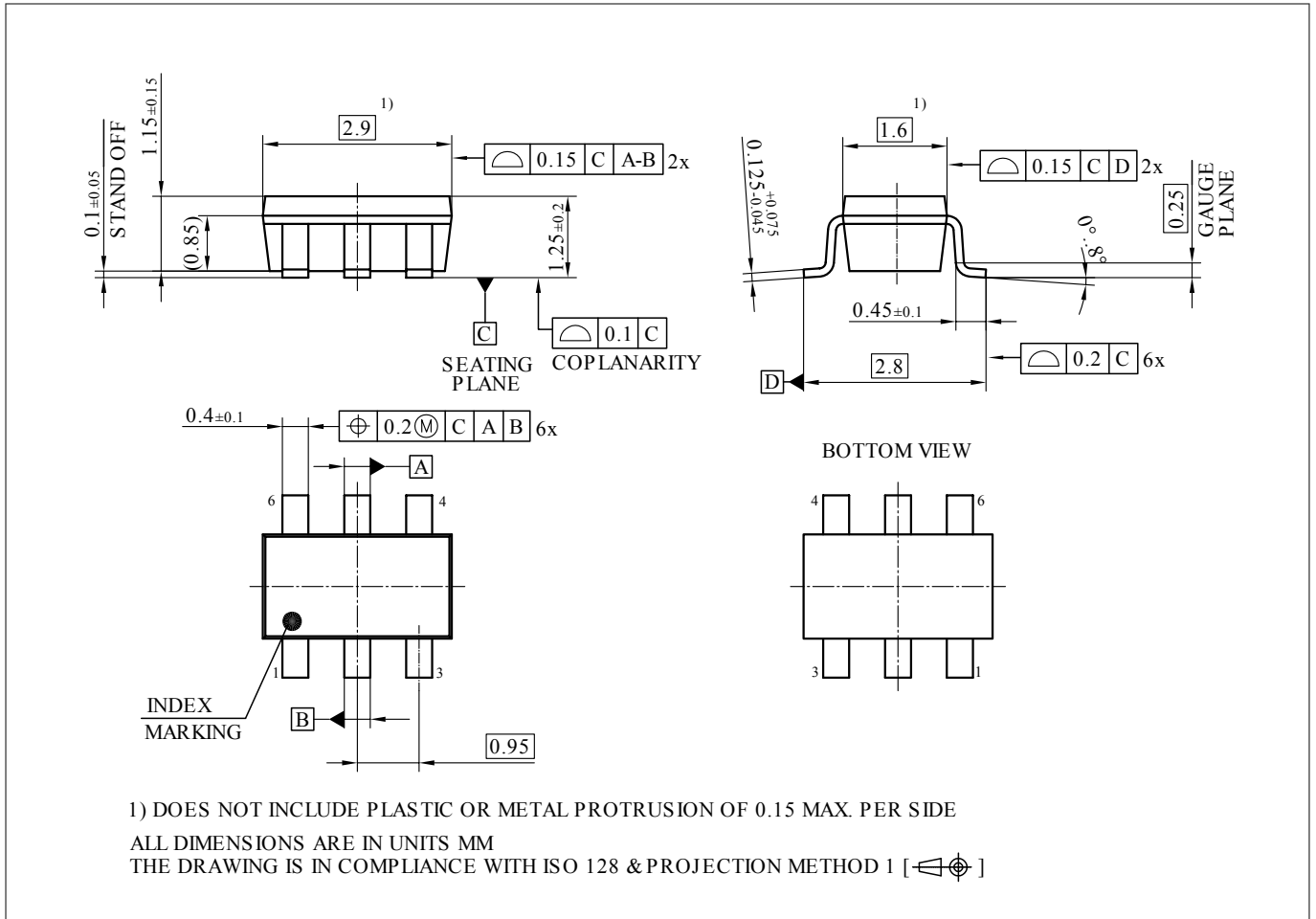

Figure 6 Package outline PG-SOT23-6-1

Package dimensions

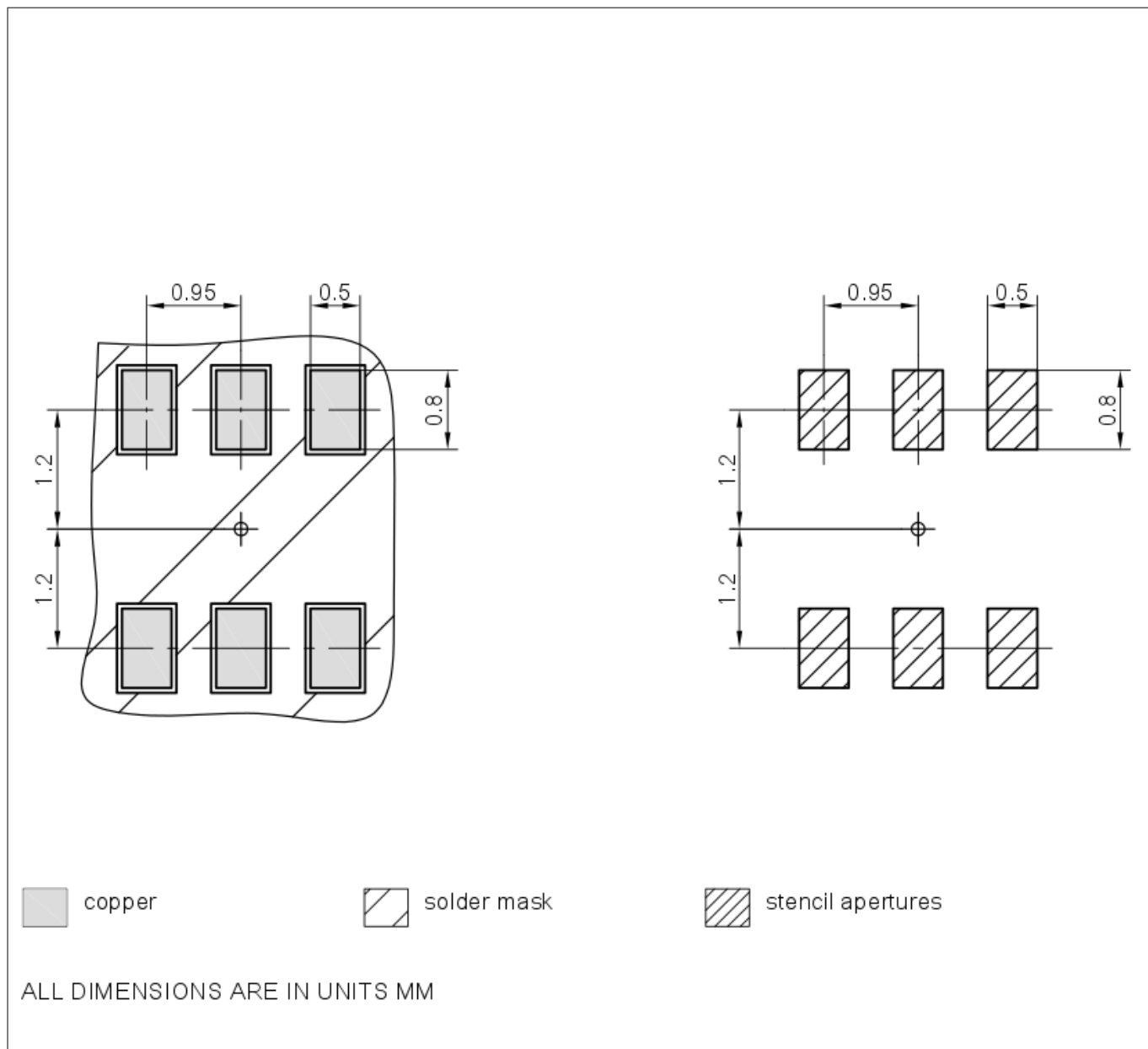

Figure 7 Footprint PG-SOT23-6-1

References

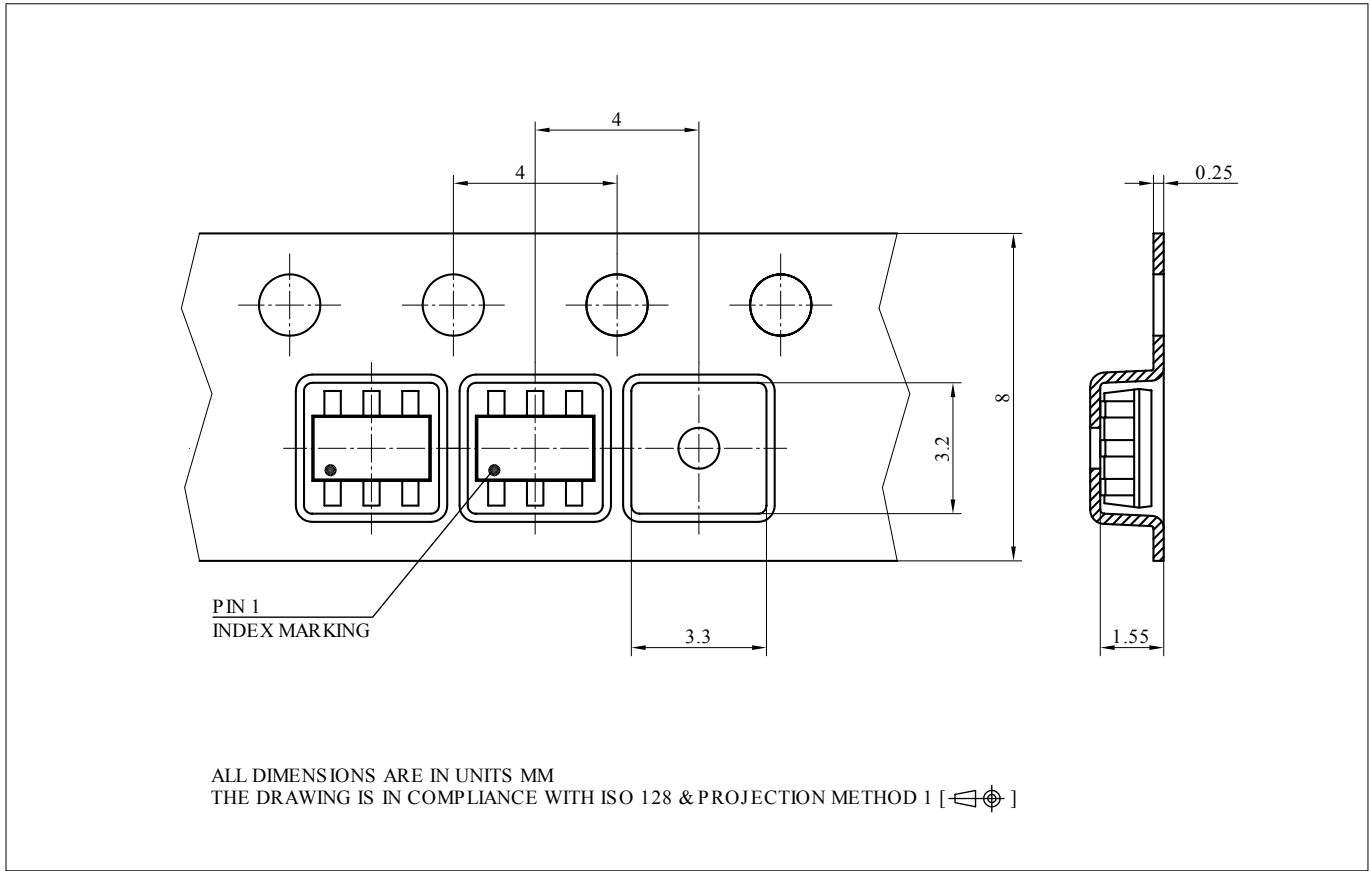

Figure 8 Tape & Reel PG-SOT23-6-1

6 **References**

Revision history

Document version	Date of release	Description of changes
1.0	2017-10-09	First version of data sheet

Trademarks

All referenced product or service names and trademarks are the property of their respective owners.

Edition 2017-10-09

Published by
Infineon Technologies AG
81726 Munich, Germany

© 2017 Infineon Technologies AG
All Rights Reserved.

Do you have a question about any
aspect of this document?
Email: erratum@infineon.com

Document reference
IFX-rso1496044693434

IMPORTANT NOTICE

The information given in this document shall in no event be regarded as a guarantee of conditions or characteristics ("Beschaffheitsgarantie").

With respect to any examples, hints or any typical values stated herein and/or any information regarding the application of the product, Infineon Technologies hereby disclaims any and all warranties and liabilities of any kind, including without limitation warranties of non-infringement of intellectual property rights of any third party.

In addition, any information given in this document is subject to customer's compliance with its obligations stated in this document and any applicable legal requirements, norms and standards concerning customer's products and any use of the product of Infineon Technologies in customer's applications.

The data contained in this document is exclusively intended for technically trained staff. It is the responsibility of customer's technical departments to evaluate the suitability of the product for the intended application and the completeness of the product information given in this document with respect to such application.

WARNINGS

Due to technical requirements products may contain dangerous substances. For information on the types in question please contact your nearest Infineon Technologies office.

Except as otherwise explicitly approved by Infineon Technologies in a written document signed by authorized representatives of Infineon Technologies, Infineon Technologies' products may not be used in any applications where a failure of the product or any consequences of the use thereof can reasonably be expected to result in personal injury

X-ON Electronics

Largest Supplier of Electrical and Electronic Components

Click to view similar products for [LED Display Drivers](#) category:

Click to view products by [Infineon](#) manufacturer:

Other Similar products are found below :

[MAP9000QNRH](#) [AP5726WUG-7](#) [AL8806QMP-13](#) [AP5726FDCG-7](#) [AS3693B-ZTQT](#) [AP5725WUG-7](#) [MAX139EQH+D](#) [STP16DP05PTR](#)
[STP16CPP05PTR](#) [STP16CPP05XTTR](#) [LV5236VZ-TLM-H](#) [BP9911CC](#) [ZXLD1366QEN8TC](#) [MT7725D](#) [TX6143](#) [SY6813PEC](#) [SD1002L4](#)
[AW3643CSR](#) [MP3370GN-Z](#) [LA2284L-G09-T](#) [SEDA](#) [SCT2027CSSG](#) [LYT3315D](#) [LYT3324D](#) [LYT4211E2](#) [LYT4214E2](#) [LYT4215E2](#)
[LYT4217E2](#) [LYT4218E2](#) [LYT4222E](#) [LYT4317E2](#) [LYT4321E](#) [LYT4323E](#) [LYT4324E3](#) [LYT4326E3](#) [TPS92020DR](#) [TPS92691PWPR](#)
[BCR420U](#) [HV9801ALG-G](#) [IS31FL3199-QFLS2-TR](#) [IS31FL3731-QFLS2-TR](#) [CAT4238TD](#) [SCT2001ASIG](#) [SCT2024CSTG](#) [SCT2167CSOG](#)
[SCT2167CSSG](#) [STP16CPPS05XTTR](#) [TLE4241GMFUMA1](#) [ICM7212MIQH+D](#) [ICM7212AIQH+D](#)