



# Light Tape Design Guide



# Table of Contents

## **A. What is Light Tape®?**

- A2. Bring Your Imagination To Light™
- A3. Prepare To Be Illuminated.
- A4. Light Tape® lamps set a new standard in EL.
- A5. Energy Consumption
- A6. Light Tape® Standard Sizes
- A7. Light Tape® Snap-N-Light™ Specifications
- A8. Color Options
- A9. Technical Specifications

## **B. Smart Driver Power Supply**

- B2. Digital Smart Driver™ AC Power Supply
- B3. Power Supply Features
- B4. DC Power Supply
- B5. Light Tape® Connector Specifications

## **C. How to Order**

- C2. How to Request a Quote
- C3. Accent Lighting Example: Top View
- C4. Backlighting Materials: Top View
- C5. Backlighting Custom Shapes

## **D. Cutting and Installation**

- D2. Light Tape® Safety & Handling
- D3. Indoor Installation
- D4. Installing Panels for Backlighting
- D5. Floor Installation
- D6. Mounting Materials
- D7. Installing Corners or Bends
- D8. Sealing & Cutting Light Tape®
- D9. Making a Connection
- D10. Connecting Multiple Segments
- D11. Snap-N-Light™ Mounting Channel Installation
- D12. Snap-N-Light™ Mounting Channel Installation (cont)
- D13. Vertical Mount
- D14. Snap-N-Light™ Length

## **E. Color Tech**

- E2. Classic Electric Blue Technical Data
- E3. Extreme Caribbean Blue Technical Data
- E4. Classic Media White Technical Data
- E5. Classic Yellow Technical Data
- E6. Extreme Blue-Green Technical Data
- E7. Extreme Green Technical Data
- E8. Extreme International Red Technical Data
- E9. Extreme Rich Red Technical Data
- E10. Classic Natural Blue Technical Data
- E11. Extreme Orange Technical Data
- E12. Extreme Pink Technical Data
- E13. Extreme Purple Technical Data



What is Light Tape®?



# Bring Your Imagination To Light™

## WHAT IS LIGHT TAPE®?

The thinnest, widest, and longest, light in the world. Light Tape™ lamps redefine electroluminescent technology. Manufactured utilizing a novel continuous coating process resulting in ultra-low-profile, lightweight panels and strips that seamlessly and evenly illuminate from edge to edge over long distances. The philosophy behind the product is simple: a light's form factor should not restrict design or artistic vision. With Light Tape®, you have the possibility to turn anything into light.



# Prepare To Be Illuminated.

Light Tape® will change the way you think about lighting.



**Easy Installation:** Flexible illumination of 100 feet (30m) or more with a single connection. Cut your installation time by 75%.

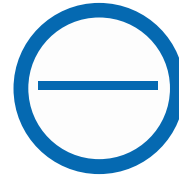

**Thin & Wide:** Thinner than a credit card and nearly a meter wide. Light Tape® can fit into any tight area and cover any surface with ease.



**Unmatched Durability:** Heavy load capable, vibration and impact resistant. Able to withstand punctures and piercings temporarily.



**Top Quality:** Built with pride utilizing the best materials and manufactured to last.

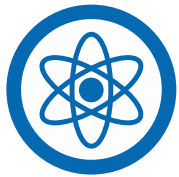

**Energy Efficient:** Light Tape® uses 40% less power than traditional LEDs at equal brightness.



**No Heat Problems:** Unlike LEDs, Light Tape® can run for 40,000 hours and never get hot. Plus, it operates in extreme temperatures.



**Custom Cut Shapes:** Illuminate non-symmetric shapes with a uniform mirror image light source. Allow your creativity to determine your lights design.

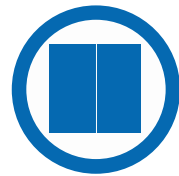

**Even Illumination:** No hot or cold spots at any size, a uniform light source without the need for diffusion.



# Energy Consumption

Light Tape® is an incredibly efficient flat accent light, with an evenly illuminated surface. Other light sources, like LEDs, directionally emit light with a great deal of the desired light either wasted or diffused in order to accomplish even illumination. When comparing the surface brightness of an accent light, there is nothing more efficient than Light Tape®.

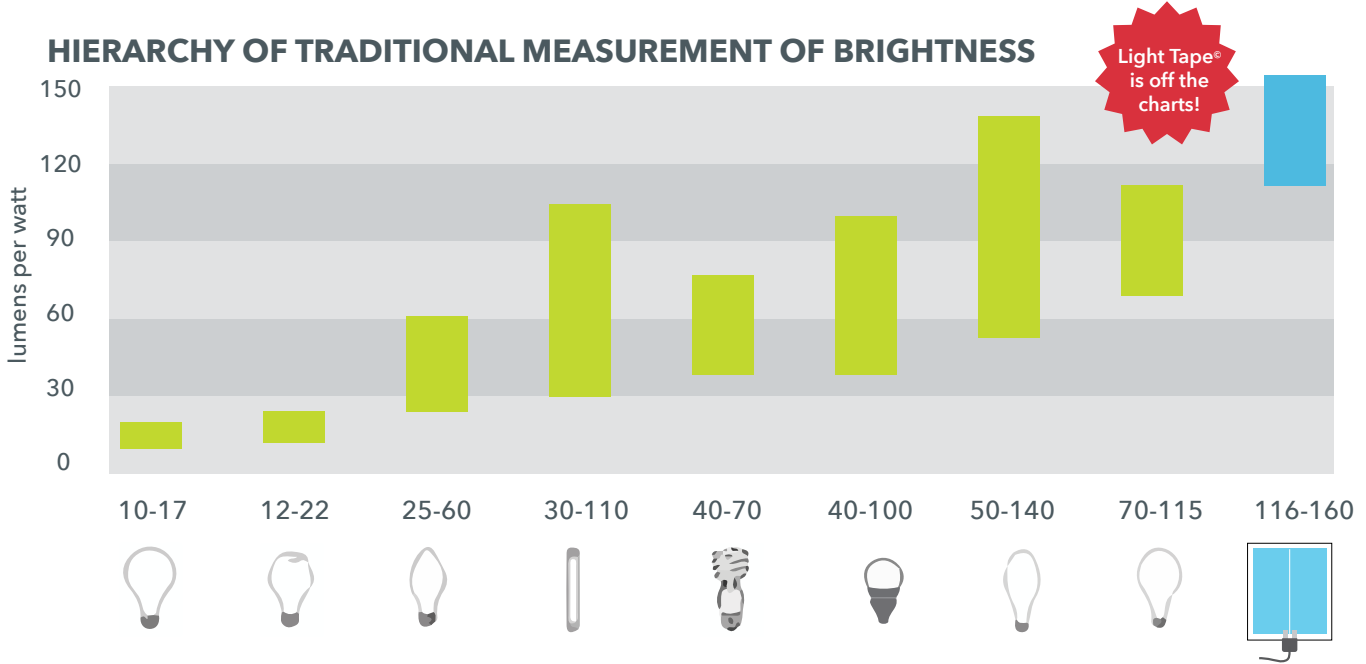

## LIGHT TAPE VS. LED ENERGY CONSUMPTION BY AREA

	ACCENT LIGHTING				BACK LIGHTING	
	LIGHT TAPE	LEDS	LIGHT TAPE	LEDS	LIGHT TAPE	LEDS
ILLUMINATED WIDTH	2.54 cm	0.8 cm	1.27 cm	0.8 cm	100% backlit	edge lit
AREA/LENGTH	1 linear meter	1 linear meter	1 linear meter	1 linear meter	square meter	square meter
ILLUMINATION SOURCE	100% phosphors	30 LEDs	100% phosphors	60 LEDs	100% phosphors	240 LEDs
CURRENT - AMPS	0.01	3	0.005	6	0.5	24
TOTAL WATTS	1	7.2	0.5	14.4	44	57.6
ILLUMINATION COVERAGE	100% even	2 cm gaps	100% even	1 cm gaps	100% even	30% dimmer in center

\*Light Tape® data based on full brightness, consumption results can be much lower when dimming.

## LIGHT TAPE POWER CONSUMPTION BY SURFACE AREA

BRIGHTNESS	A	B	C	D
	W/in <sup>2</sup>	mA/in <sup>2</sup>	W/cm <sup>2</sup>	mA/cm <sup>2</sup>
HIGH	0.028	0.342	0.0043	0.0530
AVERAGE	0.016	0.191	0.0025	0.0296
LOW	0.011	0.133	0.0017	0.020

Light Tape® consumes power in a linear fashion. With every increase in area there is an equal increase in energy required to illuminate. Multiply the illuminated surface area by the multiples to get total watts and amps.

Total Watts = (A or C) x surface area  
Total Amps = (B or D) x surface area

# Light Tape® Standard Sizes

ITEM NUMBER	ILLUMINATED WIDTH - B		LAMINATED WIDTH - A	
lt-025	0.25"	6.35 mm	0.75"	19.05 mm
lt-050	0.5"	12.7 mm	1.0"	25.4 mm
lt-100	1"	25.4 mm	1.5"	38.1 mm
lt-150	1.5"	38 mm	2"	5.07 cm
lt-200	2"	5.08 cm	2.5"	6.35 cm
lt-300	3"	7.62 cm	3.5"	8.89 cm
lt-400	4"	10.16 cm	4.5"	11.43 cm
lt-600	6"	15.24 cm	6.5"	16.51 cm
lt-1200	12"	30.48 cm	12.5"	31.75 cm
lt-1800	18"	45.72 cm	18.5"	46.99 cm
lt-2400	24"	60.96 cm	24.5"	62.23 cm
lt-3000	30"	76.2 cm	30.5"	77.47 cm

\*custom widths available

## WHEN ORDERING, PLEASE SPECIFY:

- Installation location - Interior (INT) or Exterior (EXT)
- Desired illuminated color
- Illuminated width item number
- What length for each Light Tape® lamp?
- Total number of lamps required
- Power Input - AC or DC? What input voltage?
- Extension connection tabs for backlighting applications are standard at 2" long. This allows connector to be hidden. Please advise if longer lengths are required.

## ADDITIONAL INFORMATION:

- Custom widths are possible to fit any dimensions. Light Tape® can be tiled and joined together with no seams or gaps.
- Power input location (please specify short or long side of lamp)
- A basic top or front view drawing with dimensions is helpful to our engineering team to estimate materials needed.
- We will suggest best electrical configuration for your project based on site layout.

## TOP VIEW

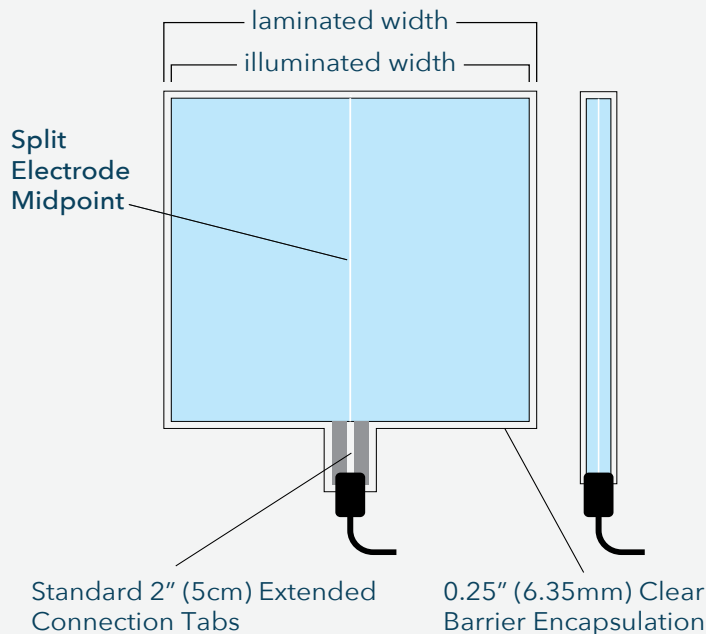

**NOTE:** the split electrode midpoint (SEMP) is a critical element of Light Tape's engineering that runs centered through the entire length.

## CROSS SECTION - SPLIT ELECTRODE

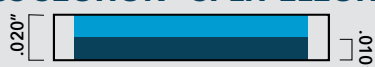



# Light Tape® Snap-N-Light™ Specifications

ITEM NUMBER	ILLUMINATED WIDTH		CHANNEL WIDTH		CLIP WIDTH	
p-lt-100	1"	25.4mm	1.67"	42.42mm	1.92"	48.90mm
p-lt-200	2"	50.8mm	2.67"	67.82mm	2.92"	74.30mm
p-lt-400	4"	101.6 mm	4.67"	119mm	4.92"	125mm

All Snap-n-Light runs are made to order.

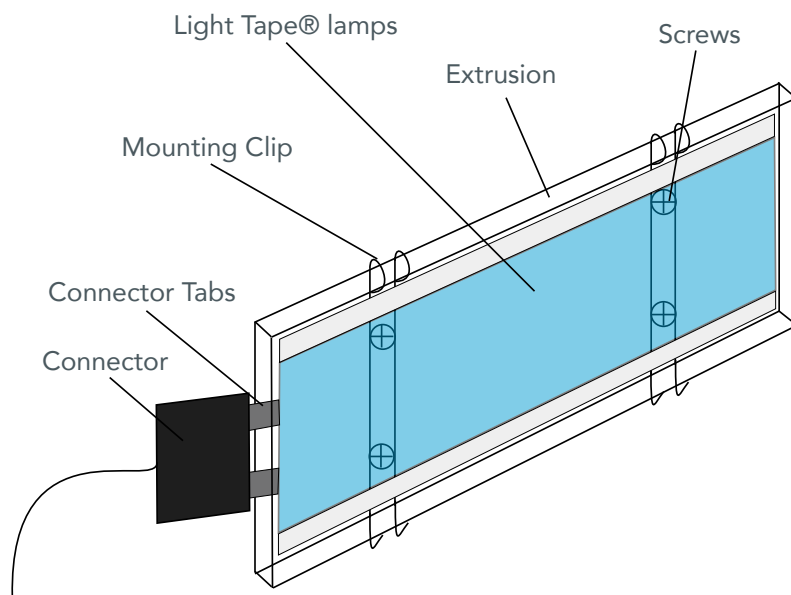

\*Mount Clip is attached to mounting surface  
Mounting Channel holds the Light Tape\* and snaps into the pre-attached mounting clips

## MOUNTING CLIP

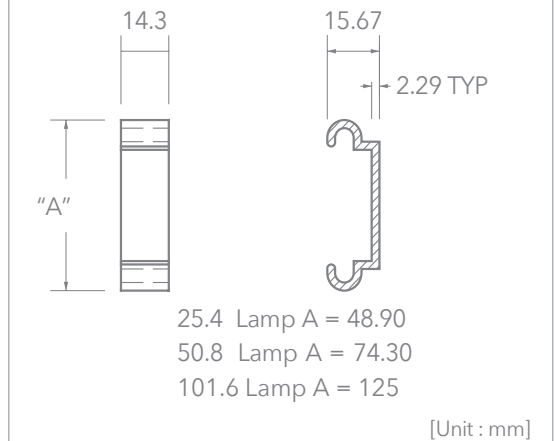

## MOUNTING CHANNEL

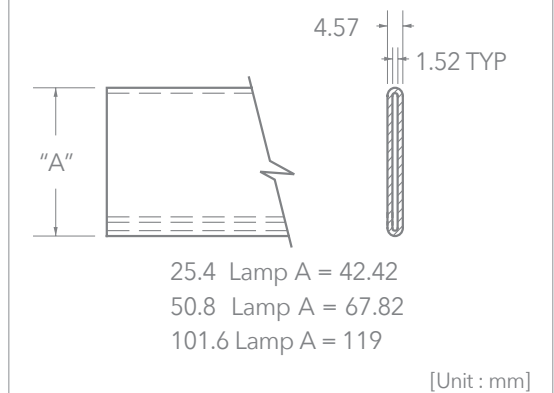

<b>Material</b>	Clear UV Stable Polycarbonate Mounting Channel
<b>Mounting Screw</b>	NO. 10
<b>Clip Placement</b>	One clip per 1 to 3 feet (30-90cm), depending on surface
<b>UV Protection</b>	Yes, and non-yellowing
<b>Roll Format</b>	Standard sizes: 25ft, 50ft, 75ft, 100ft rolls

# Color Options

Our base colors are Classic Natural Blue and Extreme Blue-Green. These colors appear white when off and colored when illuminated. We then add a filter to produce specific color options. All other colors will remain that color when not illuminated. Please check our website for updated and new colors.

For specific color data and measurements, refer to our color tech section starting on page E1.

## CLASSIC SERIES

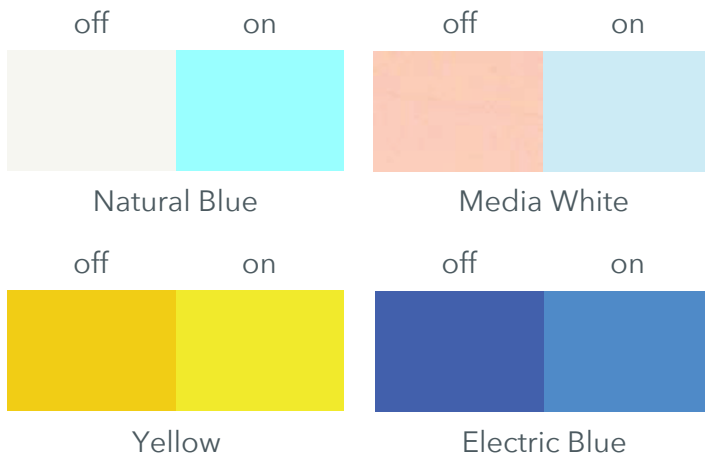

## EXTREME SERIES

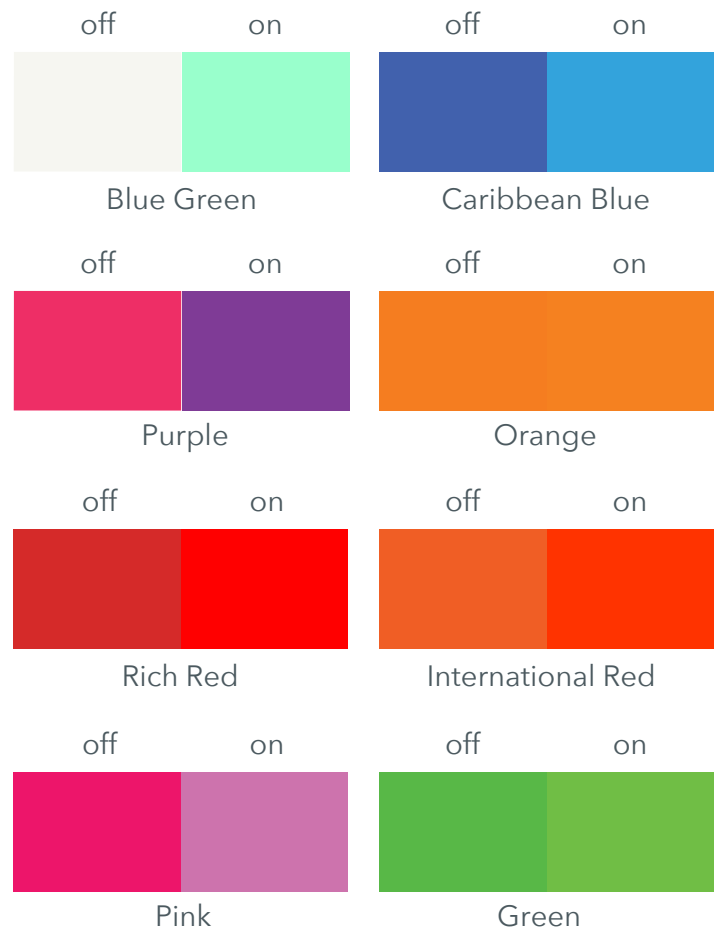

\*The colors in this table are simulated and the final product may vary. If an exact color is required, we recommend seeing a physical sample. Custom colors and widths are available, but may be subject to minimum order quantities, set-up fees, and approval testing.

# Technical Specifications

Light Tape® Physical Specifications	
Thickness (varies depending on color)	0.010 to 0.020 inches / 0.254 to 0.305 millimeters
Protective Encapsulation Seal	¼" (6.35mm) on each side (+/- 1/16 inch, +/-0.159 cm)
Light Tape® Illumination Width	0.25" to 30" / 0.625 to 76.2 cm
Illumination Coverage	Infinite, can be tiled without a break in light
Power System	
Light Tape® Load	Capacitive Load
Phase Angle	78° Leading Edge
Light Tape® Average Power Consumption by Area	0.023 watts per in <sup>2</sup> / 0.0035 watts per cm <sup>2</sup>
Light Tape® Amperage Consumption by Area**	0.19 milliamps per in <sup>2</sup> / .0296 milliamps per cm <sup>2</sup>
Light Tape® Watts per Linear Meter at 2.54 cm wide	0.4 to 1.1 watts based on low to full brightness dimming
Light Tape® Watts per Square Meter	16 to 50 watts based on low to full brightness dimming
Light Tape® Output Voltage (dimnable)	250 Volts AC, +/- 50 Volts AC
Light Tape® Operating Frequency	800 Hertz, +/- 300 Hertz (depending on tuning)
AC Driver Input Voltage Range	90 to 260 Volts AC
DC Driver Input Voltage Range	3 to 24 volts DC (12 Volts DC standard)
Power Source	ELLC Smart Driver™ Power Supplies
Controllable	Dimming, 0 to 10 Volts DC and DMX 512 Capable
Light Tape® Performance	
Useful Life - Hours	20,000 hours to excess of 40,000 hours
Useful Life - Years	up to 20 years (dependent on drive parameters)
Average Brightness	125 cd/m <sup>2</sup>
Brightness Range	0 to 200 cd/m <sup>2</sup>
Brightness Differential - Completely Uniform	+/- 1 cd/m <sup>2</sup> , independent of total surface area
Operating Temperature - Ambient	-30°C +50°C
Heat Gain During Operation	Does not produce heat during operation
Compressive Strength - Ground Pressure	500 psi or more depending on mounting system
Impact Strength - Izod (73F)	6.5 ft-lbs/in <sup>2</sup>
Flexural Strength	700>15,000 cycles ASTM D2176
Flexibility - Wrap Angle	Contours around 6 millimeter diameter object
Punctureable	Yes, will illuminate after puncturing
Maximum Processing Temperature	350°F / 177°C (depending on residence time)
Health and Safety	
Safety Features	Overload and short circuit protection. UL listed.
UL Certifications	File number E319670, 2006/95/EC
CE Certifications	EC-Attestation of conformity - No. 0704 63147 001
Low Voltage Directive	Compliant
Environmental Compliance	ROHS and WEEE Directive
EMC Emissions Compliant	EN55015 (CISPR15) Radiated and Conducted Emission
Flame Resistance	UL 94VTM-0
International Protection Marking	IP67, EN60529

\*\*Data recorded at average brightness, with AC input power of 250 Volts and 850 Hertz.



# Smart Driver™ Power Supply

# Digital Smart Driver™ AC Power Supply

Digital Smart Driver™ power supplies are specifically engineered to illuminate Light Tape®. Whether it is one piece or ten, it is possible to do it all with one Smart Driver™. There are a variety of models to choose from offering a variety of useful features. A factory representative will advise which model to use based on the total illuminated area, zones, and location.



## FEATURES:

- Quiet
- Stylish compact design
- Rated Input Voltage 110 / 220 VAC
- Protection Class 1
- IP Degree 2x
- Worldwide voltage capacity
- Blink and Dimmer Switch
- Visual LED system status indicator
- Lightweight
- Short circuit and overload protection
- Convection Air Cooled
- CE, UL, and CSA compliant
- 0-10 dimming
- DMX 512 compatible

## Driver Ranges and Output

Model	Range		Input		Output
	Imperial	Metric	Amps	Watts	Max. Current, A
SD-8000	4000 - 8000 in <sup>2</sup>	25,806 - 51,612 cm <sup>2</sup>	3.50	420	3.8
DSD 4000 0-10 DIMMING	200-4000 in <sup>2</sup>	12,903 - 25,806 cm <sup>2</sup>	1.7	204	2
DSD 1000 0-10 DIMMING	400-1000 in <sup>2</sup>	2580 cm <sup>2</sup> - 6451 cm <sup>2</sup>	0.9	97	0.32
DSD 200 0-10 DIMMING	1-200 in <sup>2</sup>	6.5 - 1290 cm <sup>2</sup>	0.5 max	12	0.022
DSD 4000 DMX	200-4000 in <sup>2</sup>	12,903 - 25,806 cm <sup>2</sup>	1.7	204	2
DSD 1000 DMX	400-1000 in <sup>2</sup>	2580 cm <sup>2</sup> - 5161 cm <sup>2</sup>	0.9	97	0.32
DSD 200 DMX	1-200 in <sup>2</sup>	6.5 - 1290 cm <sup>2</sup>	0.5 max	12	0.022
DSD 2000	1000-2000 in <sup>2</sup>	6451 - 12,903 cm <sup>2</sup>	2.8 max	68	0.91
DSD 1000	400-1000 in <sup>2</sup>	2580 cm <sup>2</sup> - 6451 cm <sup>2</sup>	0.9	97	0.32
DSD 400	200-400 in <sup>2</sup>	1290 - 2580 cm <sup>2</sup>	0.7 max	17	0.11
DSD 200	1-200 in <sup>2</sup>	6.5 - 1290 cm <sup>2</sup>	0.5 max	12	0.022

\*Max Vac is 320v at 750hz

## Smart Driver™ Safety & Handling

It is important that you operate Light Tape® and Smart Driver Power Supplies within their parameters. Changes to parameters that result in over current will damage the Light Tape® lamp and power supplies.

- Always attach Light Tape® load before powering on
- 250 volts is mid range and recommended set point
- The external dimmer switch on Smart Driver™ controls the output voltage and frequency.
- Use a voltage meter to determine volts / hertz from Smart Driver™ to Light Tape®.
- Always set power supply output voltage per factory recommended setting  
Low : 200 volts | Medium : 250 volts | High : 300 volts
- We **DO NOT** recommend exceeding 300 volts. Contact us if the Smart Driver™ is operating outside of range.
- Red LED indicates the following :
  - a. Short Circuit Protection : Check wiring if light is on.
  - b. Overload Protection: Verify that lamp area is acceptable, or for possible damage to lamp.
- Always treat Light Tape® and Smart Driver™ with care and respect as one would with any device where electrical current is present
- Damp location only - please store in appropriate NEMA enclosure for outdoor.
- Please follow local electrical codes

# Power Supply Features

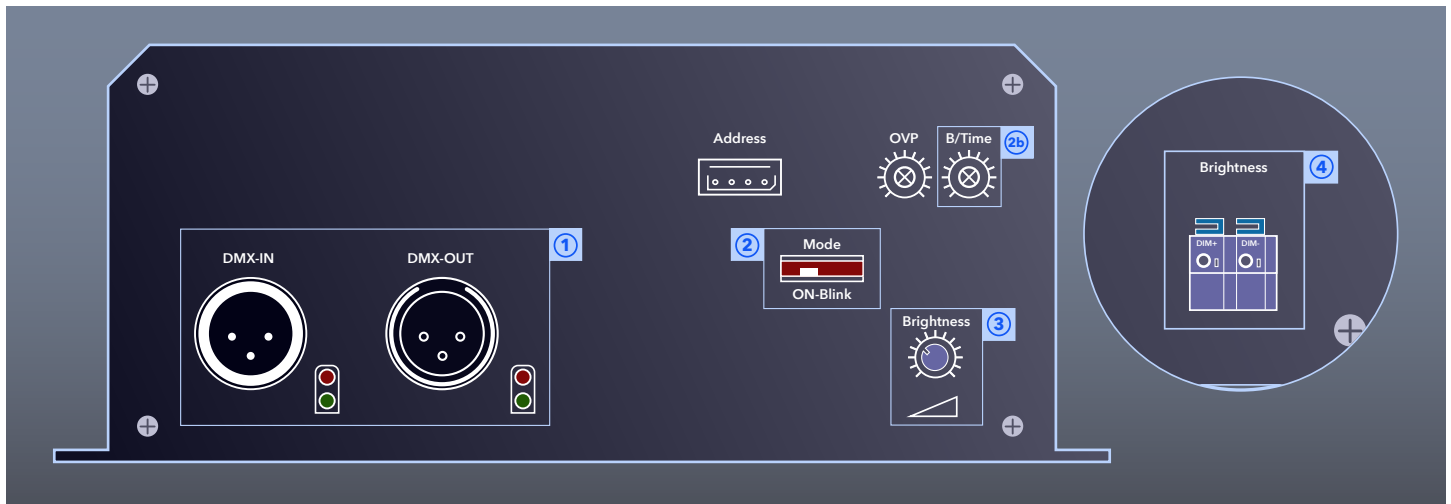

## Features

- ① **DMX Mode** - 512 Supplies are fully DMX controllable, allowing for integration into complicated stage and light shows.
- ② **Blink Mode** - Allows for on/off pulse control with fine tuning knob.
- ③ **Brightness control** - luminosity adjustment to appropriately match installation environment
- ④ **0-10 Dimming** - Optional function to remotely control Light Tape® brightness using standard 0-10v dimmers. Compatible with Lutron Dimmers.

Model	DMX	Blink Mode	Brightness Control	0-10 Dimming
SD 8000		x	x	
DSD 4000 0-10 DIMMING			x	x
DSD 1000 0-10 DIMMING			x	x
DSD 200 0-10 DIMMING			x	x
DSD 4000 DMX	x	x	x	x
DSD 1000 DMX	x			
DSD 200 DMX	x			
DSD 2000			x	
DSD 1000			x	
DSD 400			x	
DSD 200			x	

## Power Supply Dimensions

Model	Length		Width		Height		Weight
SD-8000	9 7/8 in	2.5 cm	4 3/4 in	12 cm	2 1/4 in	5.7 cm	4.15 lb
BUS-DSD-4000	8 3/4 in	22 cm	6 1/4 in	15.8 cm	3 in	7.6 cm	5.15 lb
DSD 4000 0-10 DIMMING	8 6/8 in	22 cm	7 1/4 in	18.5 cm	2 3/4 in	7 cm	4.9 lb
DSD 1000 0-10 DIMMING	7 3/4 in	19.5 cm	3 3/8 in	8.5 cm	2 in	5 cm	1.85 lb
DSD 200 0-10 DIMMING	6 in	15.5 cm	2 5/8 in	6.75 cm	1.5 in	4 cm	.8 lb
DSD 4000 DMX	8 6/8 in	22 cm	7 1/4 in	18.5 cm	2 3/4 in	7 cm	4.9 lb
DSD 1000 DMX	7 3/4 in	19.5 cm	3 3/8 in	8.5 cm	2 in	5 cm	1.85 lb
DSD 200 DMX	6 in	15.5 cm	2 5/8 in	6.75 cm	1.5 in	4 cm	.85 lb
DSD-2000	8 3/8 in	22.5 cm	3 3/8 in	8.5 cm	2 in	5 cm	2.05 lb
DSD 1000	7 3/4 in	19.5 cm	3 3/8 in	8.5 cm	2 in	5 cm	1.85 lb
DSD 400	6 5/8 in	16.5 cm	2 5/8 in	6.75 cm	1.5 in	4 cm	1.05 lb
DSD 200	4 7/16 in	11.3 mm	2 3/4 in	7.0 cm	1 5/8 in	4.1 cm	0.70 lb

# DC Power Supply

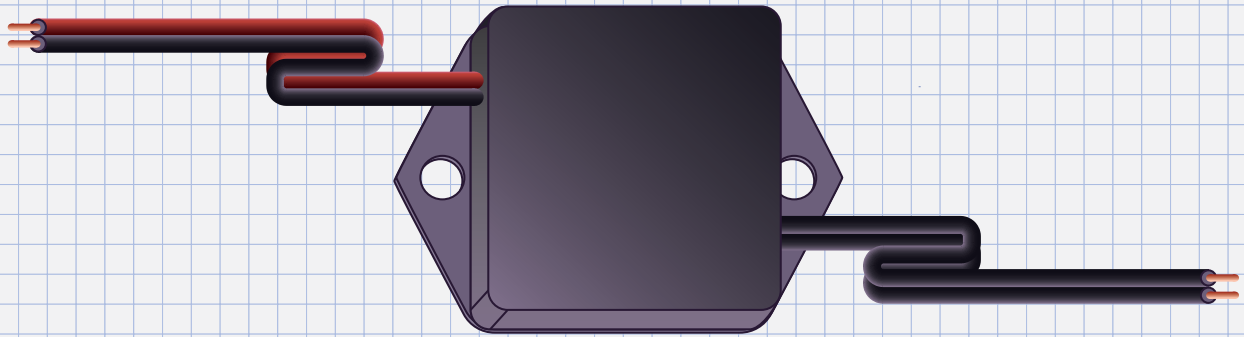

## FEATURES:

- Mountable/portable
- Compact in size
- Temperature Range: -22°F to 185°F (-30°C to 85° C)
- Accepts variety of input voltages
- High Efficiency
- Reverse Polarity protection
- No load protection
- Short circuiting protection
- Self compensating
- Quiet
- Small form factor
- CE compliant
- 6V, 12V, 24V inputs available

## Driver Ranges

Model	Light Tape Range		Input			Output
	Imperial	Metric	V	Amps	Watts	Current
DC 2000	1200-2000 in <sup>2</sup>	7741.92 - 12903.2 cm <sup>2</sup>	12v	6	72	8752 mA
DC 1500	800-1200 in <sup>2</sup>	5161.28 - 7741.92 cm <sup>2</sup>	12v	3.6	45	6564 mA
DC 750	500-800 in <sup>2</sup>	3225.8 - 5161.28 cm <sup>2</sup>	12v	2.5	30	3282 mA
DC 500	300-500 in <sup>2</sup>	967.74 - 3,225.8 cm <sup>2</sup>	12v	1.5	18	2188 mA
DC-300	150-300 in <sup>2</sup>	1612-1935 cm <sup>2</sup>	12v	0.9	10.8	1312 mA
DC 150	75 - 150 in <sup>2</sup>	516.12 - 967.74 cm <sup>2</sup>	12v	0.5	6	656 mA
DC100	50 - 100 in <sup>2</sup>	290.32 - 516.12 cm <sup>2</sup>	12v	0.4	5	438 mA
DC 50	25 - 50 in <sup>2</sup>	116.12 - 290.32 cm <sup>2</sup>	12v	0.16	2	219 mA
DC 20	10 - 25 in <sup>2</sup>	6.45 - 116.12 cm <sup>2</sup>	12v	0.08	1	88 mA
9V	≤ 30 in <sup>2</sup>	6.45 - 212.9 cm <sup>2</sup>	9v	0.2	2	144 mA

VAC Output is 260v at 800hz

## Power Supply Dimensions

Model	Length		Width		Height		Weight
DC 2000	6.5	16.51 cm	4.25 in	10.795 cm	2 in	5 cm	2.65 lb
DC 1500	6 in	15.24 cm	3.875 in	9.84 cm	1.5 in	3.8 cm	1.85 lb
DC 750	4 in	10.1 cm	3.875 in	9.84 cm	1.5 in	3.8 cm	.95 lb
DC 500	4 in	10.1 cm	3.125 in	8 cm	1.5 in	3.8 cm	.7 lb
DC-300	4 in	10.1 cm	2.125 in	5.4 cm	1.5 in	3.8 cm	.9 lb
DC 150	4 in	10.1 cm	2 in	5 cm	1.5 in	3.8 cm	.6 lb
DC100	3 in	7.6 cm	2 in	5 cm	1.5 in	3.8 cm	.45 lb
DC 50	3 in	7.6 cm	1.6 in	4 cm	1 in	2.5 cm	.2 lb
DC 20	1.75 in	4.4 cm	1 in	2.5 cm	.8 in	2 cm	.1 lb
9V	2.3 in	5.8 cm	2.3 in	5.8 cm	1 in	2.5 cm	.15 lb

# Light Tape<sup>®</sup> Connector Specifications

The entire back side of Light Tape<sup>®</sup> is conductive. Unlike other antiquated technologies, you can make a connection anywhere and Light Tape<sup>®</sup> will illuminate evenly. No need to worry about the electrode detaching from the Light Tape<sup>®</sup>. We offer a variety of connector and connecting pin options.

**Large Connector Cap for 0.5" and wider**

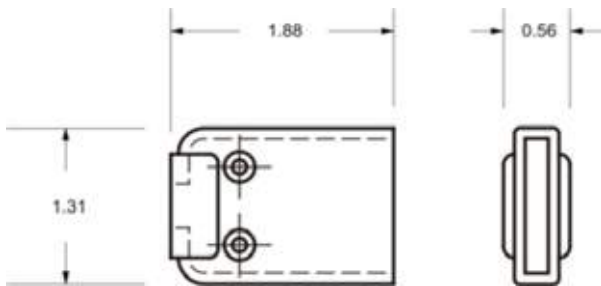

**Standard connector, strain relief, with 6 foot black lead**

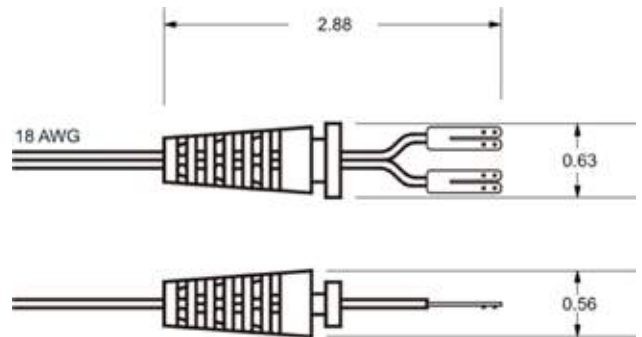

**Low Profile Connector Cap**

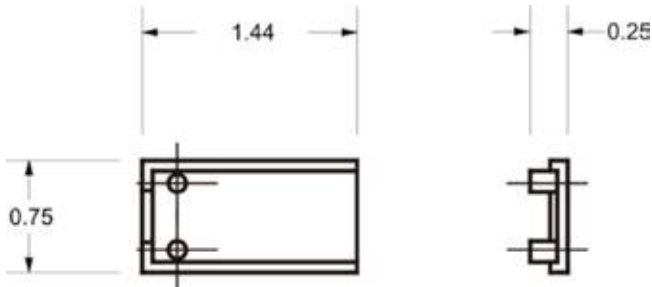

**Low Profile Connector with 3 foot white lead**

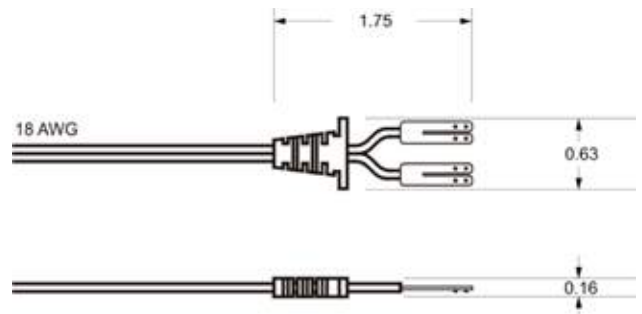

**Small Connector Cap for 0.25"**

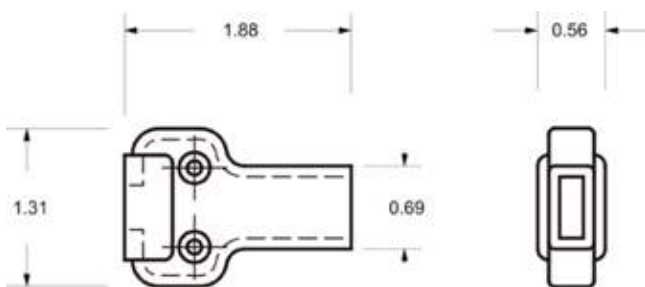

**Standard connector, strain relief, with 6 foot black lead**

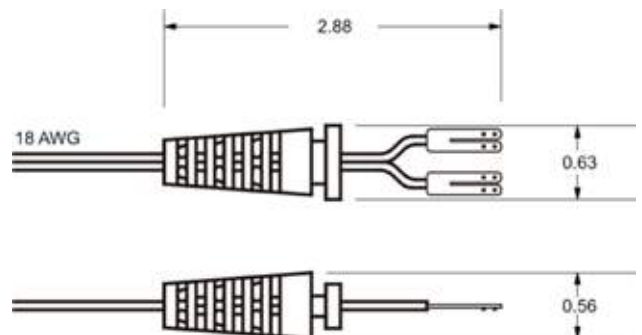





# How to Order

# How to Request a Quote

Please provide the answers to the questions below to expedite the process of preparing a quote. You can reach one of our sales team with questions at +1 804.355.1692.

<b>Contact Information:</b>	Name; Company; Email; Phone; City; Country
<b>Application Type</b>	Backlighting, Interior Accent, Exterior Accent, Event or Trade Show, Out-of-Home, Safety, Other
<b>Indicate location:</b>	Interior or Exterior/wet
<b>Indicate input power source:</b>	(i.e AC or DC)
<b>Indicate the number of zones:</b>	(i.e 3 strips, 2 zones) refer to page C3 and C4
<b>Specified width(s) (Custom widths and shapes are available):</b>	Refer to pages A6 and C5
<b>Specified quantity and length(s):</b>	Please note that every lamp has a connector on one end. The total length of the connection including strain relief will be approximately 5 inches longer than the lit length.
<b>Indicate color preference(s):</b>	Refer to page A8
<b>Provide a top view drawing of your lighting layout indicating dimensions of the Light Tape® and power source locations:</b>	Refer to pages C3 and C4.
<b>Indicate mounting preferences. For adhesive tape or Velcro, indicate if you would like either to be pre-installed prior to arrival for an additional fee:</b>	(i.e Double-sided adhesive, Velcro, extrusion channels) Refer to page D6.
<b>Connector preference:</b>	(i.e Standard or Low Profile and indicate if extended tabs are desired.) Refer to page B5. The standard length from end of panel to beginning of connector is 2 inches.
<b>Describe the purpose of the project and other things we should consider:</b>	(A description of the design concept and photos of the space or of creative inspiration)

# Accent Lighting Example: Top View

## MULTI-POWER SUPPLY INSTALLATION

A top view example of a Light Tape® interior accent lighting installation. Note there are three segments of Light Tape® powered by three individual power supplies. Each power supply is selected based on the total surface area.

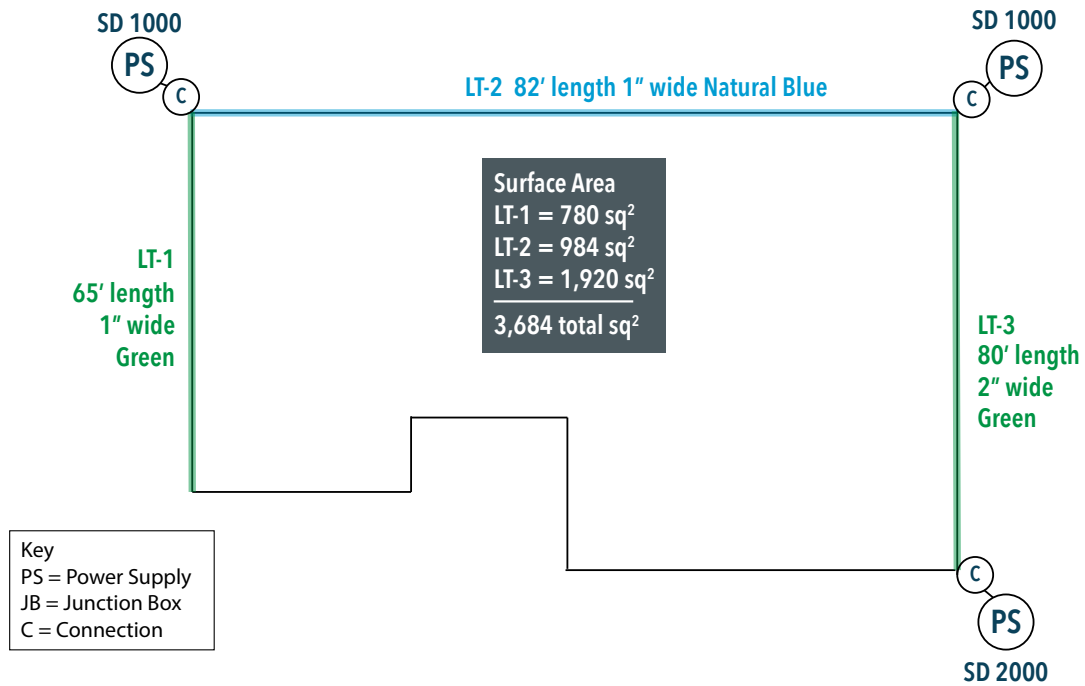

## SINGLE POWER SUPPLY INSTALLATION

Now a top view of the same Light Tape® installation as above. Note there are three segments of Light Tape® powered by *one* individual power supply. The power supply is selected based on the total surface area of the all the segments combined. Each Light Tape® segment is connected via junction box to the same power supply.

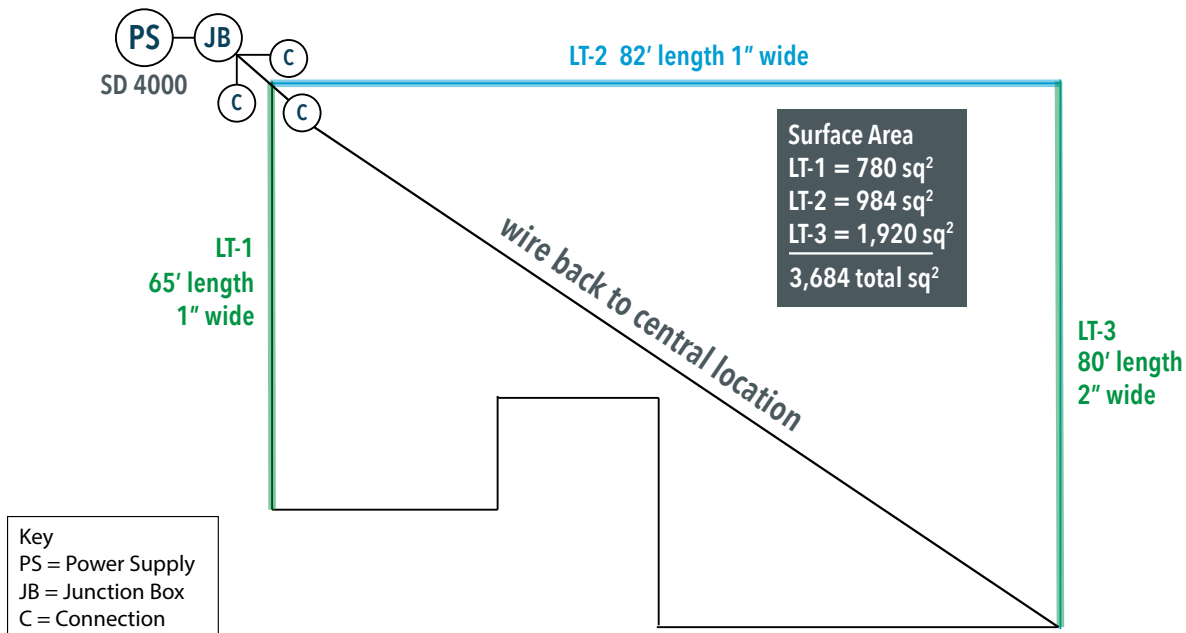

# Backlighting Materials: Top View

## BASIC BAR, COUNTER TOP OR WALL

Any surface area can be evenly illuminated with a minimal number of panels and connections. A bar design resembling the one below would require only two Light Tape® panels and one power supply. The Light Tape® panel is placed directly on surface with double sided adhesive.

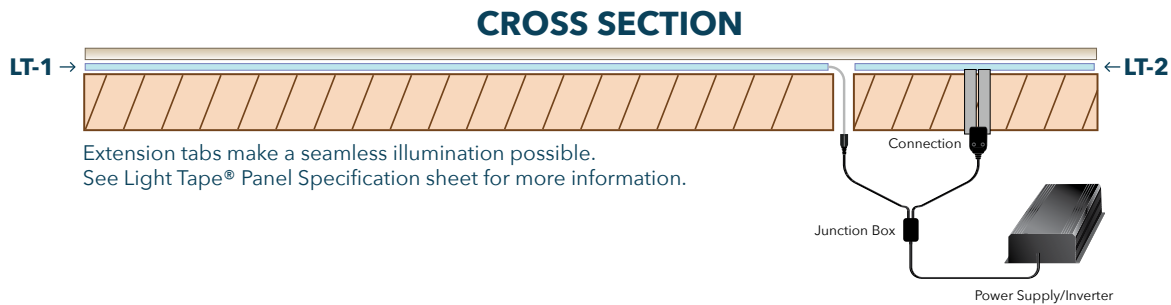
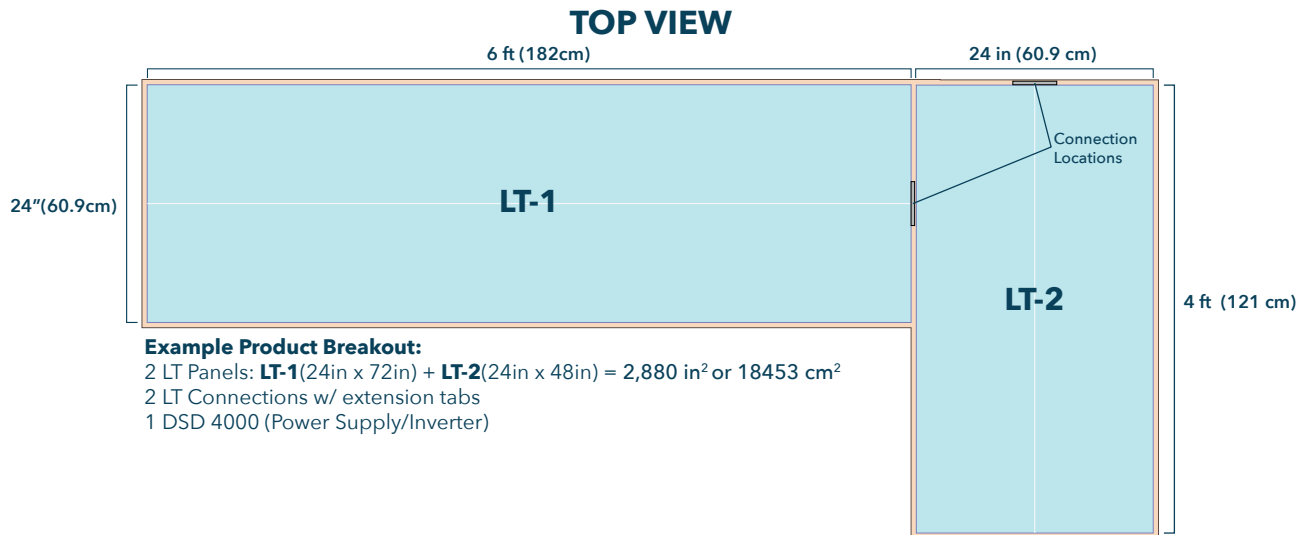

## SURFACE WITH CUT OUTS

Light Tape® panels can be custom cut to any shape and placed side-by-side or overlapping to seamlessly illuminate any surface. For custom shapes, an AI file or template will be needed.

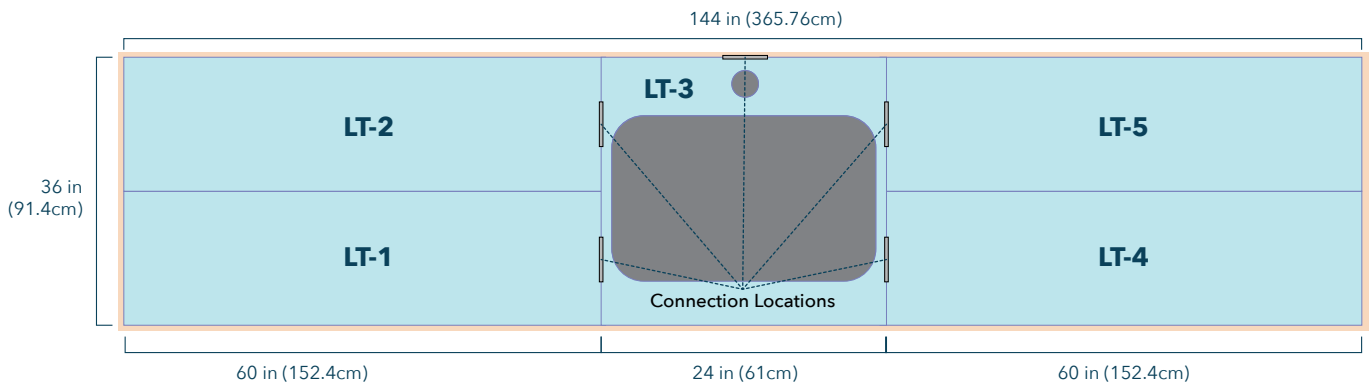

# Backlighting Custom Shapes

Light Tape® can be cut into just about any shape and maintain its even illumination. To ensure even illumination, it is important that both hemispheres of the Light Tape® has equal surface areas. An asymmetrical shape is more challenging to produce, but still possible. Either way, no shape is impossible to illuminate, no matter the size.

## **SYMMETRICAL SHAPES**

If both hemispheres are equal in surface area, Light Tape® will light up evenly. Shapes such as the heart shown at right are very simple to produce because each side of the SEMP (split electrode midpoint) has equal surface area. In many cases, just basic measurements are sufficient to make your shape.

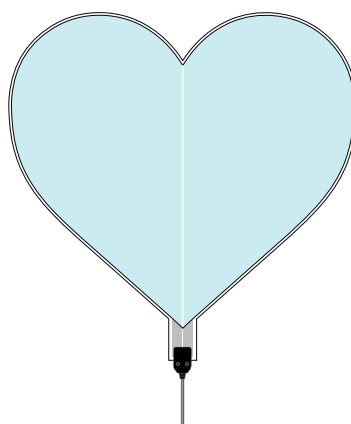

## **ASYMMETRICAL SHAPES**

Determining the SEMP of an asymmetrical shape is a challenge, but is absolutely possible. We require an Adobe Illustrator or PDF file to be submitted with your design. From this file, we can determine the total surface area of your shape and like the Light Tape logo shape above, we can place the midpoint so both hemispheres are equal.

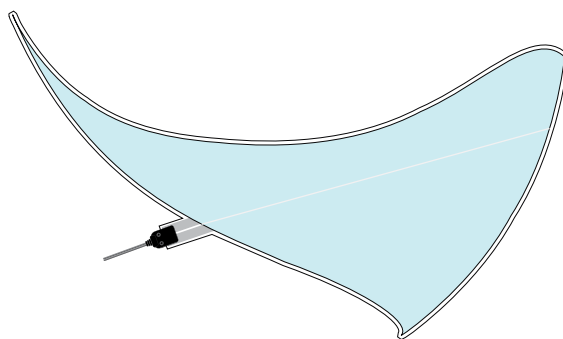

If you do not have an AI file for your shape, it is possible for our team to create one for you for an additional fee. In this case, please provide a template of your shape, and we can do the rest.



# Cutting & Installation

# Light Tape® Safety & Handling

- Never operate Light Tape® when in a coil. Unroll first before powering.
- Always consult local electrical codes for wiring or other specification and regulations.
- Take care to mount the Light Tape® out of reach of children or malicious individuals.
- Always seal Light Tape® lamp, if cut, with Edge Guard™.
- Do not step on Light Tape® during installation.
- Install in dry conditions. Do not cut or expose open ends to moisture.
- Do not break lamination when pulling around sharp edges or corners.
- Do not use a screwdriver or sharp object to force lamp into tight areas.
- Do not fold, twist, rotate or kink lamination excessively.
- Do not stretch, puncture, or crease Light Tape®, as it will destroy conductive layers causing black spots or failure.
- Do not operate lamp outdoors during peak daylight hours due to harmful UV rays.
- Use a photo-cell for outdoor installation, to prevent the Light Tape® from operating in peak daylight hours due to harmful UV rays.
- Light Tape® can be mounted outdoors but should not be operated in direct sunlight. This will shorten the life of the lamp.
- Do not operate Light Tape® without protective lamination.
- Follow all installation guidelines from Electro-LuminX®. If there are any questions, check our website [www.lighttape.com](http://www.lighttape.com).
- Do not thermoform or stretch Light Tape® over objects or bend Light Tape® in a tight radius.
- When cleaning Light Tape® or Smart Drivers™, do not use water or a chemical cleanser.
- Be sure dust doesn't accumulate on driver.
- Do not operate Smart Drivers™ outdoors unless in a NEMA enclosure.
- In industrial applications, use caution when operating Smart Drivers™ as they have not been explosion-proof rated by the National Electrical Code (USA, Central and South America), Canadian Standards Association, International Electrotechnical Commission (ATEX- Europe and outside Americas), and Gosstandart (Russia).
- Do not mount using an epoxy or other exothermic adhesives.

# Indoor Installation Tips

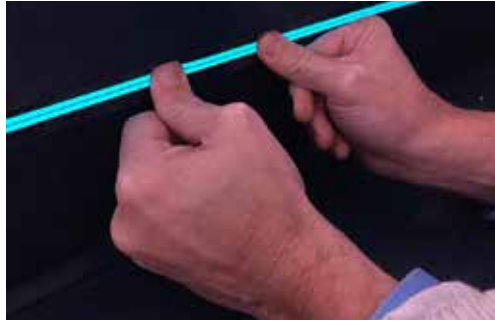

1. Clean surface with isopropyl alcohol to remove all dust, oil and grease. Surface should be smooth and clean for good adhesion.
2. Determine where you will make the electrical connection. It is important to consider the connector and cap lengths. The conductive electrodes can be located behind the Light Tape®. We recommend all electrical connections are made in a junction box. Please follow local code.
3. Mount in a manner that allows the Light Tape® to be easily changed (i.e. wall studs behind sheet rock wall). Do not step on Light Tape® during installation. Avoid hard creases. We recommend using our VibraMount™ adhesive as a backing when indoors. Place adhesive on wall, trim to size if needed, and remove liner.
4. Hide the connector. The conductive electrodes are basically flat wires. Be careful not to rip the surrounding lamination around the lamp; lamination can be cut around the tabs if needed.
5. Be very careful when applying Light Tape®, make sure the coiled lamp is straight before you start to unroll. Once it has been applied, pulling it off with force will damage the lamp.

## Note:

For larger panels, it is easier to unroll the Light Tape® into place. Begin with the connector end, make sure the leading edge is square, and slowly unroll the panel from left to right.

---

## Remote Power Supply Installation

Sometimes, the power supply must be located far from the lamps. In this case, shielded conduit may be required to protect against high frequency and high voltage.

- A NEMA enclosure is required to store power supply when located outdoors. It is made of polycarbonate that is highly resistant to heat and nature's elements. These enclosures can be found at <http://www.automationdirect.com/enclosures>.
- 50 foot connection radius -- it is possible to install the Light Tape® up to 50 feet (15.25m) from the Smart Driver™ power source. Multiple connections are possible from one central location.
- Electrical Metallic Tubing (EMT) conduit is required to shield the high voltage and high frequency AC signals for remote installations. All wiring should be within a conduit and 600 volt rated.
- Always follow all local electrical codes.



# Installing Panels for Backlighting

It is important to remember a few things when installing large panels.

- Light Tape® panels utilized for backlighting are equipped with extension tabs. The tabs are designed to position the electrical connection under the mounting surface.
- Light Tape® panels do not have polarity (+ or -).
- Multiple panels can be powered by a single Smart Driver™ lighting ballast.
- Do not crease or fold Light Tape®, keep out of work area until ready to install
- Plan panel placement before adhering to surface
- In many cases, very little adhesive is necessary to hold light tape in position.

1. To test the backlighting layout, lay the Light Tape® panels on structure that will be illuminated. Adjust the placement of the Light Tape® panels to make sure the entire surface area is covered and there are no seams. It is acceptable for the Light Tape® panels to overlap, if necessary.

2. Once your practice layout is complete, draw an outline of the black connector for each panel onto the base structure to identify where to route an access hole to hide the connectors. Then remove the Light Tape® panels and route the connector access holes.

3. Apply adhesive materials to base surface.

4. Push the connectors and leads through the routed holes and connect all leads in parallel to the Smart Driver™ lighting ballast. The Light Tape® panels utilized for backlighting are equipped with extension tabs.

5. Peel off the other side of the foam adhesive.

6. Making sure to replicate practice layout, begin to mount the Light Tape® panels. Starting with connector end, slowly unroll panel in a straight path to avoid bumps or ridges.

7. Once first panel is in place continue placing panels one by one until surface is covered.

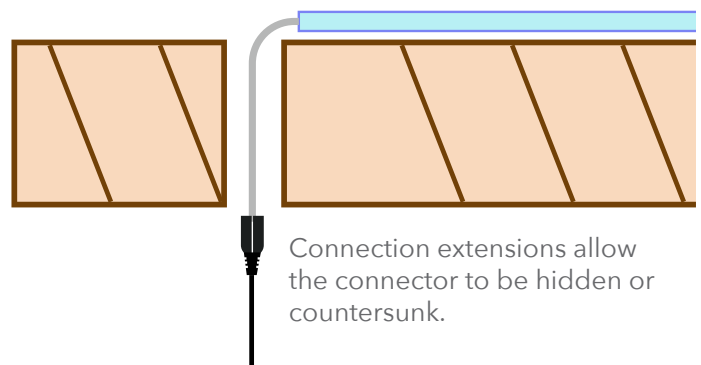
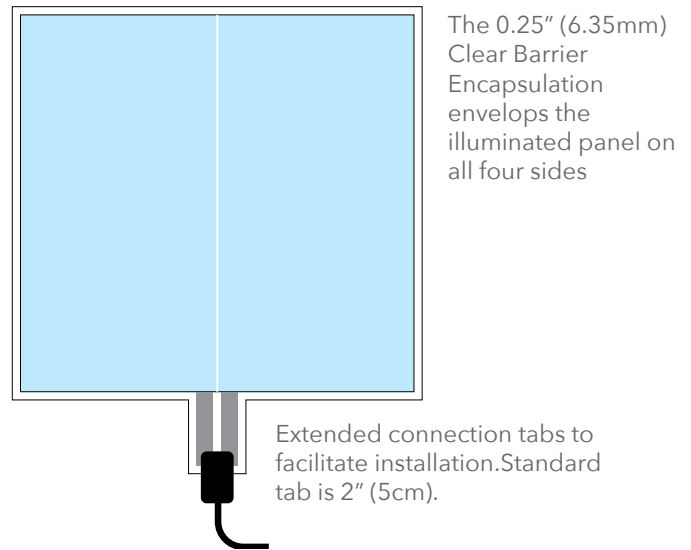

# Floor Installation

Light Tape® lamps have tremendous impact resistance which makes them difficult to damage. Weight is not an issue, but it is important to protect Light Tape® from abrasion, puncture, and sharp objects which can damage the barrier lamination. However, there are several simple methods one can use to install Light Tape® for years of service.

## PERMANENT FLUSH MOUNT 1 year + install duration

Flush mounting for a seamless integration. A channel is cut into the surface to hold the Light Tape® lamp and protective lens. The protective cover can be made of glass or plastic such as polycarbonate and is placed on top of the Light Tape®. The channel holding the Light Tape® should be smooth and free of debris, a Vibramount insulating adhesive can be added if not.

For exterior or wet applications, we recommend sealing around the edge of the channel to prevent moisture from entering. Factory sealed exterior lamination and exterior connections are required to protect the Light Tape®. A drain may be required to remove standing water.

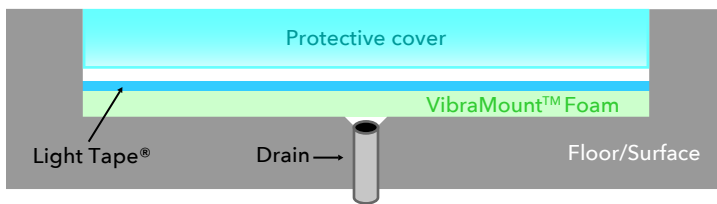

## SHORT TERM INSTALLTION Less than 1 year install duration

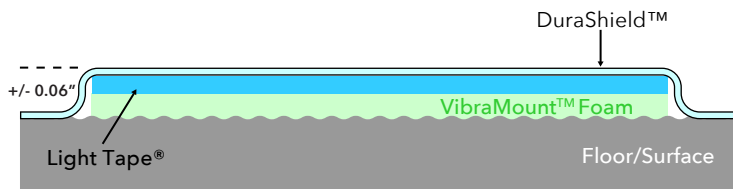

For **Rough Surfaces** use Vibramount Foam double-sided adhesive between floor and back of lamp

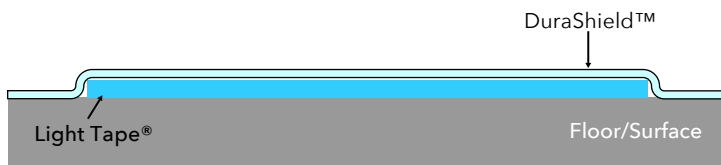

For **Smooth Surfaces** Light Tape® can be applied directly to the floor surface, and covered with with DuraShield adhesive tape.

When installing Light Tape® and adhesive tape, it is critical that the mounting surface is cleaned according to these guidelines to get good adhesion. Failure to fully comply with these directions will result in poor adhesion to the mounting surface.

- Surface should be clean and dry and free from any loose dirt and dust.
- If attaching to a hard surface, a quick cleaning with a 50/50 mixture of water and Isopropyl Alcohol (90% concentration) in a spray bottle, will remove any loose surface dust and oily residue from the surface.
- Cleaners such as Windex, Formula 409, denatured alcohol, lacquer thinner and other solvents should not be used as they will leave an invisible film behind that will prevent the adhesive from properly bonding to the surface.

# Mounting Materials

## ADHESIVES

**Light Tape® Edge Guard™:** A moisture resistant clear tape for interior applications for protective sealing against electric shock.

**Light Tape® VibraMount™:** Designed to easily secure Light Tape® panels to almost any surface while eliminating vibration, VibraMount™ is a double sided adhesive foam core material available in tileable panels.

**Durashield 511 overlay series:** A 3M 4195C/ EZ Polyethylene Protective Tape is perfect for exhibitions, museums and temporary events. It protects Light Tape® from side scuffing, abrasion and impact while on temporary installations of a few weeks

**Durashield 471** (3M 471 for floor marking) is designed for more heavy duty industrial or permanent applications, such as factory floors. Both materials were developed by 3M to deliver the perfect Light Tape® adhesion and barrier for floor applications.

**VHB:** Designed to secure Light Tape® strips to almost any surface while eliminating vibration, VHB is a double sided adhesive foam core tape. Clear core is available in 0.5" and 1", and black core 60 mil (1/16" / 1.6 mm) is available in widths up to 24" for large panel installations. Also, it provides impact resistance on uneven surfaces.

## PROTECTIVE SEALANTS

**3M DP-100+ epoxy:** A two part epoxy system offering fast cure and machinability. It is easily mixed and meets UL 94. Perfect potting compound for outdoor connections.

**Light Tape® shrink tube:** A heat-forming tube used in conjunction with our outdoor Snap-N-Light™ mounting system to form a moisture barrier and secure connector to channel.



# Installing Corners or Bends

## CREATE A CURVE

Form Light Tape® into a soft bend.  
Do not flatten to create hard bend.

## INDOOR

Light Tape® should gently curve around bends and never be creased into a corner. Creating a bend or hard fold will damage the conductive coatings, leading to lamp failure.

## OUTDOOR

DO NOT bend Light Tape® around corners. Light Tape® is subject to expansion and contraction. Please reconnect per outdoor connection procedure. Hard bends create pinch points, impeding movement.

## BEND RADIUS

The bend radius recommended for a lateral curve is 30% of the length of the curve. Light Tape® is to lay flat on the surface for the entire run. See illustration on the left below.

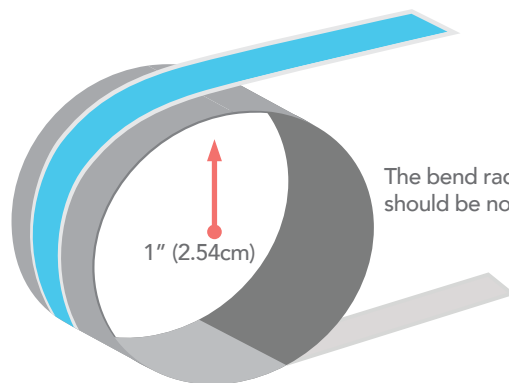
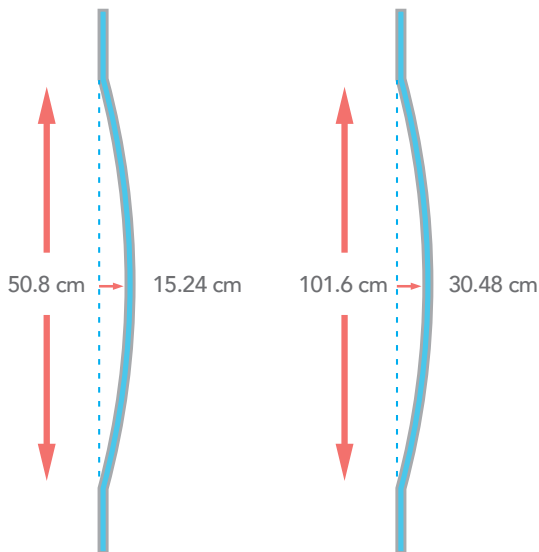
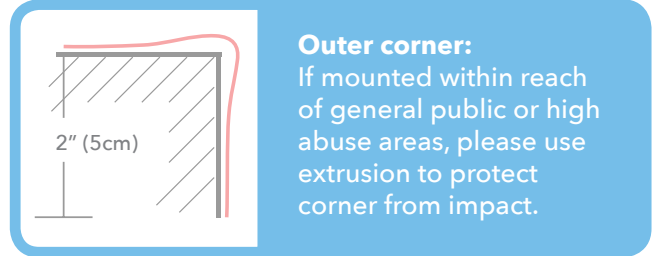
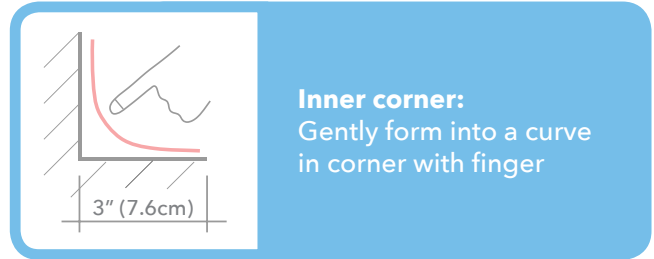

Each bend radius figure based on 2" (5.08cm) Light Tape® test standard. The thinner the width, the greater the bend.

# Sealing & Cutting Light Tape®

Light Tape® should always be completely sealed. Our factory barrier seal protects the lamp against moisture and acts as an insulator. If the factory barrier lamination is cut, it must be resealed using Edge Guard™ tape.

## NOTE FOR OUTDOOR APPLICATIONS:

Field seals are appropriate for most interior applications, but factory seals are required for outdoor, floor, and wet locations.

## MATERIALS:

- a. Light Tape®
- b. scissors
- c. Edge Guard™ end seal tape
- d. square (for large panels)

1. Make sure Light Tape® is disconnected from power supply. Place lamp under square at desired length for large panels. For smaller widths, simply mark where to cut.
2. Cut carefully across strip to ensure a straight and square end.
3. On the cut end, place enough Edge Guard™ to overhang the edges and to evenly fold over on both sides of the lamp. Fold and press to ensure no bubbles form under the Edge Guard™ tape and trim excess from the sides. If both ends of the lamp are cut, make sure the Edge Guard™ tape is applied to both ends.



# Making a Connection

The entire rear electrode of Light Tape® is conductive allowing a connection to be easily made.

## MATERIALS:

- a. Light Tape® lamp
- b. large connector wire w/ piercing pins "nics"
- c. needle nose pliers
- d. large connector caps with screws and butyl
- e. clamps/vice grip
- f. power supply
- g. drill/screwdriver

1. Hold nic (piercing pin) flush to the silver side of the lamp, one on each side of the split electrode midpoint. The pointed barbs on the nics should be facing the silver side of the tape.
2. Crimp the nics one at a time into the non-illuminating silver side of the lamp using flat head pliers. Make sure each nic is isolated on either side of split electrode midpoint (SEMP). Apply pressure to pliers until nics are secure and cannot be pulled out easily.
3. Using the power supply, test the connection to ensure it has been properly made.

\*Do not touch the nics and exposed wires to avoid electrical shock.

4. Peel off paper backing from the butyl caps. There is a front and a back cap. Place the cap without threaded holes on the colored side of the lamp and the cap with threaded holes on the silver side. Screw the caps together and use clamps/vice grip to press connector into sealed position.

**Note for Outdoor Applications:** Butyl Caps are filled with weatherproof epoxy completely protecting connection from elements



# Connecting Multiple Light Tape® Segments

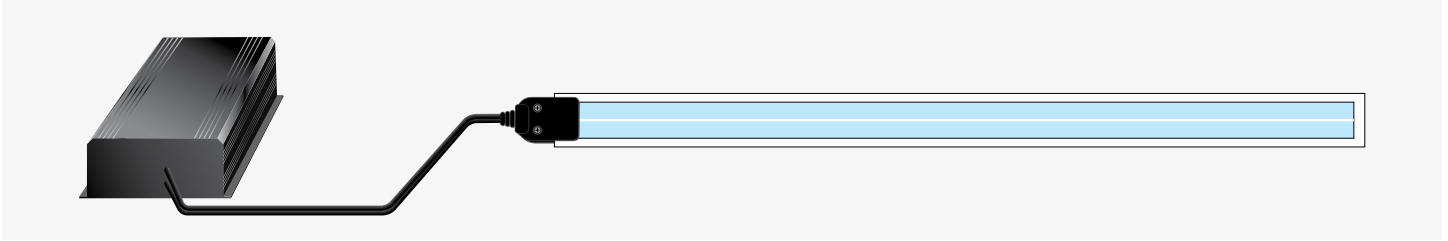

Only one connection is required to power Light Tape® and there is no polarity. Terminating the other end is not necessary. Please see connection guide or our website's online video for "How-To" instructions. It is possible to operate one lamp or multiple lamps with only one power supply. See ballast information before starting to determine the appropriate power supply based on your installation.

## PARALLEL CONNECTING

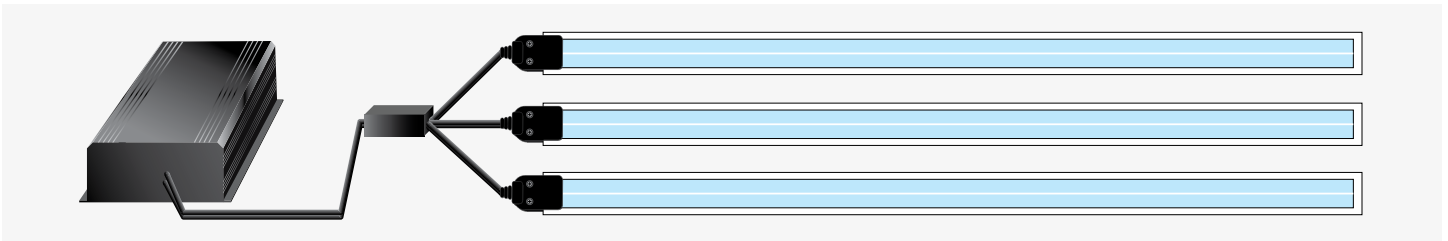

Connecting lamps in parallel is the preferred method. Make all connections per local electrical codes. For remote locations and long runs, please use EMT conduit to shield AC signal.

**DO NOT** connect Light Tape® in a series or "daisy chain."

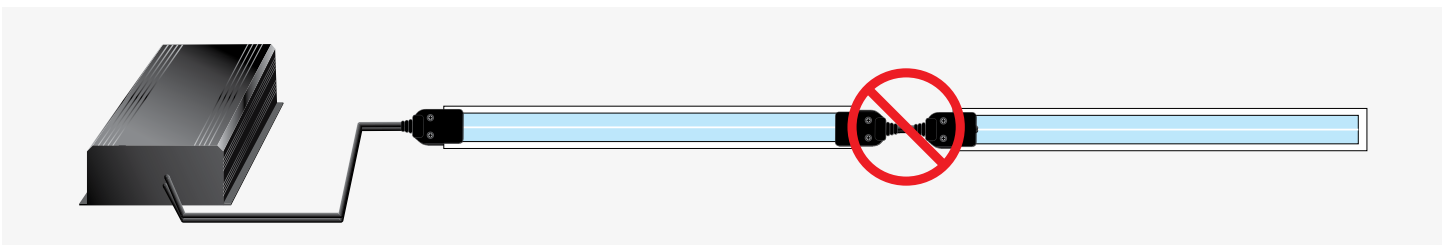

## MAXIMUM DISTANCE PER RUN WITH ONE CONNECTION

Light Tape® is capable of operating over great distances without any loss of light. The following chart outlines recommended single run footages with standard connectors. However, longer runs are available upon request with the addition of conductive foil tabs to the rear of Light Tape® before factory encapsulation.

Imperial	Width	0.25"	0.5"	1"	1.5"	2"	3"	4"	6"
	Feet		100 ft	125 ft	125 ft	150 ft	150 ft	100 ft	50 ft
Metric	Width	6.4mm	12.7mm	25mm	38mm	51mm	76mm	101mm	152mm
	Feet		30.5m	38.1m	38.1m	45.7m	45.7m	30.5m	15.2m

# Snap-N-Light™

## Mounting Channel Installation

Our engineered mounting channels are designed to protect Light Tape® from tampering and the outdoor environment. Constructed from high grade polycarbonate, they have tremendous impact resistance and weatherability. The system is either installed using clips or adhesive depending on building surface. In order for our system to work for years, it is important that Light Tape® is mounted properly. All outdoor installations **MUST** be mounted using our mounting channels to allow the Light Tape® to expand and contract due to changes in the weather. Any Light Tape® used in outdoor installations without mounting channels will void warranty.

### A few simple rules and suggestions for the proper installation:

- **DO NOT** bend mounting channel around corners when mounted outdoors. A sharp bend of the mounting channel will pinch the Light Tape® inside causing delamination and lamp failure.
- All segments should be sealed per Electro-LuminX's procedure. We recommend factory seals for all outdoor installations.
- Be sure to specify connection end - left or right side - so the channel is pointing in the correct direction. This will ensure the drainage slot is on the bottom.
- The connector will extend about 4.5" (11.4 cm) beyond the lit portion of the lamp on the end.
- Please follow local electrical codes, all connections should be in a junction box.
- For outdoor applications, Light Tape® should be controlled using a timer to prevent daytime operation. Operation in direct sunlight leads to over excitation of the phosphors.

## Follow the below step-by-step outdoor mounting instructions to ensure that Light Tape® is installed properly.

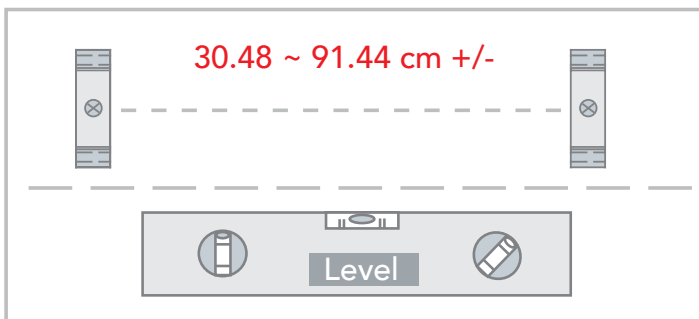

We recommend using a flat seat screw such as the pan head below. Angle seated screws such as the flat head can cause damage (cracking) to the mounting clips.



1. Clean the surface and mark a chalk line using a level. Mount clips on 12" (30.5 cm) centers, depending on surface, with #10 screws. Mount with the first clip 1" (2.54 cm) from the connector end of the extrusion. If mounting indoors on smooth surfaces, mount UltraBond adhesive foam tape along the level line instead of clips.
2. If your extrusion has a drain slot make sure it is located at the bottom to allow for drainage. **DO NOT** fill open ends of the extrusion with silicone. If mounting with an adhesive do not block bottom gap.



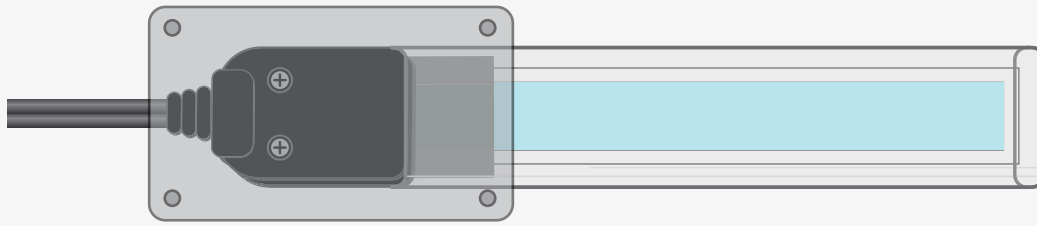

3. Place connection in junction box and always follow local electrical codes.

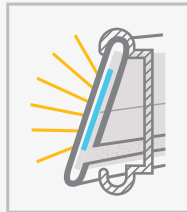

Slide into the top end of the clip first.

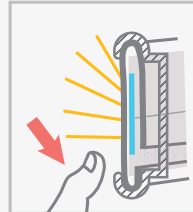

Press firmly downward to snap in place, making sure that slit in back is not covered to allow for drainage.

4. Starting with the connected end, snap the Mounting Channel into the clips (for open channel extrusion: slot on bottom rear). Be careful not to bend or kink the Light Tape® when snapping into place. Be sure that the end of extrusion or bottom rear slit (if using open channel extrusion) are not covered or sealed, especially when using UltraBond™ to mount. This allows for proper air flow and drainage.

**\*See demonstration video online for help if necessary. Please follow local electrical codes making electrical connections and always use the Light Tape® Outdoor Connection Kit.**

# Vertical Mount

For vertical installations, always have connector on the top with drainage slot in the extrusion facing the mounting surface. To prevent the extrusion channel from sliding through the mounting clips, VibraMount™ should be used to attach the connector and the top 5 feet (1.5 m) of the mounting channel to the mounting surface.

## NOTE:

The connector should always be firmly secured to the wall so the extrusion does not slide through the clips. Clean the surface and mark a chalk line using a level. Mount clips on 12" (30.5 cm) centers, depending on surface, with outdoor rated #10 screws. Mount with the first clip 1" (2.54 cm) from the connector end of the extrusion.

Place connection in junction box if required by local codes. Make sure the connector and power supply is located at the top and the channel opening is at the bottom so the extrusion is allowed to drain. To ensure the mounting channel stays in place, use either VibraMount™ or attach an extra support to the top of the connector fixing it to the surface.

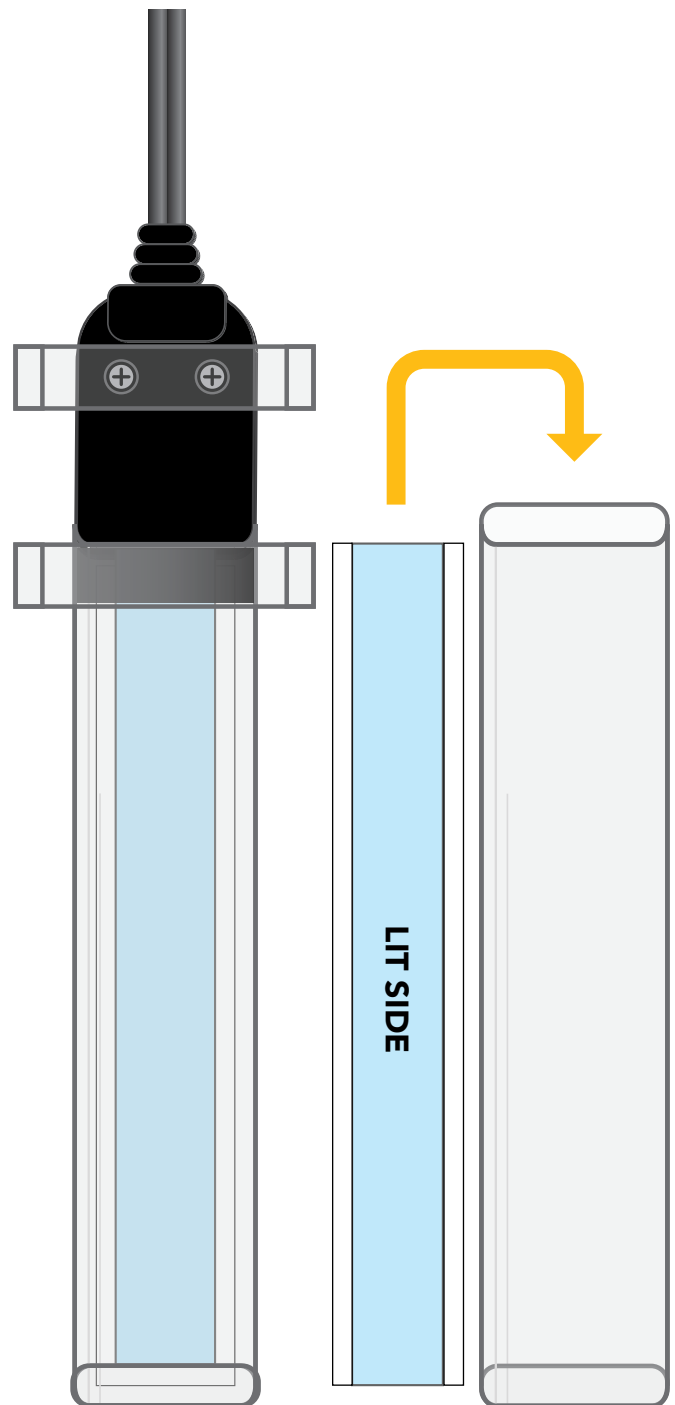

Important to leave open  for air flow

# Snap-N-Light™ Length

## 1" (2.54 cm) WIDE LIGHT TAPE® SNAP-N-LIGHT™ SYSTEM

Please allow an additional 5.5" (14 cm) when determining the dimensions of your Light Tape's Snap-N-Light™ system. This 5.5" (14 cm) accounts for 4.5 (11.43cm) inches for the Light Tape® Connector and strain relief, 1/2" (1.27cm) for wire flex, and 1/2" (1.27cm) for the area between the end of the lit area and the end of the extrusion.

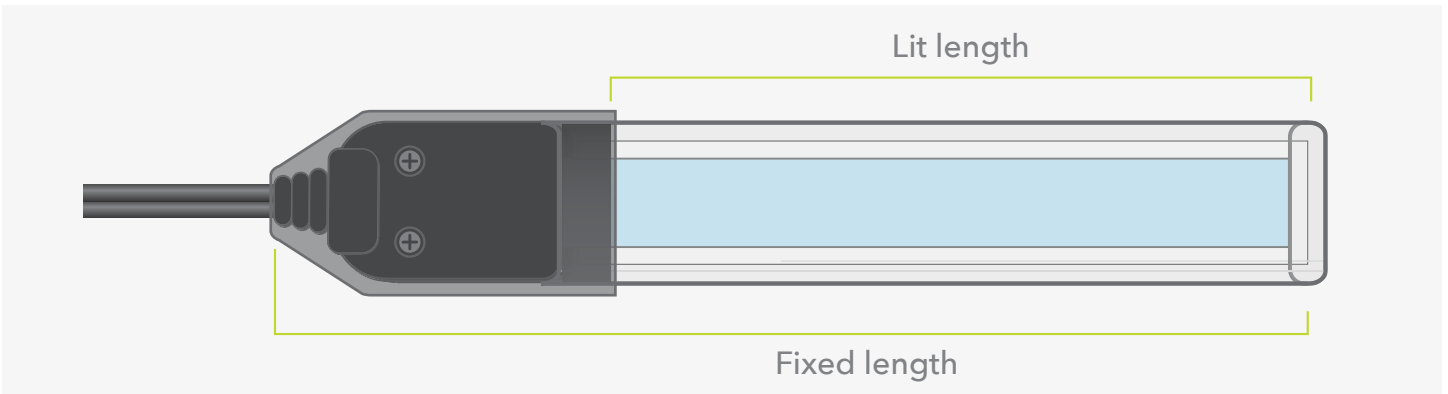

## 2" (5.08 cm) & 4" (10.16 cm) WIDE LIGHT TAPE® SNAP-N-LIGHT™ SYSTEM

The 2" & 4" wide Light Tape® Snap-N-Light™ system employs two connection points for optimal performance. Please allow an additional 5.5" (14 cm) when determining the dimensions of your Light Tape's Snap-N-Light™ system. This 5.5" (14 cm) accounts for 4.5 (11.43cm) inches for the Light Tape® Connector and strain relief, 1/2" (1.27cm) for wire flex, and 1/2" (1.27cm) for the area between the end of the lit area and the end of the extrusion.

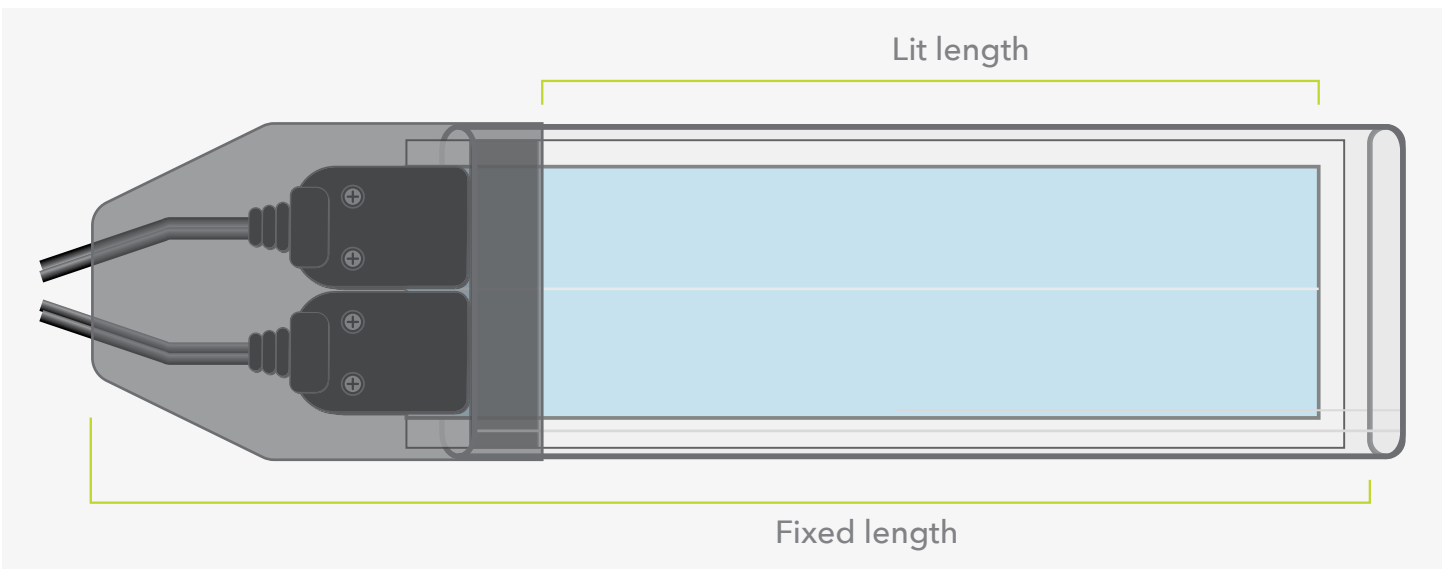



# Color Tech

# Classic Electric Blue Technical Data

Parameter	Value
CCT	10837 K
CRI	88
CRI(Re)	87
CQS	88
Illuminance	175 lux
Foot Candle	16.3 fc
CIE1931 x	0.2725
CIE1931 y	0.2902
CIE1976 u'	0.1835
CIE1976 v'	0.4399
$\lambda_p$	488 nm
$\Delta D$	482 nm
Purity	24 %
Duv	0.0061
S/P ratio	3.1

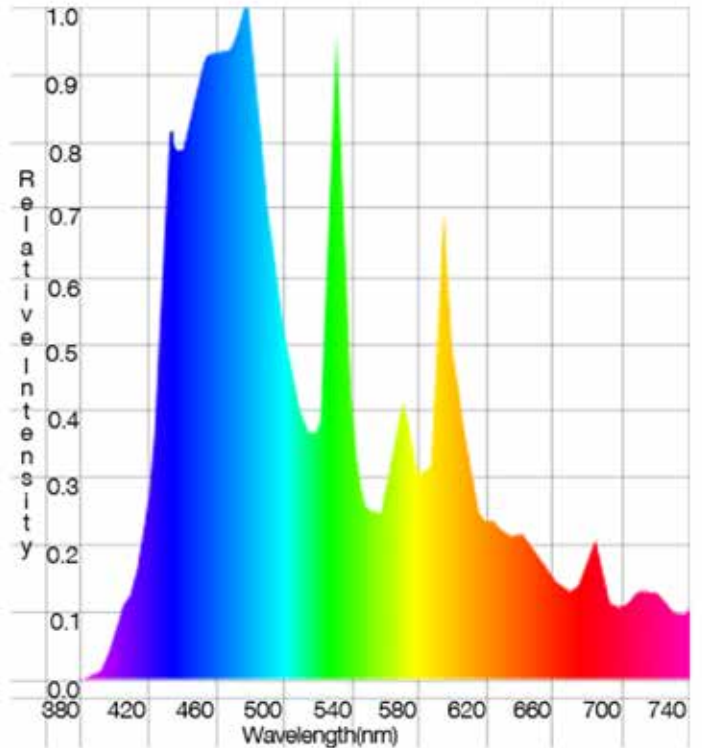
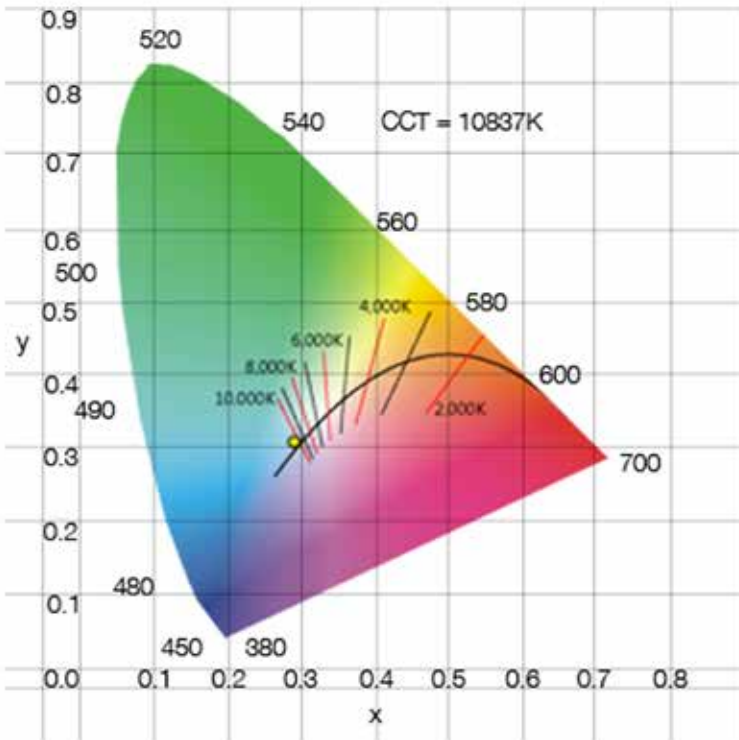

# Extreme Caribbean Blue Technical Data

Parameter	Value
CCT	6500 K
CRI	0
CRI(Re)	0
CQS	0
Illuminance	114 lux
Foot Candle	10.6 fc
CIE1931 x	0.1154
CIE1931 y	0.2578
CIE1976 u'	0.0787
CIE1976 v'	0.3957
$\lambda_p$	486 nm
$\lambda_D$	487 nm
Purity	79 %
Duv	0.0000
S/P ratio	6.6

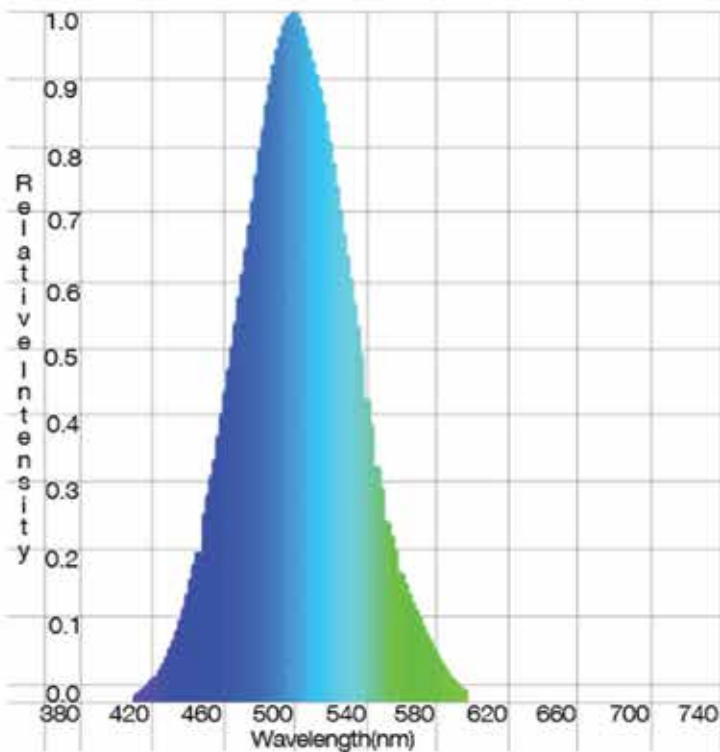
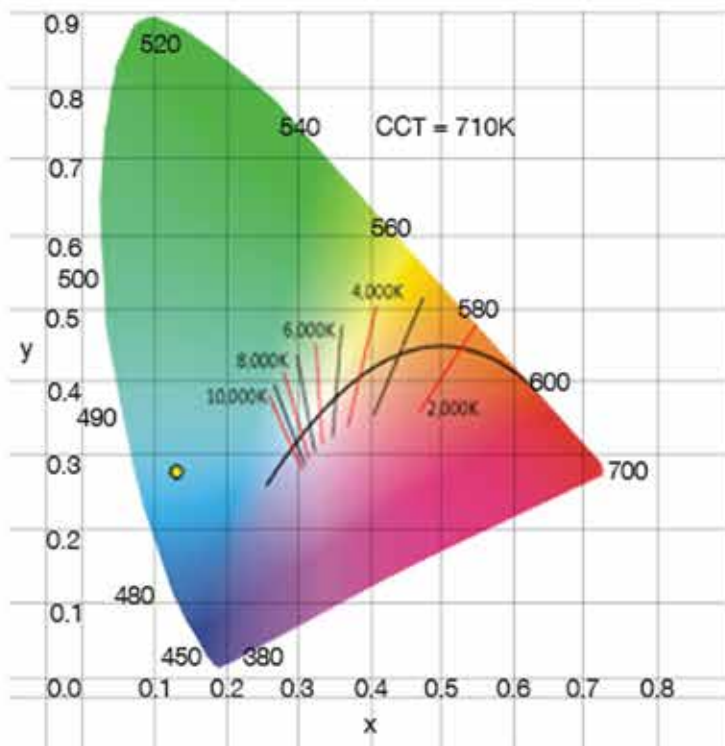
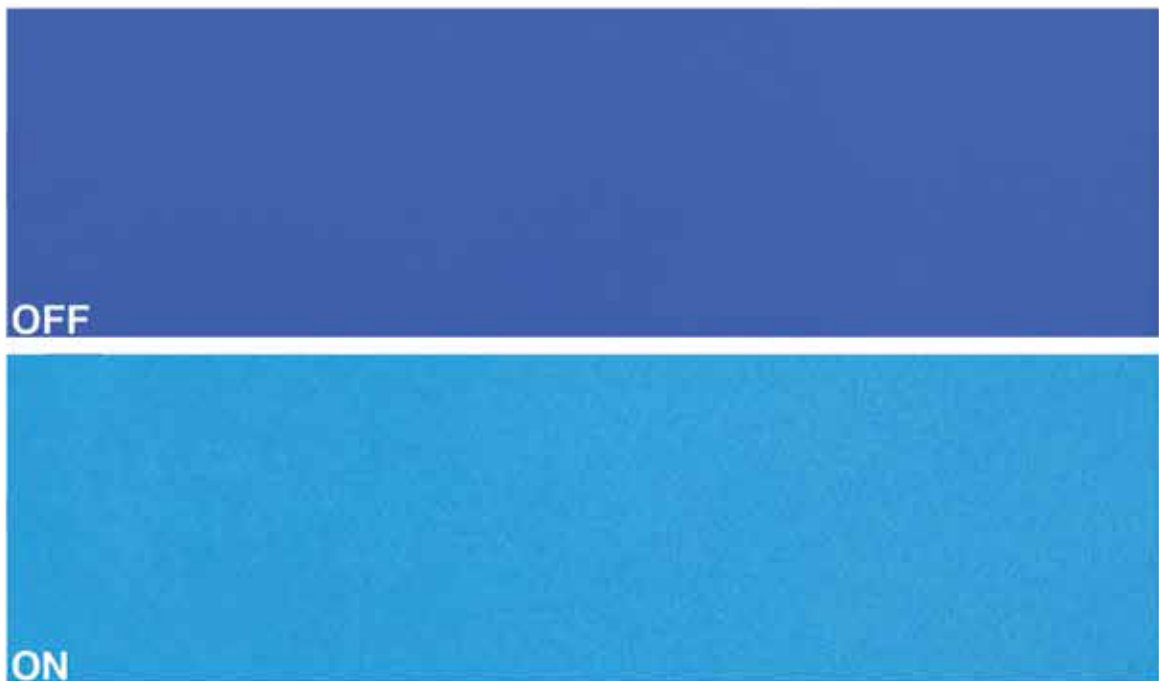

# Classic Media White Technical Data

Parameter	Value
CCT	8,000K
CRI	90
CRI(Re)	86
CQS	89
Illuminance	295 lux
Foot Candle	27.4 fc
CIE1931 x	0.3550
CIE1931 y	0.3689
CIE1976 u'	0.2114
CIE1976 v'	0.4943
$\lambda_p$	547 nm
$\lambda_D$	572 nm
Purity	17 %
Duv	0.0047
S/P ratio	2.0

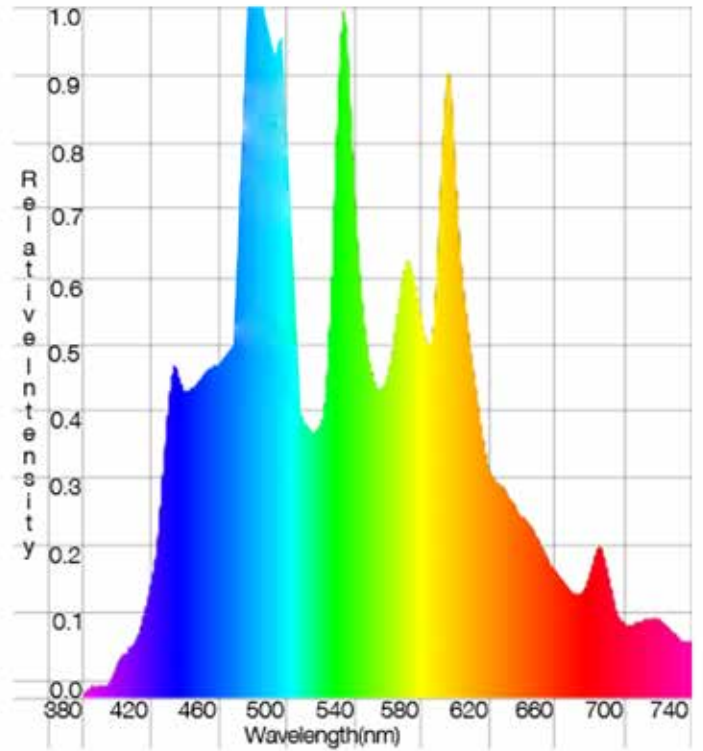
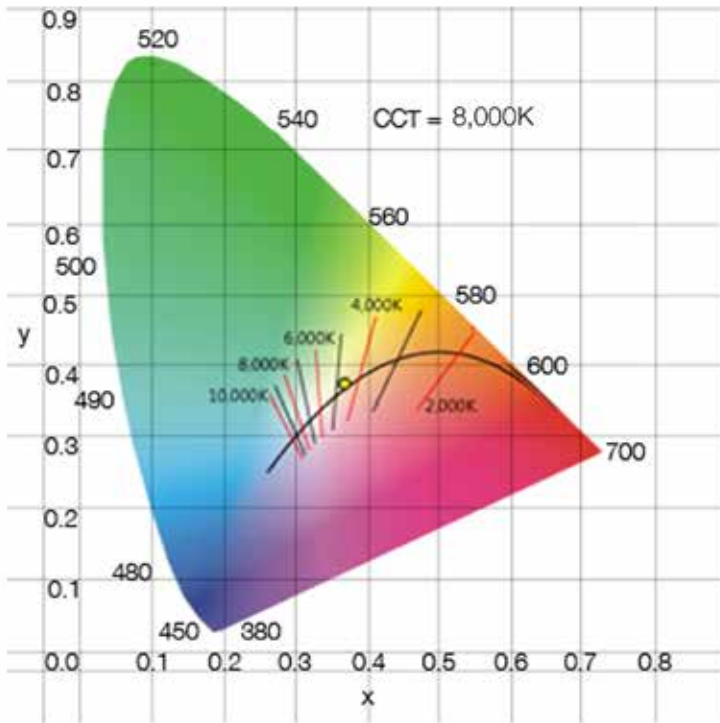
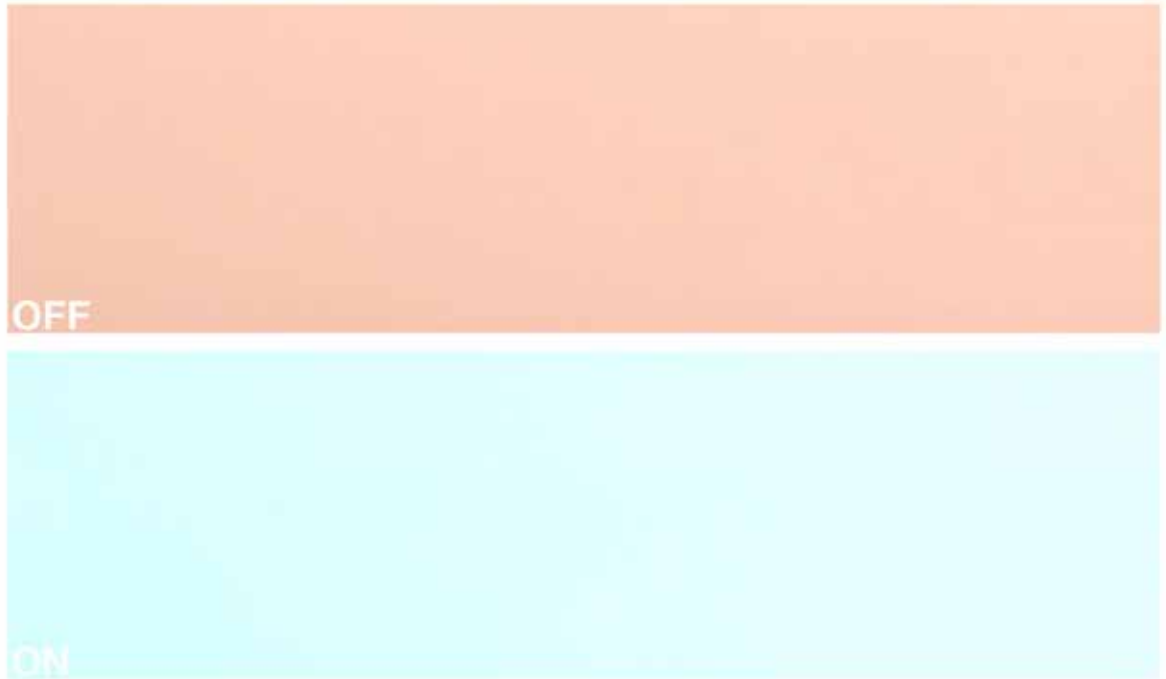

# Classic Yellow Technical Data

Parameter	Value
CCT	4381K
CRI	74
CRI(Re)	63
CQS	74
Illuminance	335 lux
Foot Candle	31.1fc
CIE1931 x	0.4170
CIE1931 y	0.4650
CIE1976 u'	0.2153
CIE1976 v'	0.5403
$\lambda_p$	547 nm
$\lambda_D$	573 nm
Purity	65 %
Duv	0.0269
S/P ratio	1.4

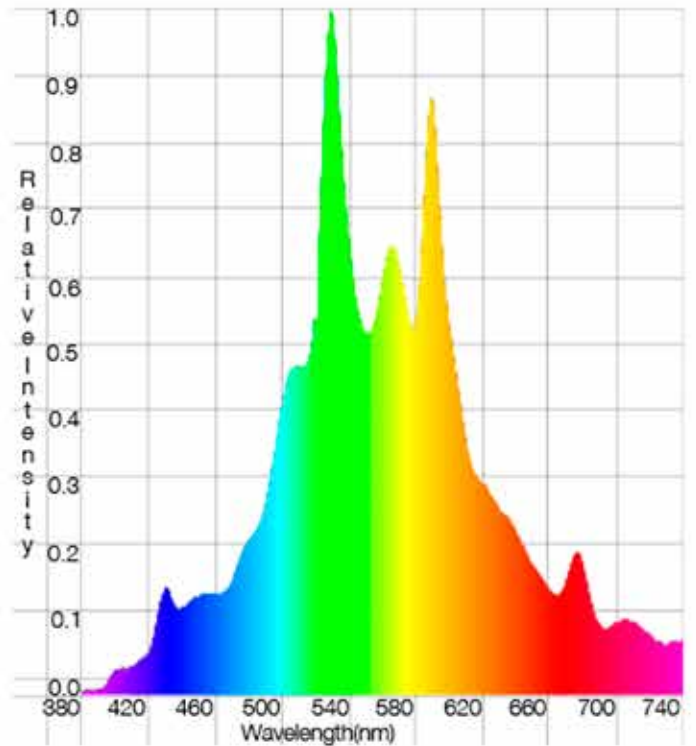
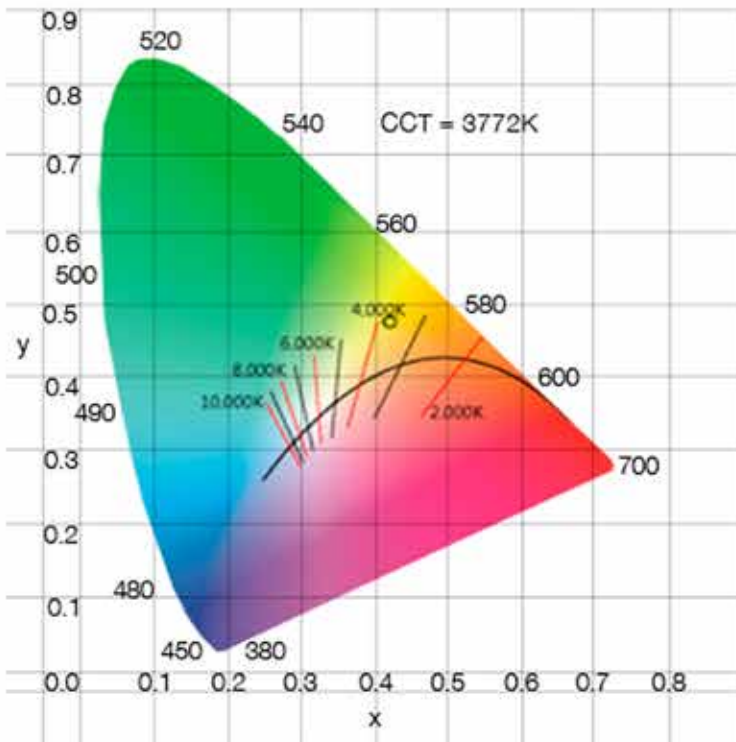



# Extreme Blue-Green Technical Data

Parameter	Value
CCT	6570 K
CRI	74
CRI(Re)	66
CQS	74
Illuminance	354 lux
Foot Candle	32.9 fc
CIE1931 x	0.2986
CIE1931 y	0.4163
CIE1976 u'	0.1614
CIE1976 v'	0.5064
$\lambda_p$	545 nm
$\lambda_D$	527 nm
Purity	17 %
Duv	0.0476
S/P ratio	2.6

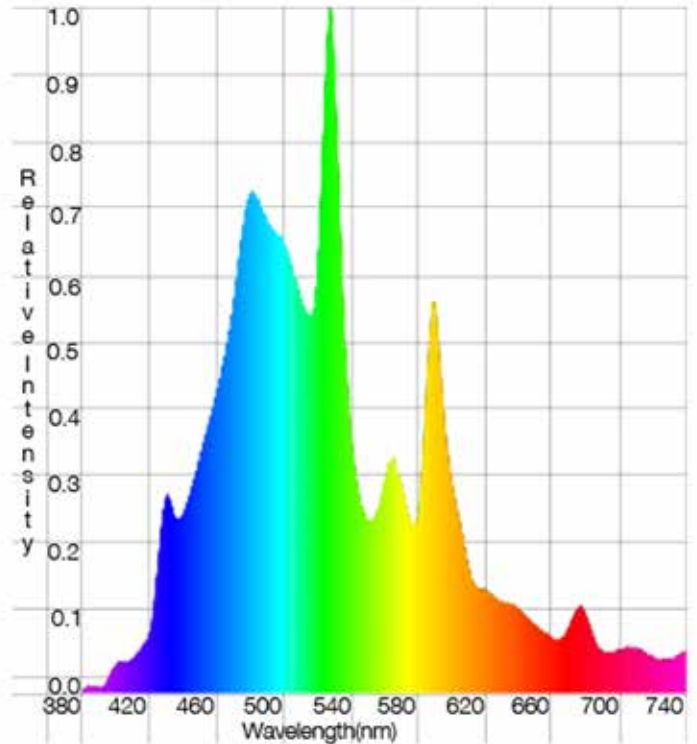
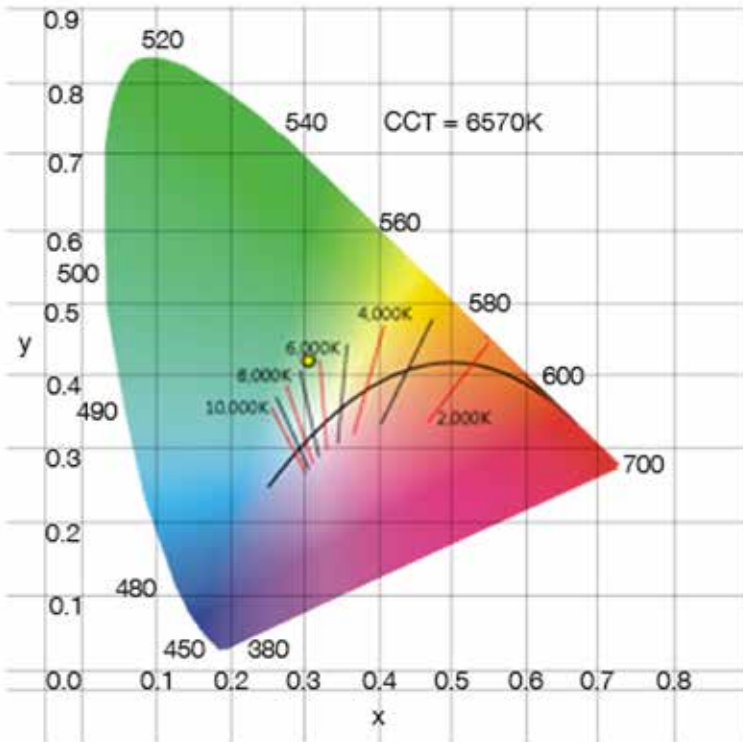

# Extreme Green Technical Data

Parameter	Value
CCT	5601 K
CRI	0
CRI(Re)	0
CQS	63
Illuminance	262 lux
Foot Candle	24.4 fc
CIE1931 x	0.3289
CIE1931 y	0.5037
CIE1976 u'	0.1569
CIE1976 v'	0.5405
$\lambda_p$	545 nm
$\lambda_D$	553 nm
Purity	50 %
Duv	0.0653
S/P ratio	2.1

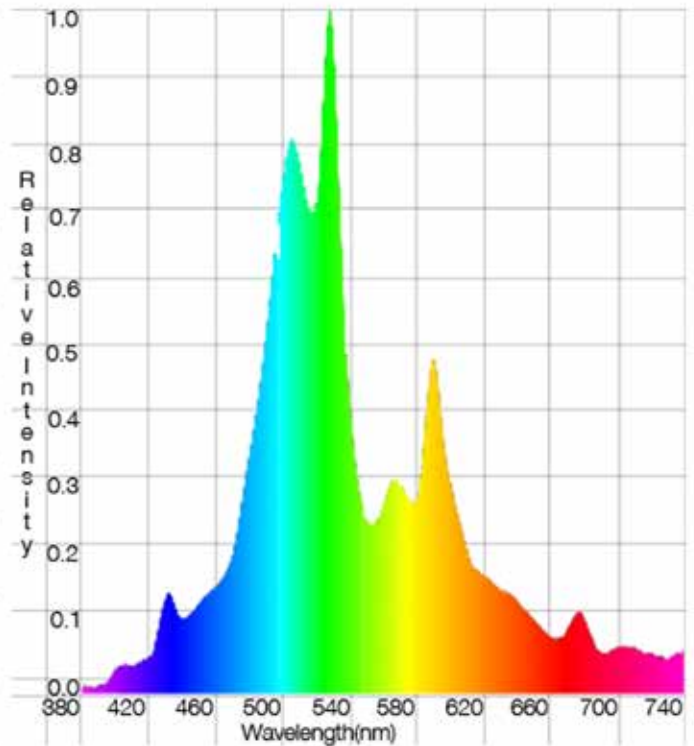
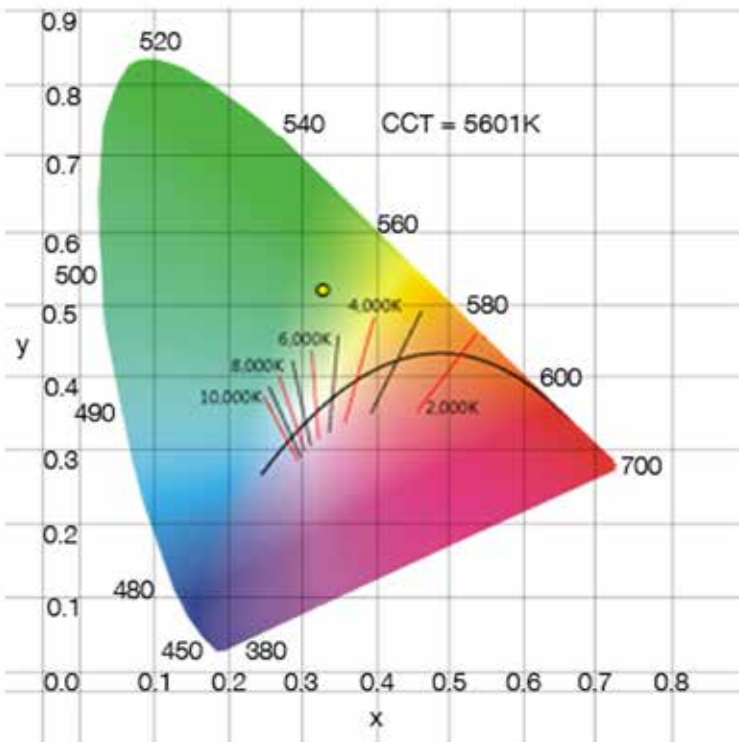

# Extreme International Red Technical Data

Parameter	Value
CCT	1706 K
CRI	75
CRI(Re)	70
CQS	0
Illuminance	197 lux
Foot Candle	18.3 fc
CIE1931 x	0.5243
CIE1931 y	0.3621
CIE1976 u'	0.3330
CIE1976 v'	0.5176
$\lambda_p$	614 nm
$\lambda_D$	599 nm
Purity	66 %
Duv	-0.0154
S/P ratio	1.0

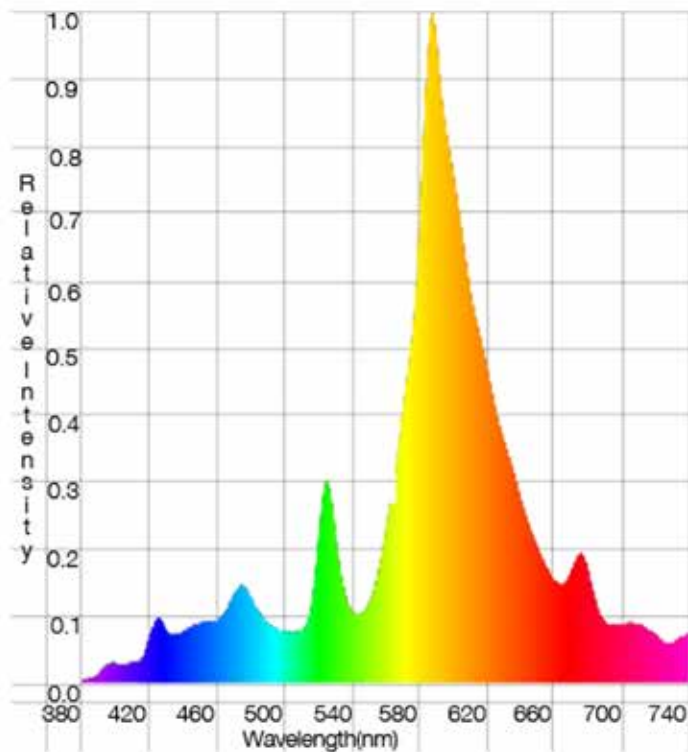
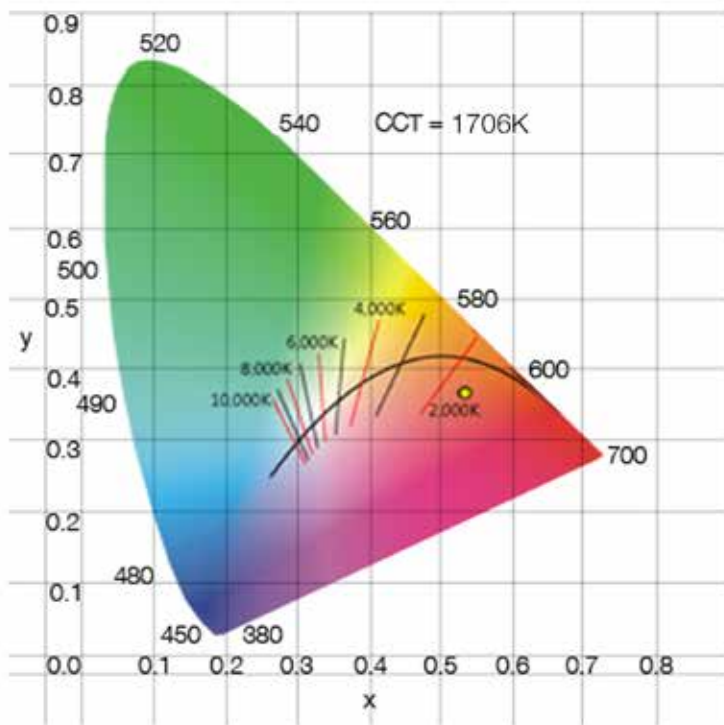

# Extreme Rich Red Technical Data

Parameter	Value
CCT	2225 K
CRI	82
CRI(Re)	80
CQS	89
Illuminance	165 lux
Foot Candle	15.3 fc
CIE1931 x	0.4902
CIE1931 y	0.3965
CIE1976 u'	0.2893
CIE1976 v'	0.5265
$\lambda_p$	615 nm
$\lambda_D$	589 nm
Purity	66 %
Duv	-0.0062
S/P ratio	1.2

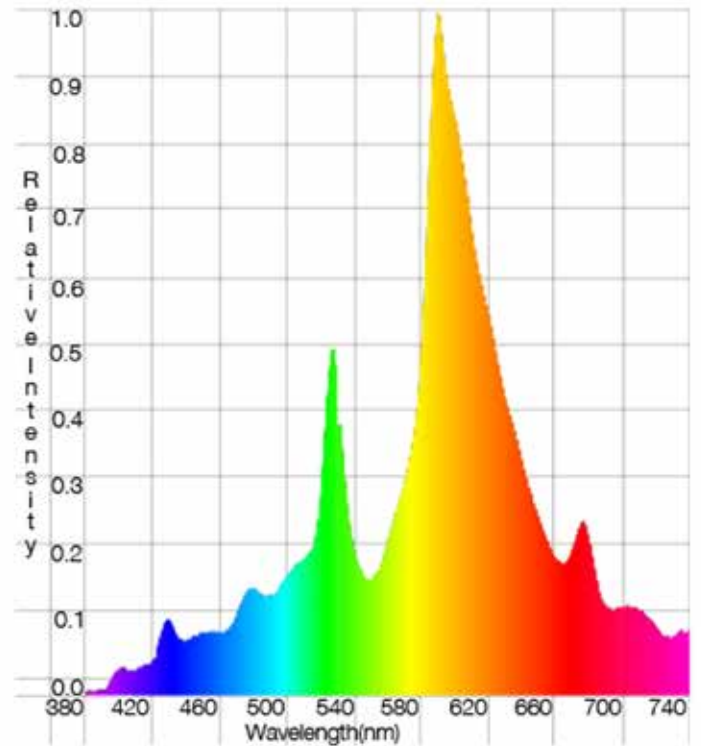
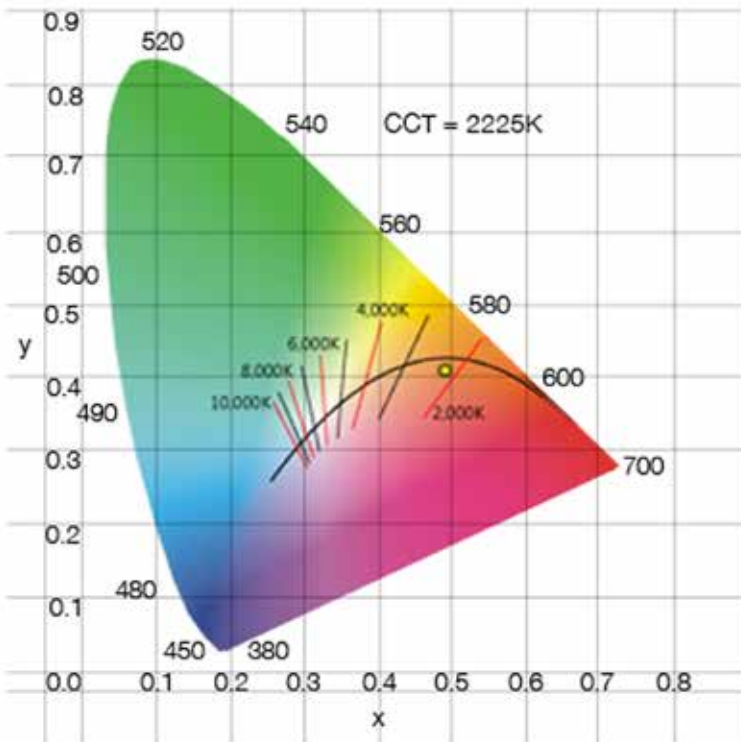

# Classic Natural Blue Technical Data

Parameter	Value
CCT	9537 K
CRI	83
CRI(Re)	79
CQS	82
Illuminance	280 lux
Foot Candle	26.0 fc
CIE1931 x	0.2654
CIE1931 y	0.3293
CIE1976 u'	0.1653
CIE1976 v'	0.4616
$\lambda_p$	545 nm
$\lambda_D$	491 nm
Purity	23 %
Duv	0.0288
S/P ratio	3.1

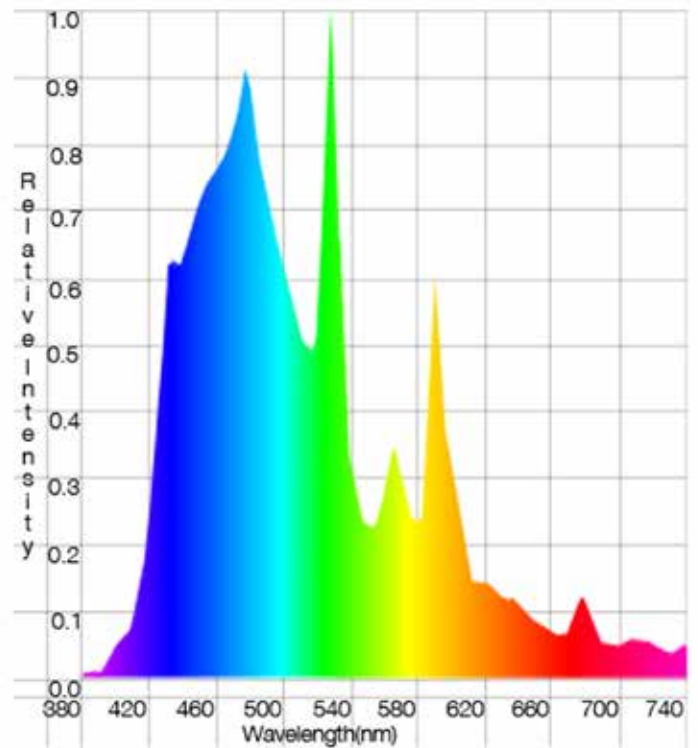
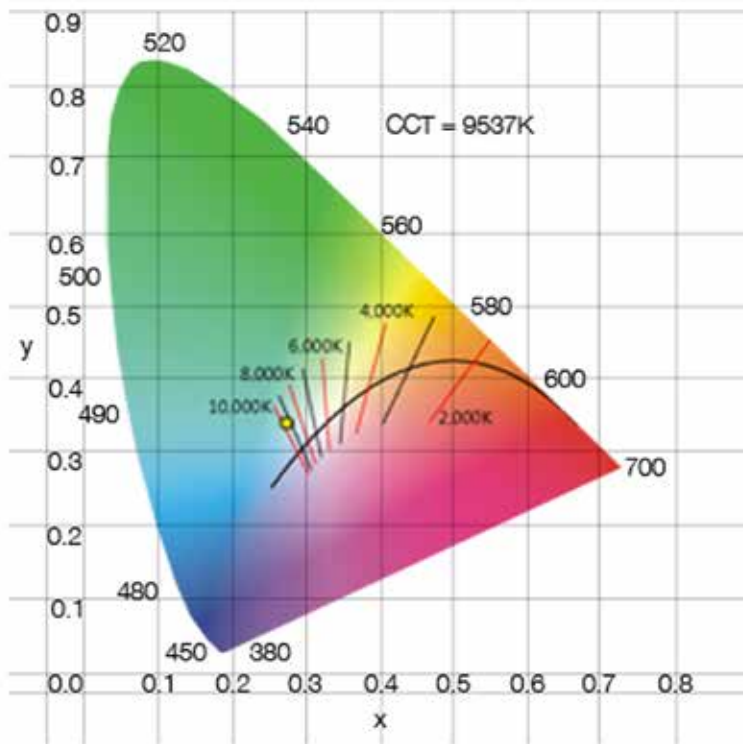
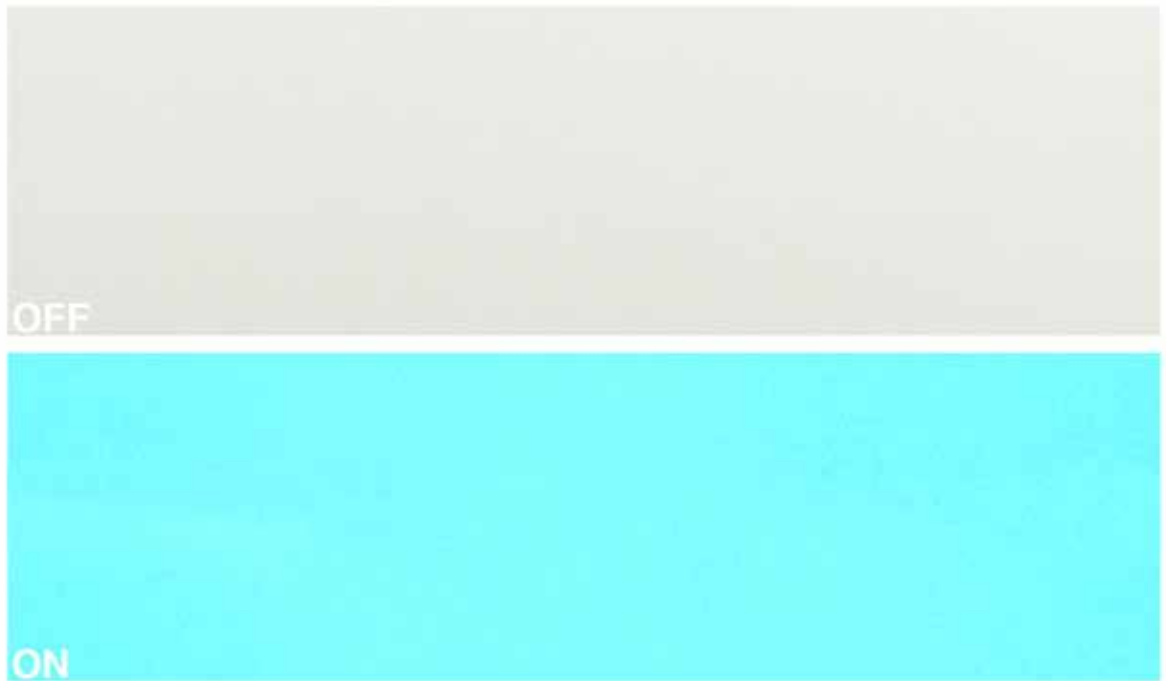

# Extreme Orange Technical Data

Parameter	Value
CCT	2700 k
CRI	0
CRI(Re)	0
CQS	0
Illuminance	392 lux
Foot Candle	36.4 fc
CIE1931 x	0.6258
CIE1931 y	0.3719
CIE1976 u'	0.4029
CIE1976 v'	0.5389
$\lambda_p$	602 nm
$\lambda_D$	600 nm
Purity	99 %
Duv	0.0000
S/P ratio	0.2

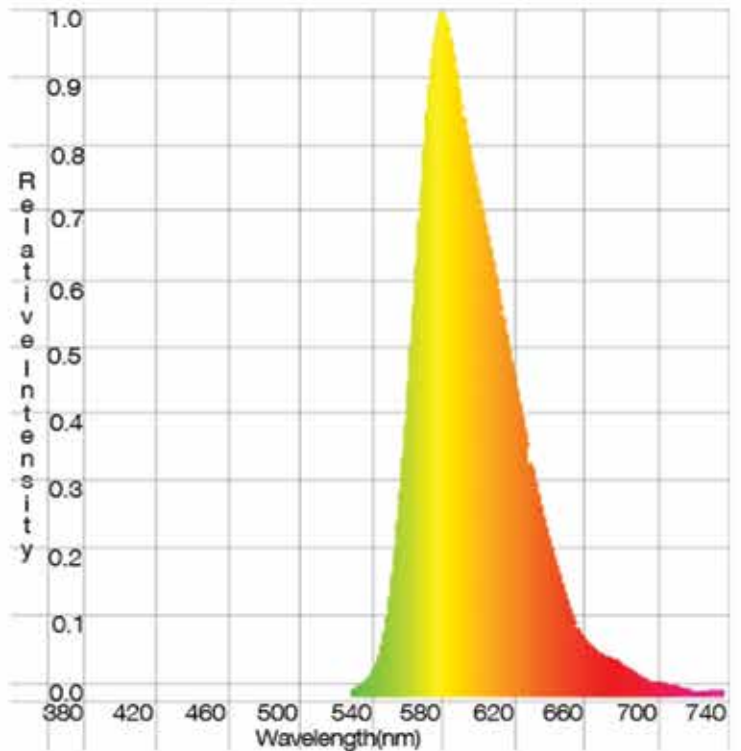
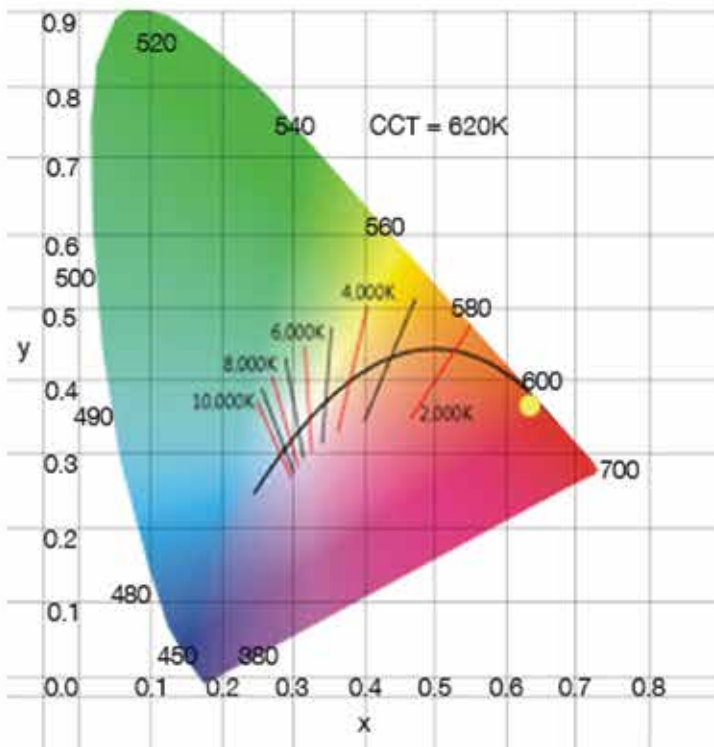

# Extreme Pink Technical Data

Parameter	Value
CCT	2700 k
CRI	0
CRI(Re)	0
CQS	0
Illuminance	213 lux
Foot Candle	19.8 fc
CIE1931 x	0.6177
CIE1931 y	0.3082
CIE1976 u'	0.4523
CIE1976 v'	0.5078
$\lambda_p$	623 nm
$\lambda_D$	624 nm
Purity	78 %
Duv	0.0000
S/P ratio	0.5

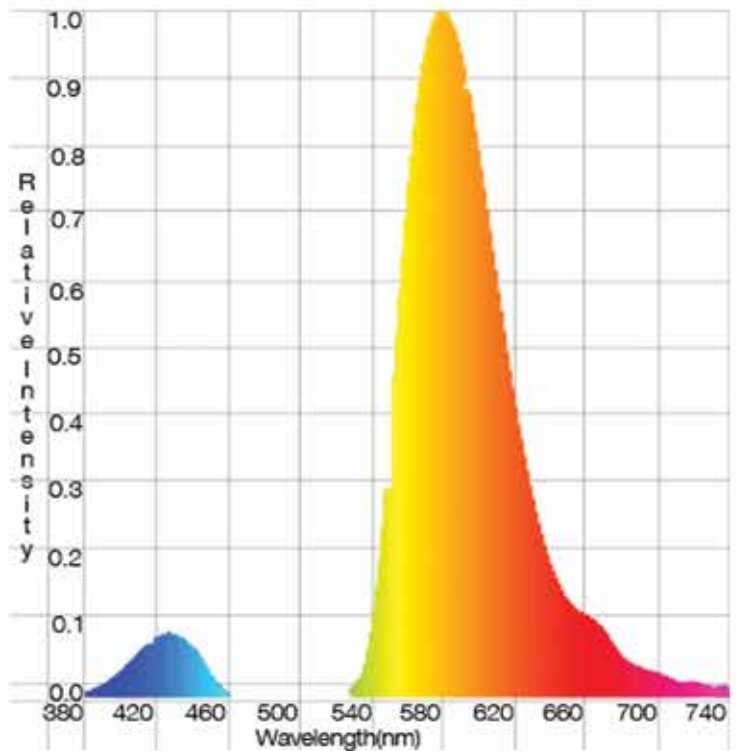
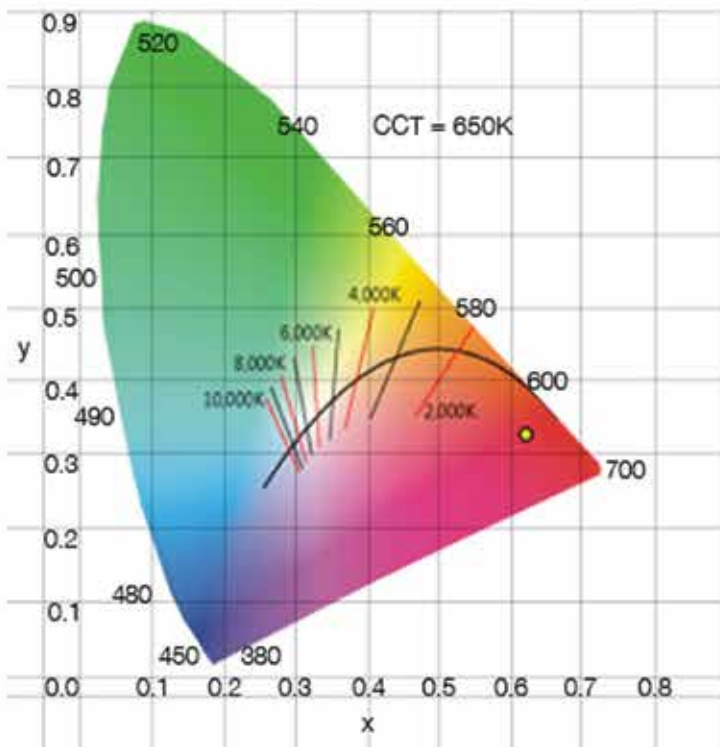

# Extreme Purple Technical Data

Parameter	Value
CCT	1500 k
CRI	0
CRI(Re)	0
CQS	0
Illuminance	39 lux
Foot Candle	3.6 fc
CIE1931 x	0.1787
CIE1931 y	0.1859
CIE1976 u'	0.1467
CIE1976 v'	0.3433
$\lambda_p$	476 nm
$\lambda_D$	478 nm
Purity	66 %
Duv	0.0000
S/P ratio	6.2

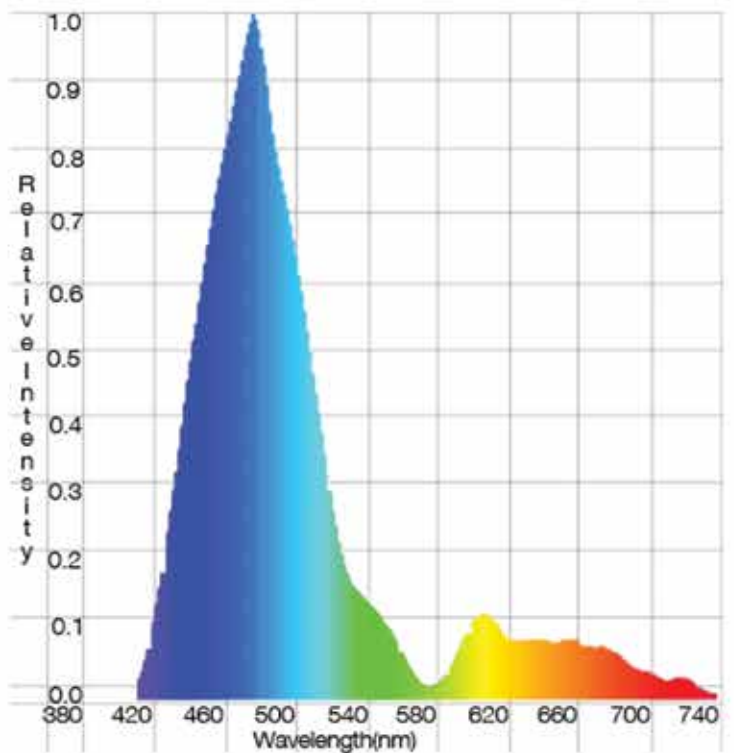
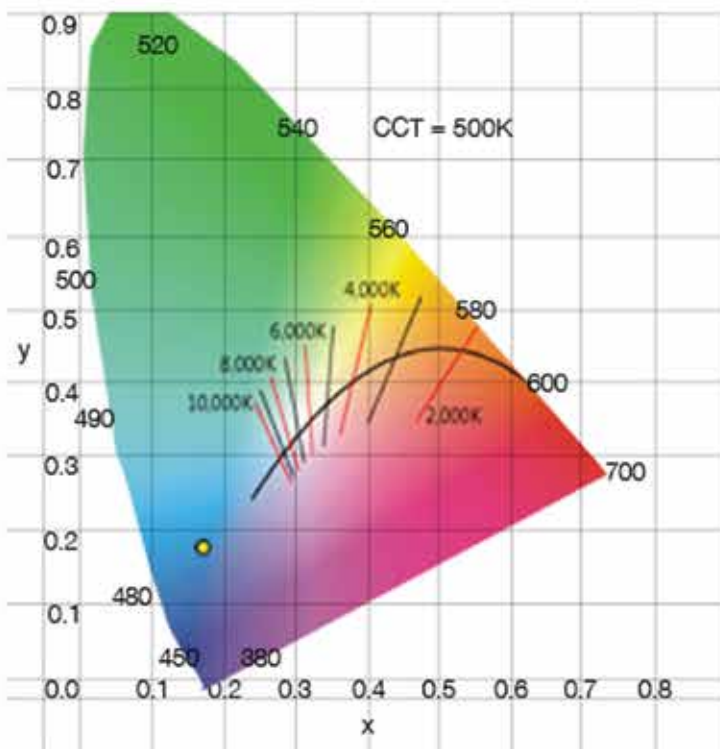
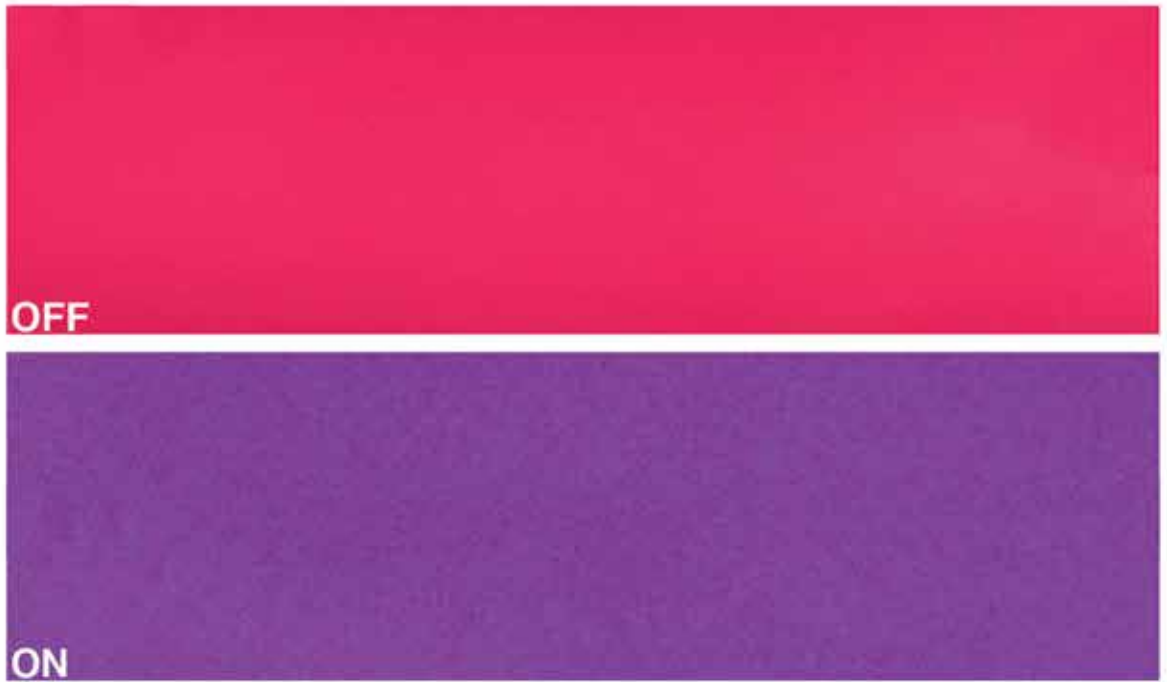



# X-ON Electronics

Largest Supplier of Electrical and Electronic Components

*Click to view similar products for [LED Backlighting category](#):*

*Click to view products by [LIGHT TAPE manufacturer](#):*

Other Similar products are found below :

[HBL0218](#) [SSB-COB7540GW](#) [SSB-DL6528SRW](#) [3G3DV130B4294](#) [SSB-CEL8040UWW](#) [SSB-CEL2718UWW](#) [8727900964912](#) [49131](#) [93112565](#)  
[0025 INT CLASSIC GLACIER WHITE](#) [0025 INT NATURAL BLUE](#) [0100 INT CLASSIC GLACIER WHITE](#) [0100 INT EXTREME ORANGE](#)  
[0100 INT NATURAL BLUE](#) [0200 INT EXTREME BLUE GREEN](#) [30531](#) [30565](#) [30586](#) [30588](#) [30589](#) [30590](#) [30637](#) [4052899149281](#)  
[4052899326453](#) [44241](#) [44865WFL](#) [44892WFL](#) [KB-2600ID](#) [KB-2855SGW](#) [4052899149229](#) [4052899913615](#) [L-875/4IDT](#) [L-875/4SRDT](#) [44244](#)  
[44860WFL](#) [44870WFL](#) [MR16 60ST 20W](#) [MR16 60ST 50W](#) [64465](#) [64695 ECO](#) [64698 ECO](#) [64701 ECO](#) [64702 ECO](#) [44890WFL](#) [SL2CD](#) [SKU](#)  
[165](#) [SKU 167](#) [SKU 193](#) [SKU 194](#) [SKU 203](#)