

Silicon PNP Epitaxial Planar Transistor (Complement to type 2SC3263)

Application : Audio and General Purpose

**Absolute maximum ratings** (Ta=25°C)

Symbol	2SA1294	Unit
V <sub>CBO</sub>	-230	V
V <sub>CEO</sub>	-230	V
V <sub>EBO</sub>	-5	V
I <sub>C</sub>	-15	A
I <sub>B</sub>	-4	A
P <sub>C</sub>	130(T <sub>C</sub> =25°C)	W
T <sub>J</sub>	150	°C
T <sub>stg</sub>	-55 to +150	°C

**Electrical Characteristics** (Ta=25°C)

Symbol	Conditions	2SA1294	Unit
I <sub>CBO</sub>	V <sub>CB</sub> =-230V	-100max	μA
I <sub>EBO</sub>	V <sub>EB</sub> =-5V	-100max	μA
V <sub>(BR)CEO</sub>	I <sub>C</sub> =-25mA	-230min	V
h <sub>FE</sub>	V <sub>CE</sub> =-4V, I <sub>C</sub> =-5A	50min*	
V <sub>CE(sat)</sub>	I <sub>C</sub> =-5A, I <sub>B</sub> =-0.5A	-2.0max	V
f <sub>r</sub>	V <sub>CE</sub> =-12V, I <sub>E</sub> =2A	35typ	MHz
COB	V <sub>CB</sub> =-10V, f=1MHz	500typ	pF

\*h<sub>FE</sub> Rank  $\bar{O}$ (50to100), Y(70to140)

**Typical Switching Characteristics (Common Emitter)**

V <sub>CC</sub> (V)	R <sub>L</sub> (Ω)	I <sub>C</sub> (A)	V <sub>BB1</sub> (V)	V <sub>BB2</sub> (V)	I <sub>B1</sub> (mA)	I <sub>B2</sub> (mA)	t <sub>on</sub> (μs)	t <sub>stg</sub> (μs)	t <sub>f</sub> (μs)
-60	12	-5	-10	5	-500	500	0.35typ	1.50typ	0.30typ

**External Dimensions MT-100(TO3P)**

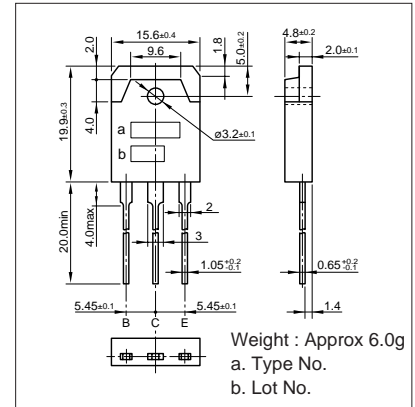

**I<sub>C</sub>-V<sub>CE</sub> Characteristics (Typical)**

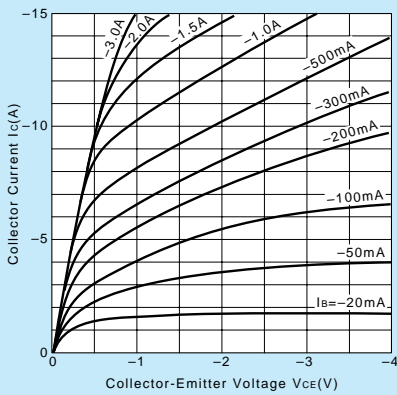

**V<sub>CE(sat)</sub>-I<sub>B</sub> Characteristics (Typical)**

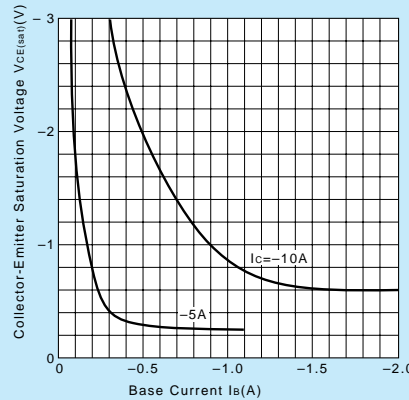

**I<sub>C</sub>-V<sub>BE</sub> Temperature Characteristics (Typical)**

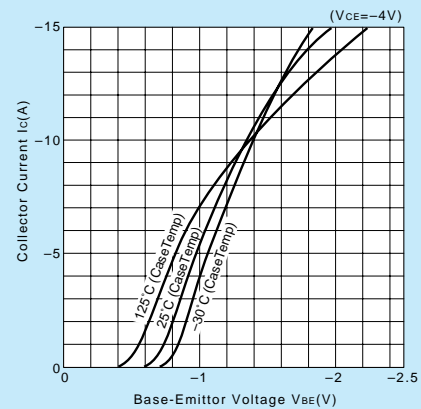

**h<sub>FE</sub>-I<sub>C</sub> Characteristics (Typical)**

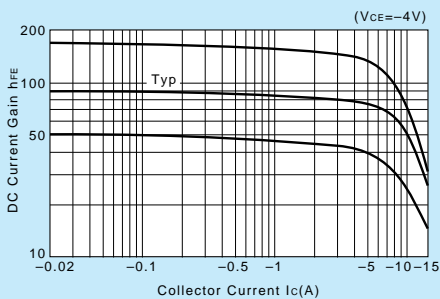

**h<sub>FE</sub>-I<sub>C</sub> Temperature Characteristics (Typical)**

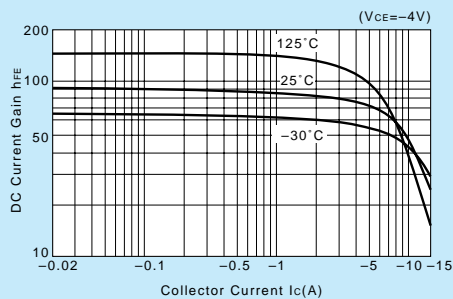

**θ<sub>j-a</sub>-t Characteristics**

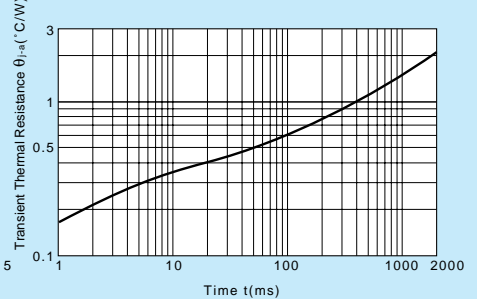

**f<sub>T</sub>-I<sub>E</sub> Characteristics (Typical)**

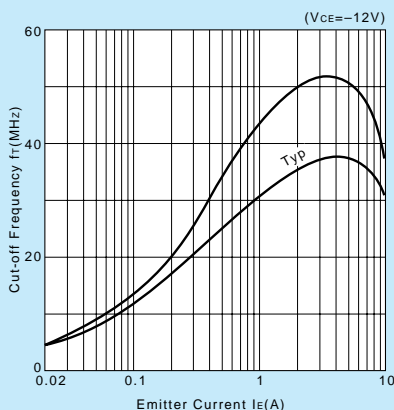

**Safe Operating Area (Single Pulse)**

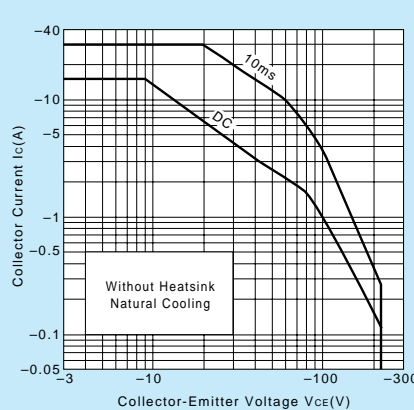

**P<sub>C</sub>-T<sub>a</sub> Derating**

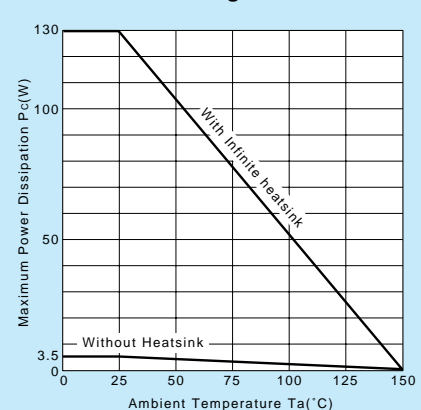

## X-ON Electronics

Largest Supplier of Electrical and Electronic Components

*Click to view similar products for [Allegro](#) manufacturer:*

Other Similar products are found below :

[A1221EUA-T](#) [A8672EEGTR-T](#) [ACS722LLCTR-20AB-T](#) [APEK4954ELP-01-T-DK](#) [APEK4491EES-01-T-DK](#) [APEK4490EES-01-T-DK](#)  
[ASEK758KCB-150U-T-DK](#) [ASEK758LCB-050B-T-DK](#) [APEK3901SEJ-01-T-DK](#) [APEK4403GEU-01-T-DK](#) [ASEK711KLC-12AB-T-DK](#)  
[APEK4979GLP-01-T-DK](#) [APEK4931MET-01-T-DK](#) [APEK4447SLJ-01-T-DK](#) [ASEK710KLA-6BB-T-DK](#) [ASEK758LCB-100B-T-DK](#)  
[ASEK770KCB-150B-T-DK](#) [ASEK770KCB-150U-T-DK](#) [APEK3931KJP-01-T-DK](#) [APEK4985SLP-01-T-DK](#) [ASEK711KLC-25AB-T-DK](#)  
[ASEK716KLA-12CB-T-DK](#) [ASEK770LCB-100U-T-DK](#) [APEK4953ELJ-01-T-DK](#) [APEK4952ELY-01-T-DK](#) [APEK4942GES-01-T-DK](#)  
[ASEK709LLF-20BB-T-DK](#) [ASEK758LCB-100U-T-DK](#) [ASEK709LLF-35BB-T-DK](#) [ASEK711KEX-31AB-T-DK](#) [ASEK713ELC-20A-T-DK](#)  
[ASEK716KLA-25CB-T-DK](#) [ASEK759KCB-150B-T-DK](#) [ASEK770ECB-200U-T-DK](#) [ASEK712ELC-30A-T-DK](#) [ASEK716KLA-6BB-T-DK](#)  
[ACS715ELCTR-30A-T](#) [A4949GLJTR-T](#) [A3922KLPTR-T](#) [A1171EEWLT-P](#) [APEK8651KLP-01-MH-DK](#) [APEK8650KLY-01-MH-DK](#)  
[ASEK-20-T-KIT-DK](#) [ASEK710KLA-25CB-T-DK](#) [ASEK770ECB-200B-T-DK](#) [APEK4402KLP-01-T-DK](#) [A3977SLPTR-T](#) [A1157LUA-T](#)  
[APEK4950ELJ-01-T-DK](#) [A5985GETTR-T](#)