

Type: **T0-3-8048/E**
 Article No.: **034116**

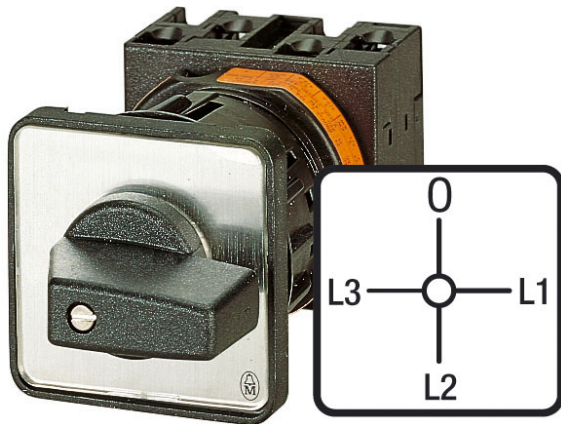

With black thumb-grip and grey front plate

With complete rotation in both directions

Measurement via current transformers

Ordering information

Design			Flush mounting
No. of poles			With 0 (Off) position

Contact sequence

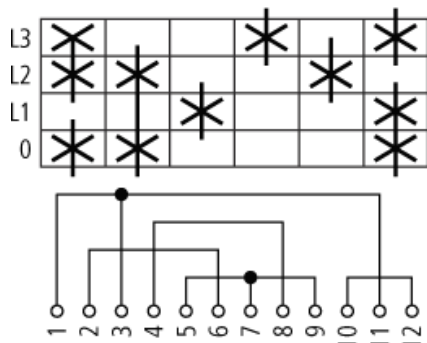

Front plate no.

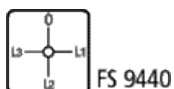

General

Standards			IEC/EN 60947, VDE 0660, IEC/EN 60204, CSA, UL Switch-disconnectors to
-----------	--	--	---

			IEC/EN 60947-3 Load-break switches to IEC/EN 60947-3
Lifespan, mechanical	Operations	$\times 10^6$	1
Maximum operating frequency	Operations/h		3000
Climatic proofing			Damp heat, constant, to IEC 60068-2-78; Damp heat, cyclical, to IEC 60068-2-30
Ambient temperature			
Open		°C	-25/50
Enclosed		°C	-25/40
Mounting position			As required
Documentation			Main catalogue HPL
Mechanical shock resistance (shock duration 20 ms)		g	> 15
Contacts			
Rated operational voltage	U_e	V AC	690
Rated impulse withstand voltage	U_{imp}	V AC	6000
Overvoltage category/pollution degree			III/3
Rated uninterrupted current			
open	I_u	A	20
Enclosed	I_u	A	20
Load-carrying capacity in intermittent operation, Class 12			
AB 25 % DF		$\times I_e$	2
AB 40 % DF		$\times I_e$	1,6
AB 60 % DF		$\times I_e$	1,3
Short-circuit rating			
Fuse		A gG/gL	20
Rated short-time withstand current (1 s current)	I_{cw}	A_{rms}	320
Safe isolation to VDE 0106 Part 101 and Part 101/A1			
between the contacts		V AC	440
Switching angles		°	90 60 45 30
Contact units			11
Double-break contacts			max. 22
Current heat loss per contact at I_e		W	0,6

Terminal capacities

Solid or stranded		mm ²	1 × (1 – 2.5) 2 × (1 – 2.5)
Flexible with ferrule to DIN 46228		mm ²	1 × (0.75 – 1.5) 2 × (0.75 – 1.5)
Terminal screw			M3.5
Tightening torque		Nm	1

Switching capacity

AC			
Rated making capacity $\cos \phi = 0.35$		A	130
Rated breaking capacity, motor load switch $\cos \phi = 0.35$			
230 V		A	100
400 V		A	110
500 V		A	80
690 V		A	60
Rated operational current 440 V load-break switch AC-21A	I_e	A	20
AC-3 motor load switch motor rating			
230 V	P	kW	3
230 V Star-delta	P	kW	4
400 V	P	kW	4
400 V Star-delta	P	kW	5,5
500 V	P	kW	5,5
500 V Star-delta	P	kW	7,5
690 V	P	kW	4
690 V Star-delta	P	kW	5,5
AC-23A Motor load switches (main switches maintenance switches)			
230 V	P	kW	3,5
400 V	P	kW	11
500 V	P	kW	7,5
Rated operational current control switch AC-15			
230 V	I_e	A	6
400 V	I_e	A	4
500 V	I_e	A	2
DC			

DC-1, Load-break switches L/R = 1 ms			
Rated operational current	I_e	A	10
Voltage per contact pair in series		V	60
DC-21A			
Rated operational current 240 V	I_e	A	1
240 V Contacts		Quantity	1
DC-23A, Motor load switches L/R = 15 ms			
24 V			
Rated operational current	I_e	A	10
Contacts		Quantity	1
48 V			
Rated operational current	I_e	A	10
Contacts		Quantity	2
60 V			
Rated operational current	I_e	A	10
Contacts		Quantity	3
120 V			
Rated operational current	I_e	A	5
Contacts		Quantity	3
240 V			
Rated operational current	I_e	A	5
Contacts		Quantity	5
DC-13, Control switches L/R = 50 ms			
Rated operational current	I_e	A	10
Voltage per contact pair in series		V	32
Control circuit reliability at 24 V DC, 10 mA	Fault probability	H_F	$< 10^{-5}$, < 1 fault in 100000 operations
Notes			
			For mechanical shock resistance: T3.../I... >12g Applies to T0(3).../SVB: isolating characteristics to IEC/EN 60947 U for rated operational voltage up to 500 V AC Applies to rated uninterrupted current I_u of the contact: with T5-4-8344/I5 max. 95 A

			<p>For terminal capacity solid, stranded and flexible: T0(3), (6), (8)...: Maximum of 2 cross-section sizes difference admissible between 2 conductors T5(B)-...: Maximum of 1 cross-section size difference admissible between 2 conductors For type T8-3-8342/... the following applies: switching angle = 90° and flat connection = 1 busbar 25 × 5 or 2 busbars 20 × 3</p>
--	--	--	---

Dimensions

			not included
			Diameter of drilled hole Door
Explanation			<p>For utilisation category AC-4 (extreme load: 100 % inching, reversing or plugging) The blocked rotor current of the motor should not exceed the rated current of the switch for AC-21A to ensure a reasonable device lifespan.</p>

Dimensions

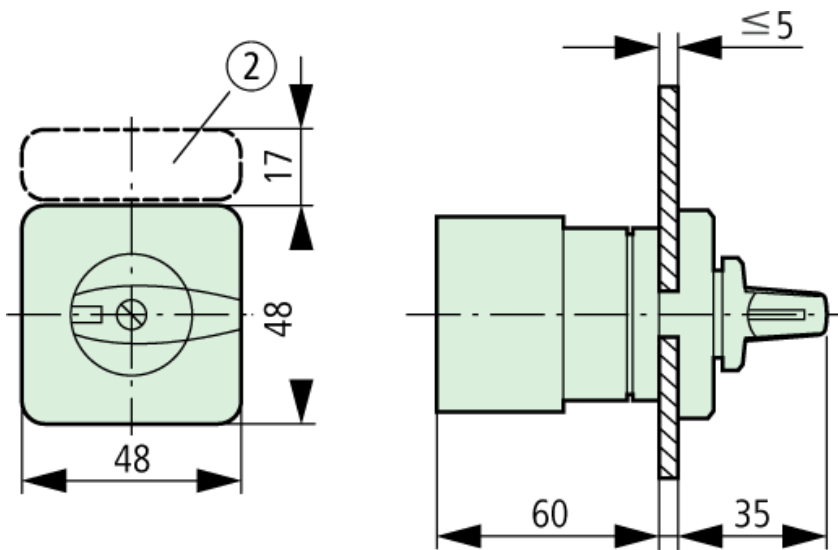

Dimensions

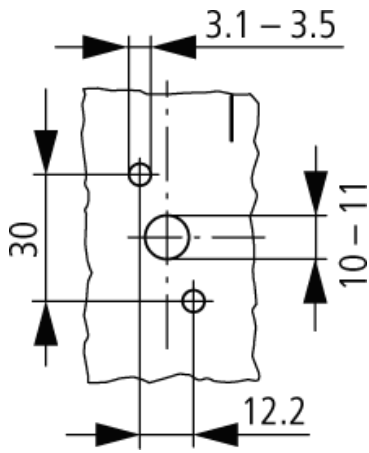

Dimensions

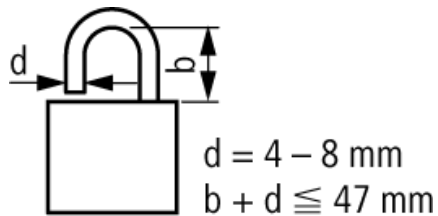

Characteristic curve

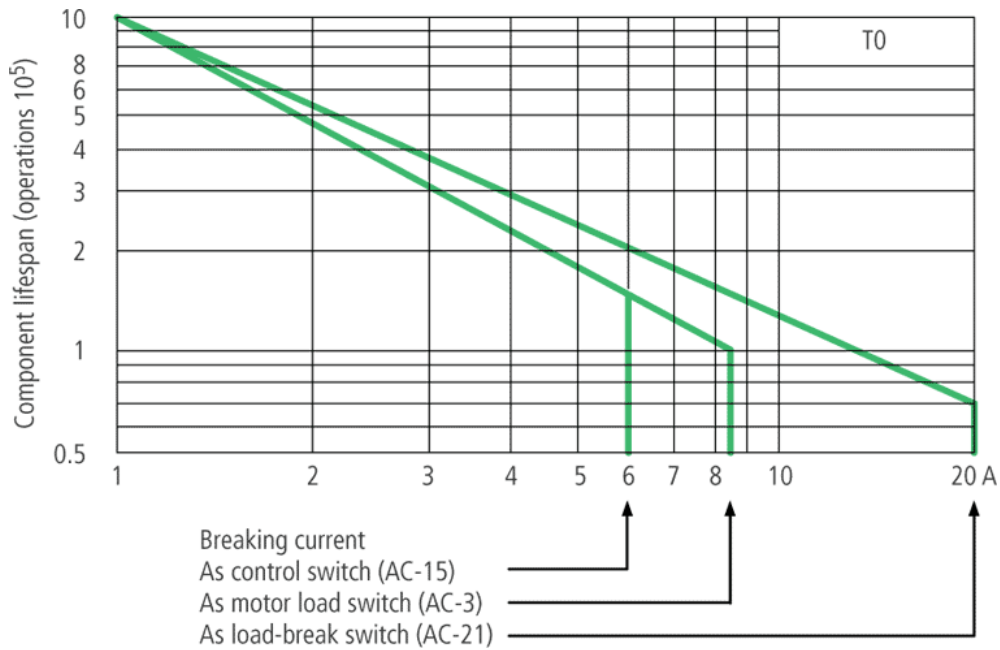

Moeller GmbH, Hein-Moeller-Str. 7-11, D-53115 Bonn
 E-Mail: catalog@moeller.net, Internet: www.moeller.net, <http://catalog.moeller.net>
 Copyright 2006 by Moeller GmbH. Subject to modifications. HPL-C2006GB-INT V2.3

X-ON Electronics

Largest Supplier of Electrical and Electronic Components

Click to view similar products for [Eaton](#) manufacturer:

Other Similar products are found below :

[BK1-S506-2-R](#) [FHN31G1](#) [CH222B](#) [SAMI-2I](#) [SAMI-6I](#) [LPN-RK-25SP](#) [ZE6](#) [ZE9](#) [LPN-RK-15SP](#) [LPN-RK-3SP](#) [SAMI-1I](#) [2499](#) [GMC-500MA](#) [AT-20](#) [BK/SC-45](#) [AGC-1-2](#) [BK/MDA-15](#) [BK/MDA-1](#) [BK/C519-1A](#) [BK/MDL-3-2/10](#) [89096-015](#) [8943K28](#) [8946K153](#) [8961K155](#) [M22-DH-Y](#) [M22-DLH-Y](#) [M22-D-R-GB0/K11](#) [M22-LCH-R](#) [M22-L-R/R](#) [M22-WLK3-B](#) [63ET](#) [6422](#) [6580](#) [CTX20-16-52LP-R](#) [CWL530FI](#) [CXM/CO/GP/R/BB](#) [6HD36](#) [714125](#) [MBO-2](#) [7314K36](#) [7321K2](#) [ETF-200MA](#) [F02A-1-1/2A](#) [F02A-1-1/2AS](#) [F02A-1AS](#) [F02A-3/4A](#) [F03A250V10A](#) [F03A250V12A](#) [MDA-2-8/10-R](#) [MDA-30A](#)