

### TOSHIBA LED Lamps

# TLRV1022(T14,F), TLRMV1022(T14,F), TLSV1022(T14,F), TLOV1022(T14,F), TLAV1022(T14,F), TLYV1022(T14,F), TLGV1022(T14,F), TLPGV1022(T14,F)

### Panel Circuit Indicator

- Surface-mount devices, Pb(Lead) free
- 1.6 (L) × 0.8 (W) × 0.45 (H) mm
- InGaAlP LEDs
- High luminous intensity and low power consumption
- Suitable for backlighting
- Colors: red, orange, amber, yellow, green, pure green
- Standard embossed tape packing  
4-mm pitch: T14 (4000/reel)
- Applications: Backlighting (mobile phones, LCD displays, switching displays)  
Indicators for compact devices and battery-driven devices etc.

### Color and Material

Product Name	Color	Material
TLRV1022	Red	InGaAlP
TLRMV1022	Red	
TLSV1022	Red	
TLOV1022	Orange	
TLAV1022	Amber	
TLYV1022	Yellow	
TLGV1022	Green	
TLPGV1022	Pure Green	

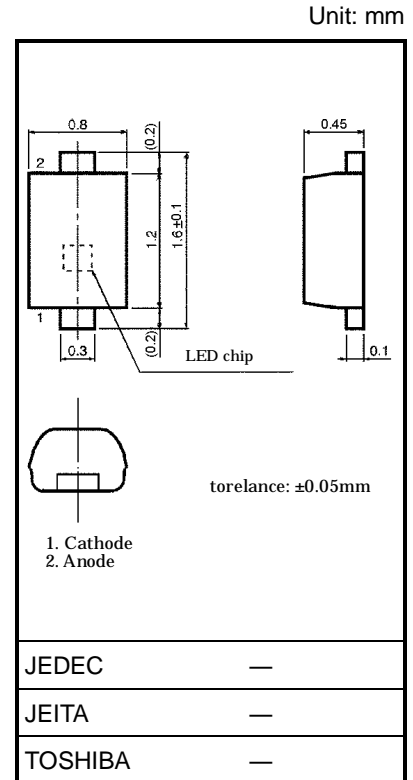

Weight: 0.001 g (typ.)

### Maximum Ratings (Ta = 25°C)

Product Name	Forward Current I <sub>F</sub> (mA)	Reverse Voltage V <sub>R</sub> (V)	Power Dissipation P <sub>D</sub> (mW)	Operating Temperature T <sub>opr</sub> (°C)	Storage Temperature T <sub>stg</sub> (°C)
TLRV1022	15	4	34.5	-40~100	-40~100
TLRMV1022					
TLSV1022					
TLOV1022					
TLAV1022					
TLYV1022					
TLGV1022					
TLPGV1022					



For part availability and ordering information please call Toll Free: 800.984.5337  
Website: [www.marktechopto.com](http://www.marktechopto.com) | Email: [info@marktechopto.com](mailto:info@marktechopto.com)

### Electrical Characteristics (Ta = 25°C)

Product Name	Forward Voltage $V_F$			Reverse Current $I_R$		
	Min	Typ.	Max	$I_F$	Max	$V_R$
TLRV1022	—	1.8	2.1	5	10	4
TLRMV1022	—	1.8	2.1			
TLSV1022	—	2.0	2.3			
TLOV1022	—	2.0	2.3			
TLAV1022	—	2.0	2.3			
TLYV1022	—	2.0	2.3			
TLGV1022	—	2.0	2.3			
TLPGV1022	—	2.0	2.3			
Unit	V			mA	$\mu$ A	V

### Optical Characteristics-1 (Ta = 25°C)

Product Name	Luminous Intensity $I_V$			$I_F$
	Min	Typ.	Max	
TLRV1022	4.76	15	—	5
TLRMV1022	4.76	20	—	
TLSV1022	8.5	30	—	
TLOV1022	8.5	38	—	
TLAV1022	8.5	25	—	
TLYV1022	8.5	25	—	
TLGV1022	4.76	14	—	
TLPGV1022	1.53	3.5	—	
Unit	mcd			mA

### Optical Characteristics-2 (Ta = 25°C)

Product Name	Peak Emission Wavelength $\lambda_p$			Emission Spectrum $\Delta\lambda$			$I_F$	
	Min	Typ.	Max	Typ.	Min	Typ.		Max
TLRV1022	—	644	—	18	624	630	638	5
TLRMV1022	—	636	—	17	620	626	634	
TLSV1022	—	623	—	17	607	613	621	
TLOV1022	—	612	—	17	599	605	613	
TLAV1022	—	596	—	13	585	592	599	
TLYV1022	—	590	—	13	581	587	595	
TLGV1022	—	574	—	13	565	571	576	
TLPGV1022	—	558	—	11	—	561	566	
Unit	nm			nm	nm			mA

Note: The visible LED lamp also emits some IR light.

If a photodetector is located near the LED lamp, please ensure that it will not be affected by the IR light.

**TLRV1022**

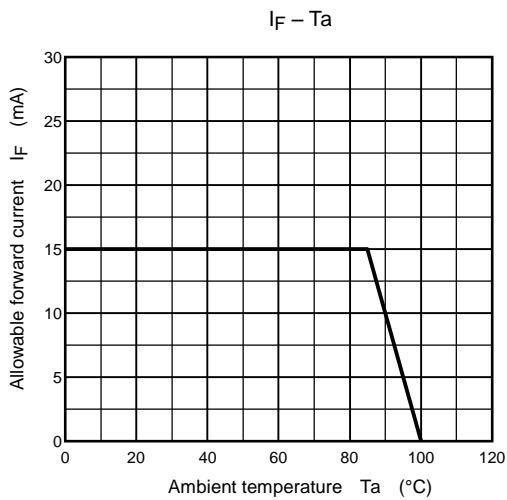
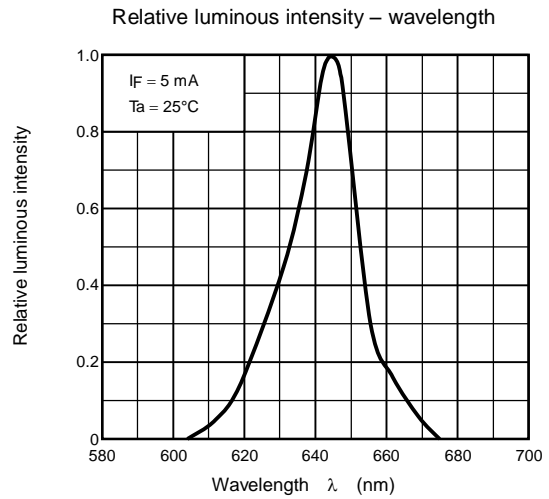
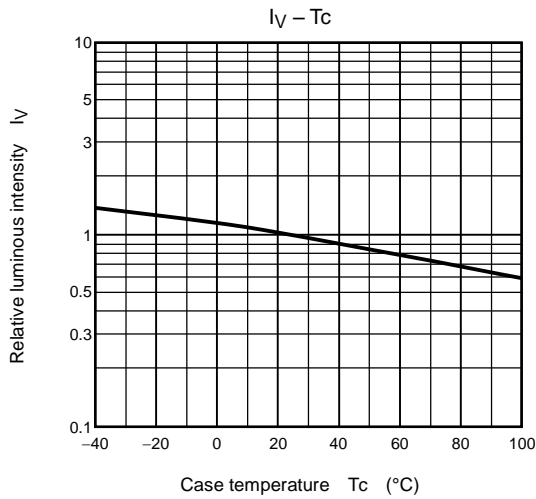
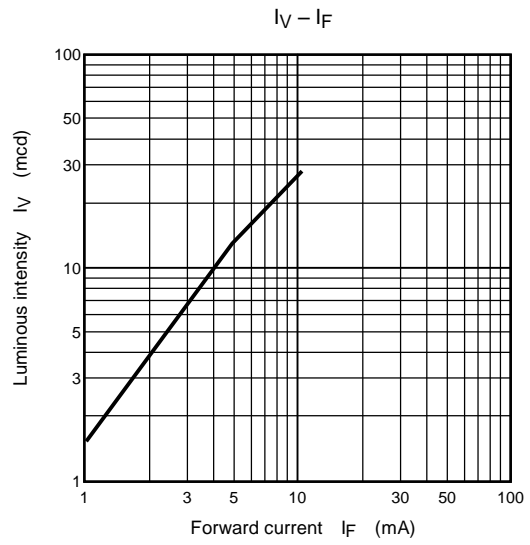
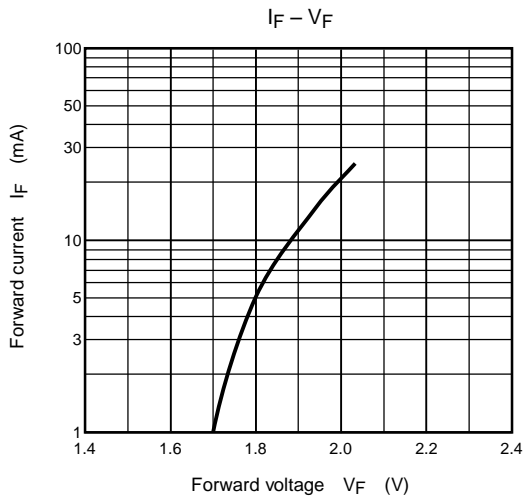

**TLRMV1022**

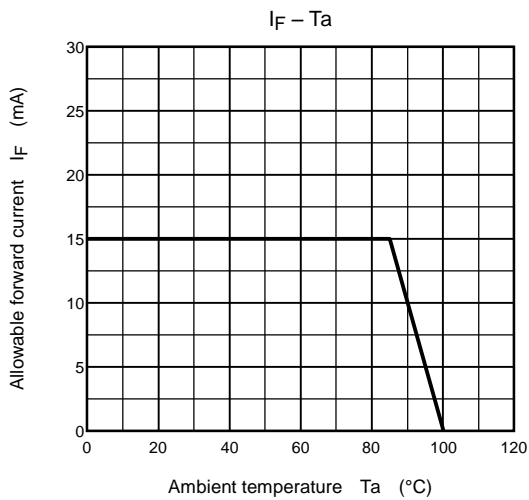
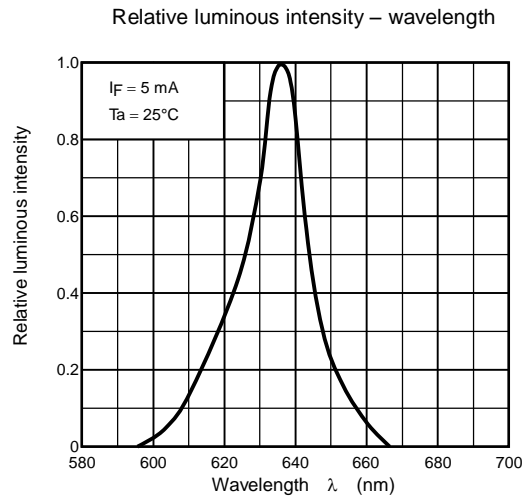
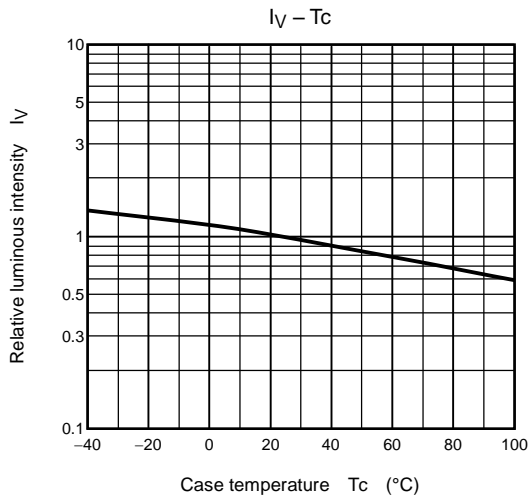
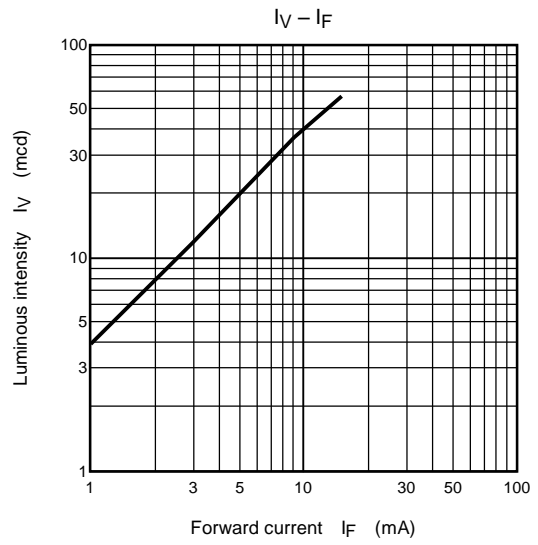
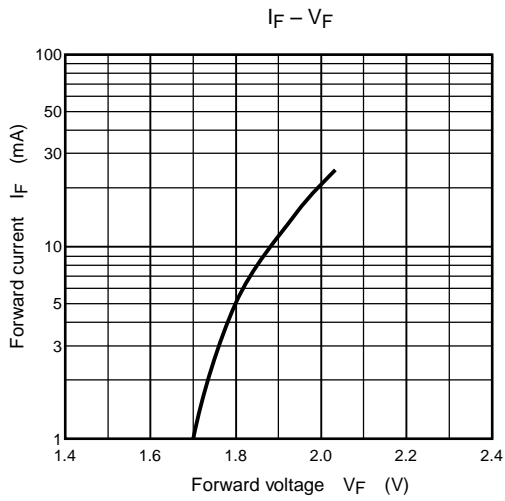

**TLSV1022**

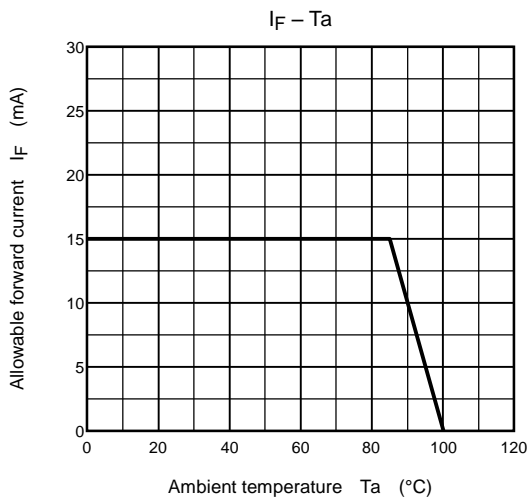
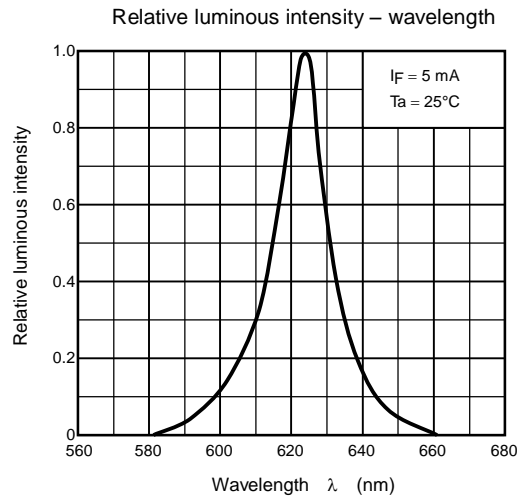
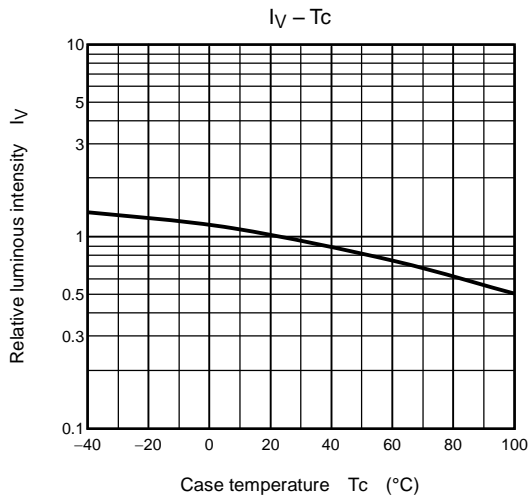
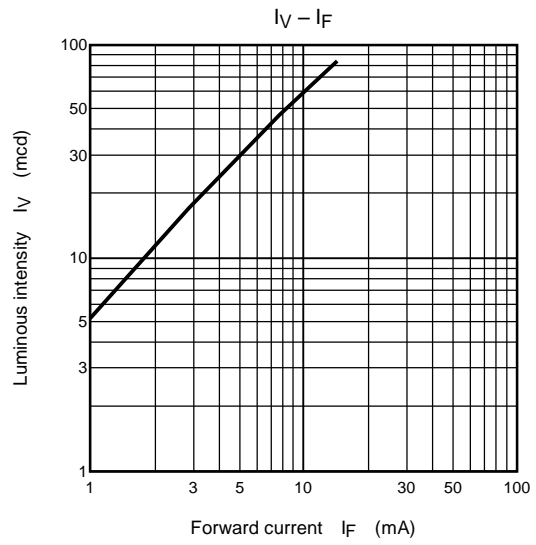
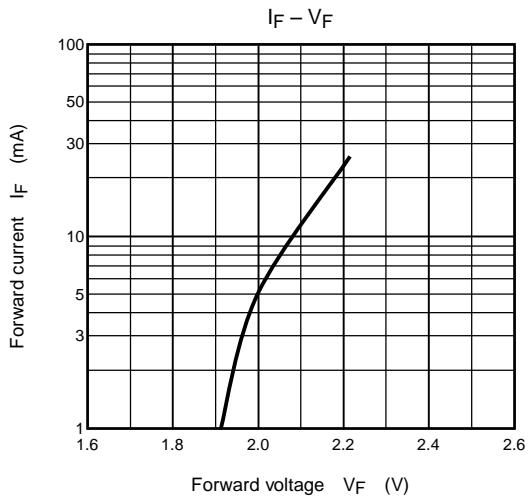

**TLOV1022**

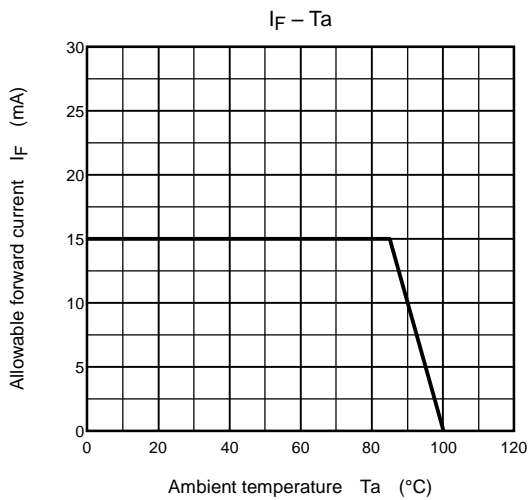
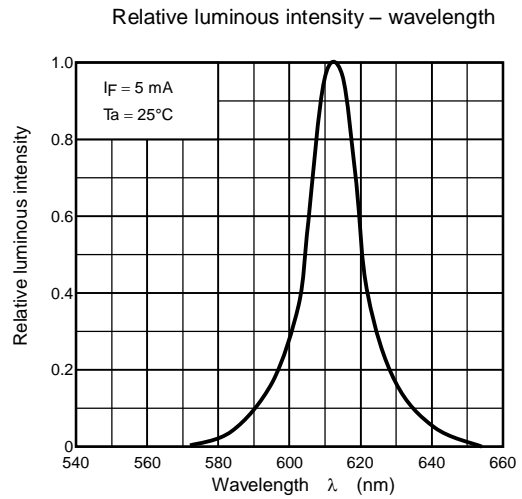
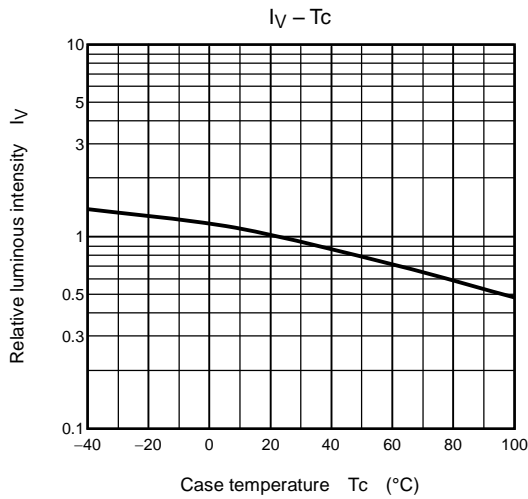
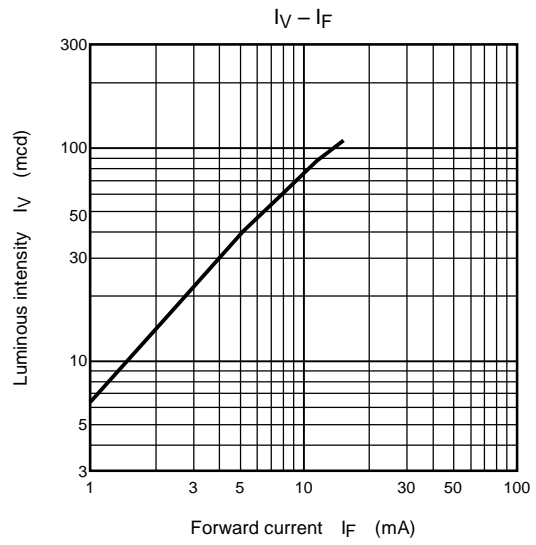
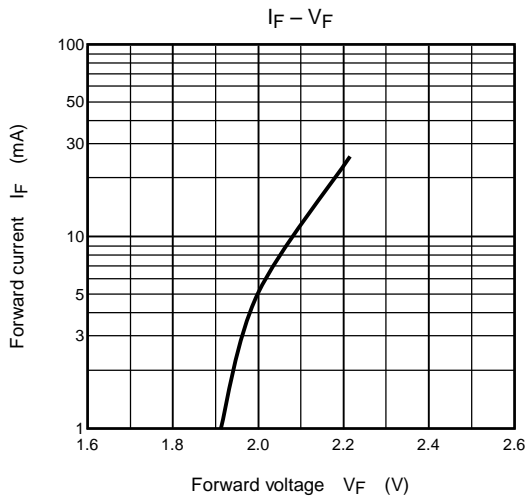

**TLAV1022**

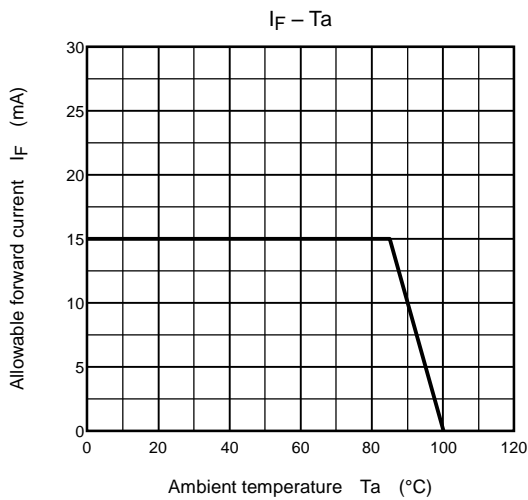
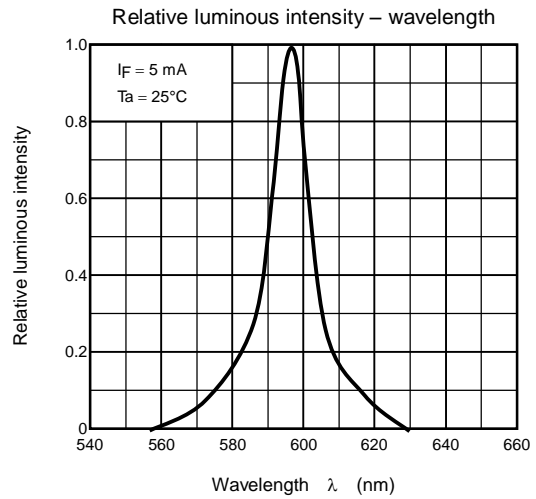
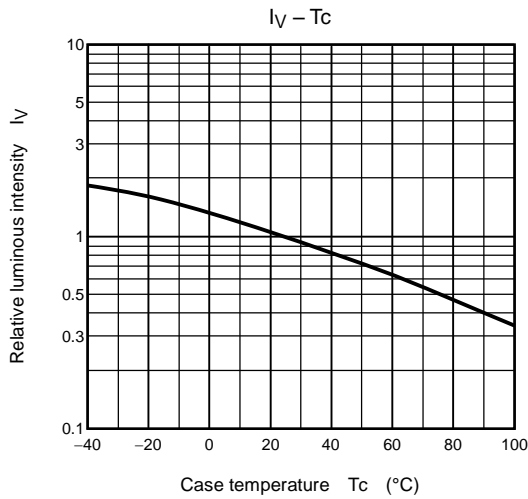
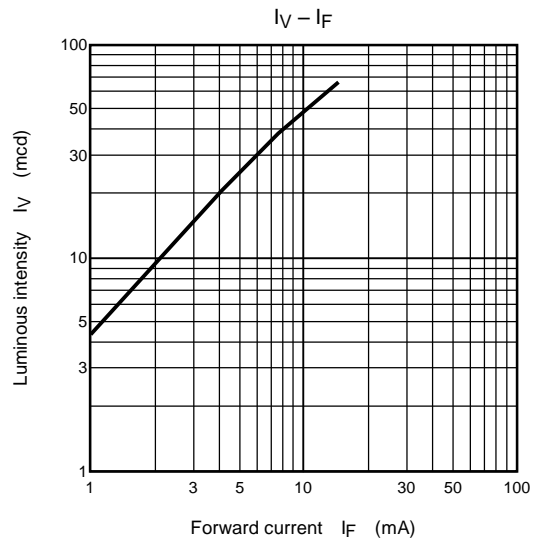
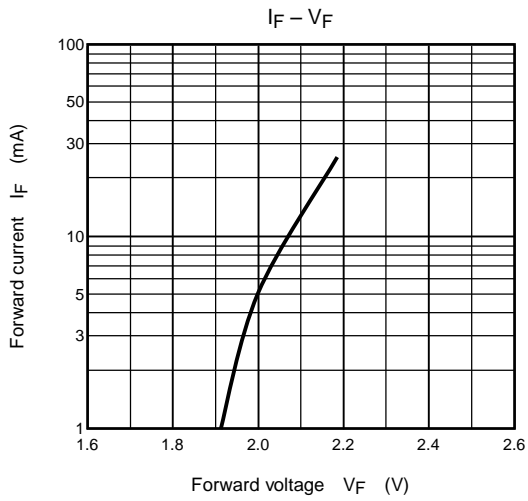

**TLYV1022**

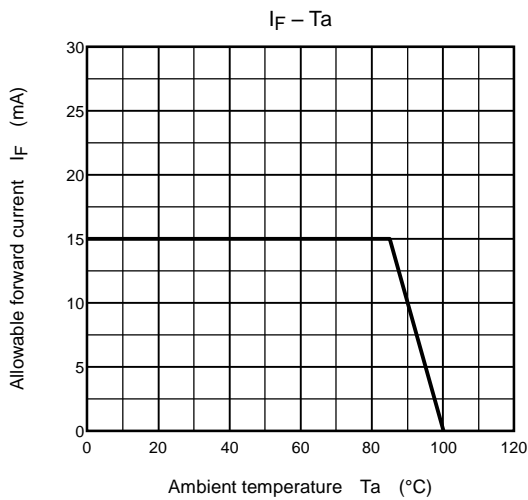
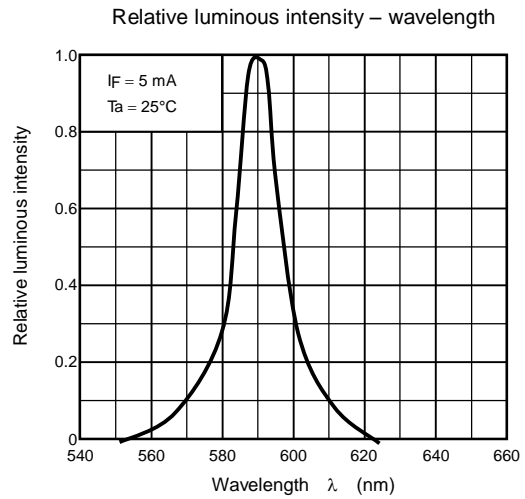
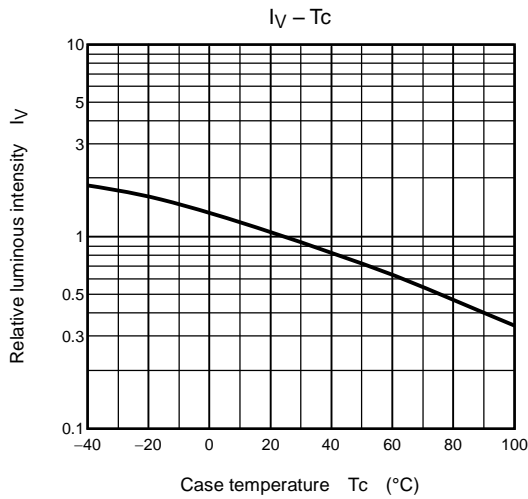
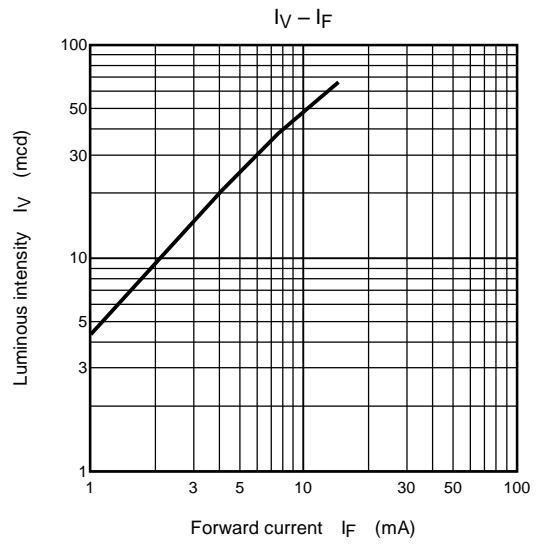
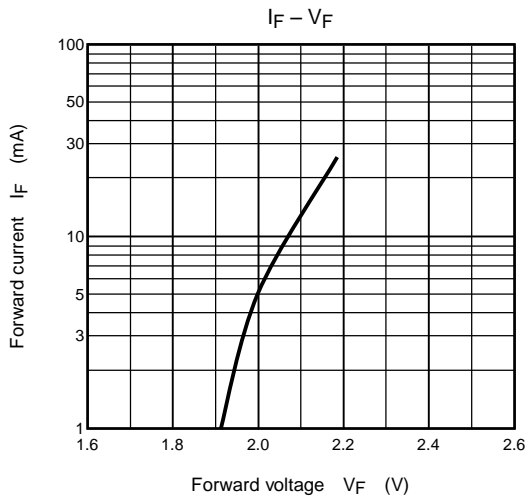



### TLGV1022

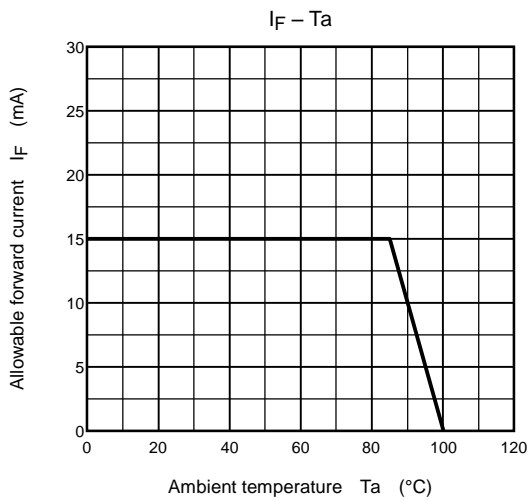
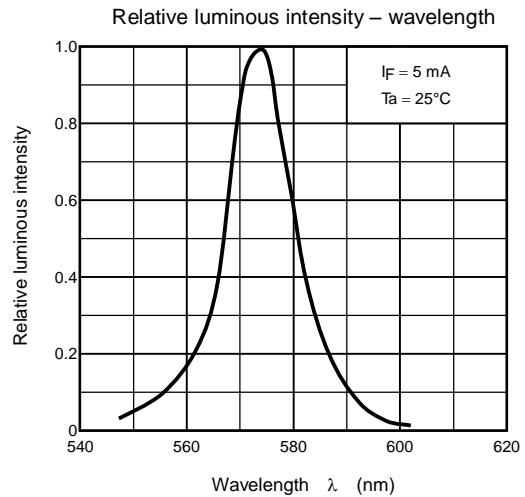
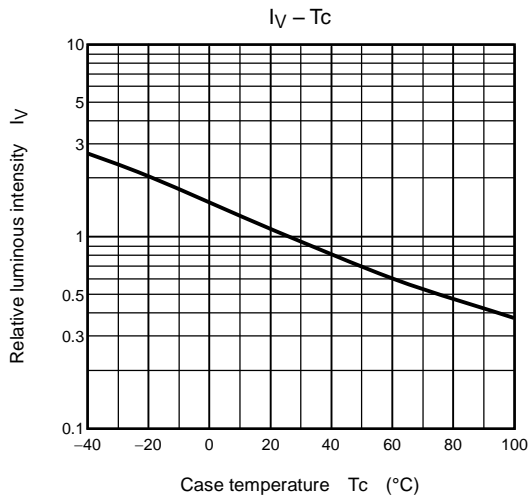
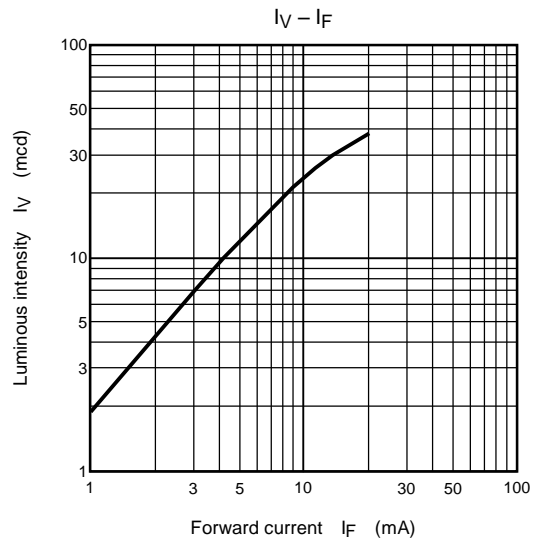
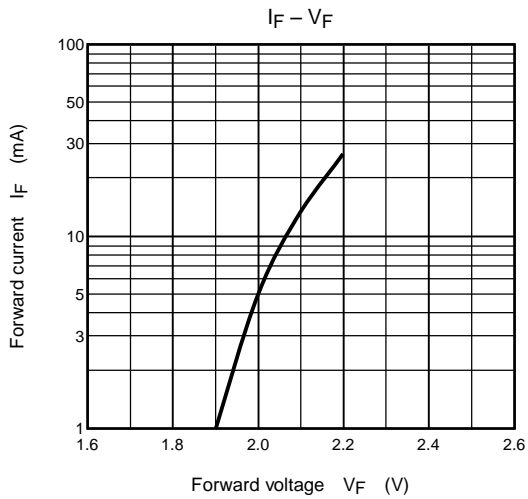

**TLPGV1022**

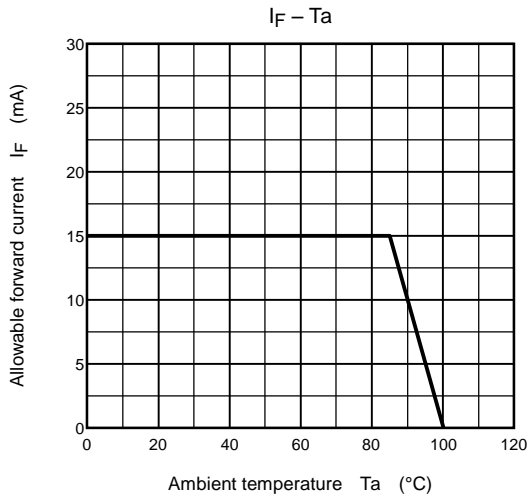
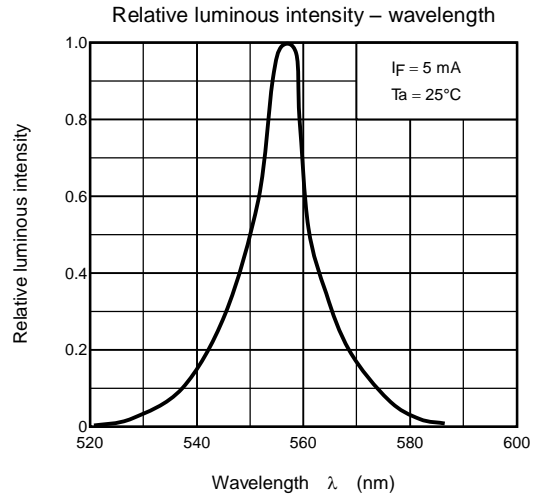
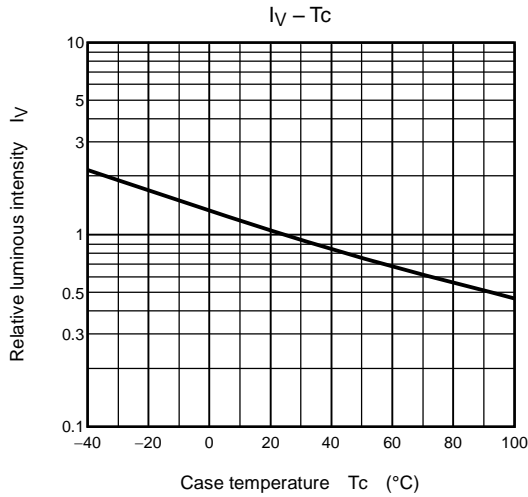
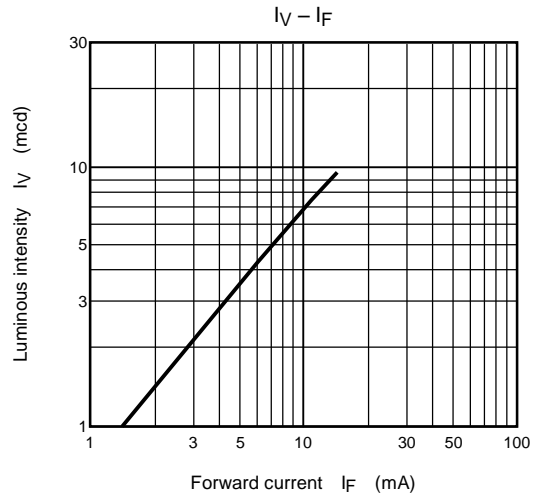
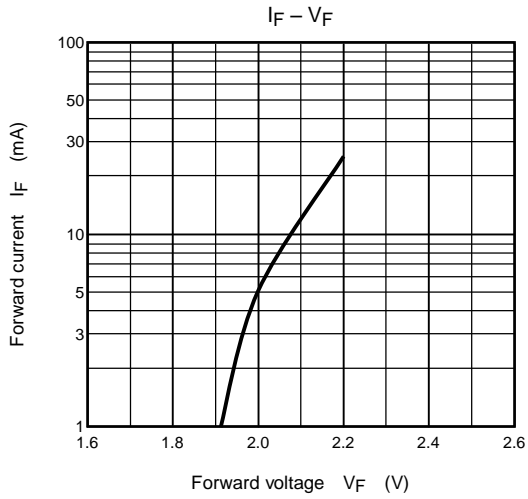

**Radiation Pattern**

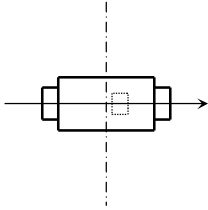
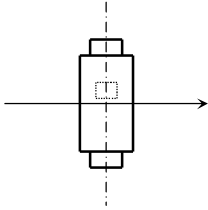
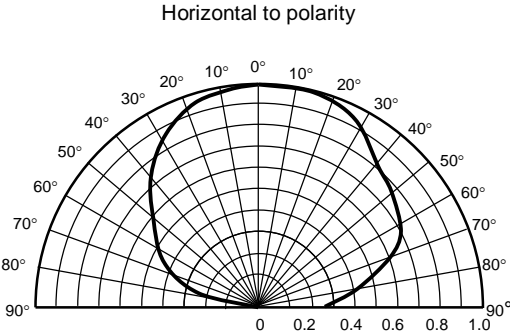
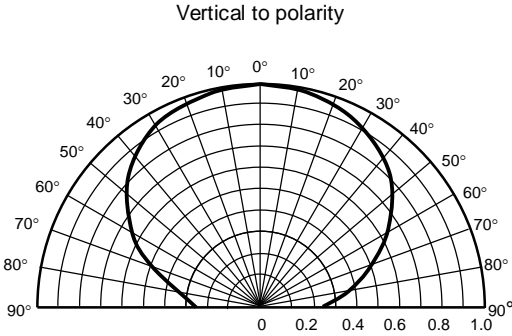

## Packaging

These LED devices are packed in an aluminum envelope with a silica gel and a moisture indicator to avoid moisture absorption. The optical characteristics of the devices may be affected by exposure to moisture in the air before soldering and they should therefore be stored under the following conditions:

1. This moisture proof bag may be stored unopened within 12 months at the following conditions.  
Temperature: 5°C~30°C  
Humidity: 90% (max)
2. After opening the moisture proof bag, the devices should be assembled within 168 hours in an environment of 5°C to 30°C/70% RH or below.
3. If upon opening, the moisture indicator card shows humidity 30% or above (Color of indication changes to pink) or the expiration date has passed, the devices should be baked in taping with reel.  
After baking, use the baked devices within 72 hours, but perform baking only once.  
Baking conditions: 60±5°C, for 12 to 24 hours.  
Expiration date: 12 months from sealing date, which is imprinted on the same side as this label affixed.
4. Repeated baking can cause the peeling strength of the taping to change, then leads to trouble in mounting. Furthermore, prevent the devices from being destructed against static electricity for baking of it.
5. If the packing material of laminate would be broken, the air tightness would deteriorate. Therefore, do not throw or drop the packed devices.

## Mounting Method

### Soldering

- Reflow soldering

Temperature profile (Pb soldering)

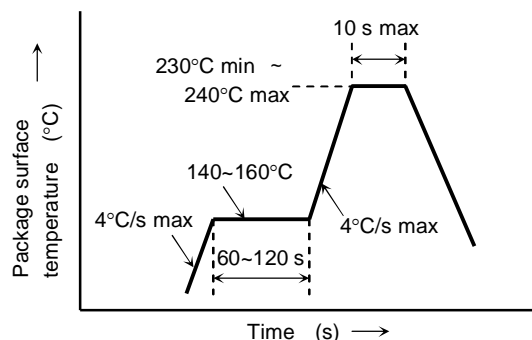

Recommended Temperature profile for Pb-free soldering

(See Note)

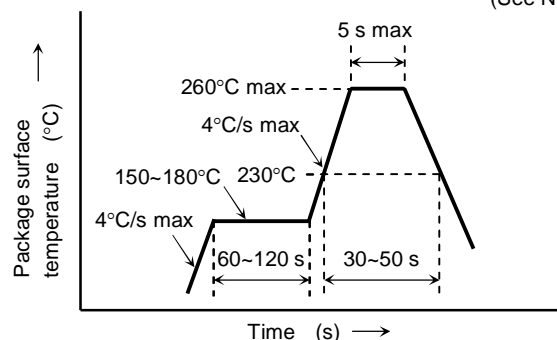

- First reflow soldering  
First reflow soldering should be performed within 168 h after opening the package under the above "Recommendable temperature profile for Pb-free soldering" profile( recommendable storage condition is 5~30°C with temperature and 70% RH max).
- Second reflow soldering  
Second reflow soldering should be performed within 168 h after the first reflow under the above profile( recommendable storage condition is 5~30°C with temperature and 70% RH max).
- Do not perform flow soldering nor soldering dip .
- Please make any necessary soldering corrections by hand.  
(only once at each soldering point)  
Soldering iron : 25 W  
Temperature : 300°C or less  
Time : within 3 s (for each lead)

Note: This product's leads are Pb-free, and Pb-free soldering is required. However if it is mounted with Pb solder, recommendable temperature profile is the above "temperature profile for Pb soldering".

## Recommended soldering pattern

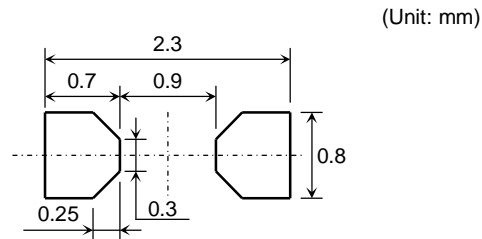

## Cleaning

When cleaning is required after soldering, Toshiba recommends the following cleaning solvents. It is confirmed that these solvents have no effect on semiconductor devices in our dipping test (under the recommended conditions). In selecting the one for your actual usage, please perform sufficient review on washing condition, using condition and etc.

ASAHI CLEAN AK-225AES	: (made by ASAHI GLASS)
KAO CLEAN TROUGH 750H	: (made by KAO)
PINE ALPHA ST-100S	: (made by ARAKAWA CHEMICAL)
TOSHIBA TECHNOCARE (FRW-17, FRW-1, FRV-100)	: (made by GE TOSHIBA SILICONES)

## Precaution when mounting

Do not apply force to the plastic part of the LED under high-temperature conditions.

To avoid damaging the LED plastic do not apply friction using hard materials.

In installing PCB in a product set after LEDs are assembled on, ensure that other components do not contact with the device.

## Tape Specifications

### 1. Product number format

The type of package used for shipment is denoted by a symbol suffix after the product number. The method of classification is as below. (However, this method does not apply to products whose electrical/optical characteristics differ from standard Toshiba specifications)

(1) Tape Type: T14 (4-mm pitch)

(2) Example

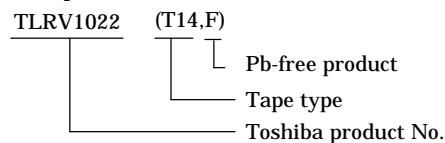

### 2. Handling precautions

Tape material protected against static electricity. However, static electricity may occur depending on quantity of charged static electricity and a device may attach to a tape, or a device may be unstable when peeling a tape cover.

- (a) Since tape materials may accumulate an electrostatic charge, use an ionizer to neutralize the ambient air.
- (b) For transport and temporary storage of devices, use containers (boxes and bags) and jigs that are made of anti-static materials or of materials which dissipate electrostatic charge.

**3. Tape dimensions**

(Unit: mm)

Item	Symbol	Value	Tolerance
Carrier tape	Width	W	±0.2
	Thickness	t <sub>1</sub>	±0.05
Feed hole	Diameter	D <sub>0</sub>	±0.1
	Pitch	P <sub>0</sub>	±0.1
	Position	E	±0.1
Distance from center line	Vertical Direction (1)	P <sub>1</sub>	±0.1
	Vertical Direction (2)	P <sub>2</sub>	±0.1
	Horizontal Direction	F	±0.1

Item	Symbol	Value	Tolerance
Cavity	Length	B <sub>1</sub>	±0.05
		B	±0.05
Cavity	Width	A	±0.05
		A <sub>1</sub>	±0.05
Cavity	Depth	t <sub>2</sub>	±0.05
Cavity	Diameter of mark hole	D <sub>1</sub>	±0.05

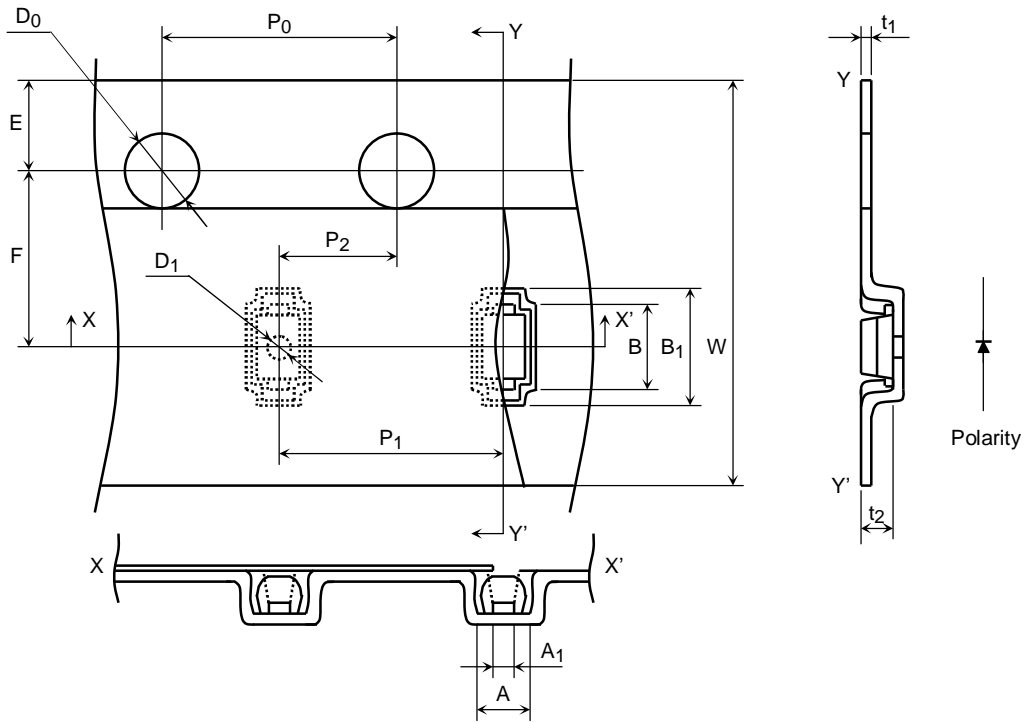

4. Reel dimensions

Unit: mm

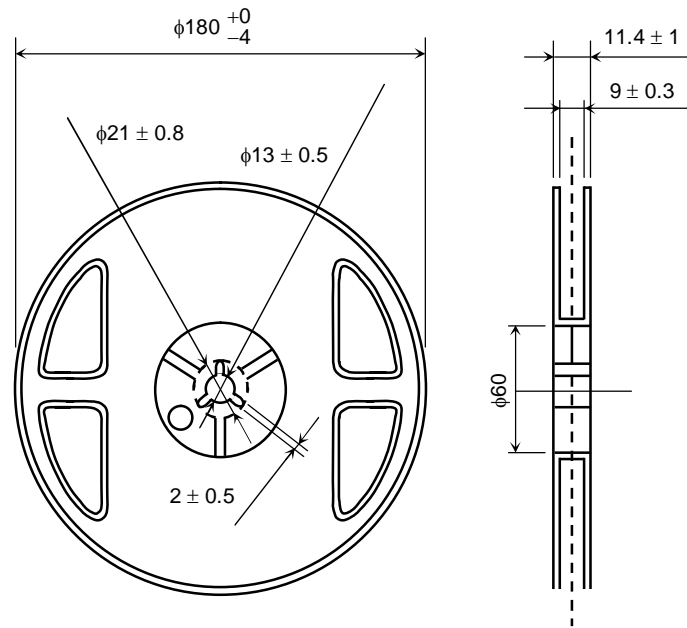

5. Leader and trailer section of tape

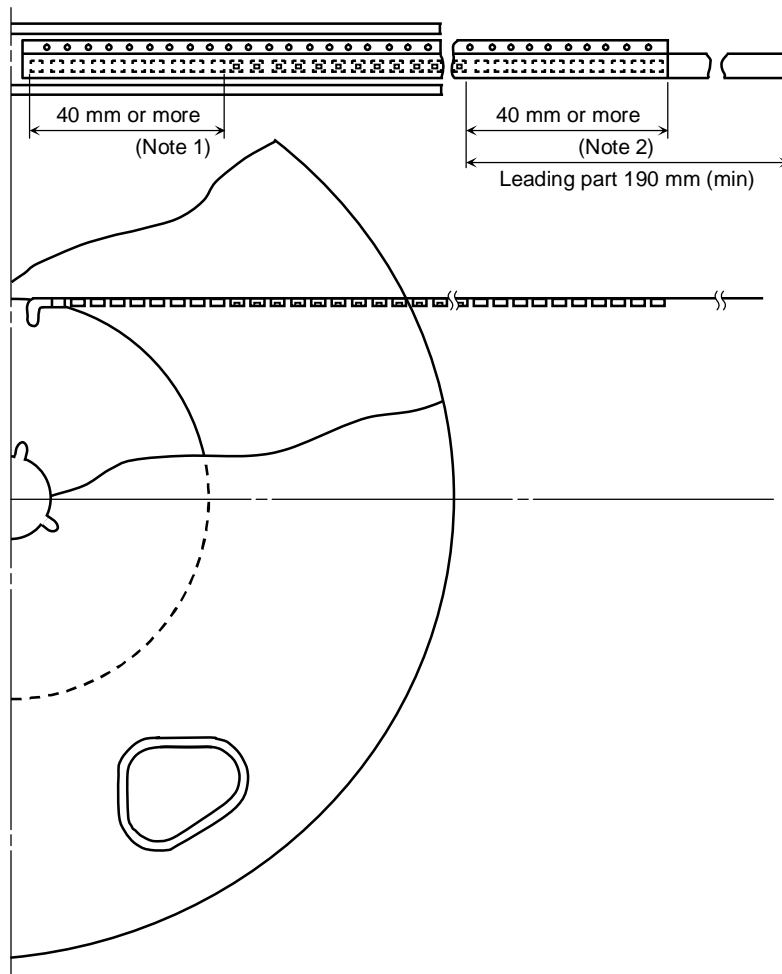

Note 1: Empty trailer section

Note 2: Empty leader section

## 6. Packing display

### (1) Packing quantity

Reel	4,000 pcs
Carton	20,000 pcs

(2) Package form: Each reel is sealed in an aluminum pack with silica gel.

## 7. Label format

### (1) Example: TLSV1022 (T14,F)

P/N:

TYPE	TLSV1022		
ADD.C	(T14,F)	QTY	4000 pcs

NOTE Lot Number

SEAL DATE:  
Lead(Pb) free

(RANK SYMBOL)

\*Y380xxxxxxxxxxxxxxxxx\*



2D barcode  
for TSB use

\* See below to decipher the Lot Number.

### (2) Label location

- Reel

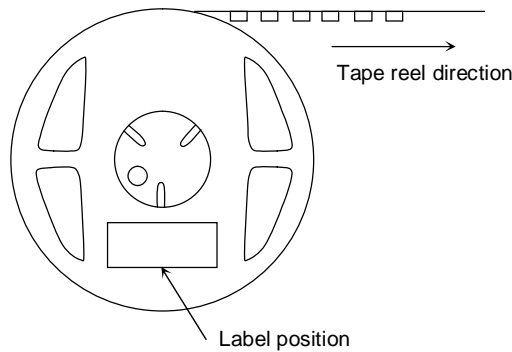

- Carton

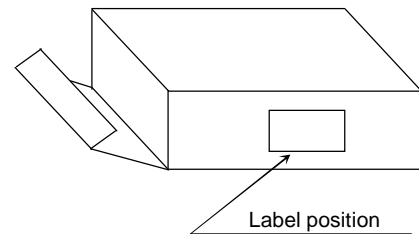

- The aluminum package in which the reel is supplied also has a copy of the label attached to center of one side.

\* Lot Number includes following information.

Example) 4 8 4 F 1 K ... Packaged in June 10th, 2004  
a b c d e

a: Domestic ID

b: Last one letter of A.D ...0(AD2000) , 1(AD2001) , 2(AD2002) , ~ 9(AD2009) Repeat for each decade.

c: Month ...A(Jan) , B(Feb) , C(Mar) , D(Apr) , ~ L(Dec)

d: Decade of a month ...1(Beginning) , 2(Middle) , 3(Last)

e: Date ...A(1st) , B(2nd) , C(3rd) , ~ J(9th) , K(10th) , L(31st) ("1" is an exception.)



**RESTRICTIONS ON PRODUCT USE**

030619EAC

- The information contained herein is subject to change without notice.
- The information contained herein is presented only as a guide for the applications of our products. No responsibility is assumed by TOSHIBA for any infringements of patents or other rights of the third parties which may result from its use. No license is granted by implication or otherwise under any patent or patent rights of TOSHIBA or others.
- TOSHIBA is continually working to improve the quality and reliability of its products. Nevertheless, semiconductor devices in general can malfunction or fail due to their inherent electrical sensitivity and vulnerability to physical stress. It is the responsibility of the buyer, when utilizing TOSHIBA products, to comply with the standards of safety in making a safe design for the entire system, and to avoid situations in which a malfunction or failure of such TOSHIBA products could cause loss of human life, bodily injury or damage to property.  
In developing your designs, please ensure that TOSHIBA products are used within specified operating ranges as set forth in the most recent TOSHIBA products specifications. Also, please keep in mind the precautions and conditions set forth in the "Handling Guide for Semiconductor Devices," or "TOSHIBA Semiconductor Reliability Handbook" etc..
- The TOSHIBA products listed in this document are intended for usage in general electronics applications (computer, personal equipment, office equipment, measuring equipment, industrial robotics, domestic appliances, etc.). These TOSHIBA products are neither intended nor warranted for usage in equipment that requires extraordinarily high quality and/or reliability or a malfunction or failure of which may cause loss of human life or bodily injury ("Unintended Usage"). Unintended Usage include atomic energy control instruments, airplane or spaceship instruments, transportation instruments, traffic signal instruments, combustion control instruments, medical instruments, all types of safety devices, etc.. Unintended Usage of TOSHIBA products listed in this document shall be made at the customer's own risk.
- TOSHIBA products should not be embedded to the downstream products which are prohibited to be produced and sold, under any law and regulations.
- GaAs(Gallium Arsenide) is used in this product. The dust or vapor is harmful to the human body. Do not break, cut, crush or dissolve chemically.

## X-ON Electronics

Largest Supplier of Electrical and Electronic Components

*Click to view similar products for [Toshiba manufacturer](#):*

Other Similar products are found below :

[TLP624-4F](#) [HDEPR01GEA51](#) [TB62218AFTG,8,EL](#) [TB6560AHQ\(O,8\)](#) [TORX1952\(6M,F\)](#) [TB62215AFTG,8,EL](#) [TC7SH02FU,LJ](#)  
[TC7WT125FU\(TE12L,F](#) [2SA1587-BL,LF](#) [TC7SBL384CFU,LF](#) [TLP183\(GB,E](#) [431392HB](#) [EMPP008Z](#) [TC58DVM92A5TA00](#)  
[TLP291\(TP,E\)](#) [TLP5214\(D4-TP,E](#) [TLP591B\(C,F\)](#) [TPC8120](#) [TLP352\(LF1,F\)](#) [TLP206A\(F\)](#) [TLP109\(TPR,E\)](#) [TK16A60W,S4VX](#)  
[TC4013BP\(N,F](#) [TBD62503AFNG,EL](#) [TCK112G,LF](#) [TLP185\(GR-TPL,E\(O](#) [TLP185\(GB-TPR,E\(O](#) [TLP3906\(TPR,E\(O](#) [VFNC3S-2002PL](#)  
[VFNC3S-2015PL](#) [TLP7820\(D4-A,E](#) [SSM3J35AMFV,L3F](#) [SSM3J14T](#) [TCK22971G,LF](#) [THGBMDG5D1LBAIL](#) [TLP3214\(TP15,F\)](#)  
[058399HB](#) [TORX177F,T](#) [TLP190B\(U,C,F\)](#) [VFS15S-2015PL-W](#) [TB6560AFG,8](#) [TK39N60W5,S1VF](#) [TLP5754\(D4,E](#) [TC7W14FUTE12LF](#)  
[AB3X2X3W](#) [TB6560AFG\(O,8\)](#) [TB6568KQ\(O,8\)](#) [TLP185\(GR.E\(O](#) [74HC138D](#) [SW89CN0-ZCC](#)