







635 & 636 Series AC Hour Meters (ETI's)

-  24, 115, 220 VAC Operating voltage
-  Continuous duty, rugged design
-  Tamper resistant
-  Permanently lubricated
-  6 Figure display: 99999.9
-  Round or Square bezel mounting
-  UL/cUL Approved



Square Style "Y" Bezel
Model #635 Non-resettable



Round Style "X" Bezel
Model #636 Resettable

Cramer AC Hour Meters can be found in these applications and more:



CNC Machine Tools



Waste Water Treatment



Construction Equipment



Control Panels

635 & 636 Series AC Hour Meters (ETI's)

Applications

CNC Machine Tools



Construction Equipment



Waste Water Treatment

Control Panels



Dimensions



Model #635 Non-resettable Round & Square Bezel



Model #636 Resettable Round & Square Bezel



Most Popular Configurations

Model # 635		
Part #	Bezel type	Time Registration
10055	Round	HRS/TEN 115/60
10063	Square	HRS/TEN 115/60
10069	Round	MIN/TEN 115/60
10071	Round	HRS/TEN 115/60
10186	Square	HRS/TEN 115/60
30850	Square	HRS/TEN 115/60
Model # 636		
10072	Round	SEC/TEN 115/60
10074	Round	MIN/TEN 115/60
10075	Round	HRS/TEN 115/60
10080	Square	SEC/TEN 115/60
10083	Square	HRS/TEN 115/60
10086	Square	MIN/TEN 115/60

Additional configurations available.

Style "X" & "G" Bezel

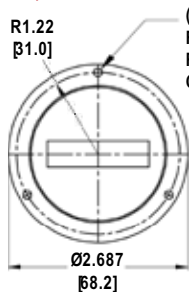

(3) HOLES EQ SPACED FOR #4 BINDING HD SCREWS. RECOMMENDED PANEL CUTOUT 2.22" [56.4] DIA.
Note: Style "G" Bezel is attached to housing

Bezel Styles

Style "Y" & "K" Bezel

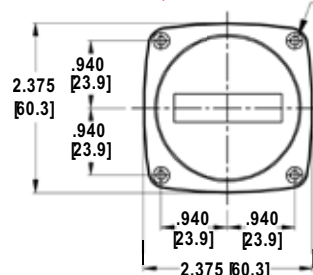

(4) HOLES FOR #4 PHILLIPS HD SCREWS. RECOMMENDED PANEL CUTOUT 2.22" [56.4] DIA.
Note: Style "K" Bezel is attached to housing

Style "E" Bezel

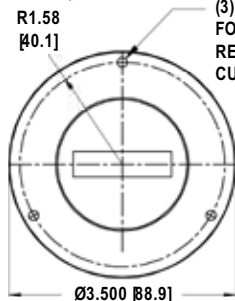

(3) HOLES EQ SPACED FOR #6 BINDING HD SCREWS. RECOMMENDED PANEL CUTOUT 2.82" [71.6] DIA.

Style "S" Bezel

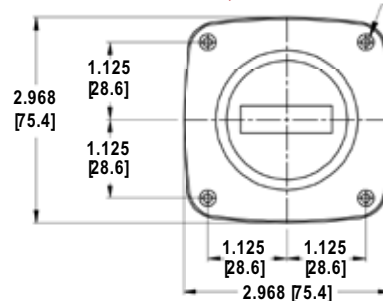

(4) HOLES FOR #4 PHILLIPS HD SCREWS.

Specifications

Model	635	636
Display	6 Figure; 99999.9	
Time Registration	Minutes or Hours (Seconds Special Order)	Seconds, Minutes or Hours
Resettable	Not available	Push button
Motor Specification	24, 115, 220 VAC; 50 or 60hz	
Power	2.7 Watts	
Operating Temperature Range	-4°F to 131°F (-20°C to 55°C)	
Electrical Connection	6" (15 mm) Leads, 22 gauge wire	
Front Panel Mounting	3 hole Round, 4 hole Square	
Agency Approval	UL/cUL	

Options

- Bezel Style: E, X, S, or Y
- Resettable to "zero"
- Non-resettable: Recommended when tamper proofing is required to record total "on time"

www.mhrhodes.com



M.H. Rhodes Cramer Company
105 Nutmeg Road South • South Windsor, CT 06074 USA
Toll Free: 877.684.6464 • PH: 860.291.8402 • FX: 860.610.0897

X-ON Electronics

Largest Supplier of Electrical and Electronic Components

Click to view similar products for [MARKTIME](#) manufacturer:

Other Similar products are found below :

[10186](#)