

Instruction Manual (COB LED Package)



CONTENTS

| | |
|----------------------------------|------|
| 1. Product Description | P.2 |
| 2. Handling The COB LED Packages | P.3 |
| 3. Soldering Process | P.7 |
| 4. Mechanical Assembly | P.9 |
| 5. Thermal Design | P.12 |
| 6. Electrical Connection | P.13 |
| 7. Chemical Incompatibility | P.16 |
| 8. Solutions | P.17 |

CITIZEN ELECTRONICS CO., LTD.

1-23-1, Kamikurechi, Fujiyoshida-shi, Yamanashi, 403-0001, Japan Tel. +81-555-23-4121 <http://ce.citizen.co.jp>
Copyright © 2014 CITIZEN ELECTRONICS CO., LTD. All Rights reserved.

Ref.CE-P2468 03/13_R3(0514)

1. Product Description

1-1. Introduction

Citizen Electronics seeks the highest level of brightness and efficacy in the LED package industry. In addition, we have endeavored to achieve technical solutions for many years. Through our advanced manufacturing technique and packaging technology, Citizen Electronics COB LED package series products will bring you a lighting space full of delight and beauty.

Citizen Electronics' COB LED Package series delivers "A world's best lumen performance and efficacy", "High reliability and long service life based on proven data by actual measurement", "Extensive product lineup". This application note provides recommendations for handling, soldering, mechanical assembly, thermal design, electrical connection, chemical incompatibility, solutions.

1-2. Product description of COB LED Package

The mechanical feature of the COB LED package series shows in Figure 1. COB LED package has Anode (positive electrode) and Cathode (negative electrode) on the aluminum board. The resin area is composed of mounting LED dies on the aluminum board and enclosing them with silicone resin which includes a fluorescent substance. In addition it is possible for COB LED package to be assembled in the heatsink directly, though it is not possible with the SMD type of LED package. Therefore it is not

necessary to use the mounting flow and printed circuit board. The COB LED package has high thermal dissipation performance by mounting LED dies directly on the aluminum board.

The COB LED package series makes it possible to design the LED light fixture smaller. Example applications for using the COB LED package fixture are street lights, down lights, spot lights, and bulbs.

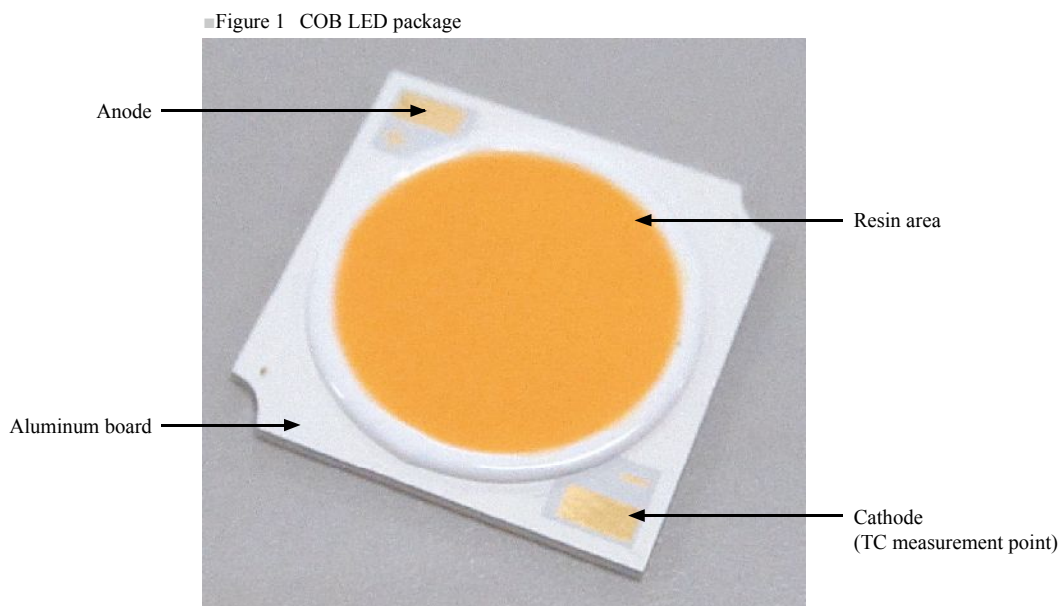

2. Handling The COB LED Packages

2-1. Precautions for removal from the tray

The COB LED package series is supplied in packing trays which made from electrically conductive polystyrene. (Figure 2) Please be aware to hold the edge part of the tray and transport. (Figure 3) If force is applied to the resin area inside of the tray, the bottom surface of the tray may press the resin area and have negative impact the functions, performance and reliability of these products on.

■Figure 2 Appearance of the packing tray



The packing tray is designed to be stackable without contact or pressing this product, in cases where trays are stacked in the same direction by matching the reference surface. (Figure 4) Please open the tray on a flat surface and treat the LED package in a clean environment avoiding dust and particles, which may adhere to the resin area of the LED package.

In the case where the reference surface is set on the left bottom side, the direction of LED package(cathode and

■Figure 4 The package part of the packing tray

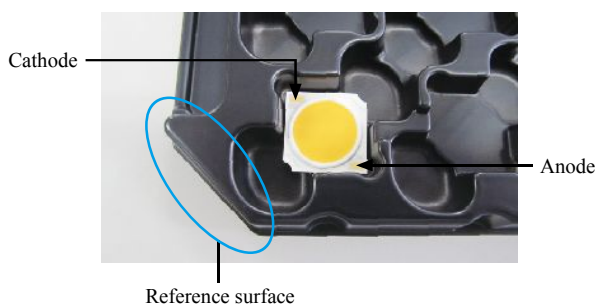

■Figure 3 Method of transporting the tray

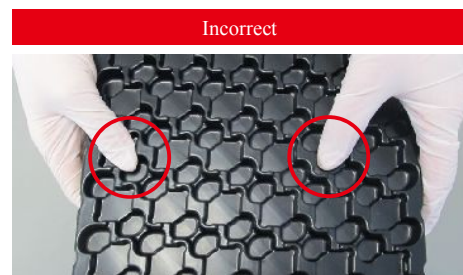
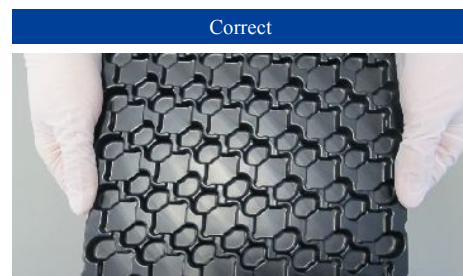

❌ Don't push the tray

Anode electrical pad) is located as in Figure 4.

It is strongly recommended to use antistatic gloves for removal from the packing tray, and not to handle by naked fingers. (Figure 5) In addition, please avoid using sharp objects such as tweezers to pick up on hold of LED packages, because they may result in disconnection of the wire inside of the resin area, and this may cause the light to stop functioning.

■Figure 5 The recommended way to handle the product



2-2. Method of handling the product

Please be aware to avoid placing mechanical stress on the LED package especially the resin area. It may cause LED light to stop functioning.

Please handle the LED package with care. It is recommended to wear antistatic gloves to prevent dirt or other contaminants from adhering to the resin area. They may have a negative impact on the optical performance of the

LED package. Please ensure that no objects attach or put pressure the resin area.

Please do not use sharp objects like tweezers to pick up or hold LED packages. The wire inside of the resin part may be disconnection and it may cause the light to stop functioning.

The recommended handling method is shown in Figure 6.

■Figure 6 Recommended handling method

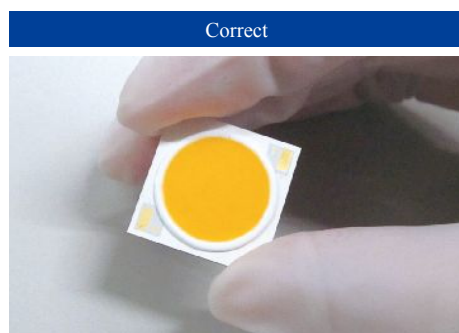

Strongly recommended
to use antistatic gloves

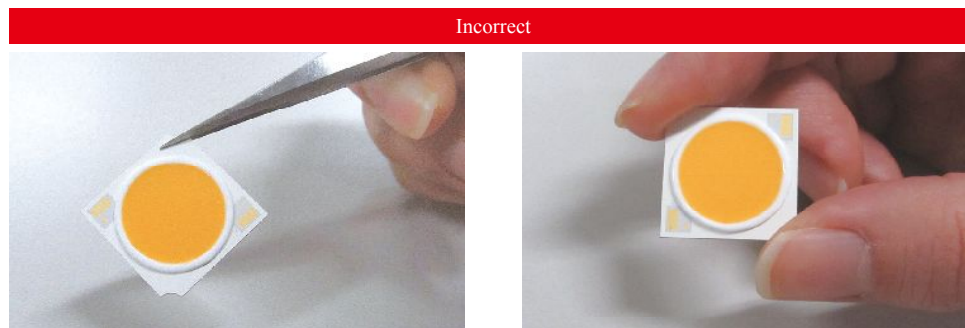

❌ Do not use tweezers

❌ Do not touch with naked fingers

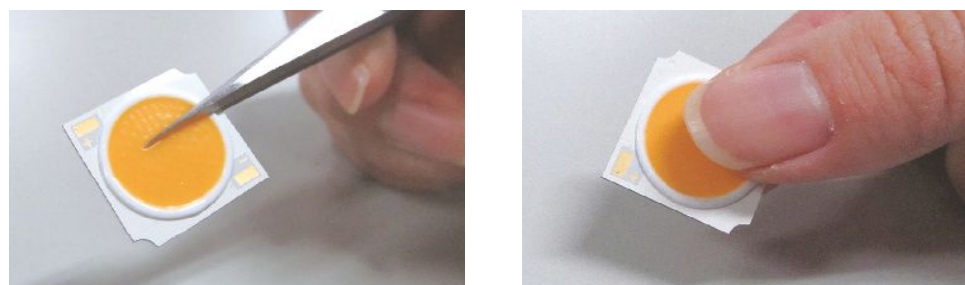

❌ Do not touch the resin area

❌ Do not touch the resin area

2-3. Precautions for handling

i) The resin part is composed of the light emitting area and white dam area. Please avoid use of anything sharp (Figure 7) to press, put stress on, rub, attach or make contact with the resin. They might negatively affect the function, performance and reliability of this product.

■Figure 7 Pressure on the resin area is not approved

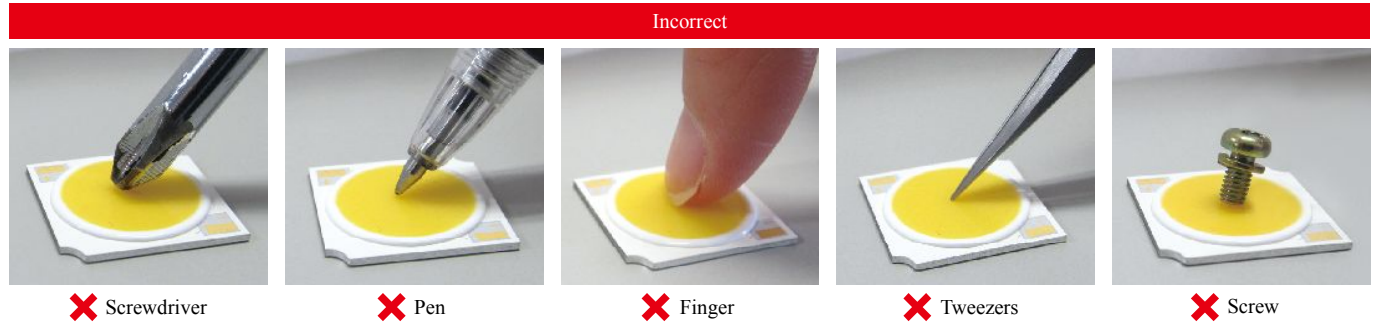

ii) Please make sure the resin area should not be attached and contact by any other parts during assembly process. (Figure 8)

■Figure 8 Contact between the resin area and other parts is not approved

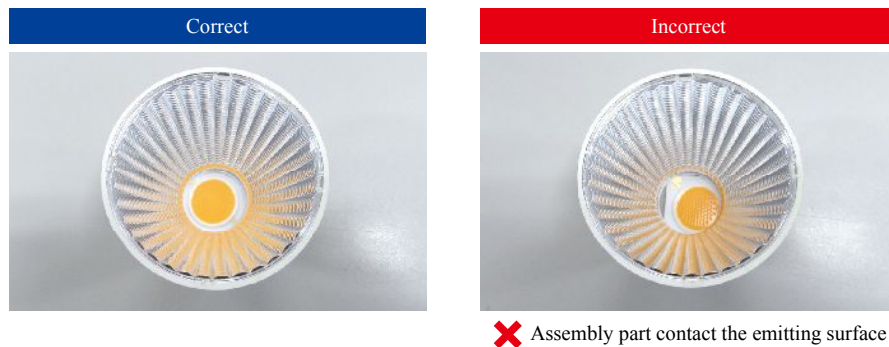

iii) Please do not stack this product. It might damage the LED package resulting in peeling, cracking, or wires becoming disconnected. (Figure 9)

■Figure 9 Incorrect stacking of LED packages

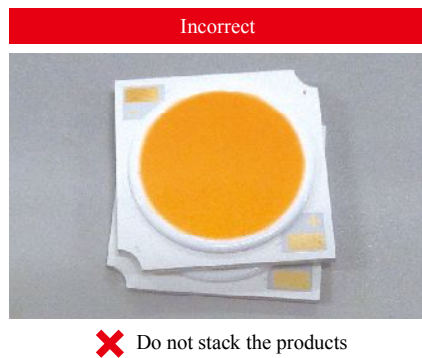

2-4. Precautions for handling after soldered the lead wire

2-4-1. Method of handling the product

Please do not pick up or hold the lead wire after soldered the lead wire. It might negatively affect the function, performance and reliability of this product. (Figure 10) In addition when handling the product which soldered the lead wire, please pick up and hold side of the products and do not touch the lead wire.

■Figure 10 Recommended handling method

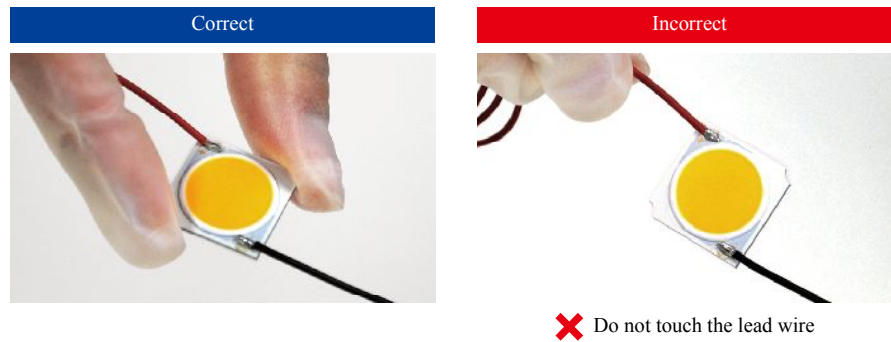

2-4-2. Precautions for handling the lead wire

Please don't handle the lead wire as in the list below. It might negatively affect the function, performance and reliability. (Figure 11)

1. Please do not bend the lead wire perpendicularly
2. Please do not twist the lead wire
3. Please do not pull the lead wire
4. Please do not swing the product with holding the lead wire
5. Please do not cause damage to the lead wire

■Figure 11 Handling the lead wire is not approved

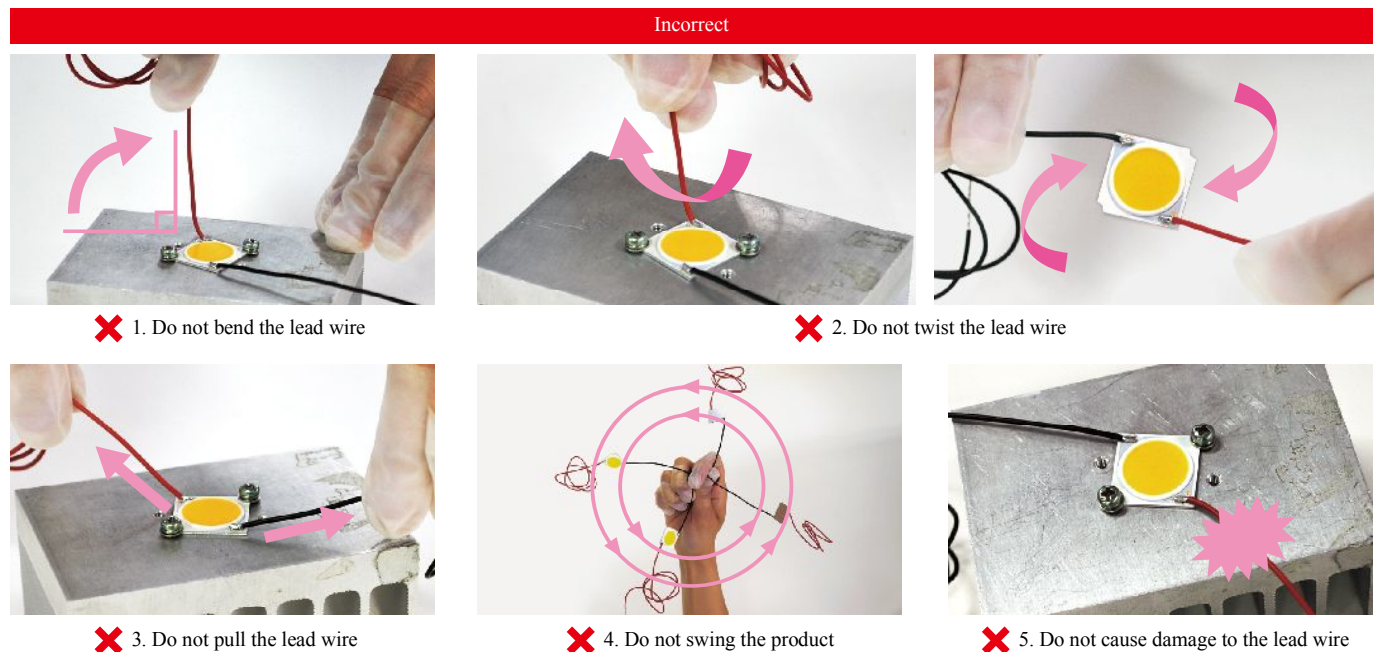

3. Soldering Process

3-1. Recommended soldering process

This product is not adaptable to reflow process. The conditions below are recommended for soldering.

Recommended soldering conditions

Output of soldering iron :

Soldering bit temperature shall be 350°C or less

Heating time : 3.5 seconds or less per land

Contacts number of soldering bit : within 2 times

3-2. Precautions for soldering

i) No external force shall be applied to the resin area. In addition, please ensure that the soldering bit has no contact with the resin area. (Figure 12)

■ Figure 12 Precautions for soldering

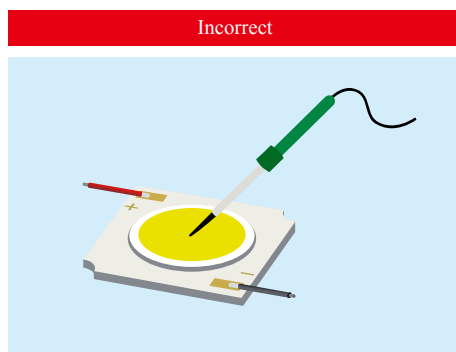

❌ Do not touch the resin area

ii) Please do not push the pad with the soldering bit, when the soldering bit heat it. (Figure 13)

■ Figure 13 Precautions for soldering

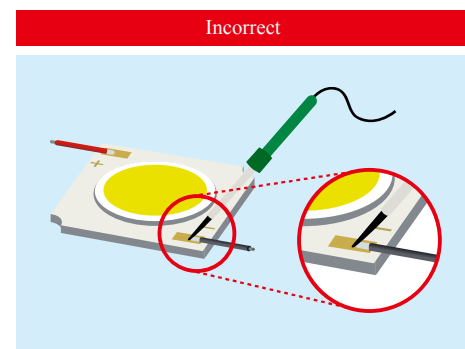

❌ Do not push the pad with the soldering bit

iii) Next process of soldering should be carried out after the product has returned to ambient temperature. (Figure 14)

■ Figure 14 Precautions for soldering

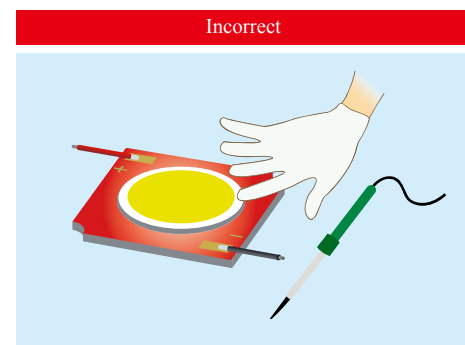

❌ Be careful for the heat

3-3. Recommended soldering appearance

3-3-1. Appearance of soldering lead wire

Please ensure the following are carried out.

Recommended Appearance of soldering lead wire

1. The soldering fillet is formed.
2. The core part is soldered well.
3. The solder has a shiny appearance.
4. There is no protuberance or extremely raised on the soldering.
5. The lead wire does not float up from the pad.
6. The solder covers well the outside and the side surface of lead wire.
7. There is no soldering attached (e.g. soldering ball, soldering flux) at outside the designated pad for soldering.
8. The solder lands on 2/3 space of pad of LED package board.
9. The conductive part of lead wire doesn't land on the outside of the soldering pad.
10. The height of the conductive part of lead wire and the soldering do not exceed the height of the insulated plastic part.

3-3-2. Position of soldering lead wire on the soldering pad

Please refer to the positioning between the lead wire and the soldering pad in the pictures below.(Figure 15) Please solder the lead wire correctly, It might negatively affect the function, performance and reliability of this product.

Figure 15 Method for soldering lead wire

Correct

Does not extend over the conductive part of wire from soldering pad

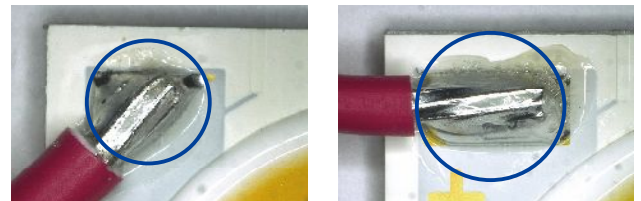

Incorrect

✗ The conductive part of wire extends over soldering pad



✗ Over at front edge

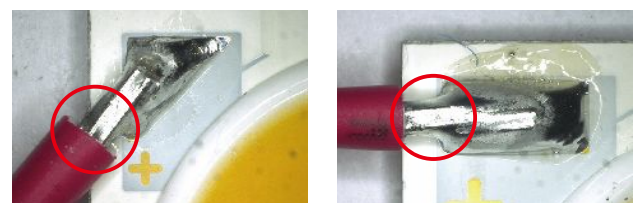

✗ Over at bottom edge

4. Mechanical Assembly

4-1-1. Reference assembly 1: M3 Screw, Thermal conductivity two-sided adhesive sheet

Regarding assembly of the COB LED package CLL020, CLL022, CLU024, CLL030, CLL032, CLU034, CLL040, CLL042, CLU044, CLL050, CLL052, CLU054, CL-L100 series it is possible to attach a heatsink directly with M3 screw by using TIM (thermal interface material). A reference assembly of a lighting system is shown in Figure 16.

It may be applied to mounting screws 0.6 Newton meters. Please follow the position information in Figure 17 for fixture with M3 screws. It is strongly recommended to tighten screws on heatsink a second time. At first fix each side's screw temporarily, and then tighten them finally in order not to place too much over power of stress on the LED package.

In order to reduce the thermal resistance at assembly, please use TIM on the whole contact surface of the

product. When using thermal grease as the TIM, it is recommend to apply it uniformly on the contact surface of the product. When using a thermal sheet as the TIM, it is recommend to make sure that the product is not strained by stress when the screws are tightened for assembly.

In addition, regarding assembly of the COB LED packages CLL010, CLL012, please use the thermal conductivity two-sided adhesive sheet attach on the heatsink. As a reference, we offer the information of TC-20SAS (Shin-Etsu Chemical Co., Ltd.).

A dielectric voltage withstand test has been conducted on this product to identify any failure after applying voltage between active pads and aluminum section of the product, and to pass at least 500V. Please confirm the electrical safety of your final product.

■Figure 16 Reference assembly for fixing with M3 screws

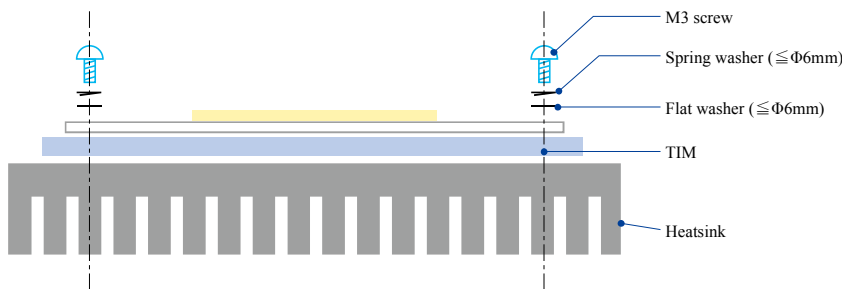

■Figure 17 Recommended screw location and pitch

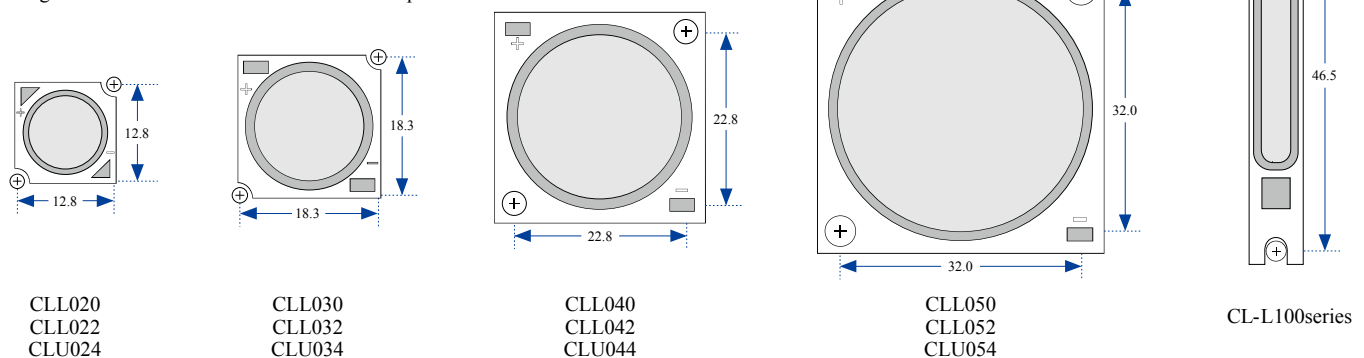

4-1-2. Reference assembly 2: Connector

A reference assembly of a lighting system using COB LED package is shown in Figures 18 and 19. Connector, COB LED package, TIM, Heatsink are assembled as in Figure 18. Please use TIM for better heat dissipation. There is information about the recommended connector for “8, Solutions” in the application notes. Please follow the specifications for each maker’s connector.

■Figure 18 Reference assembly

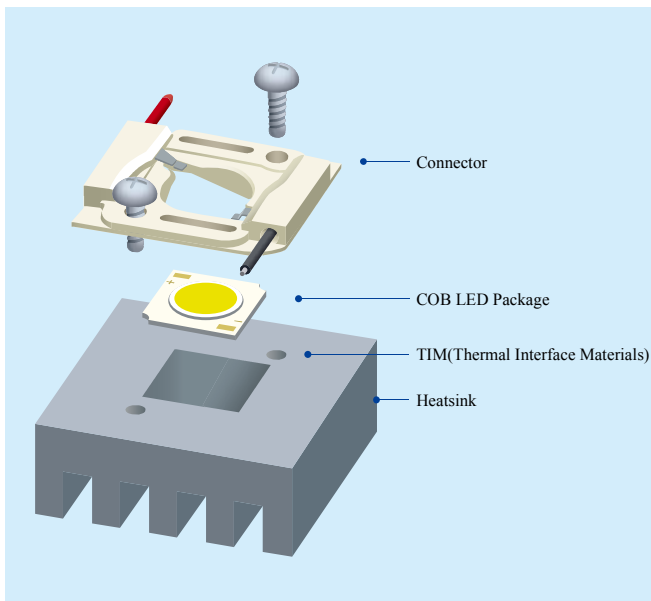

■Figure 19 Assembly image

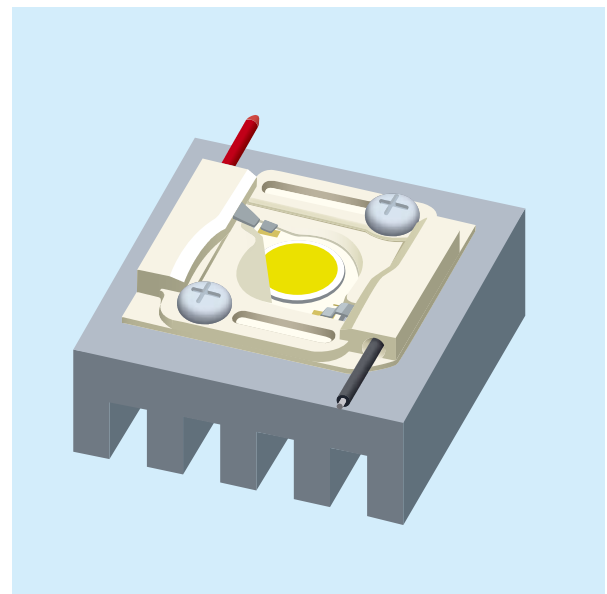

4-2. Precautions for assembly

i) Please ensure contact of the resin area with the COB LED package during assembly. Please do not use sharp objects especially fingers, screws, screwdrivers, pens to pickup or hold the LED package. The wire inside of the resin area may be become disconnected and cause the light to stop functioning. (Figure 20)

■Figure 20 Use of sharp objects is not approved

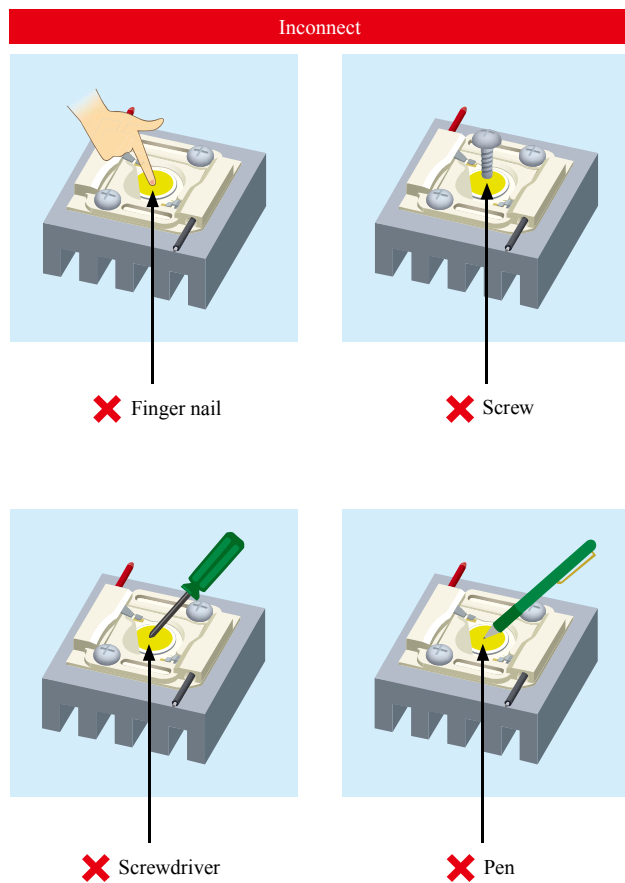

ii) When assembling, please use the correct method which is detailed in the specifications of each product. Also please do not attach the product by excessive torque or stress on the product. (Figure 21)

■Figure 21 Excessive stress torque are detrimental

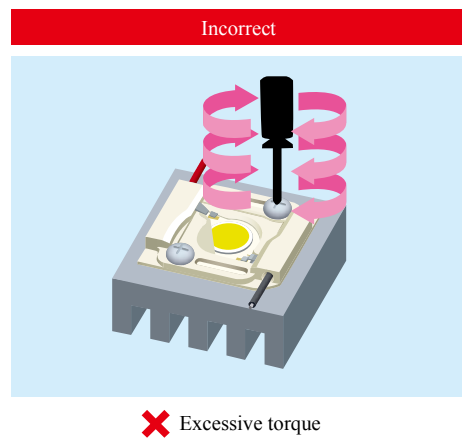

iii) Please assemble the correctly and do not touch the resin area with any other parts during assembly of the product. (Figure 22)

■Figure 22 Incorrect assembly

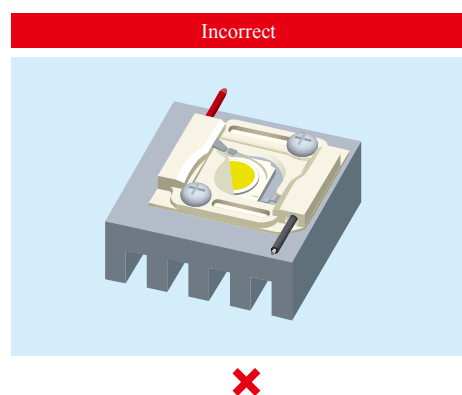

5. Thermal Design

5-1. Significance of the heat dissipation structure

An LED package radiates light and heat according to the input power. However, the surface area of an LED package is quite small, and the package itself is expected to release little heat into the atmosphere. An external radiator such as a heatsink is thus required. The heat dissipation structure up to the connection portion of the external radiator uses mainly heat conduction.

Regarding LED packages, to control the junction temperature of the LED dice T_j is important. The T_j must be kept from exceeding the absolute maximum rating in the specifications under any conditions. As direct measurement of the junction temperature of a LED dice inside a package is difficult, the temperature of a particular part on the

external package (the case temperature) T_c [°C] is normally measured. T_j [°C] is calculated using the thermal resistance between the junction and the case R_{j-c} [°C/W], and the input power P_i [W] considered as the emitted heat amount. The heat generated at the LED dice can be conducted to the external radiator efficiently because the package structure for the COB LED package minimizes the thermal resistance R_{j-c} .

This document describes the detailed heat dissipation structure of the COB LED package and provides data necessary for thermal design of the lighting apparatus to maximize performance.

5-2. Package structure and thermal resistance

The cross-sectional structure example, where the COB LED package is connected to an external heatsink, is shown in Figure 23. The package has a laminated structure of an aluminum substrate, insulating layers and conductive copper foil pad.

A distinctive point is that the LED dice is mounted directly on the well conductive aluminum substrate not on the insulating layer, which has low thermal conductivity. Thus, the heat generated at the LED dice can be efficiently conducted to the outside of the package.

The aluminum substrate side of the package outer shell is thermally connected to the heatsink via TIM. As described above, the heat generated in the junction section of the LED dice is transferred mainly to the heatsink using heat conduction, through the LED dice to the adhesive for die-mounting to the aluminum substrate to the TIM. The thermal resistance between the junction section of the LED

dice and the aluminum substrate side of the package outer shell is R_{j-c} , and the specific thermal resistance value of the package. Therefore, the following formula is used:

$$T_j = R_{j-c} \cdot P_i + T_c$$

In addition, the thermal resistance of the TIM outside the package is R_{-TIM} [°C/W], the thermal resistance with the heatsink is R_h [°C/W], and the ambient temperature is T_a [°C].

Figure 24 indicates the equivalent thermal resistance along the cross-sectional diagram in Figure 23. As indicated, the thermal resistances R_{j-c} , R_{-TIM} , and R_h are connected in series between the junction temperature T_j and the ambient temperature T_a . The thermal resistances outside the package R_{-TIM} and R_h can be integrated into the thermal resistance R_{c-a} at this point. Thus, the following formula is also used:

$$T_j = (R_{j-c} + R_{c-a}) \cdot P_i + T_a$$

Figure 24
Thermal Resistance Connection

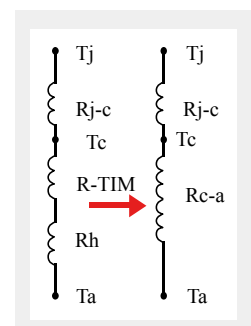
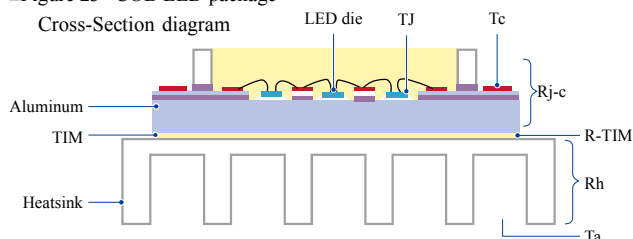

Figure 23 COB LED package



6. Electrical Connection

6-1. Introduction

Prior to driving an LED package, which is a kind of semiconductor, it is necessary to thoroughly comprehend its characteristics because it has various elements. For example, the forward current 'If' varies widely with fluctuation in the forward voltage 'Vf'. In the case of Figure 25, a 10% rise in Vf results in an increase of If by more than 40% under constant temperature conditions. The fluctuations in If have a significant influence on light emission and heat generation of LED packages. Especially, strict control of If is required for high-power LED packages used for lighting because they are driven by large current. In addition, the measures taken against heat release by an LED package are a crucial factor as Vf varies with temperature. When driving our LED packages, please be sure to read the relevant specifications and application notes and take appropriate measures according to their characteristics.

■ Figure 25 Vf-If characteristic

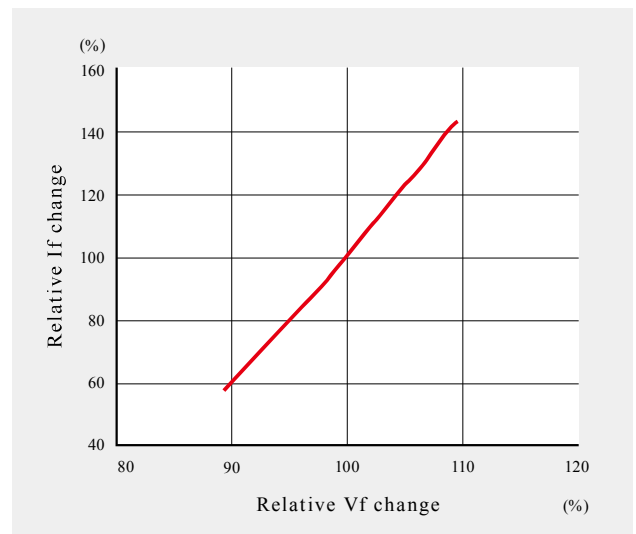

6-2. Constant current drive system (recommended)

The system that continues to supply a certain current to an LED package even under the conditions that Vf varies with heat generation or other factors is said to be a 'constant current drive system'. This system allows relatively stable driving of LED packages even under changing environmental conditions or other parameters.

In general, an LED package has a tendency for Vf, which applies a certain current to an LED package, to decrease as the temperature increases. (Figure 26)

Citizen Electronics recommends the constant current drive system to ensure stable light emitting output and reliability.

■ Figure 26 Tc-Vf characteristic

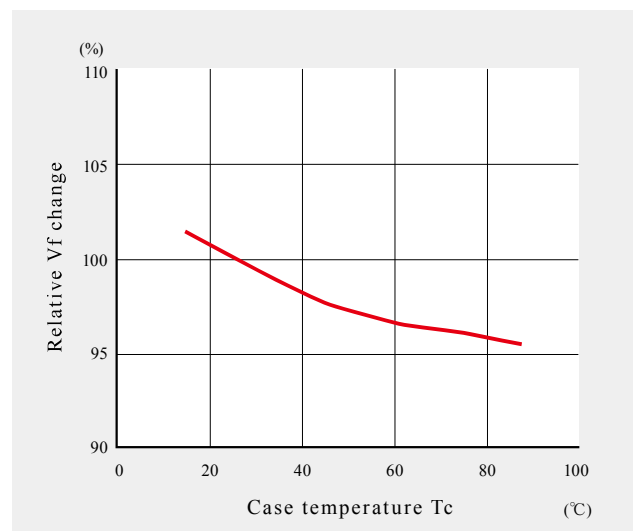

6-3. Constant voltage drive system

Whereas the constant current drive system continues to supply a certain current to an LED package, the system that continues supplying a certain voltage to an LED package is said to be a ‘constant voltage drive system’. As described above, an LED package has a tendency for V_f , which applies a certain current to an LED package, to decrease as the temperature increases. In the case of Figure26, when the case temperature T_c is 90°C, the same amount of current is achieved by approximately 5% lower V_f than that of the condition in which T_c is 25°C. From another perspective, when an LED package is operated with a certain voltage, the more the temperature increases, the larger the current that flows through the LED package. In cases of driving with a constant voltage, as shown in Figure27, temperature changes lead to changes in V_f and current as the temperature of an LED package is unstable due to variance in environmental temperature or other factors. Accordingly, the brightness of an LED package can be unstable as it depends on current. Thus, when driving with a constant voltage is employed, an appropriate measure such as the connection of current control resistance needs to be implemented based on an assumption of the temperature in actual use.

■Figure 27 Instability due to driving with constant current

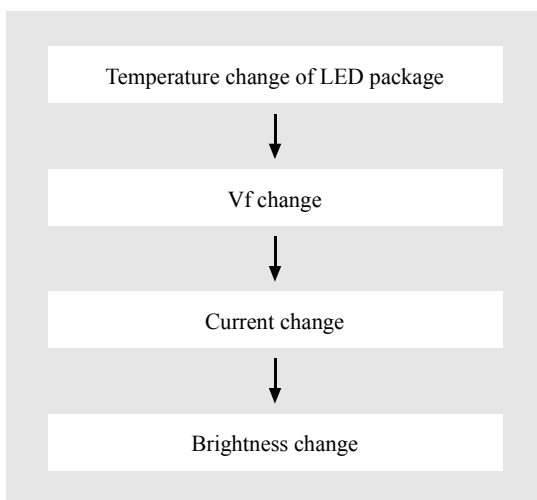

6-4. Precautions for inrush current

When an LED package is connected to capacitive load such as a capacitor, instantaneous inrush current may occur during on/off operations. For instance, this includes the case where the second side of energized power circuit is turned on/off. Citizen Electronics recommends usage that avoids the occurrence of inrush current as much as possible. In cases where the occurrence of inrush current is unavoidable, please be sure to take measures to prevent exceeding the absolute maximum rating of the relevant LED package.

6-5. Connection between multiple LED packages

When connecting multiple identical LED package products, the series connection makes current flowing through LED packages uniform. Citizen Electronics recommends series connection to ensure stable light-emitting output and reliability. On the other hand, a parallel connection should be considered for V_f variation between LED packages. Some measures, such as the appropriate current regulation resistor being connected to each LED package in series based on the temperature conditions in actual use, are required to apply even current to each LED package with different V_f characteristics.

6-6. A parallel connection of LED packages

The method for using n LED packages with the parallel connection is explained below.

6-6-1. Use of a constant current drive system

Method to prepare the constant current circuit for each LED package line.(Figure 28)

■Figure 28

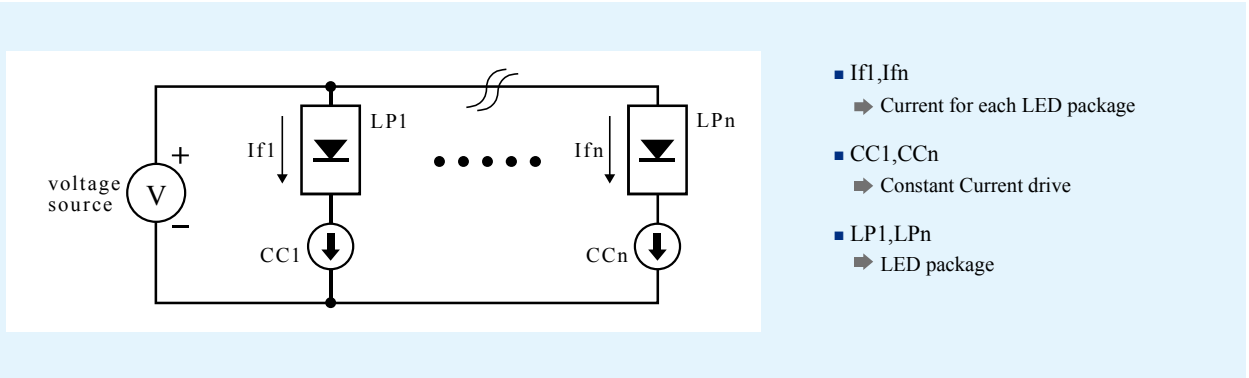

6-6-2. Use of current-limiting resistor

The equivalence circuit in the case setting current-limiting resistor for each LED package line.(Figure 29)

■Figure 29

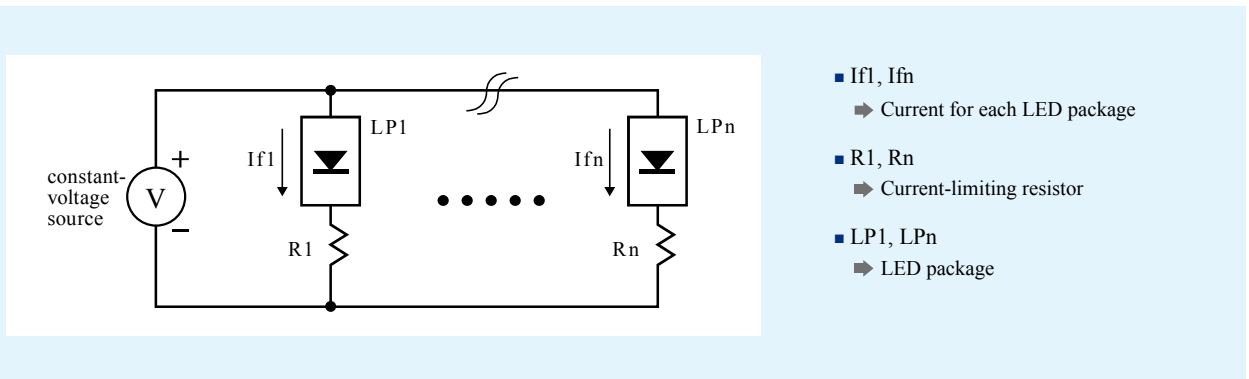

7. Chemical Incompatibility

The LED package contains a silicone to protect the LED dies and the silicone is gas permeable. Some VOCs (volatile organic compound) and chemicals will cause discoloration, surface damage, cracking or erosion. Table 1 shows the list of harmful materials which will damage the silicone. Please do not use them together with the LED package. If it is necessary to use them together, please test them before use.

■ Table 1 List of harmful materials that will damage the silicone.

| ~ Chemical Name ~ |
|--|
| hydrochloric acid |
| sulfuric acid |
| nitric acid |
| acetic acid |
| sodium hydroxide |
| potassium hydroxide |
| ammonia |
| MEK (Methyl Ethyl Ketone) |
| MIBK (Methyl Isobutyl Ketone) |
| Toluene |
| Xylene |
| Benzene |
| gasoline |
| mineral spirits |
| dichloromethane |
| tetrachloromethane |
| castor oil |
| lard |
| linseed oil |
| petroleum |
| silicone oil |
| halogenated hydrocarbons (containing F, Cl, Br elements) |
| rosin flux |

8. Solutions

The short list below shows some commercially available design resources. Citizen Electronics has introduced a variety of solutions (optical solutions, thermal solutions, electrical solutions, electrical devices, connectors, sockets) that may be used to handle and assemble Citizen Electronics LED packages by approved or qualified suppliers for customers convenience. It is the responsibility of the customer to fully qualify and validate luminaire design components and assembly processes to meet all code and regulatory requirements. Please refer to the URL site below. The information contained in URL is subject to change without notice.

Top page of solution information

[URL http://ce.citizen.co.jp/lighting_led/en/technology/solutions/index.html](http://ce.citizen.co.jp/lighting_led/en/technology/solutions/index.html)

Optical solutions

Introducing manufacturers who provide lenses, reflectors or holders for our LED packages.

[URL http://ce.citizen.co.jp/lighting_led/en/technology/solutions/lens.html](http://ce.citizen.co.jp/lighting_led/en/technology/solutions/lens.html)



Thermal solutions

Introducing manufacturers who provide heatsinks, thermal interface materials for our LED packages.

[URL http://ce.citizen.co.jp/lighting_led/en/technology/solutions/heat.html](http://ce.citizen.co.jp/lighting_led/en/technology/solutions/heat.html)

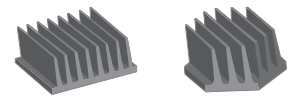

Electrical solutions

Introducing manufacturers who provide power supplies, drivers for our LED packages.

[URL http://ce.citizen.co.jp/lighting_led/en/technology/solutions/power.html](http://ce.citizen.co.jp/lighting_led/en/technology/solutions/power.html)

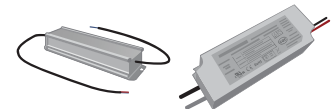

Electronic devices

Introducing manufacturers who provide electronic devices for our LED packages.

[URL http://ce.citizen.co.jp/lighting_led/en/technology/solutions/device.html](http://ce.citizen.co.jp/lighting_led/en/technology/solutions/device.html)

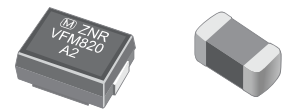

Connectors

Introducing manufacturers who provide connectors for our LED packages.

[URL http://ce.citizen.co.jp/lighting_led/en/technology/solutions/connector.html](http://ce.citizen.co.jp/lighting_led/en/technology/solutions/connector.html)

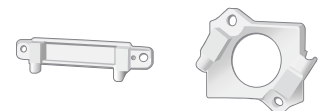

Sockets

Introducing manufacturers who provide sockets for our LED packages.

[URL http://ce.citizen.co.jp/lighting_led/en/technology/solutions/socket.html](http://ce.citizen.co.jp/lighting_led/en/technology/solutions/socket.html)



- CITIZEN ELECTRONICS CO., LTD. shall not be liable for any disadvantages or damage resulting from the use of technical information or data included in this document or the impossibility of download and use, responsibility for the cause of lawsuits or any other damages or losses.
- This technical information or data shall be provided 'as is' to users and CITIZEN ELECTRONICS CO., LTD. does not guarantee the absence of error or other defects in this technical information or data, conformance of this technical information or data to specific purpose, this technical information or data or its use will not infringe the rights of users or third parties or any other content.
- CITIZEN ELECTRONICS CO., LTD. reserves the right to make changes to technical information or data without notification.

Information contained in this document such as sentences, photographs and images is subject to copyright, and is protected by law. Unless it is for "duplication for private use" or "quotation" under copyright law, any duplication or diversion of this information without permission of CITIZEN ELECTRONICS CO., LTD. is prohibited by law.



CITIZEN ELECTRONICS CO., LTD.

1-23-1, Kamikurechi, Fujiyoshida-shi, Yamanashi, 403-0001, Japan
Tel. +81-555-23-4121
<http://ce.citizen.co.jp>

Requests / Inquiries
inquiry@ce.citizen.co.jp

Website for LEDs for lighting
http://ce.citizen.co.jp/lighting_led/jp/

X-ON Electronics

Largest Supplier of Electrical and Electronic Components

Click to view similar products for [High Power LEDs - White](#) category:

Click to view products by [CITIZEN](#) manufacturer:

Other Similar products are found below :

[G42180-08](#) [B42180-08](#) [STW8Q2PA-R5-HA](#) [SZ5-M1-W0-00-V3/W2-AA](#) [LTPL-P00DWS57](#) [LZP-D0WW00-0000](#) [CLM-9-30-90-36-AC32-F4-3](#)
[SZ5-M1-WW-C8-V1/V3-FA](#) [XHP50B-00-0000-0D0HJ240H](#) [BXRC-27E2000-D-73](#) [BXRC-27G2000-D-73](#) [BXRC-30E1000-D-73](#) [BXRC-30G2000-D-73](#) [BXRC-40E1000-D-73](#) [BXRE-30G2000-B-73](#) [BXRE-30G2000-C-73](#) [BXRE-50C2001-C-74](#) [CXM-22-27-80-54-AC30-F4-3](#) [XHP50B-00-0000-0D0UH245G](#) [XHP50B-00-0000-0D0UG227H](#) [XHP50B-00-0000-0D0HJ245G](#) [MP-5050-8100-27-80](#) [MP-5050-6100-65-80](#) [MP-5050-6100-50-80](#) [MP-5050-6100-40-80](#) [MP-5050-6100-30-80](#) [MP-3020-3100-65-80](#) [MP-3020-3100-40-90](#) [MP-3014-1100-40-80](#) [MP-3014-1100-35-80](#) [MP-3014-1100-30-80](#) [MP-3014-1100-27-80](#) [CXM-22-30-80-54-AC30-F4-3](#) [MP-3014-1100-57-70](#) [LTW-2835SZK57](#) [BXEM-50C0000-0-000](#) [WW-WNA30TS-U1\(M1\)](#) [KW CSLPM2.CC-8L8M-4L8N](#) [KW CSLPM2.CC-8L8M-4O9Q](#) [KW DPLS32.SB-6H6J-E5P7-EG-Z264](#) [L1V1-507003V500000](#)
[CXM-22-35-80-36-AC10-F3-3](#) [KW3 CGLNM1.TG-Z6QF6-EBVFFCBB46-DFGA](#) [GWCS8PM1.PM-LSLU-A232-1](#) [JB5630AWT-H-H65EA0000-NZ000001](#) [XHP50B-00-0000-0D0UG430H](#) [CXM-22-35-90-54-AC40-F5-3](#) [CXM-22-35-80-54-AC40-F5-3](#) [OSM51206E1N-0.8T](#) [OSM53535C1A-150MA](#)