

CP-series CP1E CPU Units

CP1E-E□□SD□-□ CP1E-N□□S□D-□-□

CP1E-E□□D□-□ CP1E-N□□D□-□/NA20D□-□

The CP1E Programmable Controller: Economical, Easy to use, and Efficient

- The E□□(S)-type Basic CPU Units provide cost performance and easy application with only basic functionality.
- The N□□(S□) and NA-types Application CPU Units support Programmable Terminal connection, position control, and inverter connection



CP1E-E20SDR-A



CP1E-N40S1DR-A

Features

- New CP1E CPU Units now available.
 - Lineup including CPU Units with built-in three ports: USB, RS-232C, RS-485.
 - The depth of CPU Units with RS-232C connectors is reduced by 20 mm. (N30/40/60S(1))
- Easy connection with computers using commercially available USB cables.
- With E30/40/60(S), N30/40/60(S□) or NA20 CPU Units, Add I/O, Analog I/O or Temperature Inputs by Connecting Expansion Units or Expansion I/O Units.
- Input interrupts
- Complete High-speed Counter Functionality.
- Versatile pulse control for Transistor Output for N14/20/30/40/60(S□) or NA20 CPU Units.
- PWM Outputs for Transistor Output for N14/20/30/40/60(S□) or NA20 CPU Units.
- Mounting Serial Option Boards, Ethernet Option Board and Analog Option Board to N30/40/60 or NA20 CPU Units.
- Built-in analog I/O, two inputs and one output, for NA-type CPU Units.

Windows is a registered trademark of Microsoft Corporation in the United States and other countries.

Other company names and product names in this document are the trademarks or registered trademarks of their respective companies.

The product photographs and figures that are used in this catalog may vary somewhat from the actual products.

CP1E-E□□(S)D□-□ CP1E-N□□(S□)D□-□/NA20D□-□

System Configuration

Basic Model

Basic System Configuration Using an E□□S-type CPU Unit

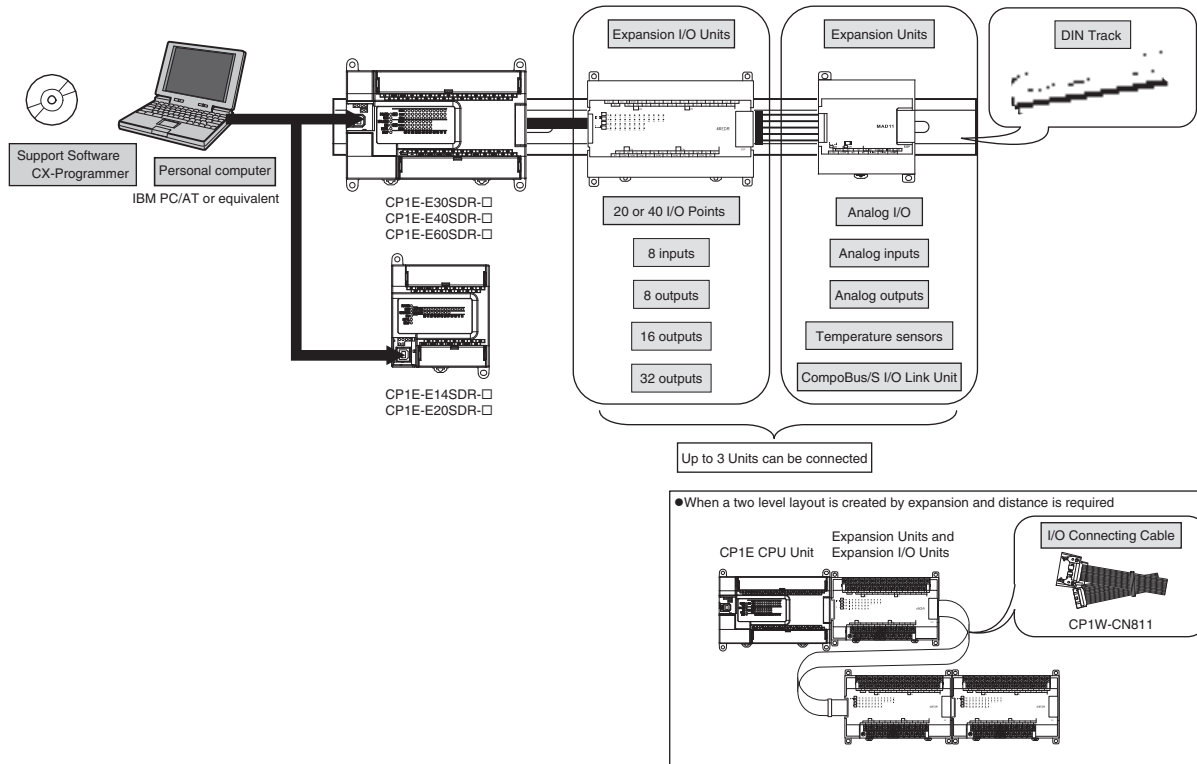

Basic System Configuration Using an E□□-type CPU Unit

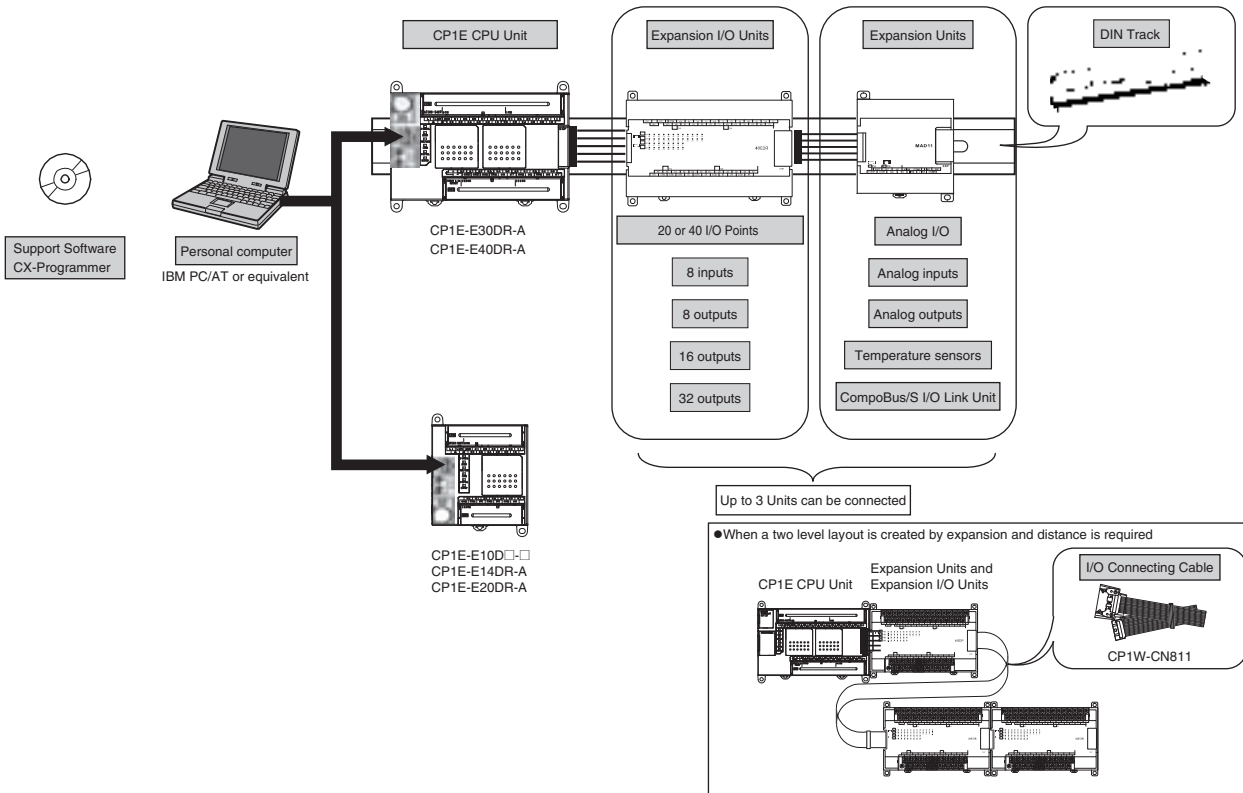

Application Model

Basic System Configuration Using an N/NA□□S(1)-type CPU Unit

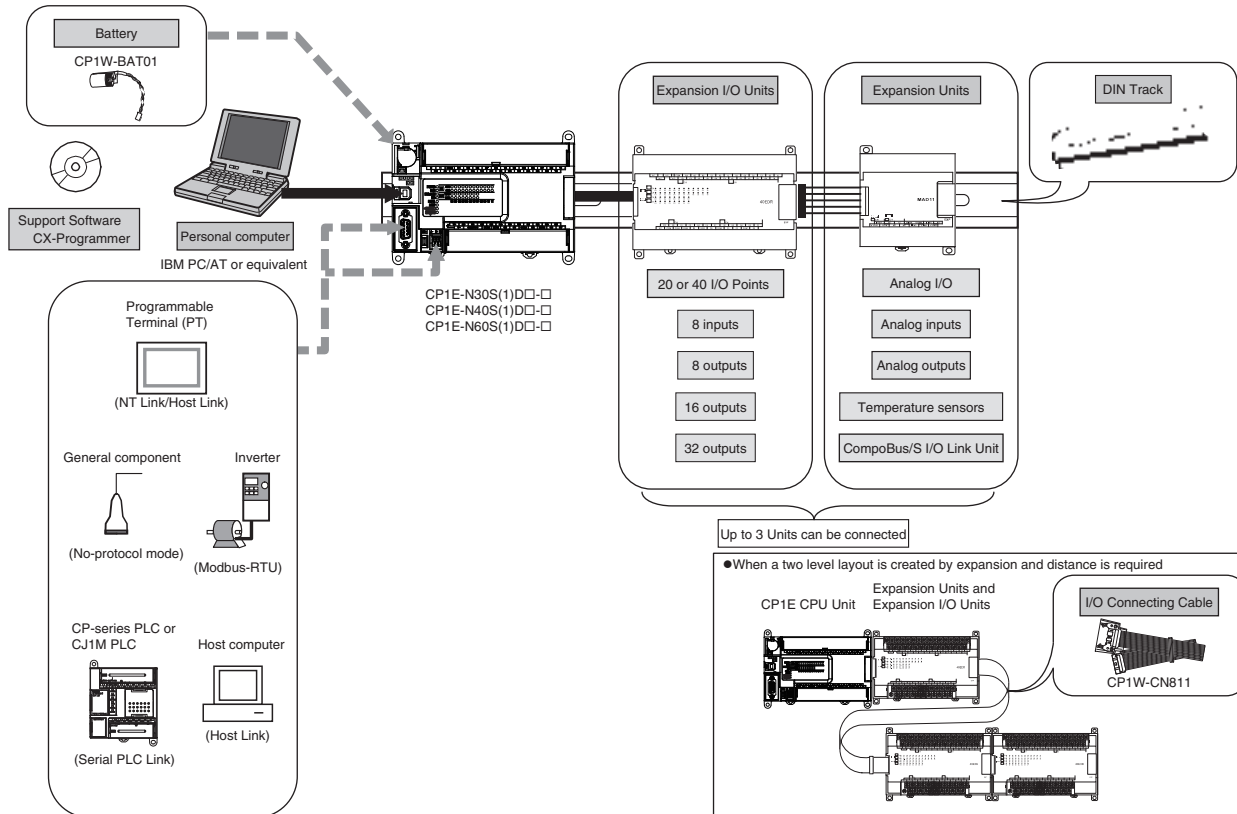

Basic System Configuration Using an N/NA-type CPU Unit

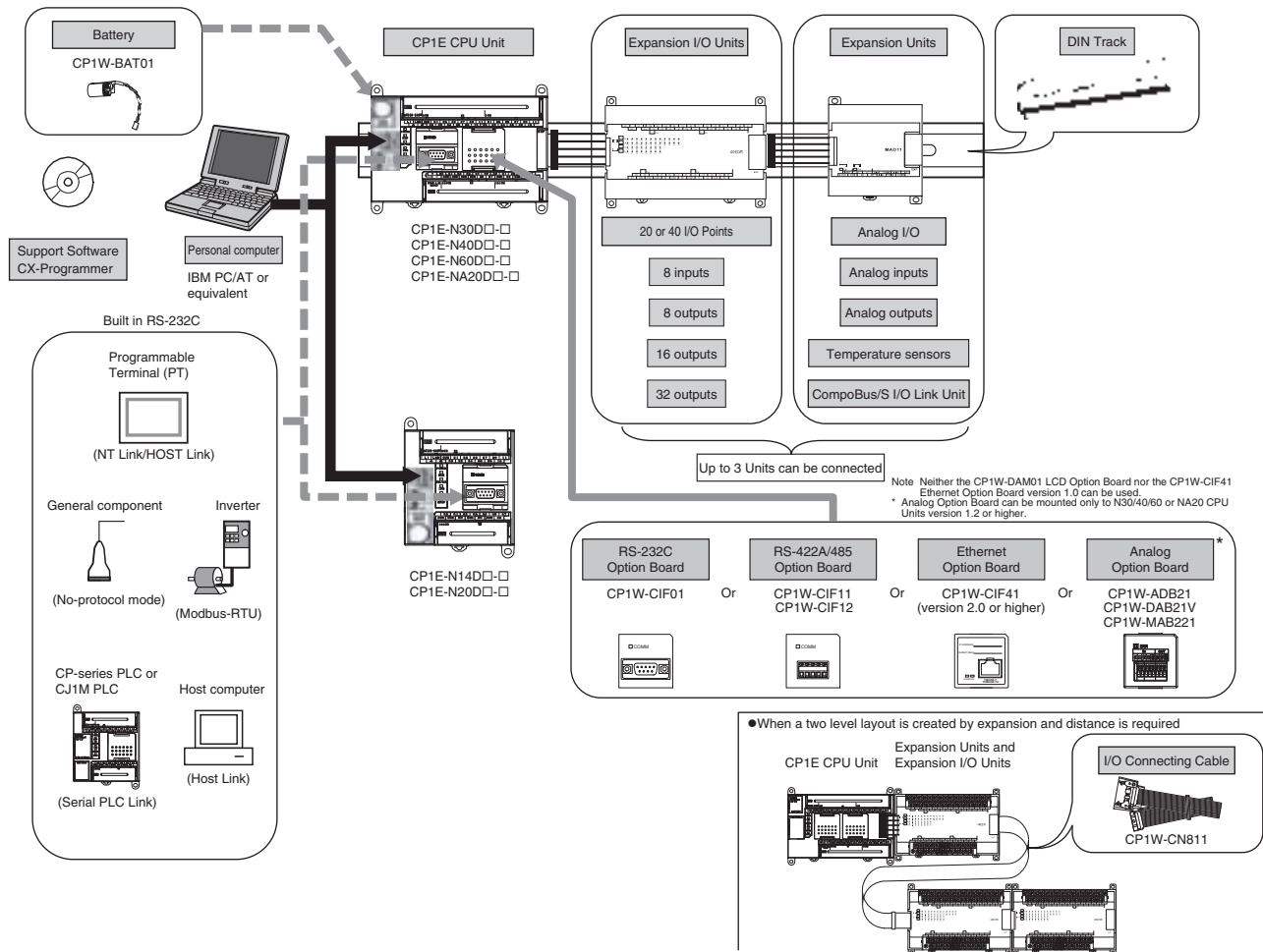

CP1E-E□□(S)D□-□ CP1E-N□□(S□)D□-□/NA20D□-□

Model Number Structure

■ Model Number Legend (Not all models that can be represented with the model number legend can necessarily be produced.)

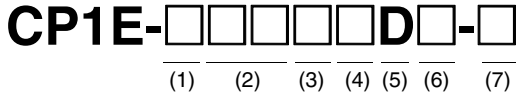

- | | | |
|---|--|---|
| <p>1. Class E : Basic model N : Application model NA : Application model with built-in analog</p> | <p>3. Unit type S : Renewal None : Normal</p> | <p>6. Output type R : Relays outputs T : Transistor outputs, sinking T1 : Transistor outputs, sourcing</p> |
| <p>2. I/O capacity 10 : 10 I/O points (6 inputs, 4 outputs) 14 : 14 I/O points (8 inputs, 6 outputs) 20 : 20 I/O points (12 inputs, 8 outputs) 30 : 30 I/O points (18 inputs, 12 outputs) 40 : 40 I/O points (24 inputs, 16 outputs) 60 : 60 I/O points (36 inputs, 24 outputs)</p> | <p>4. Built-in RS-485 port 1 : RS-485 None : -</p> | <p>7. Power supply A : AC power supply D : DC power supply</p> |
| | <p>5. Input type D : DC inputs</p> | |

Difference between E/N/NA□□-type and E/N□□S(1)-type

Basic Model

E□□(S)-type CPU Units

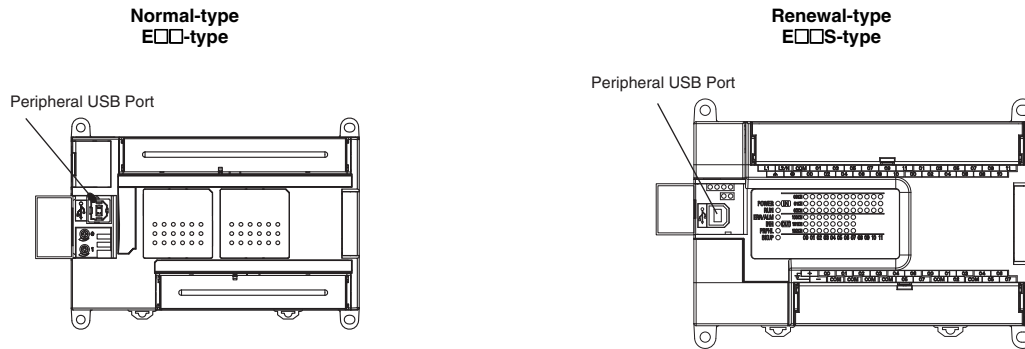

Difference in Characteristics and Functions

| Function | E□□-type (Normal) | E□□S-type (Renewal) |
|------------------|--|---|
| Analog adjusters | 2 adjusters (Setting range: 0 to 255) | None The analog adjuster PV in A642/A643 is fixed on 0000. |

Product Lineup

| | E□□ CPU Unit (Normal) | | | | E□□S CPU Unit (Renewal) | | | | |
|---------------|-----------------------|---------------|----|---------------------------------------|-------------------------|---------------|----|---------------------------------------|----|
| | Power supply | Relay outputs | | Transistor outputs (sinking/sourcing) | | Relay outputs | | Transistor outputs (sinking/sourcing) | |
| | | AC | DC | AC | DC | AC | DC | AC | DC |
| 10 I/O points | ○ | ○ | ○ | ○ | -- | -- | -- | -- | |
| 14 I/O points | ○ | -- | -- | -- | ○ | -- | -- | -- | |
| 20 I/O points | ○ | -- | -- | -- | ○ | -- | -- | -- | |
| 30 I/O points | ○ | -- | -- | -- | ○ | -- | -- | -- | |
| 40 I/O points | ○ | -- | -- | -- | ○ | -- | -- | -- | |
| 60 I/O points | -- | -- | -- | -- | ○ | -- | -- | -- | |

Application Model

N/NA□□(S)-type CPU Units

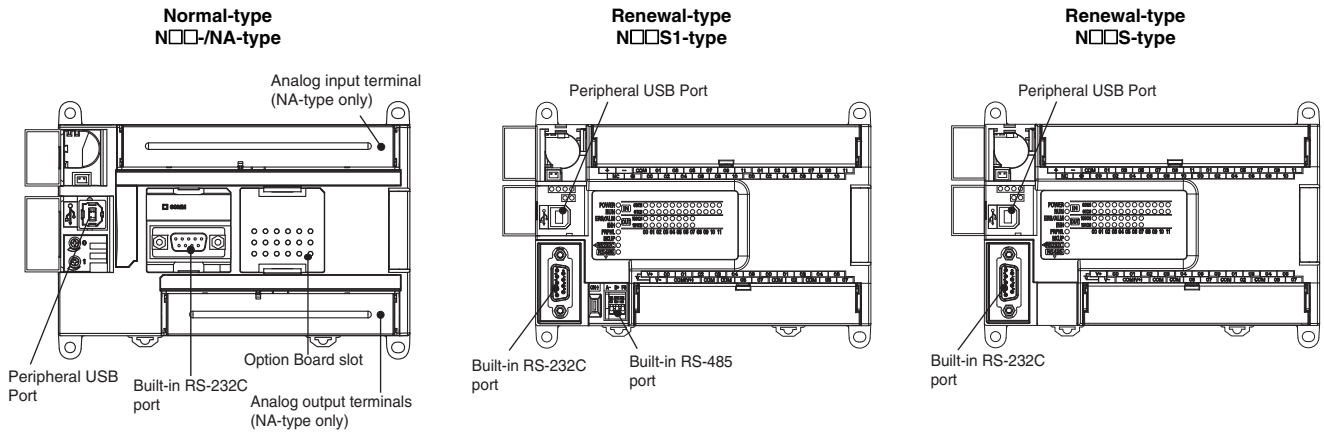

Difference in Characteristics and Functions

| Function | | N/NA□□-type (Normal) | N□□S(1)-type (Renewal) | | | | | | | | | | | | | | | | | | | | |
|---|----------------|--|--|----|----|----|----|-----|-----|-----|--|--|--|----|--|----|----|----|----|----|---------|-----|----|
| Analog adjusters | | 2 adjusters (Setting range: 0 to 255) | None The analog adjuster PV in A642/A643 is fixed on 0000. | | | | | | | | | | | | | | | | | | | | |
| Built-in RS-232C port | | 6 signals are supported: SD, RD, RS, CS, DR and ER. | 4 signals are supported: SD, RD, RS and CS. DR (pin 7) and ER (pin 8) are not supported. | | | | | | | | | | | | | | | | | | | | |
| Option board | | 1 port (N30/40/60, NA20 CPU Unit only) | Cannot be mounted There is no slot for an option board. | | | | | | | | | | | | | | | | | | | | |
| Built-in RS-485 port | | None | 1 port (N30/40/60S1 CPU Unit only) With 2-wire connections, it can only communicate in half duplex. Terminating resistance ON/OFF can be set by DIP switch. | | | | | | | | | | | | | | | | | | | | |
| Terminal Arrangements (Transistor outputs only) | COM allocation | <p>CIO 100.00 and CIO 100.01 correspond with different common terminals.</p> <table border="1" style="margin-left: auto; margin-right: auto;"> <tr><td>NC</td><td>00</td><td>01</td><td>02</td></tr> <tr><td>NC</td><td>COM</td><td>COM</td><td>COM</td></tr> <tr><td></td><td></td><td></td><td>03</td></tr> </table> <p>CIO 100.00 and CIO 100.01 are different COM.</p> | NC | 00 | 01 | 02 | NC | COM | COM | COM | | | | 03 | <p>CIO 100.00 and CIO 100.01 correspond with the same common terminal.</p> <table border="1" style="margin-left: auto; margin-right: auto;"> <tr><td>V+</td><td>00</td><td>01</td><td>02</td></tr> <tr><td>V-</td><td>COM(V-)</td><td>COM</td><td>03</td></tr> </table> <p>CIO 100.00 and CIO 100.01 are the same COM.</p> | V+ | 00 | 01 | 02 | V- | COM(V-) | COM | 03 |
| | NC | 00 | 01 | 02 | | | | | | | | | | | | | | | | | | | |
| NC | COM | COM | COM | | | | | | | | | | | | | | | | | | | | |
| | | | 03 | | | | | | | | | | | | | | | | | | | | |
| V+ | 00 | 01 | 02 | | | | | | | | | | | | | | | | | | | | |
| V- | COM(V-) | COM | 03 | | | | | | | | | | | | | | | | | | | | |
| Power supply for transistor outputs | | Not needed Do not connect an external power supply. | Needed It is necessary to connect a DC24V external power supply when using terminals 00 and 01 on terminal block CIO 100. Do not connect the external power supply to the terminals except 00 and 01 on terminal block CIO 100. | | | | | | | | | | | | | | | | | | | | |

Product Lineup

| | Normal-type | | | | | | Renewal-type | | | | | | | |
|------------------------------------|---|----|--|----|----|----|-----------------------------------|----|--|----|---|----|--|----|
| | N□□ CPU Unit RS-232C+1 option slot (*) | | | | | | N□□S CPU Unit Built-in RS-232C | | | | N□□S1 CPU Unit Built-in RS-232C+RS-485 | | | |
| | Relay outputs | | Transistor outputs (sinking/sourcing) | | | | Relay outputs | | Transistor outputs (sinking/sourcing) | | Relay outputs | | Transistor outputs (sinking/sourcing) | |
| Power supply | AC | DC | AC | DC | AC | DC | AC | DC | AC | DC | AC | DC | AC | DC |
| 10 I/O points | -- | -- | -- | -- | -- | -- | -- | -- | -- | -- | -- | -- | -- | -- |
| 14 I/O points | ○ | ○ | ○ | ○ | -- | -- | -- | -- | -- | -- | -- | -- | -- | -- |
| 20 I/O points | ○ | ○ | ○ | ○ | -- | -- | -- | -- | -- | -- | -- | -- | -- | -- |
| 30 I/O points | ○ | ○ | ○ | ○ | ○ | -- | -- | ○ | ○ | -- | -- | ○ | ○ | -- |
| 40 I/O points | ○ | ○ | ○ | ○ | ○ | -- | -- | ○ | ○ | ○ | -- | -- | ○ | ○ |
| 60 I/O points | ○ | ○ | ○ | ○ | ○ | -- | -- | ○ | ○ | ○ | -- | -- | ○ | ○ |
| 20 I/O points (Built-in analog) | ○ | -- | -- | ○ | -- | -- | -- | -- | -- | -- | -- | -- | -- | -- |

* 30, 40 and 60 I/O points only.

CP1E-E□□(S)D□-□ CP1E-N□□(S□)D□-□/NA20D□-□

Ordering Information





International Standards

- The standards are abbreviated as follows: U: UL, U1: UL (Class I Division 2 Products for Hazardous Locations), C: CSA, UC: cULus, UC1: cULus (Class I Division 2 Products for Hazardous Locations), CU: cUL, N: NK, L: Lloyd, and CE: EC Directives.
- Contact your OMRON representative for further details and applicable conditions for these standards.

Basic Model



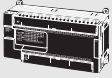

●Renewal-type

■E□□S-type CP1E CPU Units (Built-in USB port)

| Product name | Specifications | | | | | | External power supply (24 VDC) (A) | Current consumption (A) | | Model | Standards |
|---|----------------|--------|---------|-------------|------------------|----------------------|------------------------------------|-------------------------|------|---------------|-----------|
| | Power Supply | Inputs | Outputs | Output type | Program capacity | Data memory capacity | | 5 V | 24 V | | |
| E□□S-type CPU Units with 14 I/O Points  | 100 to 240 VAC | 8 | 6 | Relay | 2K steps | 2K words | -- | 0.16 | 0.07 | CP1E-E14SDR-A | CE |
| E□□S-type CPU Units with 20 I/O Points  | 100 to 240 VAC | 12 | 8 | Relay | 2K steps | 2K words | -- | 0.17 | 0.08 | CP1E-E20SDR-A | CE |
| E□□S-type CPU Units with 30 I/O Points  | 100 to 240 VAC | 18 | 12 | Relay | 2K steps | 2K words | 0.30 | 0.17 | 0.07 | CP1E-E30SDR-A | CE |
| E□□S-type CPU Units with 40 I/O Points  | 100 to 240 VAC | 24 | 16 | Relay | 2K steps | 2K words | 0.30 | 0.17 | 0.09 | CP1E-E40SDR-A | CE |
| E□□S-type CPU Units with 60 I/O Points  | 100 to 240 VAC | 36 | 24 | Relay | 2K steps | 2K words | 0.30 | 0.17 | 0.13 | CP1E-E60SDR-A | CE |

●Normal-type

■E□□-type CP1E CPU Units (Built-in USB port)



| Product name | Specifications | | | | | | External power supply (24 VDC) (A) | Current consumption (A) | | Model | Standards |
|---|----------------|--------|---------|-----------------------|------------------|----------------------|------------------------------------|-------------------------|------|----------------------|---------------|
| | Power Supply | Inputs | Outputs | Output type | Program capacity | Data memory capacity | | 5 V | 24 V | | |
| E□□-type CPU Units with 10 I/O Points  | 100 to 240 VAC | 6 | 4 | Relay | 2K steps | 2K words | -- | 0.08 | 0.04 | CP1E-E10DR-A | UC1, N, L, CE |
| | | | | Transistor (sinking) | | | -- | 0.11 | -- | CP1E-E10DT-A | |
| | | | | Transistor (sourcing) | | | -- | 0.11 | -- | CP1E-E10DT1-A | |
| | 24 VDC | | | Relay | | | -- | 0.08 | 0.04 | CP1E-E10DR-D | |
| | | | | Transistor (sinking) | | | -- | 0.11 | -- | CP1E-E10DT-D | |
| | | | | Transistor (sourcing) | | | -- | 0.11 | -- | CP1E-E10DT1-D | |
| E□□-type CPU Units with 14 I/O Points  | 100 to 240 VAC | 8 | 6 | Relay | 2K steps | 2K words | -- | 0.16 | 0.07 | CP1E-E14DR-A | UC1, N, L, CE |
| E□□-type CPU Units with 20 I/O Points  | 100 to 240 VAC | 12 | 8 | Relay | 2K steps | 2K words | -- | 0.17 | 0.08 | CP1E-E20DR-A | UC1, N, L, CE |
| E□□-type CPU Units with 30 I/O Points  | 100 to 240 VAC | 18 | 12 | Relay | 2K steps | 2K words | 0.30 | 0.17 | 0.07 | CP1E-E30DR-A | UC1, N, L, CE |
| E□□-type CPU Units with 40 I/O Points  | 100 to 240 VAC | 24 | 16 | Relay | 2K steps | 2K words | 0.30 | 0.17 | 0.09 | CP1E-E40DR-A | UC1, N, L, CE |

CP1E-E□□(S)D□-□ CP1E-N□□(S□)D□-□/NA20D□-□



Application Model

●Renewal-type

■N□□S1-type CP1E CPU Units (Built-in RS-232C, RS-485, USB ports)





| Product name | Specifications | | | | | | External power supply (24 VDC) (A) | Current consumption (A) | | Model | Standards |
|---|----------------|--------|---------|-----------------------|------------------|----------------------|------------------------------------|-------------------------|------|-----------------|-----------|
| | Power Supply | Inputs | Outputs | Output type | Program capacity | Data memory capacity | | 5 V | 24 V | | |
| N□□S1-type CPU Units with 30 I/O Points  | 100 to 240 VAC | 18 | 12 | Relay | 8K steps | 8K words | 0.30 | 0.21 | 0.07 | CP1E-N30S1DR-A | CE |
| | DC24V | | | Transistor (sinking) | | | -- | 0.27 | 0.02 | CP1E-N30S1DT-D | |
| | | | | Transistor (sourcing) | | | -- | 0.27 | 0.02 | CP1E-N30S1DT1-D | |
| N□□S1-type CPU Units with 40 I/O Points  | 100 to 240 VAC | 24 | 16 | Relay | 8K steps | 8K words | 0.30 | 0.21 | 0.09 | CP1E-N40S1DR-A | CE |
| | DC24V | | | Transistor (sinking) | | | -- | 0.31 | 0.02 | CP1E-N40S1DT-D | |
| | | | | Transistor (sourcing) | | | -- | 0.31 | 0.02 | CP1E-N40S1DT1-D | |
| N□□S1-type CPU Units with 60 I/O Points  | 100 to 240 VAC | 36 | 24 | Relay | 8K steps | 8K words | 0.30 | 0.21 | 0.13 | CP1E-N60S1DR-A | CE |
| | DC24V | | | Transistor (sinking) | | | -- | 0.31 | 0.02 | CP1E-N60S1DT-D | |
| | | | | Transistor (sourcing) | | | -- | 0.31 | 0.02 | CP1E-N60S1DT1-D | |

■N□□S-type CP1E CPU Units (Built-in RS-232C, USB ports)



| Product name | Specifications | | | | | | External power supply (24 VDC) (A) | Current consumption (A) | | Model | Standards |
|---|----------------|--------|---------|-----------------------|------------------|----------------------|------------------------------------|-------------------------|------|----------------|-----------|
| | Power Supply | Inputs | Outputs | Output type | Program capacity | Data memory capacity | | 5 V | 24 V | | |
| N□□S-type CPU Units with 30 I/O Points  | 100 to 240 VAC | 18 | 12 | Relay | 8K steps | 8K words | 0.30 | 0.21 | 0.07 | CP1E-N30SDR-A | CE |
| | DC24V | | | Transistor (sinking) | | | -- | 0.27 | 0.02 | CP1E-N30SDT-D | |
| | | | | Transistor (sourcing) | | | -- | 0.27 | 0.02 | CP1E-N30SDT1-D | |
| N□□S-type CPU Units with 40 I/O Points  | 100 to 240 VAC | 24 | 16 | Relay | 8K steps | 8K words | 0.30 | 0.21 | 0.09 | CP1E-N40SDR-A | CE |
| | DC24V | | | Transistor (sinking) | | | -- | 0.31 | 0.02 | CP1E-N40SDT-D | |
| | | | | Transistor (sourcing) | | | -- | 0.31 | 0.02 | CP1E-N40SDT1-D | |
| N□□S-type CPU Units with 60 I/O Points  | 100 to 240 VAC | 36 | 24 | Relay | 8K steps | 8K words | 0.30 | 0.21 | 0.13 | CP1E-N60SDR-A | CE |
| | DC24V | | | Transistor (sinking) | | | -- | 0.31 | 0.02 | CP1E-N60SDT-D | |
| | | | | Transistor (sourcing) | | | -- | 0.31 | 0.02 | CP1E-N60SDT1-D | |

●Normal-type

■N/NA□□-type CP1E CPU Units (Built-in RS-232C, USB ports)

| Product name | Specifications | | | | | | External power supply (24 VDC) (A) | Current consumption (A) | | Model | Standards |
|---|----------------|--------|---------|-----------------------|------------------|----------------------|------------------------------------|-------------------------|------|---------------|---------------|
| | Power Supply | Inputs | Outputs | Output type | Program capacity | Data memory capacity | | 5 V | 24 V | | |
| N□□-type CPU Units with 14 I/O Points  | 100 to 240 VAC | 8 | 6 | Relay | 8K steps | 8K words | -- | 0.17 | 0.07 | CP1E-N14DR-A | UC1, N, L, CE |
| | | | | Transistor (sinking) | | | -- | 0.22 | 0.02 | CP1E-N14DT-A | |
| | | | | Transistor (sourcing) | | | -- | 0.22 | 0.02 | CP1E-N14DT1-A | |
| | 24 VDC | | | Relay | | | -- | 0.17 | 0.07 | CP1E-N14DR-D | |
| | | | | Transistor (sinking) | | | -- | 0.22 | 0.02 | CP1E-N14DT-D | |
| | | | | Transistor (sourcing) | | | -- | 0.22 | 0.02 | CP1E-N14DT1-D | |
| N□□-type CPU Units with 20 I/O Points  | 100 to 240 VAC | 12 | 8 | Relay | 8K steps | 8K words | -- | 0.18 | 0.08 | CP1E-N20DR-A | UC1, N, L, CE |
| | | | | Transistor (sinking) | | | -- | 0.23 | 0.02 | CP1E-N20DT-A | |
| | | | | Transistor (sourcing) | | | -- | 0.23 | 0.02 | CP1E-N20DT1-A | |
| | 24 VDC | | | Relay | | | -- | 0.18 | 0.08 | CP1E-N20DR-D | |
| | | | | Transistor (sinking) | | | -- | 0.23 | 0.02 | CP1E-N20DT-D | |
| | | | | Transistor (sourcing) | | | -- | 0.23 | 0.02 | CP1E-N20DT1-D | |
| N□□-type CPU Units with 30 I/O Points  | 100 to 240 VAC | 18 | 12 | Relay | 8K steps | 8K words | 0.30 | 0.21 | 0.07 | CP1E-N30DR-A | UC1, N, L, CE |
| | | | | Transistor (sinking) | | | 0.30 | 0.27 | 0.02 | CP1E-N30DT-A | |
| | | | | Transistor (sourcing) | | | 0.30 | 0.27 | 0.02 | CP1E-N30DT1-A | |
| | 24 VDC | | | Relay | | | -- | 0.21 | 0.07 | CP1E-N30DR-D | |
| | | | | Transistor (sinking) | | | -- | 0.27 | 0.02 | CP1E-N30DT-D | |
| | | | | Transistor (sourcing) | | | -- | 0.27 | 0.02 | CP1E-N30DT1-D | |
| N□□-type CPU Units with 40 I/O Points  | 100 to 240 VAC | 24 | 16 | Relay | 8K steps | 8K words | 0.30 | 0.21 | 0.09 | CP1E-N40DR-A | UC1, N, L, CE |
| | | | | Transistor (sinking) | | | 0.30 | 0.31 | 0.02 | CP1E-N40DT-A | |
| | | | | Transistor (sourcing) | | | 0.30 | 0.31 | 0.02 | CP1E-N40DT1-A | |
| | 24 VDC | | | Relay | | | -- | 0.21 | 0.09 | CP1E-N40DR-D | |
| | | | | Transistor (sinking) | | | -- | 0.31 | 0.02 | CP1E-N40DT-D | |
| | | | | Transistor (sourcing) | | | -- | 0.31 | 0.02 | CP1E-N40DT1-D | |

CP1E-E□□(S)D□-□ CP1E-N□□(S□)D□-□/NA20D□-□

| Product name | Specifications | | | | | | External power supply (24 VDC) (A) | Current consumption (A) | | Model | Standards |
|---|----------------|-----------------------------------|-----------------------------------|-----------------------|------------------|----------------------|------------------------------------|-------------------------|------|----------------|---------------|
| | Power Supply | Inputs | Outputs | Output type | Program capacity | Data memory capacity | | 5 V | 24 V | | |
|  N□□-type CPU Units with 60 I/O Points | 100 to 240 VAC | 36 | 24 | Relay | 8K steps | 8K words | 0.30 | 0.21 | 0.13 | CP1E-N60DR-A | UC1, N, L, CE |
| | | | | Transistor (sinking) | | | 0.30 | 0.31 | 0.02 | CP1E-N60DT-A | |
| | | | | Transistor (sourcing) | | | 0.30 | 0.31 | 0.02 | CP1E-N60DT1-A | |
| | 24 VDC | | | Relay | | | -- | 0.21 | 0.13 | CP1E-N60DR-D | |
| | | | | Transistor (sinking) | | | -- | 0.31 | 0.02 | CP1E-N60DT-D | |
| | | | | Transistor (sourcing) | | | -- | 0.31 | 0.02 | CP1E-N60DT1-D | |
|  NA-type CPU Units with 20 I/O Points (Built-in analog) | 100 to 240 VAC | 12 (Built-in analog inputs: 2) | 8 (Built-in analog outputs: 1) | Relay | 8K steps | 8K words | 0.30 | 0.18 | 0.11 | CP1E-NA20DR-A | UC1, N, L, CE |
| | 24 VDC | | | Transistor (sinking) | | | -- | 0.23 | 0.09 | CP1E-NA20DT-D | |
| | | | | Transistor (sourcing) | | | -- | 0.23 | 0.09 | CP1E-NA20DT1-D | |







Optional Products

■ Battery Set

| Product name | Specifications | Model | Standards |
|---|--|------------|-----------|
|  Battery Set | For N/NA□□(S□)-type CP1E CPU Units Note: Mount a Battery to an N/NA□□(S□)-type CPU Unit if the data in the following areas must be backed up for power interruptions. • DM Area (D) (except backed up words in the DM Area), Holding Area (H), Counter Completion Flags (C), Counter Present Values (C), Auxiliary Area (A), and Clock Function (Use batteries within two years of manufacture.) | CP1W-BAT01 | -- |

■ Option Board (for CP1E N30/40/60 or NA20 CPU Units)











The Options cannot be used for CP1E N14/20, N30/40/60S(1), E10/14/20/30/40/60(S) CPU Units.

| Product name | Specifications | Model | Standards |
|---|---|-------------|---------------|
|  RS-232C Option Board | One RS-232C Option Board can be mounted to the Option Board slot. One RS-232C connector is included. | CP1W-CIF01 | UC1, N, L, CE |
|  RS-422A/485 Option Board | One RS-422A/485 Option Board can be mounted to the Option Board slot. | CP1W-CIF11 | |
|  RS-422A/485 Isolated-type Option Board | | CP1W-CIF12 | |
|  Ethernet Option Board | One Ethernet Option Board can be mounted to the Option Board slot. CP1E CPU Units are supported by CP1W-CIF41 version 2.0 or higher. When using CP1W-CIF41, CX-Programmer version 9.12 or higher is required. | CP1W-CIF41 | |
|  Analog Input Option Board | Can be mounted in CPU Unit Option Board slot. 2 analog inputs. 0-10V(Resolution:1/4000), 0-20mA (Resolution:1/2000). | CP1W-ADB21 | |
|  Analog Output Option Board | Can be mounted in CPU Unit Option Board slot. 2 analog outputs. 0-10V (Resolution:1/4000). | CP1W-DAB21V | |
|  Analog I/O Option Board | Can be mounted in CPU Unit Option Board slot. 2 analog inputs. 0-10V(Resolution:1/4000), 0-20mA(Resolution:1/2000). 2 analog outputs. 0-10V (Resolution:1/4000). | CP1W-MAB221 | |

Note: It is not possible to use a CP-series Ethernet Option Board version 1.0 (CP1W-CIF41), LCD Option Board (CP1W-DAM01), or Memory Card (CP1W-ME05M) with a CP1E CPU Unit.

■ Expansion I/O Units and Expansion Units (for CP1E E30/40/60(S), N30/40/60(S□), or NA20 CPU Units)

CP1E E10/14/20(S) or N14/20 CPU Units do not support Expansion I/O Units and Expansion Units.

| Unit type | Product name | Specifications | | | Current consumption (A) | | Model | Standards | | |
|---|--|----------------|---------|---|--|---------------------|-------------|----------------|---------------|---------------|
| | | Inputs | Outputs | Output type | 5 V | 24 V | | | | |
| CP1W Expansion I/O Units |  Input Unit | 8 | -- | 24 VDC Input | 0.018 | -- | CP1W-8ED | U, C, N, L, CE | | |
| |  Output Units | -- | 8 | Relay | 0.026 | 0.044 | CP1W-8ER | | | |
| | | | | Transistor (sinking) | 0.075 | -- | CP1W-8ET | | | |
| | | | | Transistor (sourcing) | 0.075 | -- | CP1W-8ET1 | | | |
| |  Output Units | -- | 16 | Relay | 0.042 | 0.090 | CP1W-16ER | N, L, CE | | |
| | | | | Transistor (sinking) | 0.076 | -- | CP1W-16ET | | | |
| | | | | Transistor (sourcing) | 0.076 | -- | CP1W-16ET1 | | | |
| |  Output Units | -- | 32 | Relay | 0.049 | 0.131 | CP1W-32ER | N, L, CE | | |
| | | | | Transistor (sinking) | 0.113 | -- | CP1W-32ET | | | |
| | | | | Transistor (sourcing) | 0.113 | -- | CP1W-32ET1 | | | |
| |  I/O Units | 12 | 8 | Relay | 0.103 | 0.044 | CP1W-20EDR1 | U, C, N, L, CE | | |
| | | | | Transistor (sinking) | 0.130 | -- | CP1W-20EDT | | | |
| | | | | Transistor (sourcing) | 0.130 | -- | CP1W-20EDT1 | | | |
| | | 24 | 16 | Relay | 0.080 | 0.090 | CP1W-40EDR | N, L, CE | | |
| Transistor (sinking) | | | | 0.160 | -- | CP1W-40EDT | | | | |
| Transistor (sourcing) | | | | 0.160 | -- | CP1W-40EDT1 | | | | |
| CP1W Expansion Units |  Analog Input Unit | 4CH | -- | Input range: 0 to 5 V, 1 to 5 V, 0 to 10 V, ±10 V, 0 to 20 mA, or 4 to 20 mA. | Resolution: 1/6000 | 0.100 | 0.090 | CP1W-AD041 | UC1, N, L, CE | |
| | | | | | Resolution: 1/12000 | 0.100 | 0.050 | CP1W-AD042 | UC1, CE | |
| |  Analog Output Unit | -- | 2CH | 4CH | Output range: 1 to 5 V, 0 to 10 V, ±10 V, 0 to 20 mA, or 4 to 20 mA. | Resolution: 1/6000 | 0.040 | 0.095 | CP1W-DA021 | UC1, N, L, CE |
| | | | | | | Resolution: 1/6000 | 0.080 | 0.124 | CP1W-DA041 | |
| | | | | | | Resolution: 1/12000 | 0.070 | 0.160 | CP1W-DA042 | |
| |  Analog I/O Unit | 4CH | 4CH | 2CH | Input range: 0 to 5 V, 1 to 5 V, 0 to 10 V, ±10 V, 0 to 20 mA, or 4 to 20 mA. Output range: 1 to 5 V, 0 to 10 V, ±10 V, 0 to 20 mA, or 4 to 20 mA. | Resolution: 1/12000 | 0.120 | 0.170 | CP1W-MAD44 | CE |
| | | | | | | Resolution: 1/12000 | 0.120 | 0.120 | CP1W-MAD42 | UC1, CE |
| | | | | | | Resolution: 1/6000 | 0.083 | 0.110 | CP1W-MAD11 | UC1, N, L, CE |
| |  Temperature Sensor Unit | 2CH | -- | -- | Sensor type: Thermocouple (J or K) | 0.040 | 0.059 | CP1W-TS001 | UC1, N, L, CE | |
| | | | | | | 0.040 | 0.059 | CP1W-TS002 | | |
| | | 2CH | -- | -- | Sensor type: Platinum resistance thermometer (Pt100 or JPt100) | 0.054 | 0.073 | CP1W-TS101 | | |
| | | | | | | 0.054 | 0.073 | CP1W-TS102 | | |
| | | 4CH | -- | -- | Sensor type: Thermocouple (J or K) 2channels can be used as analog input. Input range: 1 to 5 V, 0 to 10 V, 4-20 mA | Resolution: 1/12000 | 0.070 | 0.030 | | CP1W-TS003 |
| | | | | | | 0.080 | 0.050 | CP1W-TS004 | | |
|  CompoBus/S I/O Link Unit | 8 | 8 | -- | CompoBus/S slave | 0.029 | -- | CP1W-SRT21 | UC1, N, L, CE | | |

■ I/O Connecting Cable

| Product name | Specifications | Model | Standards |
|----------------------|--|------------|---------------|
| I/O Connecting Cable | 80 cm (for CP1W Expansion I/O Units and Expansion Units) Only one I/O Connecting Cable can be used in each PLC. | CP1W-CN811 | UC1, N, L, CE |

Note: An I/O Connecting Cable (approx. 6 cm) for horizontal connection is provided with CP1W Expansion I/O Units and Expansion Units.

■DIN Track Accessories

| Name | Specifications | Model | Standards |
|-----------|---|-----------|-----------|
| DIN Track | Length: 0.5 m; Height: 7.3 mm | PFP-50N | --- |
| | Length: 1 m; Height: 7.3 mm | PFP-100N | |
| | Length: 1 m; Height: 16 mm | PFP-100N2 | |
| End Plate | A stopper to secure the Units on the DIN Track. | PFP-M | |

Programming Devices

■ Software

| Product name | Specifications | Required Programming Device *1 | | Model | Standards |
|---|---|--------------------------------|-------|-----------------------|-----------|
| | | Number of licenses | Media | | |
| FA Integrated Tool Package CX-One Lite Ver.4.□ | CX-One Lite is a subset of the complete CX-One package that provides only the Support Software required for micro PLC applications. CX-One Lite runs on the following OS. OS: Windows XP (Service Pack 3 or higher, 32-bit version) / Windows Vista (32-bit/64-bit version) / Windows 7 (32-bit/64-bit version) / Windows 8 (32-bit/64-bit version) / Windows 8.1 (32-bit/64-bit version) CX-One Lite Ver. 4.□ includes Micro PLC Edition CX-Programmer Ver.9.□. | 1 license | CD | CXONE-LT01C-V4 | -- |
| FA Integrated Tool Package CX-One Package Ver. 4.□ | CX-One is a comprehensive software package that integrates Support Software for OMRON PLCs and components. CX-One runs on the following OS. OS: Windows XP (Service Pack 3 or higher, 32-bit version) / Windows Vista (32-bit/64-bit version) / Windows 7 (32-bit/64-bit version) / Windows 8 (32-bit/64-bit version) / Windows 8.1 (32-bit/64-bit version) CX-One Ver. 4.□ includes CX-Programmer Ver. 9.□. | 1 license *1 | DVD*2 | CXONE-AL01D-V4 | -- |

Note: 1. The E20/30/40(S), N20/N30/N40(S) CPU Units are supported by CX-Programmer version 8.2 or higher. The E10, E14, N14, N60, and NA20 CPU Units are supported by CX-Programmer version 9.03 or higher. When Micro PLC Edition CX-Programmer is used, you need version 9.03 or higher.
The E60S CPU Units are supported by CX-Programmer version 9.42 or higher. When Micro PLC Edition CX-Programmer is used, you need version 9.42 or higher.

2. The CX-One and CX-One Lite cannot be simultaneously installed on the same computer.

* 1 Multi licenses are available for the CX-One (3, 10, 30 or 50 licenses).

* 2 The CX-One is also available on CD (CXONE-AL□□C-V4).

The following tables lists the Support Software that can be installed from CX-One

| Support Software in CX-One | | CX-One Lite Ver.4.□ | CX-One Ver.4.□ | Support Software in CX-One | | CX-One Lite Ver.4.□ | CX-One Ver.4.□ |
|---------------------------------|---------|---------------------|----------------|-------------------------------|---------|---------------------|----------------|
| Micro PLC Edition CX-Programmer | Ver.9.□ | Yes | No | CX-Drive | Ver.1.□ | Yes | Yes |
| CX-Programmer | Ver.9.□ | No | Yes | CX-Process Tool | Ver.5.□ | No | Yes |
| CX-Integrator | Ver.2.□ | Yes | Yes | Faceplate Auto-Builder for NS | Ver.3.□ | No | Yes |
| Switch Box Utility | Ver.1.□ | Yes | Yes | CX-Designer | Ver.3.□ | Yes | Yes |
| CX-Protocol | Ver.1.□ | No | Yes | NV-Designer | Ver.1.□ | Yes | Yes |
| CX-Simulator | Ver.1.□ | Yes | Yes | CX-Thermo | Ver.4.□ | Yes | Yes |
| CX-Position | Ver.2.□ | No | Yes | CX-ConfiguratorFDT | Ver.1.□ | Yes | Yes |
| CX-Motion-NCF | Ver.1.□ | No | Yes | CX-FLnet | Ver.1.□ | No | Yes |
| CX-Motion-MCH | Ver.2.□ | No | Yes | Network Configurator | Ver.3.□ | Yes | Yes |
| CX-Motion | Ver.2.□ | No | Yes | CX-Server | Ver.4.□ | Yes | Yes |

Note: For details, refer to the CX-One Catalog (Cat. No. R134).

Unit Versions

| Units | Model numbers | Unit version |
|----------------|--|------------------|
| CP1E CPU Units | CP1E-E□□SDR-A CP1E-N□□S□D□-□ CP1E-E□□D□-□ CP1E-N□□D□-□ CP1E-NA□□D□-□ | Unit version 1.□ |

Unit Versions and Programming Devices

The following tables show the relationship between unit versions and CX-Programmer versions.

| CPU Unit | Functions | Required Programming Device *1 | | | | | | |
|--|----------------------------|--------------------------------|--------------------|--------------------|---------------------------------|--------------------|--------------------|------------------------|
| | | CX-Programmer | | | Micro PLC Edition CX-Programmer | | | CX-Programmer for CP1E |
| | | Ver.8.2 or higher | Ver.9.03 or higher | Ver.9.42 or higher | Ver.8.2 or higher | Ver.9.03 or higher | Ver.9.42 or higher | Ver.1.0 |
| CP1E-E20/30/40(S)D□-A CP1E-N20/30/40(S□)D□-□ | Unit version 1.□ functions | Yes *3 | Yes *2 | Yes *2 | Yes *3 | Yes *2 | Yes *2 | Yes *2 |
| CP1E-E10D□-□ CP1E-□14(S)D□-□ CP1E-N60(S□)D□-□ CP1E-NA20D□-□ | Unit version 1.□ functions | No | Yes *2 | Yes *2 | No | Yes *2 | Yes *2 | No |
| CP1E-E60SDR-A | Unit version 1.□ functions | No | No | Yes *2 | No | No | Yes *2 | No |

Note: 1. To update the CX-Programmer, the CX-One version 3/version 4 auto-update must be installed.

2. Use the CX-Programmer version 9.12 or higher, when the CP1W-CIF41 is applied.

* 1 A Programming Console cannot be used.

* 2 Supports Smart Input function.

* 3 Does not support Smart Input function.

CP1E-E□□(S)D□-□ CP1E-N□□(S□)D□-□/NA20D□-□

General Specifications

| Type | AC power supply models | | DC power supply models |
|---------------------------|--|---|---|
| Model | CP1E-□□□S□D□-A CP1E-□□□D□-A | | CP1E-□□□S□D□-D CP1E-□□□D□-D |
| Enclosure | Mounted in a panel | | |
| Dimensions (H × D × W) | E/N/NA□□-type CPU Unit with 10 I/O points (CP1E-E10D□-□): 90mm *1 × 85mm *2 × 66 mm CPU Unit with 14 or 20 I/O points (CP1E-□14D□-□/□20D□-□): 90mm *1 × 85mm *2 × 86 mm CPU Unit with 30 I/O points (CP1E-□30D□-□): 90mm *1 × 85mm *2 × 130 mm CPU Unit with 40 I/O points (CP1E-□40D□-□): 90mm *1 × 85mm *2 × 150 mm CPU Unit with 60 I/O points (CP1E-N60D□-□): 90mm *1 × 85mm *2 × 195 mm CPU Unit with 20 I/O points and built-in analog (CP1E-NA20D□-□): 90mm *1 × 85mm *2 × 130 mm E/N/□□S(1)-type CPU Unit with 14 or 20 I/O points (CP1E-□14SD□-□/□20SD□-□): 90mm *1 × 79mm *2 × 86 mm CPU Unit with 30 I/O points (CP1E-□30S(1)D□-□): 90mm *1 × 79mm *2 × 130 mm CPU Unit with 40 I/O points (CP1E-□40S(1)D□-□): 90mm *1 × 79mm *2 × 150 mm CPU Unit with 60 I/O points (CP1E-□60S(1)D□-□): 90mm *1 × 79mm *2 × 195 mm | | |
| Weight | CPU Unit with 10 I/O points (CP1E-E10D□-□): 300g max. CPU Unit with 14 I/O points (CP1E-□14(S)D□-□): 360g max. CPU Unit with 20 I/O points (CP1E-□20(S)D□-□): 370g max. CPU Unit with 30 I/O points (CP1E-□30(S□)D□-□): 600g max. CPU Unit with 40 I/O points (CP1E-□40(S□)D□-□): 660g max. CPU Unit with 60 I/O points (CP1E-□60(S□)D□-□): 850g max. CPU Unit with 20 I/O points and built-in analog (CP1E-NA20D□-□): 680g max. | | |
| Electrical specifications | Supply voltage | 100 to 240 VAC 50/60 Hz | 24 VDC |
| | Operating voltage range | 85 to 264 VAC | 20.4 to 26.4 VDC |
| | Power consumption | 15 VA/100 VAC max. 25 VA/240 VAC max. (CP1E-E10D□-A/□14(S)D□-A/□20(S)D□-A) | 9 W max. (CP1E-E10D□-D) 13 W max. (CP1E-N14D□-D/N20D□-D) |
| | | 50 VA/100 VAC max. 70 VA/240 VAC max. (CP1E-NA20D□-A/□30(S□)D□-A/□40(S□)D□-A/ N60(S□)D□-A) | 20 W max. (CP1E-NA20D□-D/N30(S□)D□-D/N40(S□)D□-D/ N60(S□)D□-D) *4 |
| | Inrush current | 120 VAC, 20 A for 8 ms max. for cold start at room temperature 240 VAC, 40 A for 8 ms max. for cold start at room temperature | 24 VDC, 30 A for 20 ms max. for cold start at room temperature |
| | External power supply *3 | Not provided. (CP1E-E10D□-A/□14(S)D□-A/□20(S)D□-A) 24 VDC, 300 mA (CP1E-NA20D□-A/□30D□-A/□40D□-A/□60D□-A/ □30SDR-A/□40SDR-A/□60SDR-A) | Not provided |
| | Insulation resistance | 20 MΩ min. (at 500 VDC) between the external AC terminals and GR terminals | Except between DC primary current and DC secondary current |
| | Dielectric strength | 2,300 VAC 50/60Hz for 1 min between AC external and GR terminals Leakage current: 5 mA max. | Except between DC primary current and DC secondary current |
| Power OFF detection time | 10 ms min. | 2 ms min. | |
| Application environment | Ambient operating temperature | 0 to 55 °C | |
| | Ambient humidity | 10% to 90% | |
| | Atmosphere | No corrosive gas. | |
| | Ambient storage temperature | -20 to 75 °C (excluding battery) | |
| | Altitude | 2,000 m max. | |
| | Pollution degree | 2 or less: Conforms to JIS B3502 and IEC 61131-2. | |
| | Noise resistance | 2 kV on power supply line (Conforms to IEC61000-4-4.) | |
| | Overvoltage category | Category II: Conforms to JIS B3502 and IEC 61131-2. | |
| | EMC Immunity Level | Zone B | |
| | Vibration resistance | Conforms to JIS 60068-2-6. 5 to 8.4 Hz with 3.5-mm amplitude, 8.4 to 150 Hz Acceleration of 9.8 m/s ² for 100 min in X, Y, and Z directions (10 sweeps of 10 min each = 100 min total) | |
| Shock resistance | Conforms to JIS 60068-2-27. 147 m/s ² , 3 times in X, Y, and Z directions | | |
| Terminal block | Fixed (not removable) | | |
| Terminal screw size | M3 | | |
| Applicable standards | Conforms to EC Directive | | |
| Grounding method | Ground to 100 Ω or less. | | |

* 1 Total of 110 mm with mounting brackets.

* 2 Excluding cables.

* 3 Use the external power supply to power input devices. Do not use it to drive output devices.

* 4 This is the rated value for the maximum system configuration. Use the following formula to calculate power consumption for CPU Units with DC power.
 Formula: DC power consumption = (5V current consumption × 5 V/70% (internal power efficiency) + 24V current consumption) × 1.1 (current fluctuation factor)

The above calculation results show that a DC power supply with a greater capacity is required.

Performance Specifications

| Item | | CP1E-E□□SD□-□ CP1E-□□D□-□ | CP1E-N□□S□D□-□ CP1E-N□□D□-□ CP1E-NA□□D□-□ | |
|--|--|--|--|--|
| Program capacity | | 2 K steps (8 Kbytes) including the symbol table, comments, and program indices of the CX-Programmer | 8 K steps (32 Kbytes) including the symbol table, comments, and program indices of the CX-Programmer | |
| Control method | | Stored program method | | |
| I/O control method | | Cyclic scan with immediate refreshing | | |
| Program language | | Ladder diagram | | |
| Instructions | | Approximately 200 | | |
| Processing speed | Overhead processing time | 0.4 ms | | |
| | Instruction execution times | Basic instructions (LD): 1.19 μs min. Special instructions (MOV): 7.9 μs min. | | |
| Number of CP1W-series Expansion Units connected | | CP1E-E10D□-□/□14(S)D□-□/□20(S)D□-□: None CP1E-□30(S□)D□-□/□40(S□)D□-□/□60(S□)D□-□/NA20(S□)D□-□: 3 units | | |
| Maximum number of I/O points | | CP1E-E10D□-□ : 10 CP1E-□14(S)D□-□: 14 CP1E-□20(S)D□-□: 20 CP1E-□30(S□)D□-□: 150 (30 built in, 40 × 3 expansion) CP1E-□40(S□)D□-□: 160 (40 built in, 40 × 3 expansion) CP1E-□60(S□)D□-□: 180 (60 built in, 40 × 3 expansion) CP1E-NA20D□-□: 140 (20 built in, 40 × 3 expansion) | | |
| Built-in I/O | | CP1E-E10D□-□ : 10 (6 inputs, 4 outputs) CP1E-□14(S)D□-□: 14 (8 inputs, 6 outputs) CP1E-□20(S)D□-□: 20 (12 inputs, 8 outputs) CP1E-□30(S□)D□-□: 30 (18 inputs, 12 outputs) CP1E-□40(S□)D□-□: 40 (24 inputs, 16 outputs) CP1E-□60(S□)D□-□: 60 (36 inputs, 24 outputs) CP1E-NA20D□-□: 20 (12 inputs, 8 outputs) | | |
| Built-in input functions | High-speed counters | High-speed counter mode/maximum frequency | Incremental Pulse Inputs 10 kHz: 6 counters 5 counters (only for 10 I/O points) Up/Down Inputs 10 kHz: 2 counters Pulse + Direction Inputs 10 kHz: 2 counters Differential Phase Inputs (4x) 5 kHz: 2 counters | Incremental Pulse Inputs 100 kHz: 2 counters, 10 kHz: 4 counters Up/Down Inputs 100 kHz: 1 counters, 10 kHz: 1 counters Pulse + Direction Inputs 100 kHz: 2 counters Differential Phase Inputs (4x) 50 kHz: 1 counter, 5 kHz: 1 counter |
| | | Counting mode | Linear mode Ring mode | |
| | | Count value | 32 bits | |
| | | Counter reset modes | Phase Z and software reset (excluding increment pulse input) Software reset | |
| | Control method | Target Matching Range Comparison | | |
| | Input interrupts | 6 inputs (4 inputs only for 10 I/O points) Interrupt input pulse width: 50 μs min. | | |
| | Quick-response Inputs | 6 inputs (4 inputs only for 10 I/O points) Input pulse width: 50 μs min. | | |
| Normal input | Input constants | Delays can be set in the PLC Setup (0 to 32 ms, default: 8 ms). Set values: 0, 1, 2, 4, 8, 16, or 32 ms | | |
| Built-in output functions | Pulse outputs (Models with transistor outputs only) | Pulse output method and output frequency | | Pulse + Direction Mode 1 Hz to 100 kHz: 2 outputs |
| | | Output mode | | Continuous mode (for speed control) Independent mode (for position control) |
| | | Number of output pulses | | Relative coordinates: 0000 0000 to 7FFF FFFF hex (0 to 2147483647) Absolute coordinates: 8000 0000 to 7FFF FFFF hex (-2147483647 to 2147483647) |
| | | Acceleration/deceleration curves | | Trapezoidal acceleration and deceleration (Cannot perform S-curve acceleration and deceleration.) |
| | | Changing SVs during instruction execution | | Only target position can be changed. |
| | | Origin searches | | Included |
| | Pulse outputs (Models with transistor outputs only) | Frequency | | 2.0 to 6,553.5 Hz (in increments of 0.1 Hz) with 1 output or 2 Hz to 32,000 Hz (in increments of 1 Hz) with 1 output |
| | Duty factor | PWM output function not included | 0.0% to 100.0% (in increments of 0.1%) Accuracy: +1%/-0% at 2 Hz to 10,000 Hz and +5%/-0% at 10,000 Hz to 32,000 kHz | |
| | Output mode | | Continuous Mode | |
| Built-in analog | Analog input | Analog function not included | | |
| | Analog output | Setting range: 0 to 6,000 (2 channels only for NA-type) Setting range: 0 to 6,000 (1 channels only for NA-type) | | |
| Analog adjusters | | E/N/NA□□-type: 2 adjusters (Setting range: 0 to 255) E/N□□S(1)-type: None | | |

CP1E-E□□(S)D□-□ CP1E-N□□(S□)D□-□/NA20D□-□

| Item | | CP1E-E□□SD□-□ CP1E-E□□D□-□ | CP1E-N□□S□D□-□ CP1E-N□□D□-□ CP1E-NA□□D□-□ | |
|-------------------------------------|--|--|--|---|
| Communications | B-type Peripheral USB Port | Conforming to USB 2.0 B type connector | | |
| | | Transmission distance | 5 m max. | |
| | Built-in RS-232C port | No built-in RS-232C port | Interface: Conforms to EIA RS-232C. | |
| | | | Communications method | Half duplex |
| | | | synchronization | Start-stop |
| | | | Baud rate | 1.2, 2.4, 4.8, 9.6, 19.2, 38.4, 57.6, or 115.2 kbps |
| | | | Transmission distance | 15 m max. |
| | | Supported protocol | <ul style="list-style-type: none"> • Host Link • 1:N NT Link • No-protocol mode • Serial PLC Links (master, slave) • Modbus-RTU Easy Master | |
| | Built-in RS-485 port | No built-in RS-485 port | N30/40/60S1-type only Interface: Conforms to EIA RS-485. 2-wire sensors No isolation | |
| | | | Communications method | Half duplex |
| | synchronization | | Start-stop | |
| | Baud rate | | 1.2, 2.4, 4.8, 9.6, 19.2, 38.4, 57.6, or 115.2 kbps | |
| | Transmission distance | | 50 m max. | |
| | Supported protocol | <ul style="list-style-type: none"> • Host Link • 1:N NT Link • No-protocol mode • Serial PLC Links (master, slave) • Modbus-RTU Easy Master | | |
| Serial Option port | Option Board cannot be mounted. | N30/40/60 and NA20-type only 1 port | | |
| | | Mountable Option Boards | <ul style="list-style-type: none"> • One RS-232C port: CP1W-CIF01 • One RS-422A/485 port (not isolated): CP1W-CIF11 • One RS-422A/485 port (isolated): CP1W-CIF12 • One Ethernet port: CP1W-CIF41 | |
| | | Communications method | Depends on Option Board. | |
| | | synchronization | Depends on Option Board. | |
| | | Baud rate | 1.2, 2.4, 4.8, 9.6, 19.2, 38.4, 57.6, or 115.2 kbps | |
| | Compatible protocols | <ul style="list-style-type: none"> • Host Link • 1:N NT Link • No-protocol mode • Serial PLC Links (master, slave) • Modbus-RTU Easy Master | | |
| Number of tasks | | 17 <ul style="list-style-type: none"> • One cyclic execution task • One scheduled interrupt task (always interrupt task 1) • Six input interrupt tasks (interrupt tasks 2 to 7) • Sixteen high-speed counter interrupt tasks (interrupt tasks 1 to 16) | | |
| Maximum subroutine number | | 128 | | |
| Maximum jump number | | 128 | | |
| Scheduled interrupt tasks | | 1 interrupt task | | |
| Clock | | Clock function not included. The time of error occurrence displays 01-01-01 01:01:01 Sunday | Included. Accuracy (monthly deviation): -4.5 min to -0.5 min at ambient temperature of 55°C, -2.0 min to +2.0 min at ambient temperature of 25°C, -2.5 min to +1.5 min at ambient temperature of 0°C | |
| Memory backup | Built-in EEPROM | Ladder programs and parameters are automatically saved to built-in EEPROM A section of the Data Memory Area can be saved to the built-in EEPROM. | | |
| | Battery backup With CP1W-BAT01 Battery (Sold separately) | Battery cannot be mounted. | CP1W-BAT01 can be used. Maximum battery service life: 5 years Backup Time Guaranteed value (ambient temperature: 55°C): 13,000 hours (approx. 1.5 years) Effective value (ambient temperature: 25°C): 43,000 hours (approx. 5 years) | |
| CIO Area | Input Bits | 1,600 bits (100 words): CIO 0.00 to CIO 99.15 (CIO 00 to CIO 99) | | |
| | Output Bits | 1,600 bits (100 words): CIO 100.00 to CIO 199.15 (CIO 100 to CIO 199) | | |
| | Serial PLC Link Words | 1,440 bits (90 words): CIO 200.00 to CIO 289.15 (words CIO 200 to CIO 289) | | |
| Work Area (W) | | 1,600 bits (100 words): W0.00 to W99.15 (W0 to W99) | | |
| Holding Area (H) | | 800 bits (50 words): H0.00 to H49.15 (H0 to H49) Bits in this area maintain their ON/OFF status when operating mode is changed. | | |
| Auxiliary Area (A) | | Read-only: 7,168 bits (448 words) A0 to A447 Read/write: 4,896 bits (306 words) in words A448 to A753 | | |
| Temporary Relay Area (TR) (TR Area) | | 16 bits: TR0 to TR15 | | |
| Timer Area (T) | | 256 timer numbers (T0 to T255 (separate from counters)) | | |
| Counter Area (C) | | 256 counter numbers (C0 to C255 (separate from timers)) | | |

CP1E-E□□(S)D□-□ CP1E-N□□(S□)D□-□/NA20D□-□

| Item | CP1E-E□□SD□-□ CP1E-E□□D□-□ | CP1E-N□□S□D□-□ CP1E-N□□D□-□ CP1E-NA□□D□-□ |
|-----------------------------|---|--|
| Data Memory Area (D) | 2 Kwords: D0 to D2047 Of these, 1,500 words can be saved to the backup memory (built-in EEPROM) using settings in the Auxiliary Area. | 8 Kwords: D0 to D8191 Of these, 7,000 words can be saved to the backup memory (built-in EEP-ROM) using settings in the Auxiliary Area |
| Operating modes | PROGRAM mode: Program execution is stopped. Preparations can be executed prior to program execution in this mode. MONITOR mode: Programs are executed. Some operations, such as online editing, and changes to present values in I/O memory, are enabled in this mode. RUN mode: Programs are executed. This is the normal operating mode. | |

Internal Memory in the CPU Units

CPU Unit Memory Backup Structure

The internal memory in the CPU Unit consists of built-in RAM and built-in EEPROM. The built-in RAM is used as execution memory and the built-in EEPROM is used as backup memory.

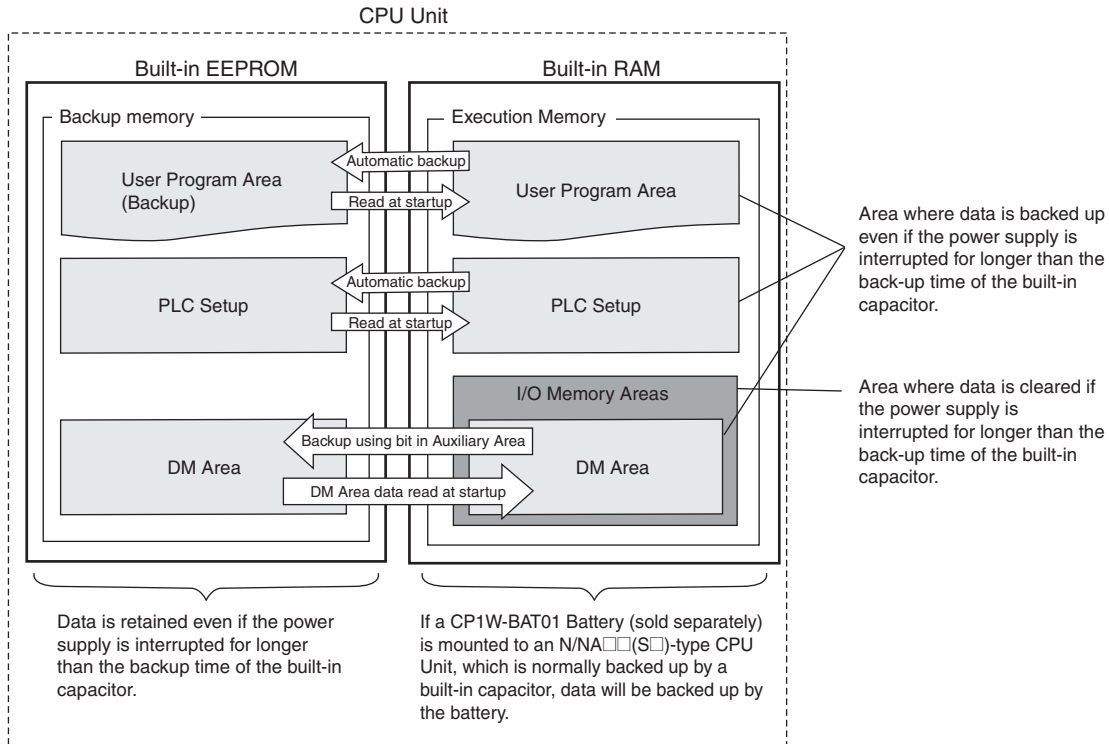

●Precautions for Correct Use

Create a system and write the ladder programs so that problems will not occur in the system if the data in these area may be unstable.

- Data in areas such as the DM area (D), Holding Area (H), the Counter Present Values (C) and the status of Counter Completion Flags (C), which is retained by the battery, may be unstable when the power supply is turned off (Except for the DM area that are retained by the built-in EEPROM using the Auxilliary Area bit.)
- The error log, and clock data (N/NA□□(S□)-type CPU Unit only) in the Auxiliary Area will become unstable. Other words and bits in the Auxiliary Area will be cleared to their default values.

The built-in capacitor's backup time varies with the ambient temperature as shown in the following graph.

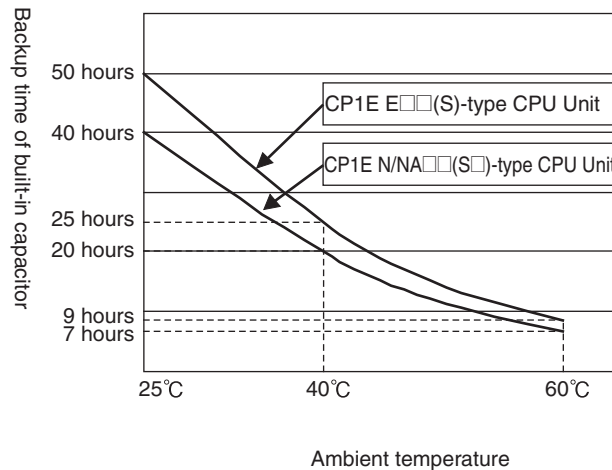

I/O Memory Areas

Data can be read and written to I/O memory from the ladder programs. I/O memory consists of an area for I/O with external devices, user areas, and system areas.

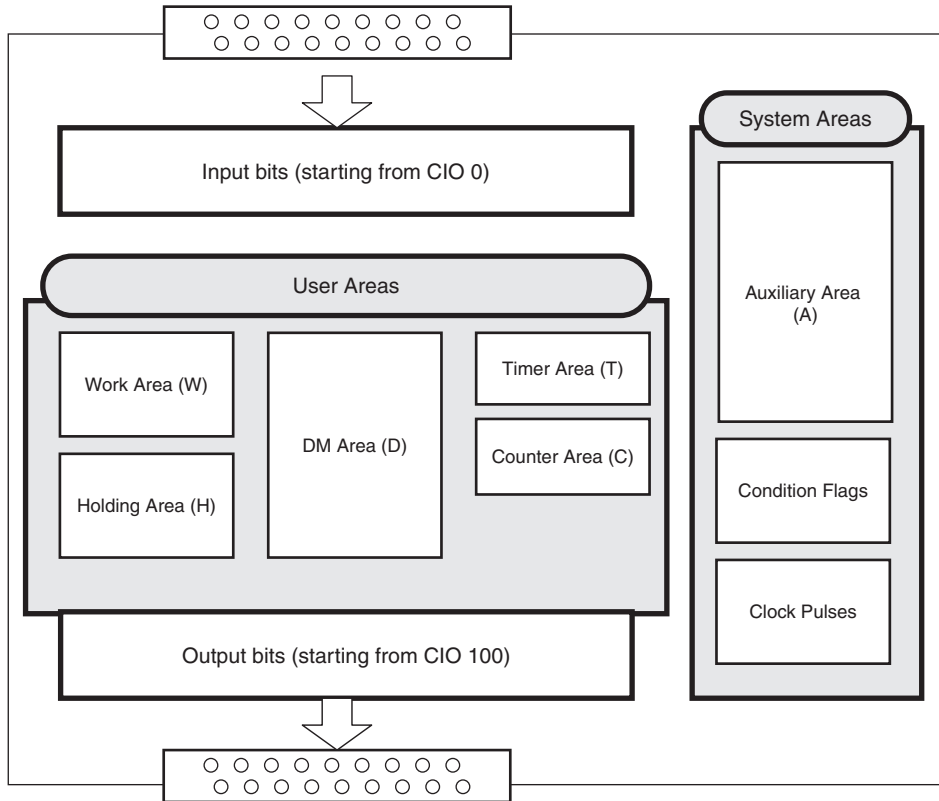

I/O Memory Areas

| Name | | No. of bits | Word addresses | Remarks |
|----------------------|--------------------------|------------------------|--------------------|---|
| CIO Area | Input Bits | 1,600 bits (100 words) | CIO 0 to CIO 99 | For NA-type, CIO90, CIO91 is occupied by analog input 0, 1. |
| | Output Bits | 1,600 bits (100 words) | CIO 100 to CIO 199 | For NA-type, CIO190 is occupied by analog output 0. |
| | Serial PLC Link Words | 1,440 bits (90 words) | CIO 200 to CIO 289 | -- |
| Work Area (W) | | 1,600 bits (100 words) | W0 to W99 | -- |
| Holding Area (H) | | 800 bits (50 words) | H0 to H49 | Data in this area is retained during power interruptions if a Battery Set (sold separately) is mounted to an N/NA□□(S□)-type CPU Unit. |
| Data Memory Area (D) | E□□(S)-type CPU Unit | 2K words | D0 to D2047 | Data in specified words of the DM Area can be retained in the built-in EEPROM in the backup memory by using a bit in the Auxiliary Area. Applicable words: D0 to D1499 (One word can be specified at a time.) |
| | N/NA□□(S□)-type CPU Unit | 8K words | D0 to D8191 | Data in specified words of the DM Area can be retained in the built-in EEPROM in the backup memory by using a bit in the Auxiliary Area. Applicable words: D0 to D6999 (One word can be specified at a time.) |
| Timer Area (T) | Present values | 256 | T0 to T255 | -- |
| | Timer Completion Flags | 256 | | -- |
| Counter Area (C) | Present values | 256 | C0 to C255 | Data in this area is retained during power interruptions if a Battery Set (sold separately) is mounted to an N/NA□□(S□)-type CPU Unit. |
| | Counter Completion Flags | 256 | | -- |
| Auxiliary Area (A) | Read only | 7168 bits (448 words) | A0 to A447 | Data in this area is retained during power interruptions if a Battery Set (sold separately) is mounted to an N/NA□□(S□)-type CPU Unit. |
| | Read-write | 4,896 bits (306 words) | A448 to A753 | |

Backing Up and Restoring DM Area Data

The contents of the DM Area (D) will become unstable if the power supply is interrupted for longer than the backup time of the built-in capacitor (50 hours for an E□□(S)-type CPU Unit, 40 hours for an N/NA□□(S□)-type CPU Unit without a Battery).
 The contents of the specified words in the DM Area data can be backed up from RAM to the built-in EEPROM backup memory during operation by turning ON a bit in the Auxiliary Area. The number of DM Area words to back up is specified in the Number of CH of DM for backup Box in the PLC Setup. If the Restore D0- from backup memory Check Box is selected in the PLC Setup, the backup data will automatically be restored to RAM when the power is turned back ON so that data is not lost even if power is interrupted.

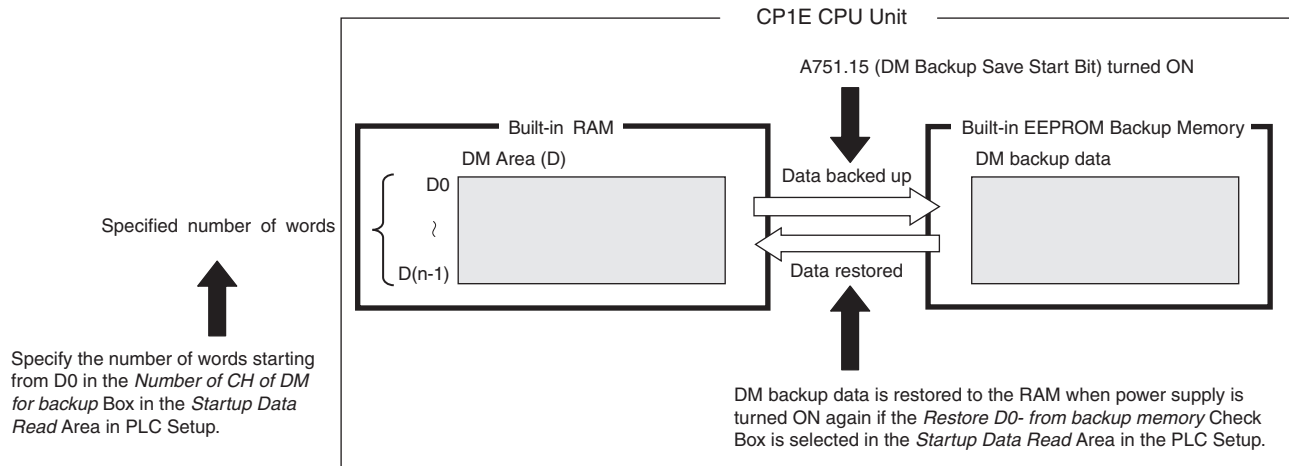

Conditions for Executing Backup

Specified words starting from D0 in the RAM can be saved to the built-in EEPROM backup memory by turning ON A751.15. (These words are called the DM backup words and the data is called the DM backup data.)
 A751.15 (DM Backup Save Start Bit) can be used in any operating mode (RUN, MONITOR, or PROGRAM mode).

Words That Can Be Backed Up

- E□□(S)-type CP1E CPU Units: D0 to D1499
- N/NA□□(S□)-type CP1E CPU Units: D0 to D6999

Number of Words To Back Up

The number of words to back up starting from D0 is set in the Number of CH of DM for backup Box in the Startup Data Read Area in the PLC Setup.

Restoring DM Backup Data to RAM When Power Is Turned ON

The DM backup data can be restored to RAM when power is turned ON by selecting the Restore D0- from backup memory Check Box in the Startup Data Read Area in the PLC Setup.
 The DM backup data will be read from the backup memory even if the Clear retained memory area (HR/DM/CNT) Check Box is selected in the PLC Setup.

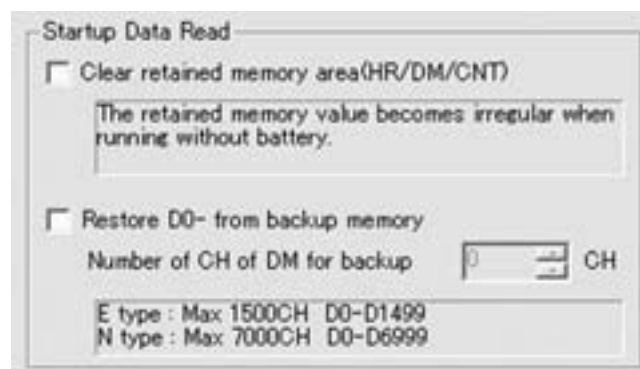

Built-in Inputs

Terminal Arrangements

●Input Terminal Arrangement for CPU Unit with 10 I/O Points

AC power supply models

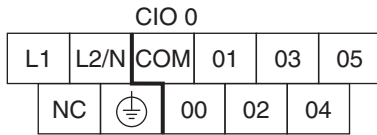

DC power supply models

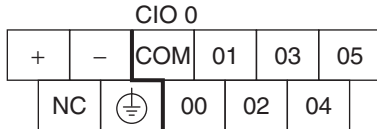

●Input Terminal Arrangement for CPU Unit with 14 I/O Points

AC power supply models

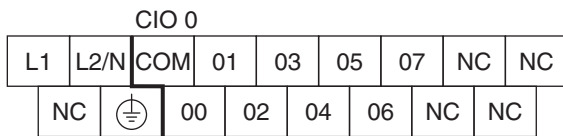

DC power supply models

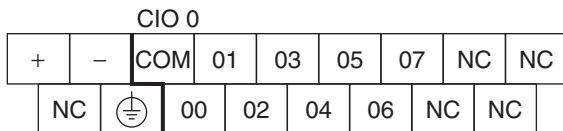

●Input Terminal Arrangement for CPU Unit with 20 I/O Points

AC power supply models

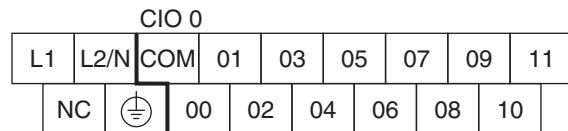

DC power supply models

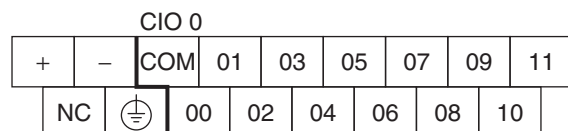

●Input Terminal Arrangement for CPU Unit with 30 I/O Points

AC power supply models

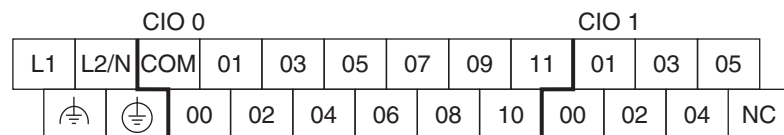

DC power supply models

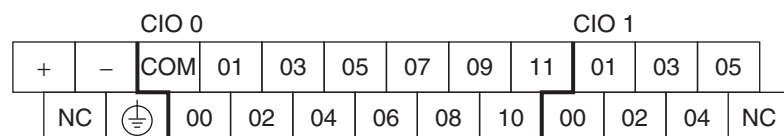

●Input Terminal Arrangement for CPU Unit with 40 I/O Points

AC power supply models

| | | | | | | | | | | | | | | | | |
|-------|------|-----|----|----|----|----|----|----|----|----|-------|----|----|----|--|--|
| CIO 0 | | | | | | | | | | | CIO 1 | | | | | |
| L1 | L2/N | COM | 01 | 03 | 05 | 07 | 09 | 11 | 01 | 03 | 05 | 07 | 09 | 11 | | |
| | | | 00 | 02 | 04 | 06 | 08 | 10 | 00 | 02 | 04 | 06 | 08 | 10 | | |

DC power supply models

| | | | | | | | | | | | | | | | | |
|-------|---|-----|----|----|----|----|----|----|----|----|-------|----|----|----|--|--|
| CIO 0 | | | | | | | | | | | CIO 1 | | | | | |
| + | - | COM | 01 | 03 | 05 | 07 | 09 | 11 | 01 | 03 | 05 | 07 | 09 | 11 | | |
| NC | | | 00 | 02 | 04 | 06 | 08 | 10 | 00 | 02 | 04 | 06 | 08 | 10 | | |

●Input Terminal Arrangement for CPU Unit with 60 I/O Points

AC power supply models

| | | | | | | | | | | | | | | | | | | | | | | |
|-------|------|-----|----|----|----|----|----|----|----|----|-------|----|----|----|----|----|-------|----|----|----|--|--|
| CIO 0 | | | | | | | | | | | CIO 1 | | | | | | CIO 2 | | | | | |
| L1 | L2/N | COM | 01 | 03 | 05 | 07 | 09 | 11 | 01 | 03 | 05 | 07 | 09 | 11 | 01 | 03 | 05 | 07 | 09 | 11 | | |
| | | | 00 | 02 | 04 | 06 | 08 | 10 | 00 | 02 | 04 | 06 | 08 | 10 | 00 | 02 | 04 | 06 | 08 | 10 | | |

DC power supply models

| | | | | | | | | | | | | | | | | | | | | | | |
|-------|---|-----|----|----|----|----|----|----|----|----|-------|----|----|----|----|----|-------|----|----|----|--|--|
| CIO 0 | | | | | | | | | | | CIO 1 | | | | | | CIO 2 | | | | | |
| + | - | COM | 01 | 03 | 05 | 07 | 09 | 11 | 01 | 03 | 05 | 07 | 09 | 11 | 01 | 03 | 05 | 07 | 09 | 11 | | |
| NC | | | 00 | 02 | 04 | 06 | 08 | 10 | 00 | 02 | 04 | 06 | 08 | 10 | 00 | 02 | 04 | 06 | 08 | 10 | | |

●Input Terminal Arrangement for CPU Unit with 20 I/O Points and Built-in Analog

AC power supply models

| | | | | | | | | | | | | | | |
|-------|------|-----|----|----|----|----|----|----|-------|------|--------|------|--------|--|
| CIO 0 | | | | | | | | | | | CIO 90 | | CIO 91 | |
| L1 | L2/N | COM | 01 | 03 | 05 | 07 | 09 | 11 | I IN0 | AG | I IN1 | | | |
| | | | 00 | 02 | 04 | 06 | 08 | 10 | VIN0 | COM0 | VIN1 | COM1 | | |

DC power supply models

| | | | | | | | | | | | | | | |
|-------|---|-----|----|----|----|----|----|----|-------|------|--------|------|--------|--|
| CIO 0 | | | | | | | | | | | CIO 90 | | CIO 91 | |
| + | - | COM | 01 | 03 | 05 | 07 | 09 | 11 | I IN0 | AG | I IN1 | | | |
| NC | | | 00 | 02 | 04 | 06 | 08 | 10 | VIN0 | COM0 | VIN1 | COM1 | | |

Allocating Built-in Inputs to Functions

Input terminals are allocated functions by setting parameters in the PLC Setup. Set the PLC Setup so that each terminal is used for only one function.

| CPU Unit with I/O Points | Input terminal block | | Settings in PLC Setup | | | | | | | |
|--------------------------|----------------------|-----------------|--|----------------------|------------------------|--|--|-----------------------------|---|--|
| | | | Interrupt input setting on Built-in Input Tab Page | | | High-speed counter 0 to 3 setting on Built-in Input Tab Page | | | Origin search settings on Pulse Output 0/1 Tab Page | |
| | Terminal block label | Terminal number | Normal | Interrupt | Quick | Single-phase (increment pulse input) | Two-phase (differential phase x4 or up/down) | Two-phase (pulse/direction) | CPU Unit with 20 to 60 points | CPU Unit with 14 I/O points |
| Normal input | | | Input interrupt | Quick-response input | | | | | | |
| 10 | CIO 0 | 00 | Normal input 0 | -- | -- | Counter 0, increment input | Counter 0, phase A or up input | Counter 0, pulse input | -- | -- |
| | | 01 | Normal input 1 | -- | -- | Counter 1, increment input | Counter 0, phase B or down input | Counter 1, pulse input | -- | -- |
| | | 02 | Normal input 2 | Interrupt input 2 | Quick-response input 2 | Counter 2, increment input | Counter 1, phase A or up input | Counter 0, direction | -- | -- |
| | | 03 | Normal input 3 | Interrupt input 3 | Quick-response input 3 | -- | Counter 1, phase B or down input | Counter 1, direction | -- | Pulse 0, Origin proximity input signal |
| | | 04 | Normal input 4 | Interrupt input 4 | Quick-response input 4 | Counter 3, increment input | Counter 0, phase Z or reset input | Counter 0, reset input | -- | -- |
| | | 05 | Normal input 5 | Interrupt input 5 | Quick-response input 5 | Counter 4, increment input | Counter 1, phase Z or reset input | Counter 1, reset input | -- | Pulse 1, Origin proximity input signal |
| | | 06 | Normal input 6 | Interrupt input 6 | Quick-response input 6 | Counter 5, increment input | -- | -- | Pulse 0: Origin input signal | Pulse 0, Origin input signal |
| | | 07 | Normal input 7 | Interrupt input 7 | Quick-response input 7 | -- | -- | -- | Pulse 1: Origin input signal | Pulse 1, Origin input signal |
| | | 08 | Normal input 8 | -- | -- | -- | -- | -- | -- | -- |
| | | 09 | Normal input 9 | -- | -- | -- | -- | -- | -- | -- |
| | | 10 | Normal input 10 | -- | -- | -- | -- | -- | Pulse 0: Origin proximity input signal | -- |
| 14 | CIO 0 | 11 | Normal input 11 | -- | -- | -- | -- | -- | Pulse 1: Origin proximity input signal | -- |
| | | 00 to 05 | Normal input 12 to 17 | -- | -- | -- | -- | -- | -- | -- |
| 20 | CIO 0 | 06 to 11 | Normal input 18 to 23 | -- | -- | -- | -- | -- | -- | -- |
| | | 00 to 11 | Normal input 24 to 35 | -- | -- | -- | -- | -- | -- | -- |
| 30 | CIO 1 | 00 to 05 | Normal input 12 to 17 | -- | -- | -- | -- | -- | -- | -- |
| 40 | | 06 to 11 | Normal input 18 to 23 | -- | -- | -- | -- | -- | -- | -- |
| 60 | CIO 2 | 00 to 11 | Normal input 24 to 35 | -- | -- | -- | -- | -- | -- | -- |

These functions are supported only by N/NA□□(S□)-type CPU Units with transistor outputs.

Built-in Outputs

Terminal Arrangements

●Output Terminal Arrangement for CPU Unit with 10 I/O Points

AC power supply model
DC power supply model

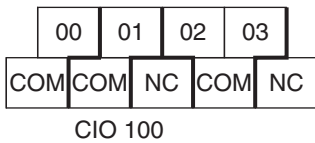

●Output Terminal Arrangement for CPU Unit with 14 I/O Points

AC power supply model
DC power supply model

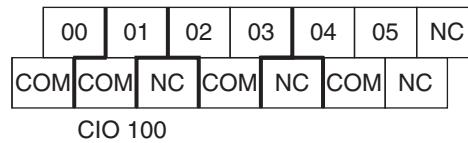

●Output Terminal Arrangement for CPU Unit with 20 I/O Points

AC power supply model
DC power supply model

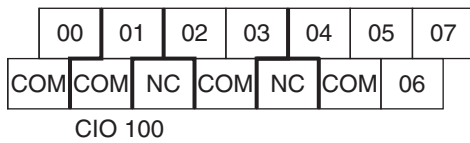

●Output Terminal Arrangement for CPU Unit with 30 I/O Points

AC power supply model
E/N30(S□)D□-A

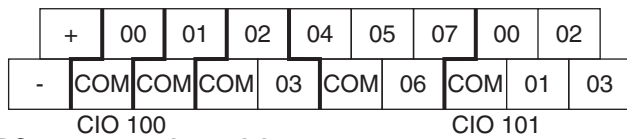

DC power supply model
N30D□-D

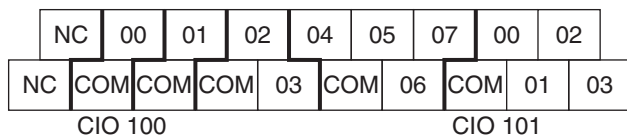

N30S(1)DT-D

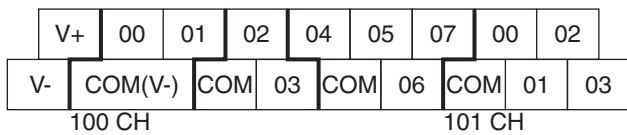

Note: V- and COM(V-) are internally connected.

N30S(1)DT1-D

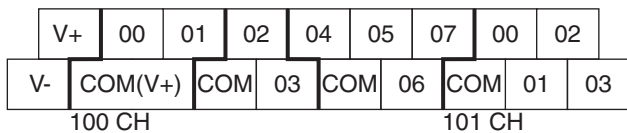

Note: V+ and COM(V+) are internally connected.

●Output Terminal Arrangement for CPU Unit with 40 I/O Points

AC power supply model

E/N40(S□)D□-A

| | | | | | | | | | | | |
|---------|-----|-----|-----|-----|----|---------|-----|----|-----|----|----|
| + | 00 | 01 | 02 | 03 | 04 | 06 | 00 | 01 | 03 | 04 | 06 |
| - | COM | COM | COM | COM | 05 | 07 | COM | 02 | COM | 05 | 07 |
| CIO 100 | | | | | | CIO 101 | | | | | |

DC power supply model

N40D□-D

| | | | | | | | | | | | |
|---------|-----|-----|-----|-----|----|---------|-----|----|-----|----|----|
| NC | 00 | 01 | 02 | 03 | 04 | 06 | 00 | 01 | 03 | 04 | 06 |
| NC | COM | COM | COM | COM | 05 | 07 | COM | 02 | COM | 05 | 07 |
| CIO 100 | | | | | | CIO 101 | | | | | |

N40S(1)DT-D

| | | | | | | | | | | | |
|--------|---------|-----|-----|----|----|--------|----|-----|----|----|----|
| V+ | 00 | 01 | 02 | 03 | 04 | 06 | 00 | 01 | 03 | 04 | 06 |
| V- | COM(V-) | COM | COM | 05 | 07 | COM | 02 | COM | 05 | 07 | |
| 100 CH | | | | | | 101 CH | | | | | |

Note: V- and COM(V-) are internally connected.

N40S(1)DT1-D

| | | | | | | | | | | | |
|--------|---------|-----|-----|----|----|--------|----|-----|----|----|----|
| V+ | 00 | 01 | 02 | 03 | 04 | 06 | 00 | 01 | 03 | 04 | 06 |
| V- | COM(V+) | COM | COM | 05 | 07 | COM | 02 | COM | 05 | 07 | |
| 100 CH | | | | | | 101 CH | | | | | |

Note: V+ and COM(V+) are internally connected.

●Output Terminal Arrangement for CPU Unit with 60 I/O Points

AC power supply model

E/N60(S□)D□-A

| | | | | | | | | | | | | | | | | |
|---------|-----|-----|-----|----|---------|----|-----|----|----|-----|---------|-----|----|----|-----|----|
| + | 00 | 01 | 02 | 04 | 05 | 07 | 00 | 02 | 04 | 05 | 07 | 00 | 02 | 04 | 05 | 07 |
| - | COM | COM | COM | 03 | COM | 06 | COM | 01 | 03 | COM | 06 | COM | 01 | 03 | COM | 06 |
| CIO 100 | | | | | CIO 101 | | | | | | CIO 102 | | | | | |

DC power supply model

N60D□-D

| | | | | | | | | | | | | | | | | |
|---------|-----|-----|-----|----|---------|----|-----|----|----|-----|---------|-----|----|----|-----|----|
| NC | 00 | 01 | 02 | 04 | 05 | 07 | 00 | 02 | 04 | 05 | 07 | 00 | 02 | 04 | 05 | 07 |
| NC | COM | COM | COM | 03 | COM | 06 | COM | 01 | 03 | COM | 06 | COM | 01 | 03 | COM | 06 |
| CIO 100 | | | | | CIO 101 | | | | | | CIO 102 | | | | | |

N60S(1)DT-D

| | | | | | | | | | | | | | | | | |
|--------|---------|-----|----|-----|--------|-----|----|----|-----|----|--------|----|----|-----|----|----|
| V+ | 00 | 01 | 02 | 04 | 05 | 07 | 00 | 02 | 04 | 05 | 07 | 00 | 02 | 04 | 05 | 07 |
| V- | COM(V-) | COM | 03 | COM | 06 | COM | 01 | 03 | COM | 06 | COM | 01 | 03 | COM | 06 | |
| 100 CH | | | | | 101 CH | | | | | | 102 CH | | | | | |

Note: V- and COM(V-) are internally connected.

N60S(1)DT1-D

| | | | | | | | | | | | | | | | | |
|--------|---------|-----|----|-----|--------|-----|----|----|-----|----|--------|----|----|-----|----|----|
| V+ | 00 | 01 | 02 | 04 | 05 | 07 | 00 | 02 | 04 | 05 | 07 | 00 | 02 | 04 | 05 | 07 |
| V- | COM(V+) | COM | 03 | COM | 06 | COM | 01 | 03 | COM | 06 | COM | 01 | 03 | COM | 06 | |
| 100 CH | | | | | 101 CH | | | | | | 102 CH | | | | | |

Note: V+ and COM(V+) are internally connected.

●Output Terminal Arrangement for CPU Unit with 20 I/O Points and Built-in Analog

AC power supply model

DC power supply model

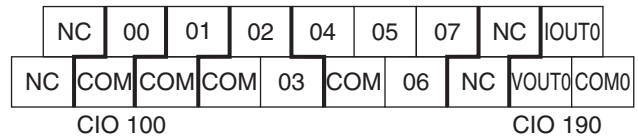
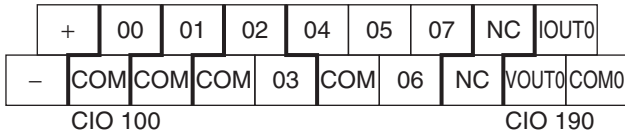

Allocating Built-in Output Terminals to Functions

Output terminals are allocated functions by setting parameters in the PLC Setup. Set the PLC Setup so that each terminal is used for only one function.

| CPU Unit with I/O points | Output terminal block | | Other than those shown right | When a pulse output instruction (SPED, ACC, PLS2, or ORG) is executed | Setting in PLC Setup Origin search setting on Pulse Output 0/1 Tab Page | When the PWM instruction is executed |
|--------------------------|-----------------------|-----------------|------------------------------|---|--|--------------------------------------|
| | Terminal block label | Terminal number | Normal output | Fixed duty ratio pulse output | | Variable duty ratio pulse output |
| | | | | Pulse + direction | Use | PWM output |
| 10 14 20 | CIO 100 | 00 | Normal output 0 | Pulse output 0 (pulse) | -- | -- |
| | | 01 | Normal output 1 | Pulse output 1 (pulse) | -- | PWM output 0 |
| | | 02 | Normal output 2 | Pulse output 0 (direction) | -- | -- |
| | | 03 | Normal output 3 | Pulse output 1 (direction) | -- | -- |
| | | 04 | Normal output 4 | -- | Pulse 0: Error counter reset output | -- |
| | | 05 | Normal output 5 | -- | Pulse 1: Error counter reset output | -- |
| | | 06 | Normal output 6 | -- | -- | -- |
| 30 40 | CIO 101 | 00 to 03 | Normal output 8 to 11 | -- | -- | -- |
| | | 04 to 07 | Normal output 12 to 15 | -- | -- | -- |
| 60 | CIO 102 | 00 to 07 | Normal output 16 to 23 | -- | -- | -- |

These functions are supported only by N/NA□□(S□)-type CPU Units with transistor outputs.

I/O Specifications for CPU Units

Input Specifications

| Item | Specification | | |
|----------------------|---|---|--|
| Input type | High-speed counter inputs or Normal Inputs | High-speed counter inputs, interrupt input, quick-response inputs, or Normal Inputs | Normal inputs |
| Input bits | CIO 0.00 to CIO 0.01 | CIO 0.02 to CIO 0.07 *1 | CIO 0.08 to CIO 0.11, CIO 1.00 to CIO 1.11 and CIO 2.00 to CIO 2.11 *1 |
| Input voltage | 24 VDC, +10%, -15% | | |
| Applicable sensors | 2-wire and 3-wire sensors | | |
| Input Impedance | 3.3 kΩ | 3.3 kΩ | 4.8 kΩ |
| Input current | 7.5 mA typical | 7.5 mA typical | 5 mA typical |
| ON voltage/current | 3 mA min. at 17.0 VDC min. | 3 mA min. at 17.0 VDC min. | 3 mA min. at 14.4 VDC min. |
| OFF voltage/current | 1 mA max. at 5.0 VDC max. | 1 mA max. at 5.0 VDC max. | 1 mA max. at 5.0 VDC max. |
| ON response time *2 | E□□(S)-type CPU Unit: 50 μs min. N/NA□□(S□)-type CPU Unit: 2.5 μs min. | 50 μs max. | 1 ms max. |
| OFF response time *2 | E□□(S)-type CPU Unit: 50 μs min. N/NA□□(S□)-type CPU Unit: 2.5 μs min. | 50 μs max. | 1 ms max. |

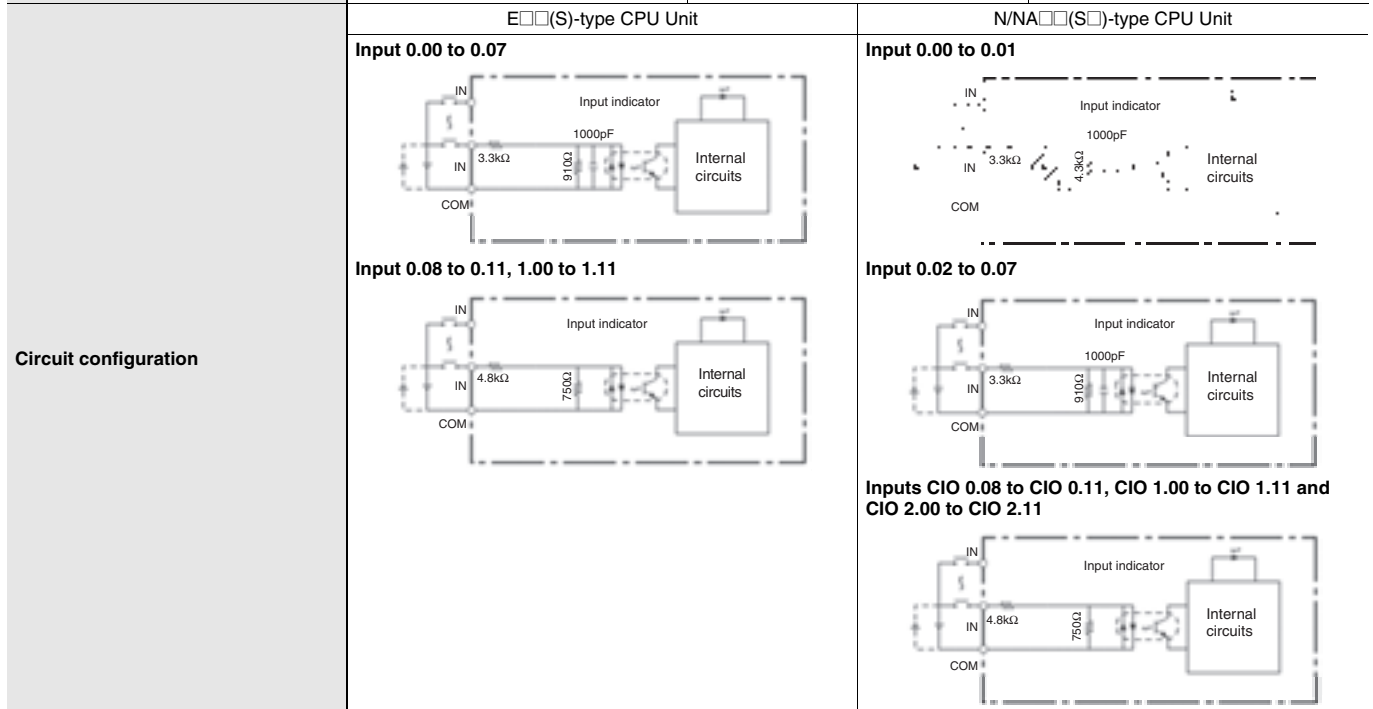

* 1 The bits that can be used depend on the model of CPU Unit.

* 2 The response time is the delay caused by hardware. The delay set in the PLC Setup (0 to 32 ms, default: 8 ms) for a normal input must be added to this value.

Pulse plus direction input mode,
Increment mode
Up/down input mode

Differential phase mode

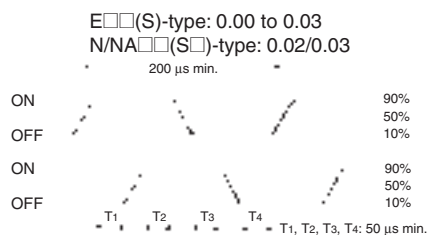
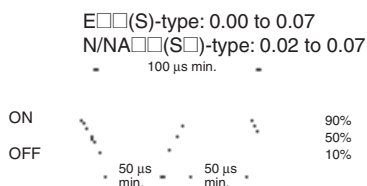
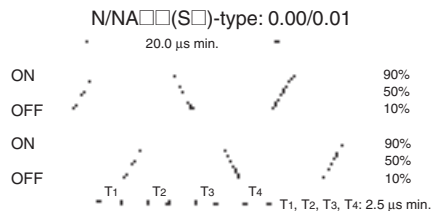
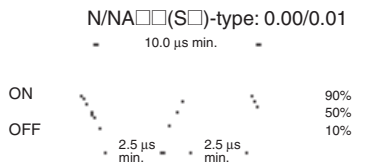

Output Specifications

●Output Specifications for Relay Outputs

| Item | | Specification |
|----------------------------|------------|--|
| Maximum switching capacity | | 250 VAC/2 A (cosφ = 1) 2 A, 24 VDC (4 A/common) |
| Minimum switching capacity | | 5 VDC, 10 mA |
| Service life of relay | Electrical | Resistive load 200,000 operations (24 VDC) Inductive load 70,000 operations (250 VAC, cosφ = 0.4) |
| | Mechanical | 20,000,000 operations |
| ON delay | | 15 ms max. |
| OFF response time | | 15 ms max. |
| Circuit configuration | | |

Estimating the Service Life of Relays

Under normal conditions, the service life of output contacts is as shown above. The service life of relays is as shown in the following diagram as a guideline

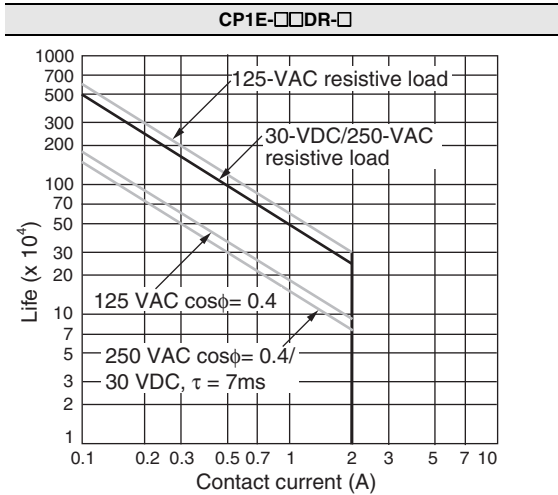

Relationship between Continuous Simultaneous ON Rate and Ambient Temperature

There are restrictions on the power supply voltage and output load current imposed by the ambient temperature. Make sure that the power supply voltage and output load current are within the following ranges.

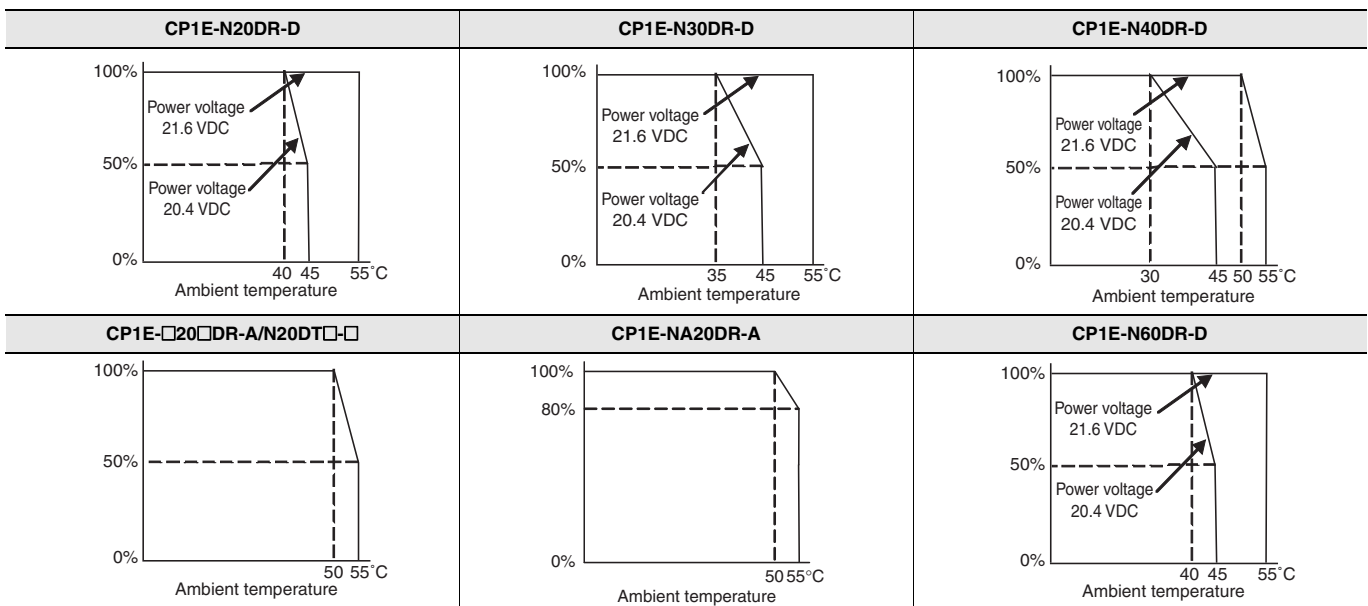

Note: The above restrictions apply to the relay output load current from the CPU Unit even if Expansion I/O Units are not connected.

●Output Specifications for Transistor Outputs (Sinking or Sourcing)

Normal Outputs

| Item | Specification | | |
|----------------------------|--|----------|---|
| | N□□(S□)-type 100.00, 100.01 | | N□□(S□)-type 100.02 to 102.07 *2 E10-type 100.00 to 100.03 |
| | N□□S(1)-type | N□□-type | |
| Maximum switching capacity | 0.3 A/output, 0.9 A/common *1 4.5 to 30 VDC CP1E-E10D□-□: 0.9 A/Unit CP1E-N40(S□)D□-□: 3.6 A/Unit CP1E-N14D□-□: 1.5 A/Unit CP1E-N60(S□)D□-□: 5.4 A/Unit CP1E-N20D□-□: 1.8 A/Unit CP1E-NA20D□-□: 1.8 A/Unit CP1E-N30(S□)D□-□: 2.7 A/Unit | | |
| Minimum switching capacity | 1 mA 4.5 to 30 VDC | | |
| Leakage current | 0.1mA max. | | |
| Residual voltage | 0.6 V max. | | 1.5V max. |
| ON response time | 0.1 ms max. | | 0.1 ms max. |
| OFF response time | 0.1 ms max. | | 1 ms max. |
| Fuse | Not provided. | | |
| External Power Supply | 20.4 to 26.4V VDC 30mA max. | None | None |

| Circuit configuration | N□□S(1)-type sinking | | sinking | |
|-----------------------|----------------------|--|---------|--|
| | | | | |
| | N/NA□□-type sinking | | | |
| | | | | |

Note: Do not connect a load to an output terminal or apply a voltage in excess of the maximum switching capacity.
 * 1 Also do not exceed 0.9 A for the total for CIO 100.00 to CIO 100.03. (CIO 100.00 to CIO 100.03 is different common.)
 * 2 The bits that can be used depend on the model of CPU Unit.

Pulse Outputs (CIO 100.00 and CIO 100.01)

| Item | Specification |
|----------------------------|------------------------|
| Maximum switching capacity | 100 mA/4.5 to 26.4 VDC |
| Minimum switching capacity | 7 mA/4.5 to 26.4 VDC |
| Maximum output frequency | 100 kHz |
| Output waveform | |

Note: 1. The load for the above values is assumed to be the resistance load, and does not take into account the impedance for the connecting cable to the load.
 2. Due to distortions in pulse waveforms resulting from connecting cable impedance, the pulse widths in actual operation may be smaller than the values shown above.
 3. The OFF and ON refer to the output transistor. The output transistor is ON at level "L".

PWM Output (CIO 100.01)

| Item | Specification |
|----------------------------|---|
| Maximum switching capacity | 30 mA/4.5 to 26.4 VDC |
| Maximum output frequency | 32 kHz |
| PWM output accuracy | For ON duty +1%, .0%: 10 kHz output For ON duty +5%, .0%: 0 to 32 kHz output |
| Output waveform | <p>ON duty = $\frac{t_{ON}}{T} \times 100\%$</p> |

Note: The OFF and ON refer to the output transistor. The output transistor is ON at level “L”.

Built-in Analog I/O (NA-type CPU Units)

● **Analog Input Specifications**

| Item | Voltage input | Current input |
|---------------------------------|---|-----------------------------|
| Number of inputs | 2 inputs (Allocated 2 words: CIO 90 to CIO 91.) | |
| Input signal range | 0 to 5 V, 1 to 5 V, 0 to 10 V, or -10 to 10 V | 0 to 20 mA or 4 to 20 mA |
| Max. rated input | ±15 V | ±30 mA |
| External input impedance | 1 MΩ min. | Approx. 250Ω |
| Resolution | 1/6000 | |
| Overall accuracy | At 25°C | ±0.3% full scale |
| | 0 to 55°C | ±0.6% full scale |
| A/D conversion data | -10 to +10 V | F448 to 0BB8 hex Full Scale |
| | Other ranges | 0000 to 1770 hex Full Scale |
| Averaging function | Supported (Set for individual inputs in the PLC Setup.) | |
| Open-circuit detection function | Supported (Value when disconnected: 8000 hex) | |

● **Analog Output Specifications**

| Item | Voltage output | Current output |
|---|---|-----------------------------|
| Number of outputs | 1 output (Allocated 1 word: CIO 190.) | |
| Output signal range | 0 to 5 V, 1 to 5 V, 0 to 10 V, or -10 to 10 V | 0 to 20 mA or 4 to 20 mA |
| Allowable external output load resistance | 1 kΩ min. | 600Ω max. |
| External input impedance | 0.5Ω max. | --- |
| Resolution | 1/6000 | |
| Overall accuracy | At 25°C | ±0.4% full scale * |
| | 0 to 55°C | ±0.8% full scale * |
| D/A conversion data | -10 to +10 V | F448 to 0BB8 hex Full Scale |
| | Other ranges | 0000 to 1770 hex Full Scale |

* In 0 to 20 mA mode, accuracy cannot be ensured at 0.2 mA or less.

● **Shared I/O Specifications**

| Item | Specification |
|------------------|--|
| Conversion time | 2 ms/point (6 ms total for 2 analog inputs and 1 analog output.) |
| Isolation method | Photocoupler isolation between analog I/O terminals and internal circuits. No isolation between analog I/O signals. |

Specifications of Expansion I/O Units and Expansion Units

Expandable CPU Units

- Expansion I/O Units and Expansion Units cannot be connected to E10/14/20(S) or N14/20 CPU Units.
- A total of up to three Expansion I/O Units and Expansion Units can be connected to an E30/40/60(S), N30/40/60(S□), NA20 CPU Unit.

●CP1E E10/14/20(S) or N14/20CPU Unit

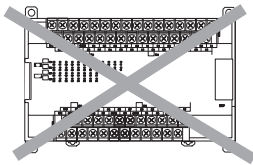
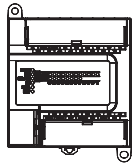

CP-series Expansion Units and Expansion I/O Units cannot be connected.

●CP1E E30/40(S), N30/40/60(S□) or NA20 CPU Unit

A total of up to three CP-series Expansion I/O Units and Expansion Units can be connected.

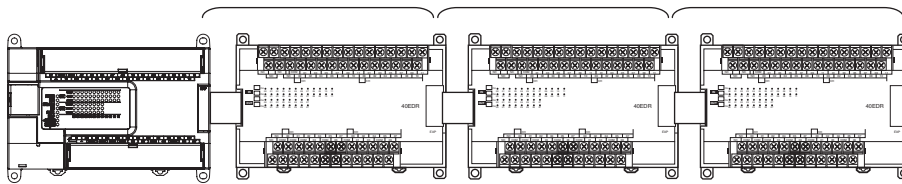

Connection Methods

Connection cables for the Expansion I/O Units and Expansion Units are used to connect the Units. The length can be extended by using a CP1W-CN811 I/O Connection Cable (length: 800 m).

Maximum Number of I/O Points for an Expanded System

| CPU Unit | Built-in I/O on CPU Unit | | | Built-in Analog | | Total number of Expansion I/O Units and Expansion Units that can be connected | Number of inputs: 24 Number of outputs: 16 Total number of I/O points when three CP1W-40ED□ Expansion I/O Units are connected | | |
|---------------|--------------------------|------------------|-------------------|-----------------|------|---|---|------------------|-------------------|
| | Total | Number of inputs | Number of outputs | AD | DA | | Total | Number of inputs | Number of outputs |
| CP1E-E10D□-□ | 10 | 6 | 4 | None | None | Not possible. | 10 | 6 | 4 |
| CP1E-□14□D□-□ | 14 | 8 | 6 | | | | 14 | 8 | 6 |
| CP1E-□20□D□-□ | 20 | 12 | 8 | | | | 20 | 12 | 8 |
| CP1E-□30□D□-□ | 30 | 18 | 12 | | | 3 Units maximum | 150 | 90 | 60 |
| CP1E-□40□D□-□ | 40 | 24 | 16 | | | | 160 | 96 | 64 |
| CP1E-□60□D□-□ | 60 | 36 | 24 | | | | 180 | 108 | 72 |
| CP1E-NA20D□-□ | 20 | 12 | 8 | 2 | 1 | | 140 | 84 | 56 |

Restrictions on External Power Supply Capacity

The following restrictions apply when using the CPU Unit's external power supply.

●AC-power-supply E30/40(S), N30/40/60(S□) or NA20 CPU Unit

The power supply capacity is restricted for AC-power-supply E30/40/60(S), N30/40/60(S□), NA20 CPU Units. It may not be possible to use the full 300 mA of the external power supply, though a CPU Unit can connect any CP-series Expansion I/O Unit or Expansion Unit.

The entire 300 mA from the external power supply can be used if Expansion Units and Expansion I/O Units are not connected.

Refer to the CP1E CPU Unit Hardware Manual (Cat. No. W479) for details.

●AC-power-supply or DC-power-supply E10/14/20(S), N14/20(S) CPU Unit

There is no external power supply on AC-power-supply or DC-power-supply E10/14/20, N14/20 CPU Units.

Specifications of Expansion I/O Units

●Input Specifications (CP1W-40EDR/40EDT/40EDT1/20EDR1/20EDT/20EDT1/8ED)

| Item | Specification |
|-----------------|------------------|
| Input voltage | 24 VDC +10%/-15% |
| Input impedance | 4.7 kΩ |
| Input current | 5 mA typical |
| ON voltage | 14.4 VDC min. |
| OFF voltage | 5.0 VDC max. |
| ON delay | 1 ms max. * |
| OFF delay | 1 ms max. * |

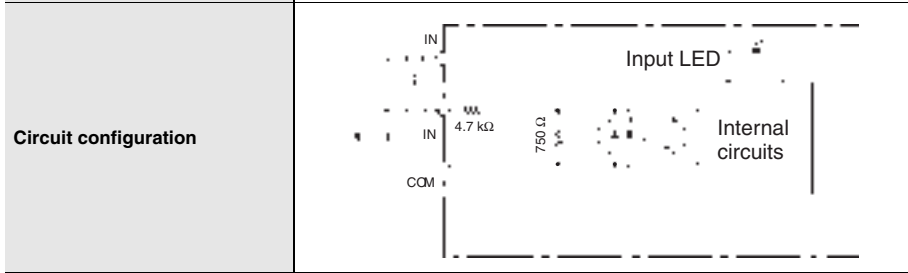

Note: Do not apply voltage in excess of the rated voltage to the input terminal.

* The response time is the hardware delay value. The delay set in the PLC Setup (0 to 32 ms, default: 8 ms) must be added to this value. For the CP1W-40EDR/EDT/EDT1, a fixed value of 16 ms must be added.

●Output Specifications Relay Outputs (CP1W-40EDR/32ER/20EDR1/16ER/8ER)

| Item | Specification |
|--------------------------------------|--|
| Max. switching capacity | 2 A, 250 VAC ($\cos\phi = 1$), 2 A, 24 VDC (4 A/common) |
| Min. switching capacity | 5 VDC, 10 mA |
| Service life of relay (See note.) | Electrical |
| | Mechanical |
| Resistive load | 150,000 operations (24 VDC) |
| Inductive load | 100,000 operations (240 VAC, $\cos\phi = 0.4$) |
| ON delay | 15 ms max. |
| OFF delay | 15 ms max. |

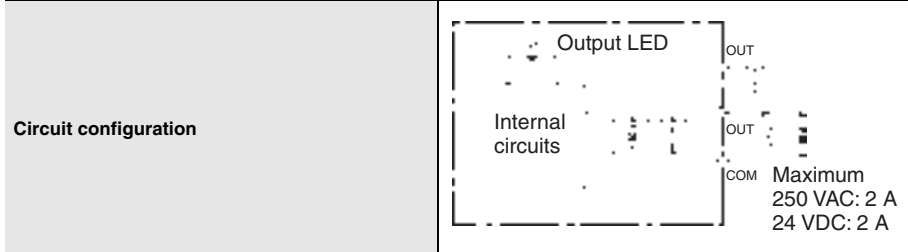

Note: 1. Estimating the Service Life of Relays

The service life of output contacts is as shown in the following diagram.

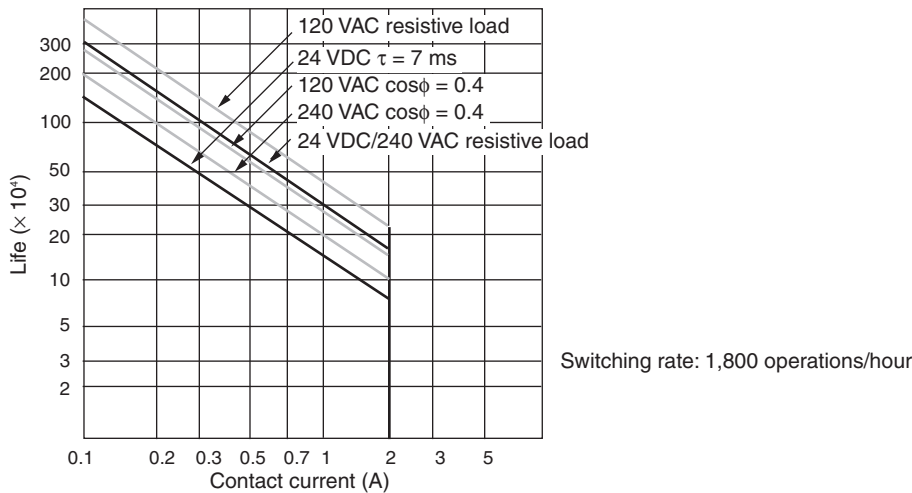

2. Restrictions of CP1W-16ER/32ER

Limit the output load current to satisfy the following derating curve.

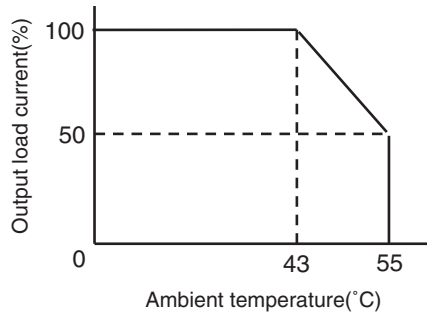

3. CP1W-32ER's maximum number of simultaneously ON output points is 24 (75%).
Relation between Number of ON Outputs and Ambient Temperature (CP1W-32ER)

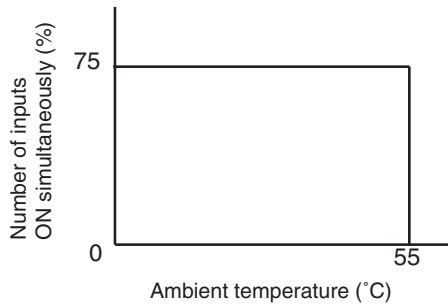

4. According to the ambient temperature, there are restrictions on power supply voltage and output load current for the CPU Units connected with the Expansion I/O Units (CP1W-8ER/16ER/20EDR1/32ER/40EDR). Use the PLC in the range of the power supply voltage and output load current as show below.
The ambient temperature is restricted for the power-supply CPU Units (CP1E-N/NA□□□□-□). Derating curve of the output load current for Expansion I/O Units (CP1W-8ER/16ER/20EDR1/32ER/40EDR).

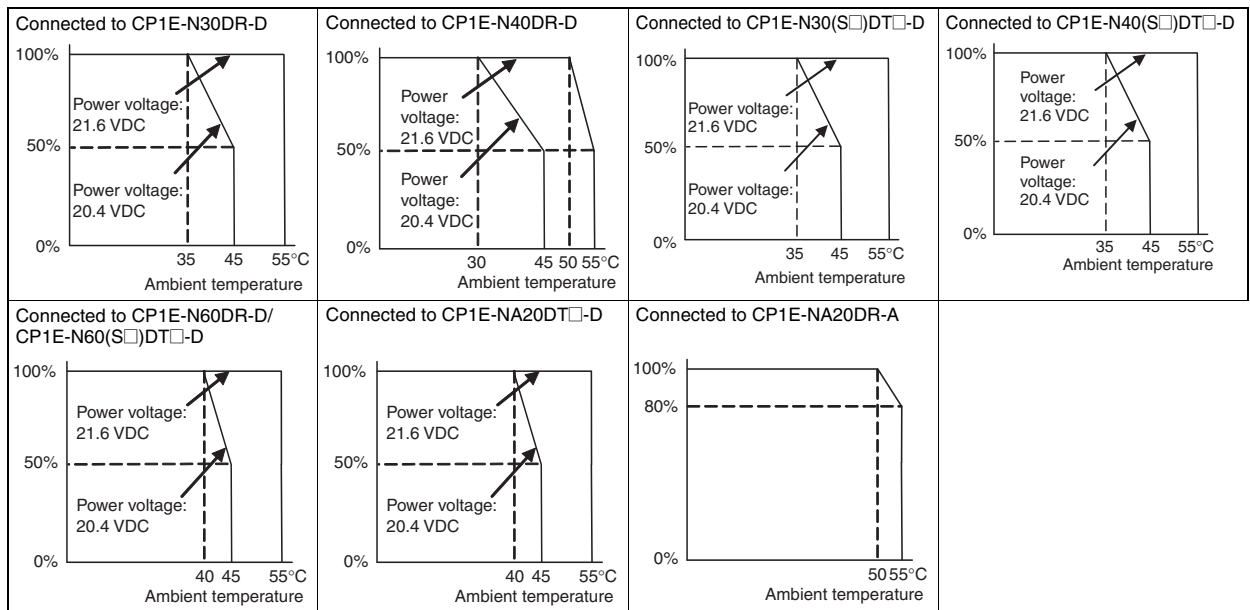

●Transistor Outputs (Sinking or Sourcing)

| Item | Specification | | | | |
|--|---|---|---|---|---|
| | CP1W-40EDT CP1W-40EDT1 | CP1W-32ET CP1W-32ET1 | CP1W-20EDT CP1W-20EDT1 | CP1W-16ET CP1W-16ET1 | CP1W-8ET CP1W-8ET1 |
| Max. switching capacity *1 | 4.5 to 30 VDC 0.3 A/output 0.9 A/common 3.6 A/Unit | 4.5 to 30 VDC 0.3 A/output 0.9 A/common 7.2 A/Unit | 24 VDC +10%/-5% 0.3 A/output 0.9 A/common 1.8 A/Unit | 4.5 to 30 VDC 0.3 A/output 0.9 A/common 3.6 A/Unit | 4.5 to 30 VDC 0.3 A/output 0.9 A/common 1.8 A/Unit |
| Leakage current | 0.1 mA max. | 0.1 mA max. | 0.1 mA max. | 0.1 mA max. | 0.1 mA max. |
| Residual voltage | 1.5 V max. | 1.5 V max. | 1.5 V max. | 1.5 V max. | 1.5 V max. |
| ON delay | 0.1 ms max. | 0.1 ms max. | 0.1 ms. | 0.1 ms max. | 0.1 ms max. |
| OFF delay | 1 ms max. 24 VDC +10%/-5% 5 to 300 mA | 1 ms max. 24 VDC +10%/-5% 5 to 300 mA | 1 ms max. 24 VDC +10%/-5% 5 to 300 mA | 1 ms max. 24 VDC +10%/-5% 5 to 300 mA | 1 ms max. 24 VDC +10%/-5% 5 to 300 mA |
| Max. number of Simultaneously ON Points of Output | 16 pts (100%) | 24 pts (75%) | 8 pts (100%) | 16 pts (100%) | 8 pts (100%) |
| Fuse *2 | 1 fuse/common | | | | |

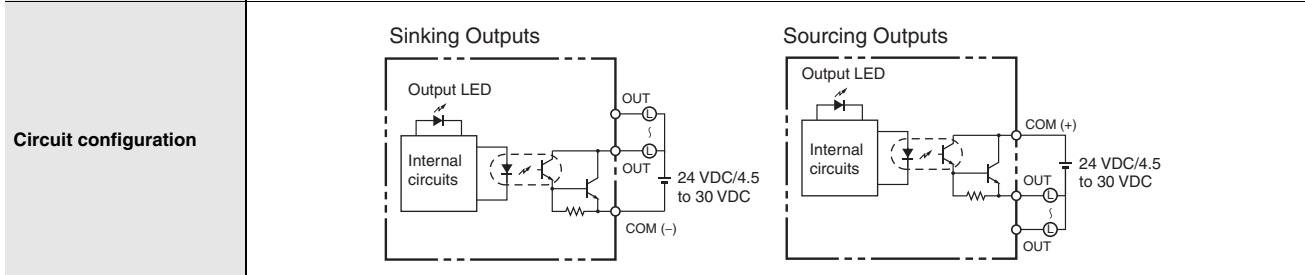

*1 If the ambient temperature is maintained below 50°C, up to 0.9 A/common can be used.

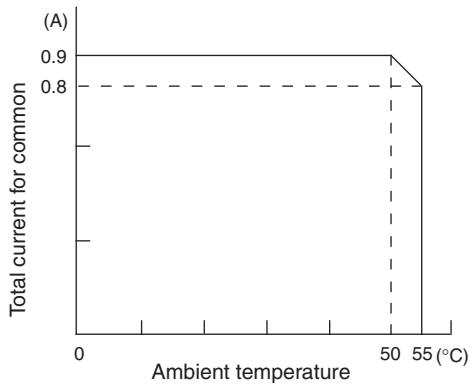

*2 The fuse cannot be replaced by the user. Replace the Unit if the fuse breaks due to a short-circuit or overcurrent.

*3 Do not connect a load to an output terminal or apply a voltage in excess of the maximum switching capacity.

Specifications of Expansion Units

●Analog Input Units

| Model | | CP1W-AD041 | | CP1W-AD042 | |
|---------------------------------|-----------|--|--------------------------|--|--------------------------|
| Item | | Voltage Input | Current Input | Voltage Input | Current Input |
| Number of inputs | | 4 inputs (4 words allocated) | | | |
| Input signal range | | 0 to 5 VDC, 1 to 5 VDC, 0 to 10 VDC, or -10 to 10 VDC | 0 to 20 mA or 4 to 20 mA | 0 to 5 VDC, 1 to 5 VDC, 0 to 10 VDC, or -10 to 10 VDC | 0 to 20 mA or 4 to 20 mA |
| Max. rated input | | ±15 V | ±30 mA | ±15 V | ±30 mA |
| External input impedance | | 1 MΩ min. | Approx. 250 Ω | 1 MΩ min. | Approx. 250 Ω |
| Resolution | | 1/6000 (full scale) | | 1/12000 (full scale) | |
| Overall accuracy | 25°C | 0.3% full scale | 0.4% full scale | 0.2% full scale | 0.3% full scale |
| | 0 to 55°C | 0.6% full scale | 0.8% full scale | 0.5% full scale | 0.7% full scale |
| A/D conversion data | | 16-bit binary (4-digit hexadecimal) Full scale for -10 to 10 V: F448 to 0BB8 Hex Full scale for other ranges: 0000 to 1770 Hex | | 16-bit binary (4-digit hexadecimal) Full scale for -10 to 10 V: E890 to 1770 Hex Full scale for other ranges: 0000 to 2EE0 Hex | |
| Averaging function | | Supported (Set in output words n+1 and n+2.) | | | |
| Open-circuit detection function | | Supported | | | |
| Conversion time | | 2 ms/point (8 ms/all points) | | 1 ms/point (4 ms/all points) | |
| Isolation method | | Photocoupler isolation between analog I/O terminals and internal circuits. No isolation between analog I/O signals. | | | |
| Current consumption | | 5 VDC: 100 mA max.; 24 VDC: 90 mA max. | | 5 VDC: 100 mA max.; 24 VDC: 50 mA max. | |

●Analog Output Units

| Model | | CP1W-DA021/CP1W-DA041 | | CP1W-DA042 | | |
|-----------------------|--|--|--|--|--------------------------|--|
| Item | | Voltage Output | Current Output | Voltage Input | Current Input | |
| Analog output section | Number of outputs | CP1W-DA021: 2 outputs (2 words allocated) CP1W-DA041: 4 outputs (4 words allocated) | | 4 outputs (4 words allocated) | | |
| | Output signal range | 1 to 5 VDC, 0 to 10 VDC, or -10 to 10 VDC | 0 to 20 mA or 4 to 20 mA | 1 to 5 VDC, 0 to 10 VDC, or -10 to 10 VDC | 0 to 20 mA or 4 to 20 mA | |
| | External output allowable load resistance | 2 kΩ min. | 350 Ω max. | 2 kΩ min. | 350 Ω max. | |
| | External output impedance | 0.5 Ω max. | --- | 0.5 Ω max. | --- | |
| | Resolution | 1/6000 (full scale) | | 1/12000 (full scale) | | |
| | Overall accuracy | 25°C | 0.4% full scale | | 0.3% full scale | |
| | | 0 to 55°C | 0.8% full scale | | 0.7% full scale | |
| D/A conversion data | 16-bit binary (4-digit hexadecimal) Full scale for -10 to 10 V: F448 to 0BB8 Hex Full scale for other ranges: 0000 to 1770 Hex | | 16-bit binary (4-digit hexadecimal) Full scale for -10 to 10 V: E890 to 1770 Hex Full scale for other ranges: 0000 to 2EE0 Hex | | | |
| Conversion time | CP1W-DA021: 2 ms/point (4 ms/all points) CP1W-DA041: 2 ms/point (8 ms/all points) | | 1 ms/point (4 ms/all points) | | | |
| Isolation method | Photocoupler isolation between analog I/O terminals and internal circuits. No isolation between analog I/O signals. | | | | | |
| Current consumption | CP1W-DA021: 5 VDC: 40 mA max.; 24 VDC: 95 mA max. CP1W-DA041: 5 VDC: 80 mA max.; 24 VDC: 124 mA max. | | 5 VDC: 70 mA max.; 24 VDC: 160 mA max. | | | |

●Analog I/O Units

| Model | | CP1W-MAD42/CP1W-MAD44 | | CP1W-MAD11 | | |
|---------------------------------|--|--|--|--|--------------------------|-----------------|
| Item | | Voltage I/O | Current I/O | Voltage I/O | Current I/O | |
| Analog Input Section | Number of inputs | 4 inputs (4 words allocated) | | 2 inputs (2 words allocated) | | |
| | Input signal range | 0 to 5 VDC, 1 to 5 VDC, 0 to 10 VDC, or -10 to 10 VDC | 0 to 20 mA or 4 to 20 mA | 0 to 5 VDC, 1 to 5 VDC, 0 to 10 VDC, or -10 to 10 VDC | 0 to 20 mA or 4 to 20 mA | |
| | Max. rated input | ±15 V | ±30 mA | ±15 V | ±30 mA | |
| | External input impedance | 1 MΩ min. | Approx. 250 Ω | 1 MΩ min. | Approx. 250 Ω | |
| | Resolution | 1/12000 (full scale) | | 1/6000 (full scale) | | |
| | Overall accuracy | 25°C | 0.2% full scale | 0.3% full scale | 0.3% full scale | 0.4% full scale |
| | | 0 to 55°C | 0.5% full scale | 0.7% full scale | 0.6% full scale | 0.8% full scale |
| | A/D conversion data | 16-bit binary (4-digit hexadecimal) Full scale for -10 to 10 V: E890 to 1770 hex Full scale for other ranges: 0000 to 2EE0 hex | | 16-bit binary (4-digit hexadecimal) Full scale for -10 to 10 V: F448 to 0BB8 hex Full scale for other ranges: 0000 to 1770 hex | | |
| | Averaging function | Supported | | Supported (Settable for individual inputs via DIP switch) | | |
| Open-circuit detection function | Supported | | | | | |
| Analog Output Section | Number of outputs | CP1W-MAD42: 2 outputs (2 words allocated) CP1W-MAD44: 4 outputs (4 words allocated) | | 1 output (1 word allocated) | | |
| | Output signal range | 1 to 5 VDC, 0 to 10 VDC, or -10 to 10 VDC | 0 to 20 mA or 4 to 20 mA | 1 to 5 VDC, 0 to 10 VDC, or -10 to 10 VDC, | 0 to 20 mA or 4 to 20 mA | |
| | Allowable external output load resistance | 2 kΩ min. | 350 Ω max. | 1 kΩ min. | 600 Ω max. | |
| | External output impedance | 0.5 Ω max. | --- | 0.5 Ω max. | --- | |
| | Resolution | 1/12000 (full scale) | | 1/6000 (full scale) | | |
| | Overall accuracy | 25°C | 0.3% full scale | | 0.4% full scale | |
| | | 0 to 55°C | 0.7% full scale | | 0.8% full scale | |
| Set data (D/A conversion) | 16-bit binary (4-digit hexadecimal) Full scale for -10 to 10 V: E890 to 1770 hex Full scale for other ranges: 0000 to 2EE0 hex | | 16-bit binary (4-digit hexadecimal) Full scale for -10 to 10 V: F448 to 0BB8 hex Full scale for other ranges: 0000 to 1770 hex | | | |
| Conversion time | CP1W-MAD42: 1 ms/point (6 ms/all points) CP1W-MAD44: 1 ms/point (8 ms/all points) | | 2 ms/point (6 ms/all points) | | | |
| Isolation method | Photocoupler isolation between analog I/O terminals and internal circuits. No isolation between analog I/O signals. | | | | | |
| Current consumption | CP1W-MAD42: 5 VDC: 120 mA max., 24 VDC: 120 mA max. CP1W-MAD44: 5 VDC: 120 mA max., 24 VDC: 170 mA max. | | 5 VDC: 83 mA max., 24 VDC: 110 mA max. | | | |

●Temperature Sensors Units

| Item | CP1W-TS001 | CP1W-TS002 | CP1W-TS101 | CP1W-TS102 |
|----------------------------|--|------------|---|------------|
| Temperature sensors | Thermocouples | | Platinum resistance thermometer | |
| | Switchable between K and J, but same type must be used for all inputs. | | Switchable between Pt100 and JPt100, but same type must be used for all inputs. | |
| Number of inputs | 2 | 4 | 2 | 4 |
| Allocated input words | 2 | 4 | 2 | 4 |
| Accuracy | (The larger of ±0.5% of converted value or ±2°C) ±1 digit max. * | | (The larger of ±0.5% of converted value or ±1°C) ±1 digit max. | |
| Conversion time | 250 ms for 2 or 4 input points | | | |
| Converted temperature data | 16-bit binary data (4-digit hexadecimal) | | | |
| Isolation | Photocouplers between all temperature input signals | | | |
| Current consumption | 5 VDC: 40 mA max., 24 VDC: 59 mA max. | | 5 VDC: 54 mA max., 24 VDC: 73 mA max. | |

* Accuracy for a K-type sensor at -100°C or less is ±4°C ±1 digit max.

The rotary switch is used to set the temperature range.

| Setting | CP1W-TS001/TS002 | | | CP1W-TS101/TS102 | | |
|---------|------------------|----------------|---------------|------------------|-----------------|-------------------|
| | Input type | Range (°C) | Range (°F) | Input type | Range (°C) | Range (°F) |
| 0 | K | -200 to 1,300 | -300 to 2,300 | Pt100 | -200.0 to 650.0 | -300.0 to 1,200.0 |
| | | 0.0 to 500.0 | 0.0 to 900.0 | JPt100 | -200.0 to 650.0 | -300.0 to 1,200.0 |
| 2 | J | -100 to 850 | -100 to 1,500 | --- | Cannot be set. | |
| | | 0.0 to 400.0 | 0.0 to 750.0 | --- | | |
| 4 to F | --- | Cannot be set. | | --- | | |



●Main Specifications

| Item | | CP1W-TS003 |
|---------------------------------|-----------------------|--|
| Temperature sensors | | Thermocouples or analog input Switchable between K and J, but same type must be used for all inputs. |
| Number of inputs | | Thermocouples inputs :4 , Analog inputs :2 Two analog inputs can be shared with thermocouples inputs. |
| Accuracy at 25°C | Thermocouple inputs | (The larger of ±0.5% of converted value or ±2°C) ±1 digit max. *1 |
| | Analog voltage inputs | 0.5% full scale |
| | Analog inputs | 0.6% full scale |
| Accuracy at 0 to 55°C | Thermocouple inputs | (The larger of ±1% of converted value or ±4°C) ±1 digit max. *2 |
| | Analog voltage inputs | 1.0 % full scale |
| | Analog inputs | 1.2 % full scale |
| Input signal range | Thermocouple inputs | K: -200.0 to 1300.0°C or .300.0 to 2300.0°F J: -100.0 to 850.0°C or .100.0 to 1500.0°F |
| | Analog voltage inputs | 0 to 10V/1 to 5V |
| | Analog inputs | 4 to 20mA |
| Resolution | Thermocouple inputs | 0.1°C or 0.1°F |
| | Analog inputs | 1/12000 (full scale) |
| Max. rated input | Analog voltage inputs | ±15V |
| | Analog inputs | ±30mA |
| External input impedance | Analog voltage inputs | 1MΩ min. |
| | Analog inputs | Approx. 250Ω |
| Open-circuit detection function | | Supported |
| Averaging function | | Unsupported |
| Conversion time | | 250 ms for 4 input points |
| Converted temperature data | | 16-bit binary data (4-digit hexadecimal) |
| Converted AD data | | 16-bit binary data (4-digit hexadecimal) |
| Isolation | | Photocouplers between any two input signals |
| Current consumption | | 5 VDC: 70 mA max., 24 VDC: 30 mA max. |

* 1 Accuracy for a K-type sensor at -100°C or less is ±4°C ±1 digit max.

* 2 Accuracy for a K-type sensor at -100°C or less is ±10°C ±1 digit max.

DIP Switch Settings

The DIP switch is used to set the input type (temperature or analog input), the input thermocouple type (K or J) and the temperature unit (°C or °F).

Note: Set the temperature range according to the type of temperature sensor connected to the Unit. Temperature data will not be converted correctly if the temperature range does not match the sensor.

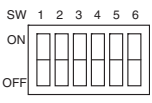
| SW | | Setting | |
|---|---|---|--|
|  | 1 | Thermocouple type of temperature sensor | ON: J OFF: K |
| | 2 | Temperature unit | ON: °F OFF: °C |
| | 3 | NC | |
| | 4 | Input type selection for the third input (Input 2) | ON: Analog input OFF: Thermocouple |
| | 5 | Input type selection for the fourth input (Input 3) | ON: Analog input OFF: Thermocouple |
| | 6 | Analog input signal range | ON: 1 to 5V/4 to 20mA OFF: 0 to 10V |

| Temperature input | | |
|-------------------|------------------|----------------|
| Input type | Range (°C) | Range (°F) |
| K | -200.0 to 1300.0 | -300 to 2300 |
| J | -100.0 to 850.0 | -100.0 to 1500 |

●Main Specifications

| Item | | CP1W-TS004 |
|----------------------------|-----------|---|
| Temperature sensors | | Thermocouples Switchable between K and J, but same type must be used for all inputs. |
| Number of inputs | | 12 (2 input words and 1 output word allocated) |
| Accuracy | 25°C | (The larger of ±0.5% of converted value or ±2°C) ±1 digit max. *1 |
| | 0 to 55°C | (The larger of ±1% of converted value or ±4°C) ±1 digit max. *2 |
| Conversion time | | 500 ms for 12 input points |
| Converted temperature data | | 16-bit binary data (4-digit hexadecimal) 2-decimal-place mode is not supported |
| Isolation | | Photocouplers between any two input signals |
| Current consumption | | 5 VDC: 80 mA max., 24 VDC: 50 mA max. |

* 1 Accuracy for a K-type sensor at -100°C or less is ±4°C ±1 digit max.

* 2 Accuracy for a K-type sensor at -100°C or less is ±10°C ±1 digit max.

DIP Switch Settings

The DIP switch is used to set the temperature unit and to set the temperature input range.

Note: Set the temperature range according to the type of temperature sensor connected to the Unit. Temperature data will not be converted correctly if the temperature range does not match the sensor.

| SW | | Setting | | |
|---|---|------------------|-----|----|
|  | 1 | Input type | ON | J |
| | | | OFF | K |
| | 2 | Temperature unit | ON | °F |
| | | | OFF | °C |

| Temperature input | | |
|-------------------|------------------|----------------|
| Input type | Range (°C) | Range (°F) |
| K | -200.0 to 1300.0 | -300 to 2300 |
| J | -100.0 to 850.0 | -100.0 to 1500 |

●CompoBus/S I/O Link Unit

| Model number | CP1W-SRT21 |
|--|--|
| Master/slave | CompoBus/S Slave |
| Number of I/O points | 8 input points, 8 output points |
| Number of words allocated in CPU Unit I/O memory | 1 input word, 1 output word |
| Node number setting | Set using the DIP switch (Set before turning on the CPU Unit's power supply.) |

Analog Option Board

An analog option board can be added to the CP1E-N/NA□□.

- Note:** 1. Can be used for the CP1E-N/NA□□ version 1.2 or later.
 2. Analog boards can not be used for E□□-type and N□□S(1)-type.

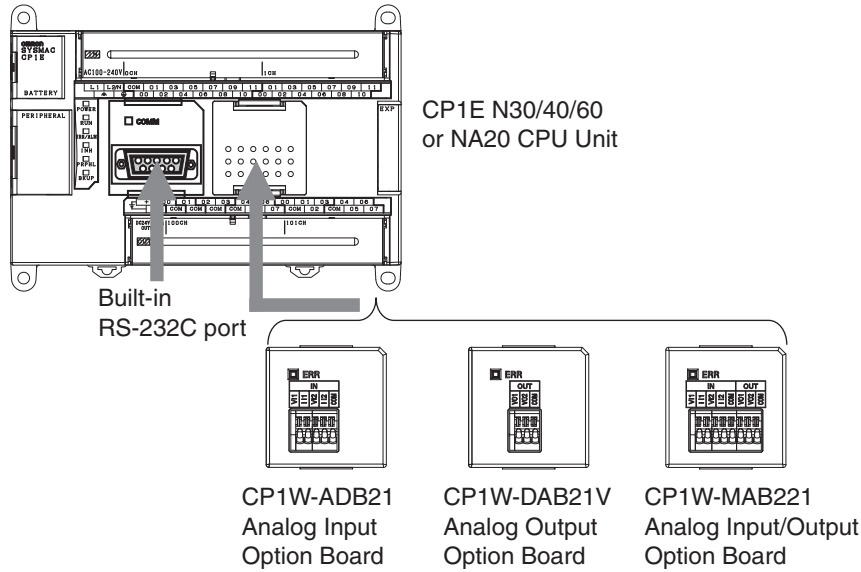

Specifications of Analog Option Board

●CP1W-ADB21

| Item | Specifications | |
|--------------------------|---------------------|---------------------|
| | Voltage Input | Current Input |
| Input signal range | 0 to 10 VDC | 0 to 20 mA |
| Max. rated input | 0 to 15 VDC | 0 to 30 mA |
| External input impedance | 200 kΩ min. | Approx. 250 Ω |
| Resolution | 1/4000 (full scale) | 1/2000 (full scale) |
| Overall accuracy | 25°C | 0.5% full scale |
| | 0 to 55°C | 1.0% full scale |
| A/D conversion data | 0000 to 0FA0 Hex | 0000 to 07D0 Hex |
| Averaging function | None | |
| Isolation method | not isolated | |
| Current consumption | 5 VDC: 20 mA max. | |

●CP1W-DAB21V

| Item | Specifications | |
|---|---------------------|-----------------|
| | Voltage Input | Current Input |
| Input signal range | 0 to 10 VDC | --- |
| External output allowable load resistance | 2 kΩ min. | --- |
| External output impedance | 0.5 Ω max. | --- |
| Resolution | 1/4000 (full scale) | --- |
| Overall accuracy | 25°C | 0.5% full scale |
| | 0 to 55°C | 1.0% full scale |
| Set data (D/A conversion) | 0000 to 0FA0 Hex | --- |
| Isolation method | not isolated | |
| Current consumption | 5 VDC: 60 mA max. | |

●CP1W-MAB221

| Item | Specifications | | |
|---------------------------|---|---------------------|-----------------|
| | Voltage Input | Current Input | |
| Analog Input Section | Input signal range | 0 to 10 VDC | |
| | Max. rated input | 0 to 15 VDC | |
| | External input impedance | 200 kΩ min. | |
| | Resolution | 1/4000 (full scale) | |
| | Overall accuracy | 25°C | 0.5% full scale |
| | | 0 to 55°C | 1.0% full scale |
| | A/D conversion data | 0000 to 0FA0 Hex | |
| Averaging function | None | | |
| Analog Output Section | Output signal range | 0 to 10 VDC | |
| | External output allowable load resistance | 2 kΩ min. | |
| | External output impedance | 0.5 Ω max. | |
| | Resolution | 1/4000 (full scale) | |
| | Overall accuracy | 25°C | 0.5% full scale |
| | | 0 to 55°C | 1.0% full scale |
| Set data (D/A conversion) | 0000 to 0FA0 Hex | | |
| Isolation method | not isolated | | |
| Current consumption | 5 VDC: 80 mA max. | | |

Analog Option Board Refresh Time

| Analog Option Board | Cycle time (ms) | | |
|---------------------|-----------------|---------|----------|
| | 1 ms | 10 ms | 20 ms |
| CP1W-ADB21 | 40 ±30% | 50 ±30% | 80 ±30% |
| CP1W-DAB21V | 30 ±40% | 40 ±50% | 70 ±40% |
| CP1W-MAB221(AD) | 60 ±40% | 80 ±60% | 100 ±50% |
| CP1W-MAB221(DA) | 40 ±80% | 60 ±60% | 90 ±50% |

External Interfaces

The CP1E CPU Units provide the following external interfaces.

E14/20S CPU Units

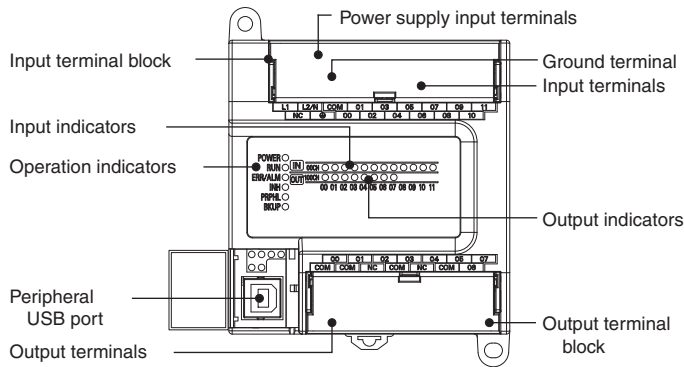

E30/40/60S CPU Units

E□□S-type

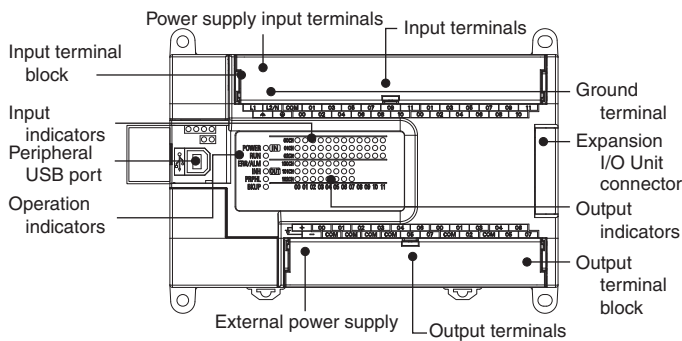

N30/40/60S(1) CPU Units

N□□S(1)-type

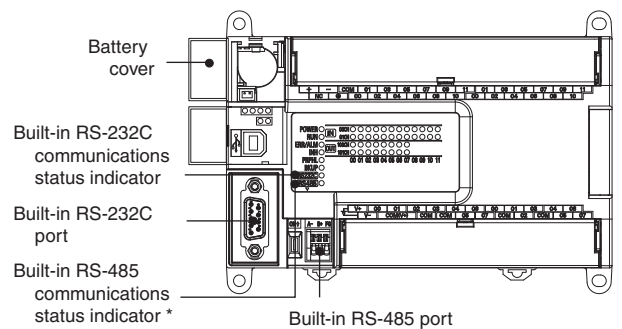

* N□□S1-type only.

E10/14/20 CPU Units

E□□-type

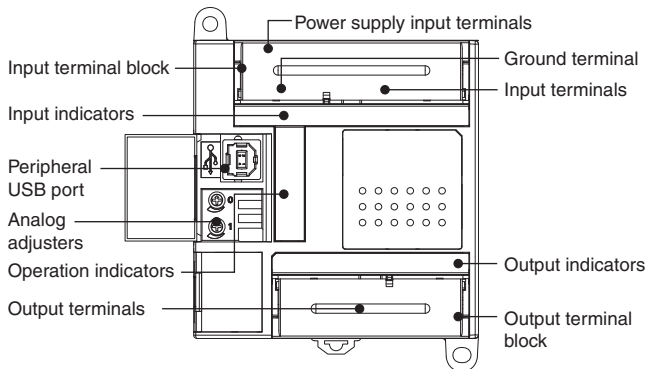

N14/20 CPU Units

N□□-type

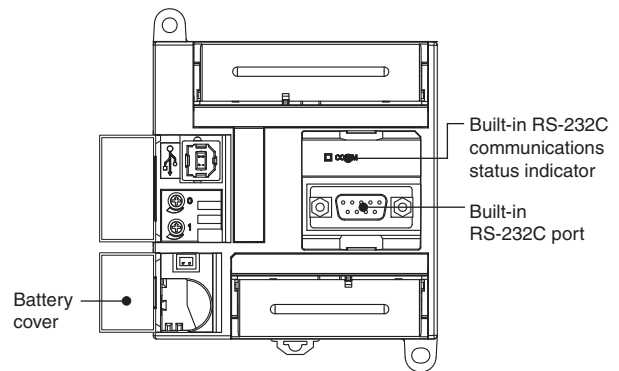

Note: Terminal Block (Fixed)

E30/40 CPU Units

E□□-type

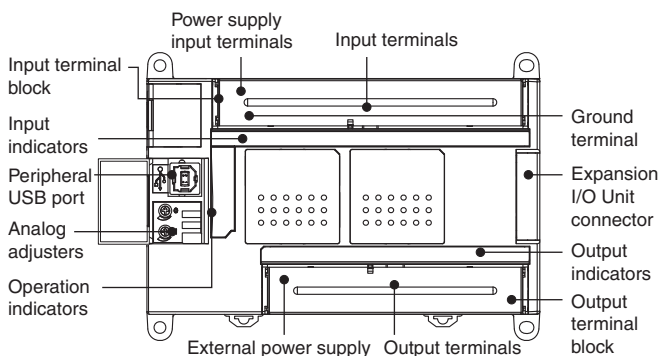

Note: Terminal Block (Fixed)

N30/40/60 or NA20 CPU Units

N□□-type/NA-type

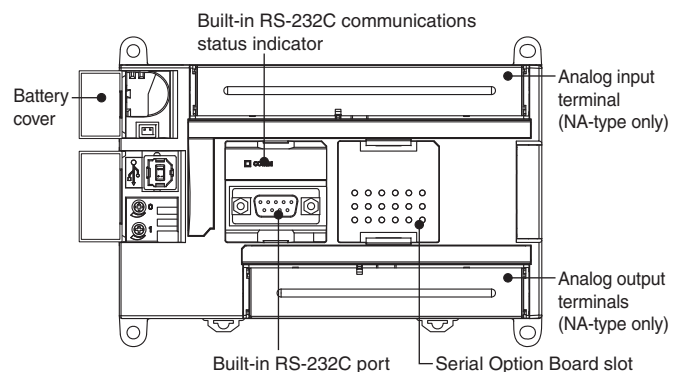

CP1E-E□□(S)D□-□ CP1E-N□□(S□)D□-□/NA20D□-□

Serial Communications Port for N/NA□□(S□)-type CPU Units

The Serial Communication Port can be used for a CP1E N/NA□□(S□)-type CPU Unit.

N30/40/60S1 CPU Units

Built-in RS-232C, RS-485 ports.

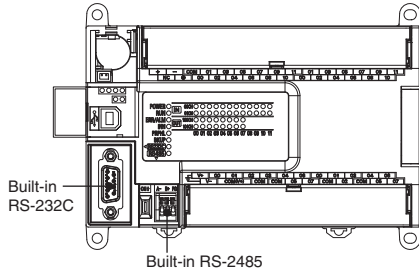

N30/40/60S CPU Units

Built-in RS-232C port.

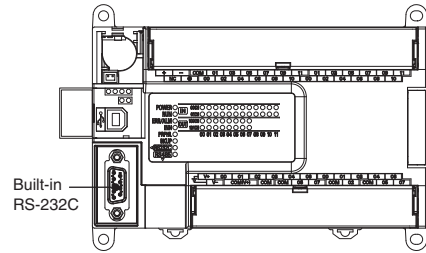

N30/40/60 or NA20 CPU Units

One built-in RS-232C port and one Option Board can be used.

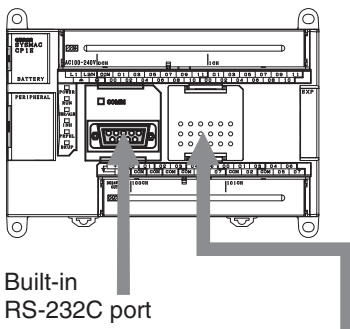

Optional Serial Communication Board

| Model number | Port | Maximum transmission distance | Connection method |
|--------------|-------------------------------------|-------------------------------|---------------------------------|
| CP1W-CIF01 | One RS-232C port | 15 m | Connector (D-sub, 9 pin female) |
| CP1W-CIF11 | One RS-422A/485 port (not isolated) | 50 m | Terminal block (using ferrules) |
| CP1W-CIF12 | One RS-422A/485 port (isolated) | 500 m | Terminal block (using ferrules) |
| CP1W-CIF41 | One Ethernet port | 100 m | Connector (RJ45, 8 pin modular) |

Note: The Optional Serial Communication Board cannot be used for CP1E N/NA□□S(1)-type CPU Units and E□□-type CPU Units.

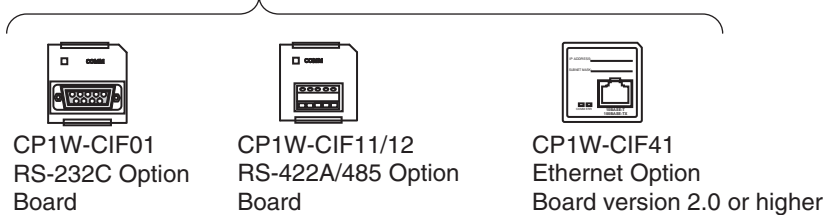

N14/20 CPU Units

Built-in RS-232C ports.

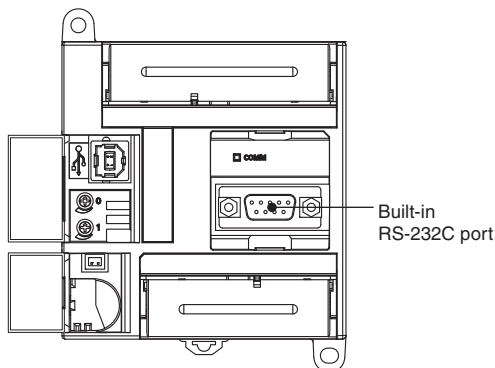

Note: Option Boards cannot be used for CP1E N14/20 CPU Units.

Built-in RS-232C Port and CP1W-CIF01 RS-232C Option Board

●RS-232C Connector

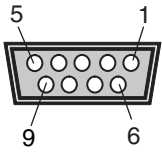

Front
Communications Status Indicator

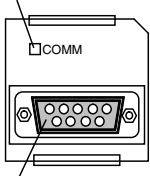

RS-232 Connector

Back

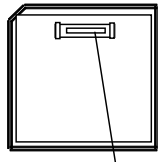

CPU Unit Connector

| Pin | Abbreviation for signal name | | Signal name | Signal direction |
|----------------|---|------------------------------------|---------------------|------------------|
| | N□□-type built-in RS-232C port / CP1W-CIF01 | N□□S(1)-type Built-in RS-232C port | | |
| 1 | FG | | Frame ground | -- |
| 2 | SD (TXD) | | Send data | Output |
| 3 | RD (RXD) | | Receive data | Input |
| 4 | RS (RTS) | | Request to send | Output |
| 5 | CS (CTS) | | Clear to send | Input |
| 6 | 5 V | | Power supply | -- |
| 7 | DR (DSR) | NC * | Data set ready | Input |
| 8 | ER (DTR) | NC * | Data terminal ready | Output |
| 9 | SG (0 V) | | Signal ground | -- |
| Connector hood | FG | | Frame Ground | -- |

* Built-in RS-232C port of N□□S(1)-type does not support DR/ER.
CJ1W-CIF11 cannot be used for the built-in RS-232C port of N□□S(1)-type.

Built-in RS-232C Port (2-wire sensors) (N□□S1-type only)

●RS-485 Terminal Block

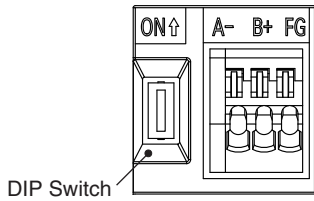

●DIP Switch for Terminating Resistance Settings

| Settings | | |
|----------|----------------|----------------------------------|
| ON | ON (both ends) | Terminating resistance selection |
| OFF | OFF | Resistance: Approx. 220Ω |

CP1W-CIF11/CIF12 RS-422A/485 Option Board

Front
Communications Status Indicator

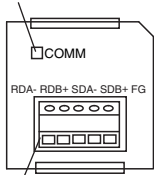

RS-422A/485 Connector

Back

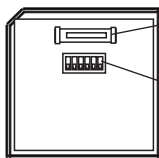

CPU Unit Connector
DIP Switch for Operation Settings

●RS-422A/485 Terminal Block

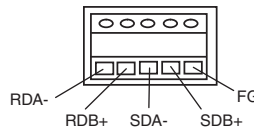

Tighten the terminal block screws to a torque of 0.28 N·m.

CP1W-CIF41 Ethernet Option Board version 2.0 or higher

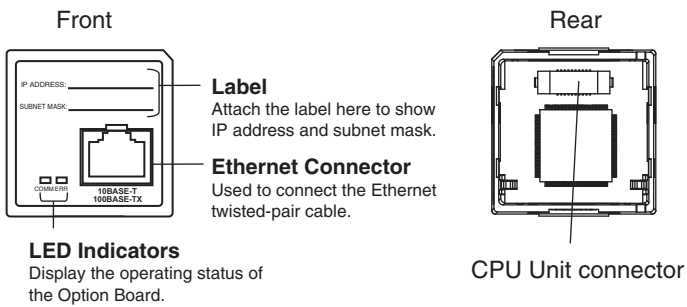

● Specifications

| | | | |
|--------------------------------------|---|--|--|
| Type | 100/10Base-TX (Auto-MDIX) | | |
| Support Software | CX-Programmer version 9.12 or higher | | |
| Transfer | Media access method | CSMA/CD | |
| | Modulation method | Baseband | |
| | Transmission paths | Star form | |
| | Baud rate | 100 Mbit/s (100Base-TX) | 10 Mbit/s (10Base-TX) |
| | | <ul style="list-style-type: none"> • Half/full auto-negotiation for each port • Link speed auto-sensing for each port | |
| | Transmission media | <ul style="list-style-type: none"> • Unshielded twisted-pair (UDP) cable Categories: 5, 5e • Shielded twisted-pair (STP) cable Categories: 100Ω at 5, 5e | <ul style="list-style-type: none"> • Unshielded twisted-pair (UDP) cable Categories: 3, 4, 5, 5e • Shielded twisted-pair (STP) cable Categories: 100Ω at 3, 4, 5, 5e |
| Transmission Distance | | 100 m (distance between hub and node) | |
| Number of cascade connections | No restrictions if switching hubs are used. | | |

● FINS Communications Service Specifications

| | | |
|------------------------------|--|-----------------------------------|
| Number of nodes | 254 | |
| Message Length | 552 bytes max. | |
| Date Length | 540 bytes max. (except for FINS header 10 byte and Command header 2 byte.) | |
| Number of buffer | 8k byte | |
| Protocol name | FINS/UDP method | FINS/TCP method |
| Protocol used | UDP/IP | TCP/IP |
| | The selection of UDP/IP or TCP/IP is made from the FINS/TCP Tab by the Web browser function. | |
| Server/Client | Only server (Cannot be used as a client) | |
| Number of connections | --- | 2 |
| Port number | 9600 (default) Can be changed. | 9600 (default) Can be changed. |
| | Protection | No |

Connecting to Support Software

Operating Environment and System Configuration

The following system is required to operate the CX-Programmer. Make sure your system provides the following conditions and has the necessary components.

| Item | Description |
|-----------------------------|--|
| Supported computer | IBM PC/AT or equivalent |
| CD-ROM or DVD-ROM drive | One or more |
| Supported Operating Systems | Windows 2000 (Service Pack 4 or higher), XP, Vista, or 7 (except 64-bit edition) |
| CPU | Pentium II 333 MHz or faster |
| RAM | 256 MB min. 512 MB or more recommended |
| Available hard disk space | 600 MB min. |
| Display | 800 x 600 SVGA min. |
| PLC and connection port | USB port, RS-232C port, RS-422A/485 port or Ethernet port |

Connecting Methods

Using commercially available USB cable, connect the CX-Programmer to the peripheral USB port on the CPU Unit. Host link connection can be made with RS-232C port to connect the Programming Device (CX-Programmer).

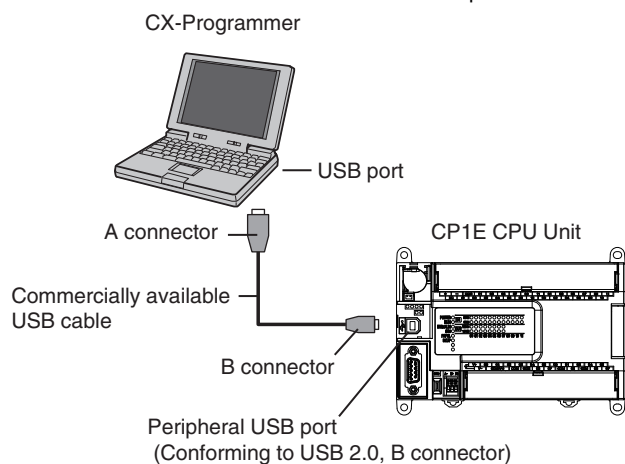

Connecting Cable

Use the following cable to connect the CP1E CPU Unit to the computer running the Support Software.

USB port

| Port at Unit | Port at computer | Network type (communications mode) | Model numbers | Length |
|---|------------------|------------------------------------|---|---------------|
| Peripheral USB port (Conforming to USB 2.0, B connector) | USB port | USB 2.0 (or 1.1) | Commercially available USB cable (A connector - B connector) | Less than 5 m |

RS-232C Port for N/NA□□(S□)-type CPU Units

| Port at Unit | Port at computer | Communications mode | Connecting Cable | | |
|---|------------------|-----------------------|------------------|--------|-----------------------------|
| | | | Model | Length | Remarks |
| RS-232C Port or CP1W-CIF01 (Add this to the option board slot.) | RS-232C port * | Host Link (SYSWAY) | XW2Z-200S-CV | 2m | With anti-static connectors |
| | | | XW2Z-500S-CV | 5m | With anti-static connectors |
| | | | XW2Z-200S-V | 2m | --- |
| | | | XW2Z-500S-V | 5m | --- |

Note: Connectable with CX-Programmer Ver.9.1 or higher only.

* Use the USB-Serial Conversion Cable CS1W-CIF31 together to connect a PLC to a personal computer's USB port.

Programming Instructions

Sequence Input Instructions

| Instruction | Mnemonic |
|---------------|----------|
| LOAD | LD |
| LOAD NOT | LD NOT |
| AND | AND |
| AND NOT | AND NOT |
| OR | OR |
| OR NOT | OR NOT |
| AND LOAD | AND LD |
| OR LOAD | OR LD |
| NOT | NOT |
| CONDITION ON | UP |
| CONDITION OFF | DOWN |

Sequence Output Instructions

| Instruction | Mnemonic |
|--------------------|----------|
| OUTPUT | OUT |
| OUTPUT NOT | OUT NOT |
| KEEP | KEEP |
| DIFFERENTIATE UP | DIFU |
| DIFFERENTIATE DOWN | DIFD |
| SET | SET |
| RESET | RSET |
| MULTIPLE BIT SET | SETA |
| MULTIPLE BIT RESET | RSTA |
| SINGLE BIT SET | SETB |
| SINGLE BIT RESET | RSTB |

Sequence Output Instructions

| Instruction | Mnemonic |
|---|----------|
| END | END |
| NO OPERATION | NOP |
| INTERLOCK | IL |
| INTERLOCK CLEAR | ILC |
| MULTI-INTERLOCK DIFFERENTIATION HOLD | MILH |
| MULTI-INTERLOCK DIFFERENTIATION RELEASE | MILR |
| MULTI-INTERLOCK CLEAR | MILC |
| JUMP | JMP |
| JUMP END | JME |
| CONDITIONAL JUMP | CJP |
| FOR LOOP | FOR |
| BREAK LOOP | BREAK |
| NEXT LOOP | NEXT |

Timer and Counter Instructions

| Instruction | Mnemonic |
|---------------------|----------|
| TIMER | TIM |
| | TIMX |
| COUNTER | CNT |
| | CNTX |
| HIGH-SPEED TIMER | TIMH |
| | TIMHX |
| ONE-MS TIMER | TMHH |
| | TMHHX |
| ACCUMULATIVE TIMER | TTIM |
| | TTIMX |
| LONG TIMER | TIML |
| | TIMLX |
| REVERSIBLE COUNTER | CNTR |
| | CNTRX |
| RESET TIMER/COUNTER | CNR |
| | CNRX |

Comparison Instructions

| Instruction | Mnemonic |
|--|-----------------|
| Input Comparison Instructions (unsigned) | LD,AND,OR+= |
| | LD,AND,OR+<> |
| | LD,AND,OR+< |
| | LD,AND,OR+<= |
| | LD,AND,OR+> |
| Input Comparison Instructions (double, unsigned) | LD,AND,OR+=+L |
| | LD,AND,OR+<>+L |
| | LD,AND,OR+<+L |
| | LD,AND,OR+<=+L |
| | LD,AND,OR+>+L |
| Input Comparison Instructions (signed) | LD,AND,OR+=+S |
| | LD,AND,OR+<>+S |
| | LD,AND,OR+<+S |
| | LD,AND,OR+<=+S |
| | LD,AND,OR+>+S |
| Input Comparison Instructions (double, signed) | LD,AND,OR+=+SL |
| | LD,AND,OR+<>+SL |
| | LD,AND,OR+<+SL |
| | LD,AND,OR+<=+SL |
| | LD,AND,OR+>+SL |
| Time Comparison Instructions | =DT |
| | <>DT |
| | <DT |
| | <=DT |
| | >DT |
| >=DT | |
| COMPARE | CMP |
| DOUBLE COMPARE | CMPL |
| SIGNED BINARY COMPARE | CPS |
| DOUBLE SIGNED BINARY COMPARE | CPSL |
| TABLE COMPARE | TCMP |
| UNSIGNED BLOCK COMPARE | BCMP |
| AREA RANGE COMPARE | ZCP |
| DOUBLE AREA RANGE COMPARE | ZCPL |

Data Movement Instructions

| Instruction | Mnemonic |
|------------------------|----------|
| MOVE | MOV |
| DOUBLE MOVE | MOVL |
| MOVE NOT | MVN |
| MOVE BIT | MOVb |
| MOVE DIGIT | MOVD |
| MULTIPLE BIT TRANSFER | XFRb |
| BLOCK TRANSFER | XFER |
| BLOCK SET | BSET |
| DATA EXCHANGE | XCHG |
| SINGLE WORD DISTRIBUTE | DIST |
| DATA COLLECT | COLL |

Data Shift Instructions

| Instruction | Mnemonic |
|---------------------------|----------|
| SHIFT REGISTER | SFT |
| REVERSIBLE SHIFT REGISTER | SFTR |
| WORD SHIFT | WSFT |
| ARITHMETIC SHIFT LEFT | ASL |
| ARITHMETIC SHIFT RIGHT | ASR |
| ROTATE LEFT | ROL |
| ROTATE RIGHT | ROR |
| ONE DIGIT SHIFT LEFT | SLD |
| ONE DIGIT SHIFT RIGHT | SRD |
| SHIFT N-BITS LEFT | NASL |
| DOUBLE SHIFT N-BITS LEFT | NSLL |
| SHIFT N-BITS RIGHT | NASR |
| DOUBLE SHIFT N-BITS RIGHT | NSRL |

Increment/Decrement Instructions

| Instruction | Mnemonic |
|-------------------------|----------|
| INCREMENT BINARY | ++ |
| DOUBLE INCREMENT BINARY | ++L |
| DECREMENT BINARY | -- |
| DOUBLE DECREMENT BINARY | --L |
| INCREMENT BCD | ++B |
| DOUBLE INCREMENT BCD | ++BL |
| DECREMENT BCD | --B |
| DOUBLE DECREMENT BCD | --BL |

Symbol Math Instructions

| Instruction | Mnemonic |
|---|----------|
| SIGNED BINARY ADD WITHOUT CARRY | + |
| DOUBLE SIGNED BINARY ADD WITHOUT CARRY | +L |
| SIGNED BINARY ADD WITH CARRY | +C |
| DOUBLE SIGNED BINARY ADD WITH CARRY | +CL |
| BCD ADD WITHOUT CARRY | +B |
| DOUBLE BCD ADD WITHOUT CARRY | +BL |
| BCD ADD WITH CARRY | +BC |
| DOUBLE BCD ADD WITH CARRY | +BCL |
| SIGNED BINARY SUBTRACT WITHOUT CARRY | - |
| DOUBLE SIGNED BINARY SUBTRACT WITHOUT CARRY | -L |
| SIGNED BINARY SUBTRACT WITH CARRY | -C |
| DOUBLE SIGNED BINARY SUBTRACT WITH CARRY | -CL |
| BCD SUBTRACT WITHOUT CARRY | -B |
| DOUBLE BCD SUBTRACT WITHOUT CARRY | -BL |
| BCD SUBTRACT WITH CARRY | -BC |
| DOUBLE BCD SUBTRACT WITH CARRY | -BCL |
| SIGNED BINARY MULTIPLY | * |
| DOUBLE SIGNED BINARY MULTIPLY | *L |
| BCD MULTIPLY | *B |
| DOUBLE BCD MULTIPLY | *BL |
| SIGNED BINARY DIVIDE | / |
| DOUBLE SIGNED BINARY DIVIDE | /L |
| BCD DIVIDE | /B |
| DOUBLE BCD DIVIDE | /BL |

Conversion Instructions

| Instruction | Mnemonic |
|-----------------------------|----------|
| BCD-TO-BINARY | BIN |
| DOUBLE BCD-TO-DOUBLE BINARY | BINL |
| BINARY-TO-BCD | BCD |
| DOUBLE BINARY-TO-DOUBLE BCD | BCDL |
| 2'S COMPLEMENT | NEG |
| DATA DECODER | MLPX |
| DATA ENCODER | DMPX |
| ASCII CONVERT | ASC |
| ASCII TO HEX | HEX |

Logic Instructions

| Instruction | Mnemonic |
|---------------------|----------|
| LOGICAL AND | ANDW |
| DOUBLE LOGICAL AND | ANDL |
| LOGICAL OR | ORW |
| DOUBLE LOGICAL OR | ORWL |
| EXCLUSIVE OR | XORW |
| DOUBLE EXCLUSIVE OR | XORL |
| COMPLEMENT | COM |
| DOUBLE COMPLEMENT | COML |

Special Math Instructions

| Instruction | Mnemonic |
|--------------------|----------|
| ARITHMETIC PROCESS | APR |
| BIT COUNTER | BCNT |

Floating-point Math Instructions

| Instruction | Mnemonic |
|----------------------------|-----------------|
| FLOATING TO 16-BIT | FIX |
| FLOATING TO 32-BIT | FIXL |
| 16-BIT TO FLOATING | FLT |
| 32-BIT TO FLOATING | FLT L |
| FLOATING-POINT ADD | +F |
| FLOATING-POINT SUBTRACT | -F |
| FLOATING-POINT DIVIDE | /F |
| FLOATING-POINT MULTIPLY | *F |
| Floating Symbol Comparison | LD, AND, OR+=F |
| | LD, AND, OR+<>F |
| | LD, AND, OR+<F |
| | LD, AND, OR+<=F |
| | LD, AND, OR+>F |
| LD, AND, OR+>=F | |
| FLOATING- POINT TO ASCII | FSTR |
| ASCII TO FLOATING-POINT | FVAL |

Table Data Processing Instructions

| Instruction | Mnemonic |
|----------------|----------|
| SWAP BYTES | SWAP |
| FRAME CHECKSUM | FCS |

Data Control Instructions

| Instruction | Mnemonic |
|-----------------------------|----------|
| PID CONTROL WITH AUTOTUNING | PIDAT |
| TIME-PROPORTIONAL OUTPUT | TPO |
| SCALING | SCL |
| SCALING 2 | SCL2 |
| SCALING 3 | SCL3 |
| AVERAGE | AVG |

Subroutine Instructions

| Instruction | Mnemonic |
|-------------------|----------|
| SUBROUTINE CALL | SBS |
| SUBROUTINE ENTRY | SBN |
| SUBROUTINE RETURN | RET |

Interrupt Control Instructions

| Instruction | Mnemonic |
|--------------------|----------|
| SET INTERRUPT MASK | MSKS |
| CLEAR INTERRUPT | CLI |
| DISABLE INTERRUPTS | DI |
| ENABLE INTERRUPTS | EI |

High-speed Counter and Pulse Output Instructions

| Instruction | Mnemonic |
|---------------------------------|----------|
| MODE CONTROL | INI |
| HIGH-SPEED COUNTER PV READ | PRV |
| COMPARISON TABLE LOAD | CTBL |
| SPEED OUTPUT | SPED |
| SET PULSES | PULS |
| PULSE OUTPUT | PLS2 |
| ACCELERATION CONTROL | ACC |
| ORIGIN SEARCH | ORG |
| PULSE WITH VARIABLE DUTY FACTOR | PWM |

Step Instructions

| Instruction | Mnemonic |
|-------------|----------|
| STEP DEFINE | STEP |
| STEP START | SNXT |

I/O Unit Instructions

| Instruction | Mnemonic |
|--------------------------|----------|
| I/O REFRESH | IORF |
| 7-SEGMENT DECODER | SDEC |
| DIGITAL SWITCH INPUT | DSW |
| MATRIX INPUT | MTR |
| 7-SEGMENT DISPLAY OUTPUT | 7SEG |

Serial Communications Instructions

| Instruction | Mnemonic |
|-------------|----------|
| TRANSMIT | TXD |
| RECEIVE | RXD |

Clock Instructions

| Instruction | Mnemonic |
|-------------------|----------|
| CALENDAR ADD | CADD |
| CALENDAR SUBTRACT | CSUB |
| CLOCK ADJUSTMENT | DATE |

Failure Diagnosis Instructions

| Instruction | Mnemonic |
|----------------------|----------|
| FAILURE ALARM | FAL |
| SEVERE FAILURE ALARM | FALS |

Other Instructions

| Instruction | Mnemonic |
|---------------------------|----------|
| SET CARRY | STC |
| CLEAR CARRY | CLC |
| EXTEND MAXIMUM CYCLE TIME | WDT |

Dimensions

(Unit: mm)

CP1E CPU Unit

●CPU Units with 10 I/O Points

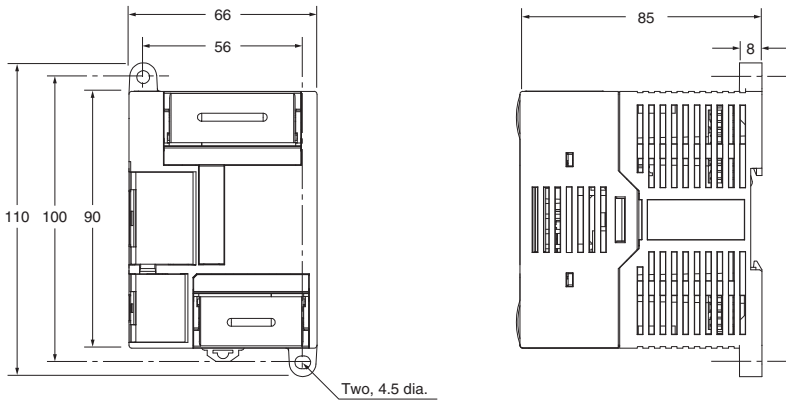

●CPU Units with 14 or 20 I/O Points

CP1E-□14/20D□□-□

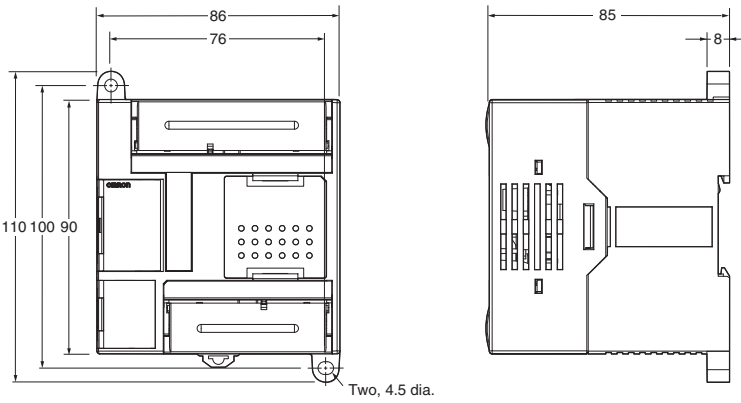

CP1E-□14/20SD□□-□

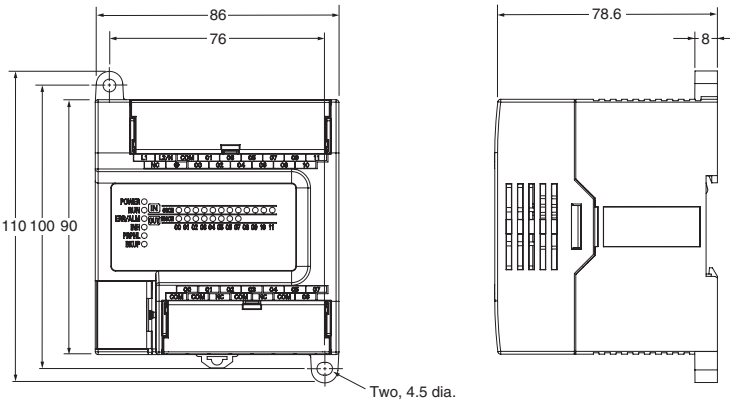

●CPU Units with 30 I/O Points

●CPU Units with 20 I/O Points and Built-in Analog

CP1E-□30D□□-□, CP1E-NA20D□-□

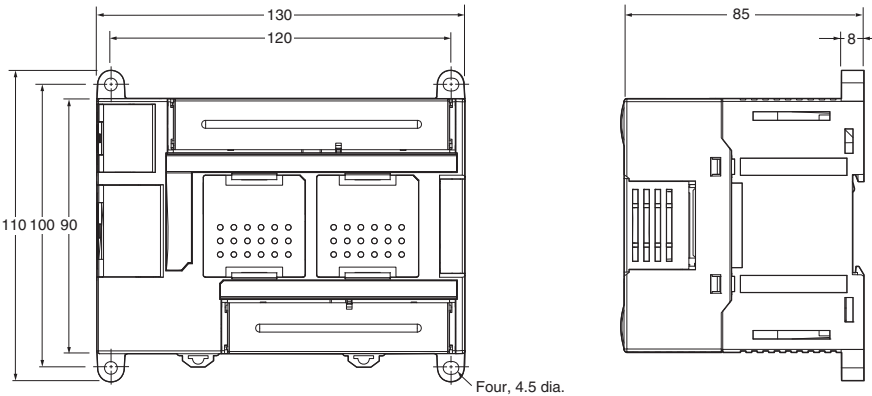

CP1E-E□□(S)D□-□ CP1E-N□□(S□)D□-□/NA20D□-□

CP1E-□30S(1)D□□-□

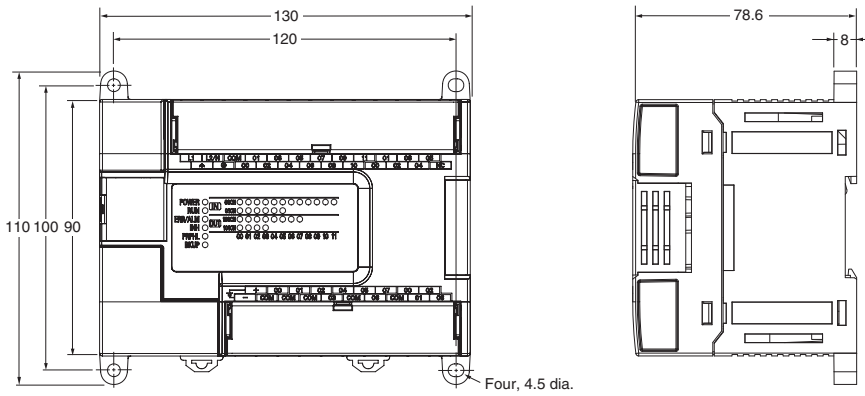

●CPU Units with 40 I/O Points

CP1E-□40D□□-□

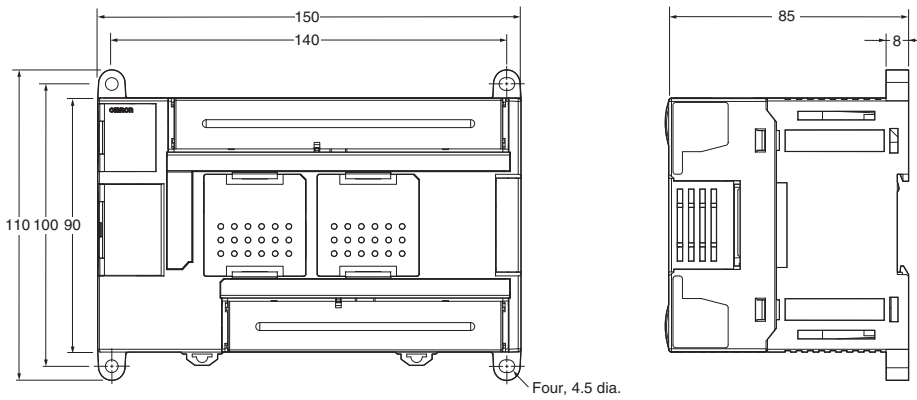

CP1E-□40S(1)D□□-□

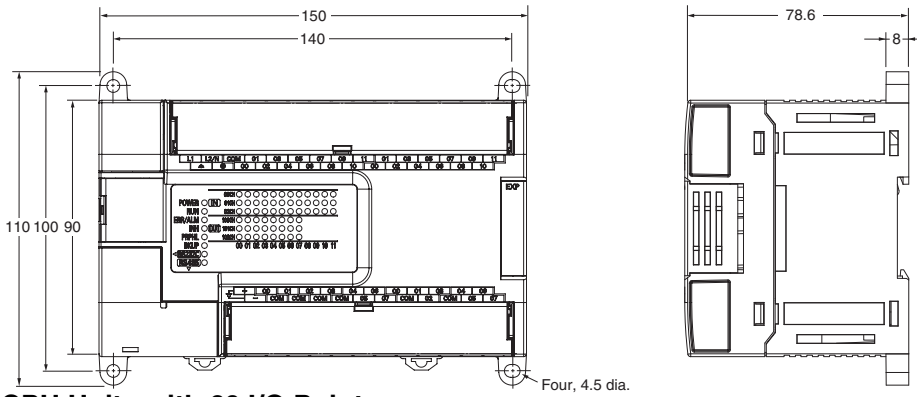

●CPU Units with 60 I/O Points

CP1E-N60D□□-□

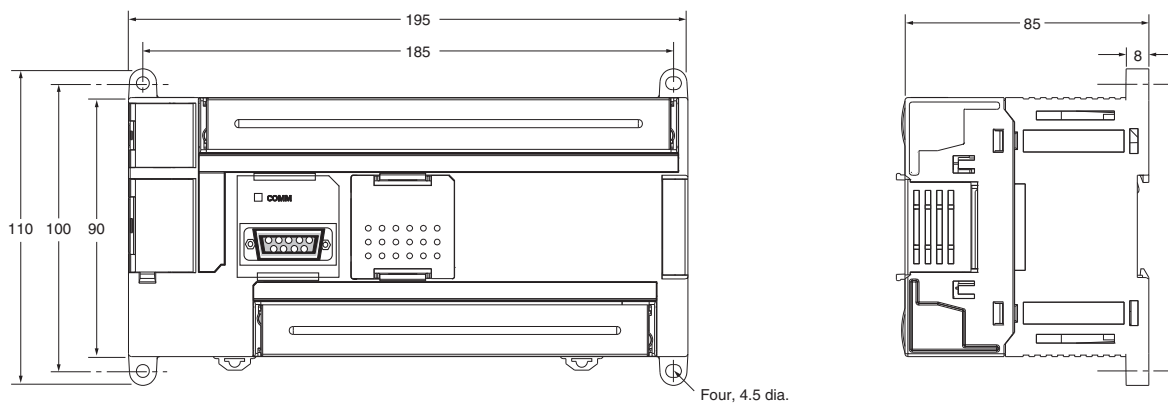

CP1E-□60S(1)D□□-□

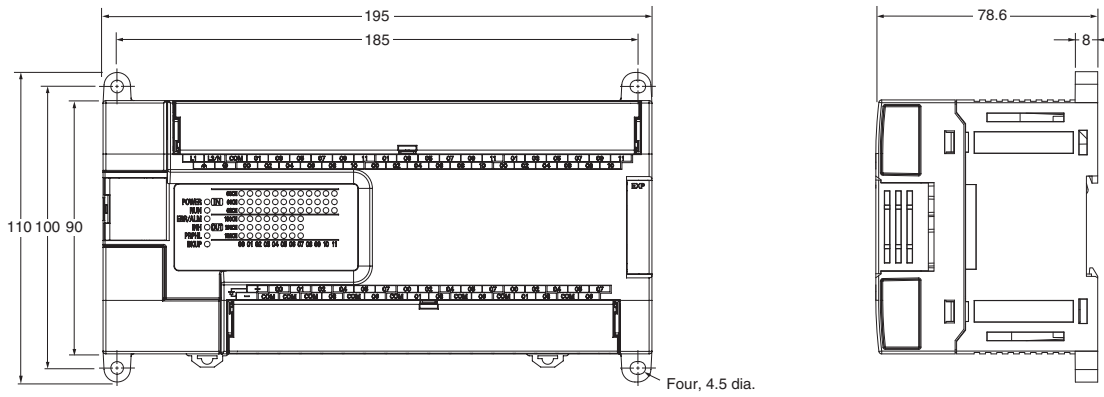

Expansion I/O Units and Expansion Units

●CP1W-8E□□/CP1W-SRT21

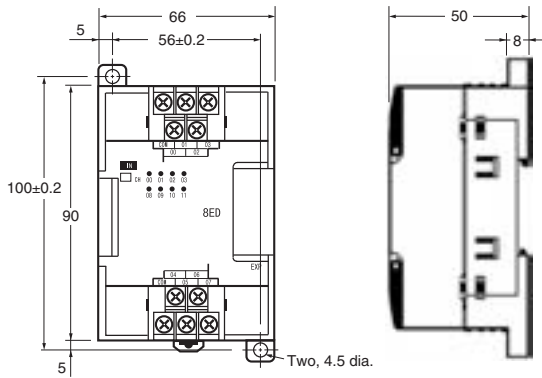

●CP1W-20ED□/CP1W-16E□□/CP1W-AD04□/CP1W-DA021/CP1W-DA04□/CP1W-MAD□□/
CP1W-TS□□1/□□2/□□3

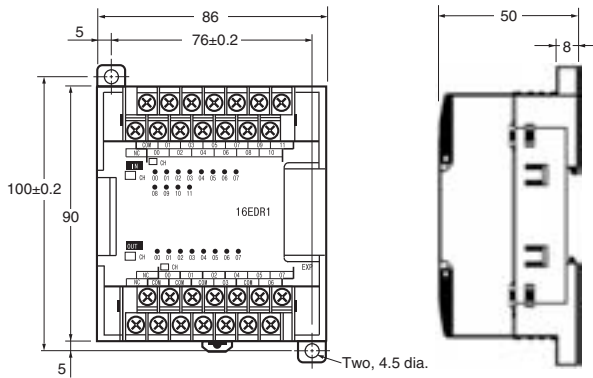

●CP1W-40ED□/CP1W-32E□□/CP1W-TS004

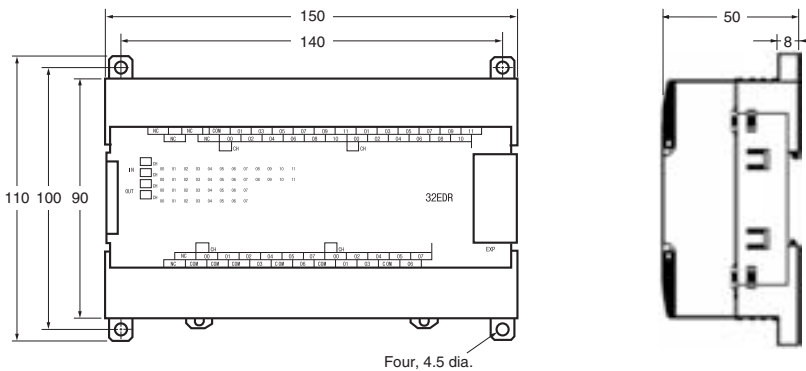

Related Manuals

| Manual name | Cat. No. | Model numbers | Application | Contents |
|--|----------|---|--|---|
| SYSMAC CP Series CP1E CPU Unit Hardware Manual | W479 | CP1E-E□□SD□-□ CP1E-N□□SD□-□ CP1E-E□□D□-□ CP1E-N□□D□-□ CP1E-NA□□D□-□ | To learn the hardware specifications of the CP1E PLCs | Describes the following information for CP1E PLCs. <ul style="list-style-type: none"> • Overview and features • Basic system configuration • Part names and functions • Installation and settings • Troubleshooting |
| | | | Use this manual together with the CP1E CPU Unit Software Manual (Cat. No. W480) and CP1E CPU Unit Instructions Reference Manual (Cat. No. W483). | |
| SYSMAC CP Series CP1E CPU Unit Software Manual | W480 | CP1E-E□□SD□-□ CP1E-N□□SD□-□ CP1E-E□□D□-□ CP1E-N□□D□-□ CP1E-NA□□D□-□ | To learn the software specifications of the CP1E | Describes the following information for CP1E PLCs. <ul style="list-style-type: none"> • CPU Unit operation • Internal memory • Programming • Settings • CPU Unit built-in functions • Interrupts • High-speed counter inputs • Pulse outputs • Serial communications • Analog I/O function • Other functions |
| | | | Use this manual together with the CP1E CPU Unit Hardware Manual (Cat. No. W479) and CP1E CPU Unit Instructions Reference Manual (Cat. No. W483). | |
| SYSMAC CP Series CP1E CPU Unit Instructions Reference Manual | W483 | CP1E-E□□SD□-□ CP1E-N□□SD□-□ CP1E-E□□D□-□ CP1E-N□□D□-□ CP1E-NA□□D□-□ | To learn programming instructions in detail | Describes each programming instruction in detail. When programming, use this manual together with the CP1E CPU Unit Hardware Manual (Cat. No. W479) and CP1E CPU Unit Software Manual (Cat. No. W480). |
| CS/CJ/CP/NSJ Series Communications Commands Reference Manual | W342 | CS1G/H-CPU□□H CS1G/H-CPU□□-V1 CS1D-CPU□□H CS1D-CPU□□S CS1W-SCU□□-V1 CS1W-SCB□□-V1 CJ1G/H-CPU□□H CJ1G-CPU□□P CJ1M-CPU□□ CJ1G-CPU□□ CJ1W-SCU□□-V1 | To learn communications commands for CS/CJ/CP/NSJ-series Controllers in detail | Describes 1) C-mode commands and 2) FINS commands in detail. Read this manual for details on C-mode and FINS commands addressed to CPU Units. |
| | | | Note: This manual describes commands addressed to CPU Units. It does not cover commands addressed to other Units or ports (e.g., serial communications ports on CPU Units, communications ports on Serial Communications Units/Boards, and other Communications Units). | |
| SYSMAC CP Series CP1L/CP1E CPU Unit Introduction Manual | W461 | CP1L-L10D□-□ CP1L-L14D□-□ CP1L-L20D□-□ CP1L-M30D□-□ CP1L-M40D□-□ CP1L-M60D□-□ CP1E-E□□D□-□ CP1E-N□□D□-□ CP1E-NA□□D□-□ | To learn the basic setup methods of the CP1L/CP1E PLCs | Describes the following information for CP1L/CP1E PLCs. <ul style="list-style-type: none"> • Basic configuration and component names • Mounting and wiring • Programming, data transfer, and debugging using the CX-Programmer • Application program examples |

Terms and Conditions Agreement

Read and understand this catalog.

Please read and understand this catalog before purchasing the products. Please consult your OMRON representative if you have any questions or comments.

Warranties.

- (a) Exclusive Warranty. Omron's exclusive warranty is that the Products will be free from defects in materials and workmanship for a period of twelve months from the date of sale by Omron (or such other period expressed in writing by Omron). Omron disclaims all other warranties, express or implied.
- (b) Limitations. OMRON MAKES NO WARRANTY OR REPRESENTATION, EXPRESS OR IMPLIED, ABOUT NON-INFRINGEMENT, MERCHANTABILITY OR FITNESS FOR A PARTICULAR PURPOSE OF THE PRODUCTS. BUYER ACKNOWLEDGES THAT IT ALONE HAS DETERMINED THAT THE PRODUCTS WILL SUITABLY MEET THE REQUIREMENTS OF THEIR INTENDED USE.

Omron further disclaims all warranties and responsibility of any type for claims or expenses based on infringement by the Products or otherwise of any intellectual property right. (c) Buyer Remedy. Omron's sole obligation hereunder shall be, at Omron's election, to (i) replace (in the form originally shipped with Buyer responsible for labor charges for removal or replacement thereof) the non-complying Product, (ii) repair the non-complying Product, or (iii) repay or credit Buyer an amount equal to the purchase price of the non-complying Product; provided that in no event shall Omron be responsible for warranty, repair, indemnity or any other claims or expenses regarding the Products unless Omron's analysis confirms that the Products were properly handled, stored, installed and maintained and not subject to contamination, abuse, misuse or inappropriate modification. Return of any Products by Buyer must be approved in writing by Omron before shipment. Omron Companies shall not be liable for the suitability or unsuitability or the results from the use of Products in combination with any electrical or electronic components, circuits, system assemblies or any other materials or substances or environments. Any advice, recommendations or information given orally or in writing, are not to be construed as an amendment or addition to the above warranty.

See <http://www.omron.com/global/> or contact your Omron representative for published information.

Limitation on Liability; Etc.

OMRON COMPANIES SHALL NOT BE LIABLE FOR SPECIAL, INDIRECT, INCIDENTAL, OR CONSEQUENTIAL DAMAGES, LOSS OF PROFITS OR PRODUCTION OR COMMERCIAL LOSS IN ANY WAY CONNECTED WITH THE PRODUCTS, WHETHER SUCH CLAIM IS BASED IN CONTRACT, WARRANTY, NEGLIGENCE OR STRICT LIABILITY.

Further, in no event shall liability of Omron Companies exceed the individual price of the Product on which liability is asserted.

Suitability of Use.

Omron Companies shall not be responsible for conformity with any standards, codes or regulations which apply to the combination of the Product in the Buyer's application or use of the Product. At Buyer's request, Omron will provide applicable third party certification documents identifying ratings and limitations of use which apply to the Product. This information by itself is not sufficient for a complete determination of the suitability of the Product in combination with the end product, machine, system, or other application or use. Buyer shall be solely responsible for determining appropriateness of the particular Product with respect to Buyer's application, product or system. Buyer shall take application responsibility in all cases.

NEVER USE THE PRODUCT FOR AN APPLICATION INVOLVING SERIOUS RISK TO LIFE OR PROPERTY OR IN LARGE QUANTITIES WITHOUT ENSURING THAT THE SYSTEM AS A WHOLE HAS BEEN DESIGNED TO ADDRESS THE RISKS, AND THAT THE OMRON PRODUCT(S) IS PROPERLY RATED AND INSTALLED FOR THE INTENDED USE WITHIN THE OVERALL EQUIPMENT OR SYSTEM.

Programmable Products.

Omron Companies shall not be responsible for the user's programming of a programmable Product, or any consequence thereof.

Performance Data.

Data presented in Omron Company websites, catalogs and other materials is provided as a guide for the user in determining suitability and does not constitute a warranty. It may represent the result of Omron's test conditions, and the user must correlate it to actual application requirements. Actual performance is subject to the Omron's Warranty and Limitations of Liability.

Change in Specifications.

Product specifications and accessories may be changed at any time based on improvements and other reasons. It is our practice to change part numbers when published ratings or features are changed, or when significant construction changes are made. However, some specifications of the Product may be changed without any notice. When in doubt, special part numbers may be assigned to fix or establish key specifications for your application. Please consult with your Omron's representative at any time to confirm actual specifications of purchased Product.

Errors and Omissions.

Information presented by Omron Companies has been checked and is believed to be accurate; however, no responsibility is assumed for clerical, typographical or proofreading errors or omissions.

Note: Do not use this document to operate the Unit.

OMRON Corporation Industrial Automation Company
Tokyo, JAPAN

Contact: www.ia.omron.com

Regional Headquarters

OMRON EUROPE B.V.

Wegalaan 67-69-2132 JD Hoofddorp
The Netherlands
Tel: (31)2356-81-300/Fax: (31)2356-81-388

OMRON ELECTRONICS LLC

One Commerce Drive Schaumburg,
IL 60173-5302 U.S.A.
Tel: (1) 847-843-7900/Fax: (1) 847-843-7787

OMRON ASIA PACIFIC PTE. LTD.

No. 438A Alexandra Road # 05-05/08 (Lobby 2),
Alexandra Technopark,
Singapore 119967
Tel: (65) 6835-3011/Fax: (65) 6835-2711

OMRON (CHINA) CO., LTD.

Room 2211, Bank of China Tower,
200 Yin Cheng Zhong Road,
PuDong New Area, Shanghai, 200120, China
Tel: (86) 21-5037-2222/Fax: (86) 21-5037-2200

Authorized Distributor:

© OMRON Corporation 2009-2014 All Rights Reserved.
In the interest of product improvement,
specifications are subject to change without notice.

Cat. No. P061-E1-09

1214 (0309)

X-ON Electronics

Largest Supplier of Electrical and Electronic Components

Click to view similar products for [Controllers](#) category:

Click to view products by [Omron](#) manufacturer:

Other Similar products are found below :

[CS1WCN223](#) [CS1WCN713](#) [CS1WKS001E](#) [61F-11NH](#) [61FGPN8DAC120](#) [61F-GP-NT AC110](#) [61F-GPN-V50-AC110](#) [70177-1011](#) [F03-03](#)
[HAS B](#) [F03-03 HAS C](#) [F03-31](#) [81513201](#) [81513535](#) [81550401](#) [FT1A-C12RA-W](#) [88981106](#) [H2CAC24A](#) [R88A-CAGA005S](#) [R88A-](#)
[CRGB003CR-E](#) [R88ARR080100S](#) [R88A-TK01K](#) [DCN1-1](#) [DTB4896VRE](#) [DTB9696CVE](#) [DTB9696LVE](#) [MR-50LF+](#) [E53-AZ01](#) [E53E8C](#)
[E5CWLQ1TCAC100240](#) [B300LKL21](#) [NE1ASCPU02EIPVER11](#) [NE1SCPU01](#) [NE1SDRM21U](#) [NSCXDC1V3](#) [NSH5-232CW-3M](#)
[NT20SST122BV1](#) [NV3Q-SW41](#) [NV4W-ATT01](#) [NV-CN001](#) [OAS-160-N](#) [K31S6](#) [K33-L1B](#) [K3TX-AD31A](#) [L595020](#) [SRS2-1](#) [G32X-V2K](#)
[26546803](#) [26546805](#) [26546831](#) [CJ1W-OD204](#)