

Features

2 Pole Changeover (DPDT)
30 A Power relay

- 66.22** PCB connections & mount
- 66.82** Faston 250 connections
- Flange mount
- 66.82-xx07** Faston 250 connections
- 35 mm rail mount

- Reinforced insulation between coil and contacts according to EN 60335-1;
8 mm creepage and clearance distances
- AC coils & DC coils
- Cadmium Free option available

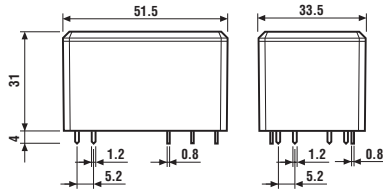

66.22

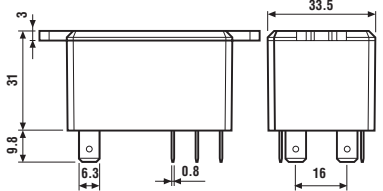

66.82-xxxx

FOR UL HORSEPOWER AND PILOT DUTY RATINGS
SEE "General technical information" page V

Contact specification

Contact configuration	2 CO (DPDT)		
Rated current/Maximum peak current	A	30/50 (NO) - 10/20 (NC)	30/50 (NO) - 10/20 (NC)
Rated voltage/Maximum switching voltage V AC		250/440	250/440
Rated load AC1	VA	7,500 (NO) - 2,500 (NC)	7,500 (NO) - 2,500 (NC)
Rated load AC15 (230 V AC)	VA	1,200 (NO)	1,200 (NO)
Single phase motor rating (230 V AC)	kW	1.5 (NO)	1.5 (NO)
Breaking capacity DC1: 30/110/220 V	A	25/0.7/0.3 (NO)	25/0.7/0.3 (NO)
Minimum switching load	mW (V/mA)	1,000 (10/10)	1,000 (10/10)
Standard contact material		AgCdO	AgCdO

Coil specification

Nominal voltage (U _N)	V AC (50/60 Hz)	6 - 12 - 24 - 110/115 - 120/125 - 230 - 240		
	V DC	6 - 12 - 24 - 110 - 125		
Rated power AC/DC	VA (50 Hz)/W	3.6/1.7	3.6/1.7	3.6/1.7
Operating range	AC	(0.8...1.1)U _N	(0.8...1.1)U _N	(0.8...1.1)U _N
	DC	(0.8...1.1)U _N	(0.8...1.1)U _N	(0.8...1.1)U _N
Holding voltage	AC/DC	0.8 U _N /0.5 U _N	0.8 U _N /0.5 U _N	0.8 U _N /0.5 U _N
Must drop-out voltage	AC/DC	0.2 U _N /0.1 U _N	0.2 U _N /0.1 U _N	0.2 U _N /0.1 U _N

Technical data

Mechanical life AC/DC	cycles	10 · 10 ⁶	10 · 10 ⁶	10 · 10 ⁶
Electrical life at rated load AC1	cycles	100 · 10 ³	100 · 10 ³	100 · 10 ³
Operate/release time	ms	8/15	8/15	8/15
Insulation between coil and contacts (1.2/50 μs)	kV	6 (8 mm)	6 (8 mm)	6 (8 mm)
Dielectric strength between open contacts	V AC	1,500	1,500	1,500
Ambient temperature range	°C	-40...+70	-40...+70	-40...+70
Environmental protection		RT II	RT II	RT II

Approvals (according to type)



66.22



- 30 A rated contacts
- PCB mount - bifurcated terminals

66.82



- 30 A rated contacts
- Flange mount
- Faston 250 connections

66.82-xx07



- 30 A rated contacts
- 35 mm rail mount
- Faston 250 connections

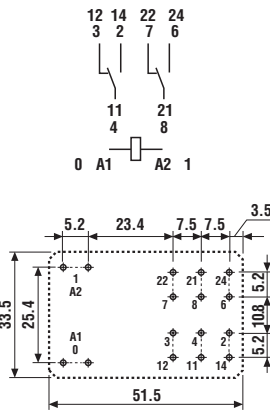

Copper side view

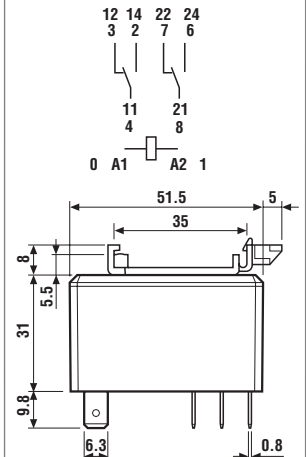
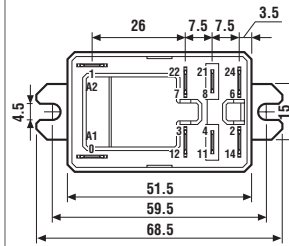

Features

2 Pole NO (DPST-NO)
30 A Power relay

- 66.22-x300 PCB mount
- 66.82-x300 Faston 250 connections - Flange mount
- 66.82-x307 Faston 250 connections - 35 mm rail mount

- Reinforced insulation between coil and contacts according to EN 60335-1; 8 mm creepage and clearance distances
- AC coils & DC coils
- Cadmium Free option available

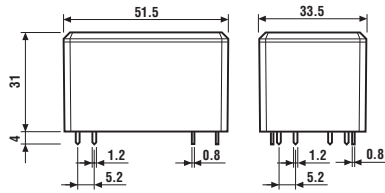

66.22-0300

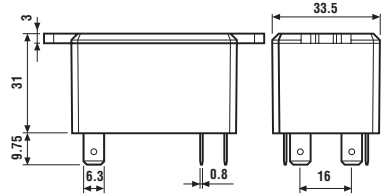

66.82-0300

FOR UL HORSEPOWER AND PILOT DUTY RATINGS
SEE "General technical information" page V

66.22-x300



- 30 A rated contacts
- PCB mount - bifurcated terminals

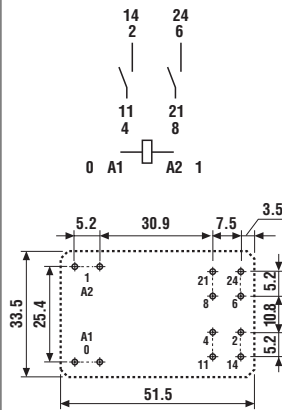

Copper side view

66.82-x300



- 30 A rated contacts
- Flange mount
- Faston 250 connections

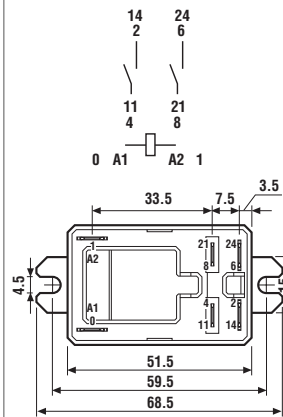

66.82-x307



- 30 A rated contacts
- 35 mm rail mount
- Faston 250 connections

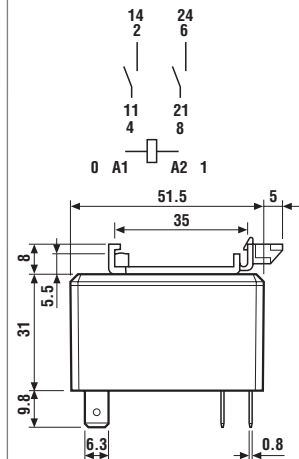

Contact specification				
Contact configuration		2 NO (DPST-NO)	2 NO (DPST-NO)	2 NO (DPST-NO)
Rated current/Maximum peak current	A	30/50	30/50	30/50
Rated voltage/Maximum switching voltage	V AC	250/440	250/440	250/440
Rated load AC1	VA	7,500	7,500	7,500
Rated load AC15 (230 V AC)	VA	1,200	1,200	1,200
Single phase motor rating (230 V AC)	kW	1.5	1.5	1.5
Breaking capacity DC1: 30/110/220 V	A	25/0.7/0.3	25/0.7/0.3	25/0.7/0.3
Minimum switching load	mW (V/mA)	1,000 (10/10)	1,000 (10/10)	1,000 (10/10)
Standard contact material		AgCdO	AgCdO	AgCdO
Coil specification				
Nominal voltage (U _N)	V AC (50/60 Hz)	6 - 12 - 24 - 110/115 - 120/125 - 230 - 240		
	V DC	6 - 12 - 24 - 110 - 125		
Rated power AC/DC	VA (50 Hz)/W	3.6/1.7	3.6/1.7	3.6/1.7
Operating range	AC	(0.8...1.1)U _N	(0.8...1.1)U _N	(0.8...1.1)U _N
	DC	(0.8...1.1)U _N	(0.8...1.1)U _N	(0.8...1.1)U _N
Holding voltage	AC/DC	0.8 U _N /0.5 U _N	0.8 U _N /0.5 U _N	0.8 U _N /0.5 U _N
Must drop-out voltage	AC/DC	0.2 U _N /0.1 U _N	0.2 U _N /0.1 U _N	0.2 U _N /0.1 U _N
Technical data				
Mechanical life AC/DC	cycles	10 · 10 ⁶	10 · 10 ⁶	10 · 10 ⁶
Electrical life at rated load AC1	cycles	100 · 10 ³	100 · 10 ³	100 · 10 ³
Operate/release time	ms	8/10	8/10	8/10
Insulation between coil and contacts (1.2/50 μs)	kV	6 (8 mm)	6 (8 mm)	6 (8 mm)
Dielectric strength between open contacts	V AC	1,500	1,500	1,500
Ambient temperature range	°C	-40...+70	-40...+70	-40...+70
Environmental protection		RT II	RT II	RT II
Approvals (according to type)				

Ordering information

Example: 66 series relay, Faston 250 (6.3x0.8 mm) with top flange mount, 2 CO (DPDT) 30 A contacts, 24 V DC coil.

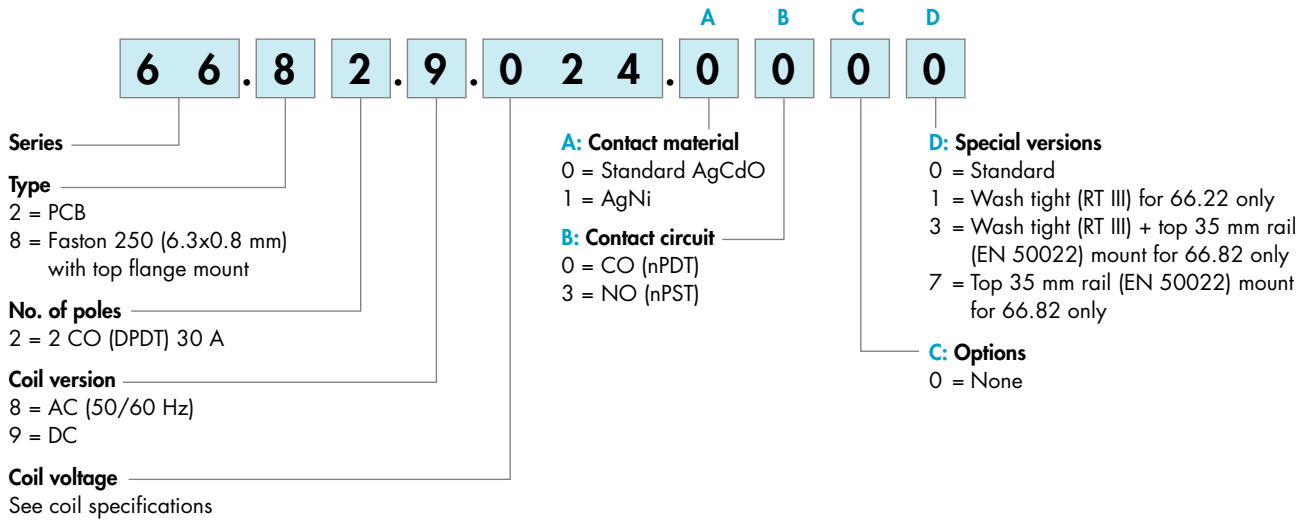

Selecting features and options: only combinations in the same row are possible.
Preferred selections for best availability are shown in **bold**.

Type	Coil version	A	B	C	D
66.22	AC-DC	0 - 1	0 - 3	0	0 - 1
66.82	AC-DC	0 - 1	0 - 3	0	0 - 3 - 7

Technical data

Insulation according to EN 61810-1:2004		
Nominal voltage of supply system	V AC	230/400
Rated insulation voltage	V AC	400
Pollution degree		3
Insulation between coil and contact set		
Type of insulation		Reinforced (8 mm)
Overvoltage category		III
Rated impulse voltage	kV (1.2/50 µs)	6
Dielectric strength	V AC	4,000
Insulation between adjacent contacts		
Type of insulation		Basic
Overvoltage category		III
Rated impulse voltage	kV (1.2/50 µs)	4
Dielectric strength	V AC	2,500
Insulation between open contacts		
Type of disconnection		Micro-disconnection
Dielectric strength	V AC/kV (1.2/50 µs)	1,500/2
Conducted disturbance immunity		
Burst (5...50)ns, 5 kHz, on A1 - A2	EN 61000-4-4	level 4 (4 kV)
Surge (1.2/50 µs) on A1 - A2 (differential mode)	EN 61000-4-5	level 4 (4 kV)
Other data		
Bounce time: NO/NC	ms	7/10
Vibration resistance (10...150)Hz: NO/NC	g	20/19
Shock resistance	g	20
Power lost to the environment	without contact current	W
	with rated current	W
Recommended distance between relays mounted on PCB	mm	≥ 10

Contact specification

F 66 - Electrical life (AC) v contact current
250 V (normally open contact)

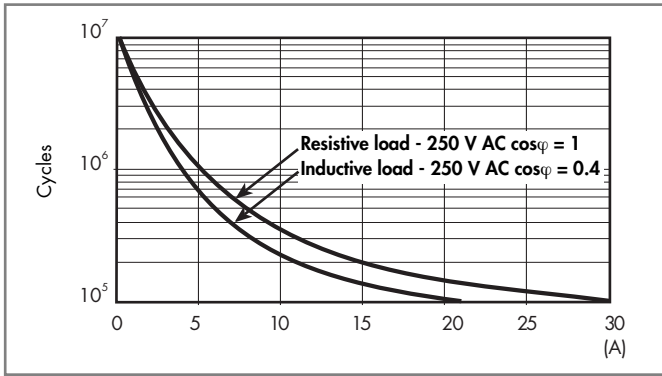

F 66 - Electrical life (AC) v contact current
440 V (normally open contact)

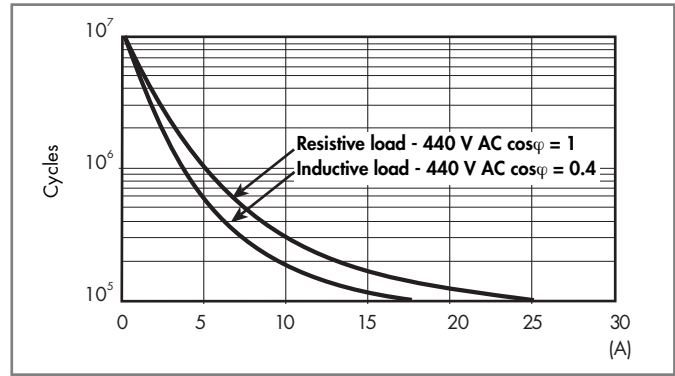

H 66 - Maximum DC1 breaking capacity

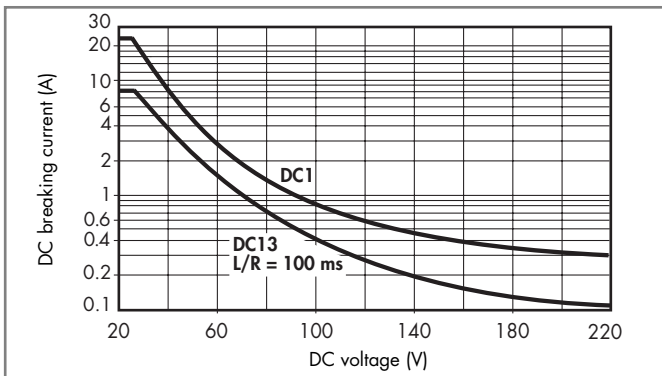

- When switching a resistive load (DC1) having voltage and current values under the curve, an electrical life of $\geq 100 \cdot 10^3$ can be expected.
- In the case of DC13 loads, the connection of a diode in parallel with the load will permit a similar electrical life as for a DC1 load. Note: the release time for the load will be increased.

Coil specifications

DC coil data

Nominal voltage U_N V	Coil code	Operating range		Resistance R Ω	Rated coil consumption I at U_N mA
		U_{min} V	U_{max} V		
6	9.006	4.8	6.6	21	283
12	9.012	9.6	13.2	85	141
24	9.024	19.2	26.4	340	70.5
110	9.110	88	121	7,000	15.7
125	9.125	100	137.5	9,200	13.6

AC coil data

Nominal voltage U_N V	Coil code	Operating range		Resistance R Ω	Rated coil consumption I at U_N (50Hz) mA
		U_{min} V	U_{max} V		
6	8.006	4.8	6.6	3	600
12	8.012	9.6	13.2	11	300
24	8.024	19.2	26.4	50	150
110/115	8.110	88	126	930	32.6
120/125	8.120	96	137	1,050	30
230	8.230	184	253	4,000	15.7
240	8.240	192	264	5,500	15

R 66 - DC coil operating range v ambient temperature

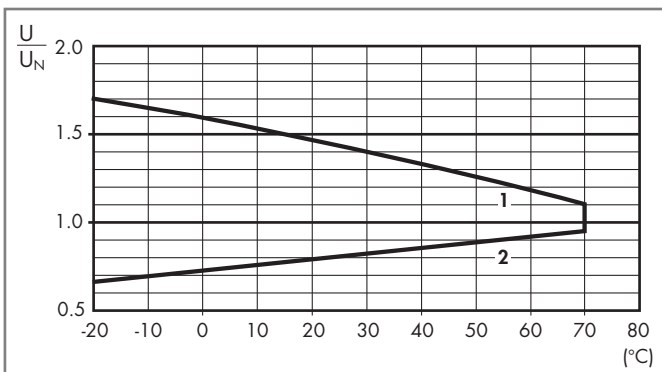

- 1 - Max. permitted coil voltage.
- 2 - Min. pick-up voltage with coil at ambient temperature.

R 66 - AC coil operating range v ambient temperature

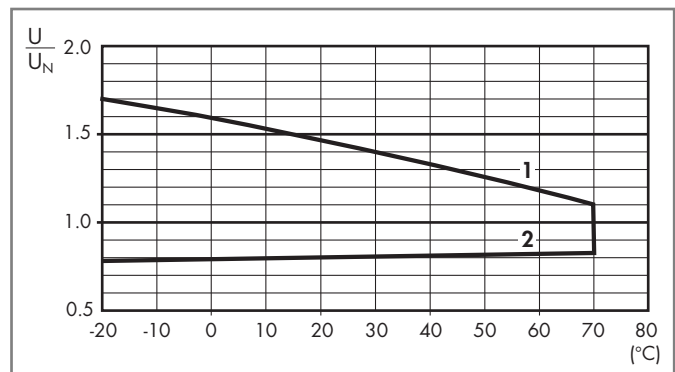

- 1 - Max. permitted coil voltage.
- 2 - Min. pick-up voltage with coil at ambient temperature.

X-ON Electronics

Largest Supplier of Electrical and Electronic Components

Click to view similar products for [Finder manufacturer:](#)

Other Similar products are found below :

[40.52.8.230.5000](#) [60.12.9.012.0040](#) [12.01.8.230.0000](#) [12.11.8.230.1000](#) [12.31.8.230.0000](#) [14.81.8.230.0000](#) [14.71.8.230.0000](#)
[20.21.9.048.4000](#) [20.23.8.012.4000](#) [22.24.9.024.4000](#) [22.34.0.024.4340](#) [22.34.0.024.4720](#) [22.64.0.230.4310](#) [20.21.8.024.4000](#)
[20.21.9.012.4000](#) [20.22.8.024.4000](#) [20.28.8.024.4000](#) [26.06.8.024.0000](#) [27.01.8.230.0000](#) [38.52.0.240.0060](#) [43.41.7.024.4000](#)
[10.42.8.230.0000](#) [10.61.8.230.0000](#) [11.42.8.230.0000](#) [56.34.9.012.0000](#) [56.34.9.024.0000T](#) [60.42.8.230.0000](#) [60.13.4.102.0040](#)
[20.22.9.048.4000](#) [27.05.8.230.0000](#) [40.51.9.048.0000](#) [72.11.8.024.0000](#) [90.12.0.000.0000](#) [77.31.8.230.8050](#) [4CP281100060SPA](#)
[58P482300060SMA](#) [70.31.8.400.2022](#) [83.91.0.240.0000](#) [13.01.8.230.0000](#) [13.12.0.024.0000](#) [22.22.9.048.4000](#) [22.64.0.230.4710](#)
[26.02.8.230.0000](#) [26.03.8.230.0000](#) [20.23.9.110.4000](#) [22.22.8.024.4000](#) [22.22.9.024.4000](#) [22.32.0.230.4440](#) [22.34.0.230.4720](#)
[22.44.0.230.4310](#)