



CQ4

HIGH-PERFORMANCE AND FLEXIBLE SENSOR FOR
MONITORING FILL LEVELS AND DETECTING OBJECTS

Capacitive proximity sensor

SICK
Sensor Intelligence.

CQ4 – COMPACT, HIGH-PERFORMANCE, AND FLEXIBLE

WITH THE CQ4, SICK IS OFFERING A NEW CAPACITIVE PROXIMITY SENSOR THAT OPENS UP A WIDE RANGE OF APPLICATION POSSIBILITIES THANKS TO ITS SPEED, FEATURES, AND MINIATURE DESIGN. FOLLOWING THE W4 PHOTOELECTRIC SENSORS AND THE UC4 ULTRASONIC SENSORS, SICK HAS NOW ALSO PACKED THE CAPACITIVE OPERATING PRINCIPLE INTO A RUGGED, MINIATURE HOUSING NO LARGER THAN A CUBE OF SUGAR. THE RESULT IS THE CQ4 – A FAST, 100 HZ, SPACE-SAVING, RUGGED, AND USER-FRIENDLY SENSOR THAT RELIABLY DETECTS A WIDE RANGE OF OBJECTS AND MATERIALS. THE COMBINATION OF DIFFERENT SWITCHING OUTPUTS AND CONNECTION CONFIGURATIONS ENABLES THE DESIGN ENGINEER TO CHOOSE THE IDEAL CQ4 FROM 12 DIFFERENT VERSIONS.

Features optimized for commissioning and operation

The sensor is as easy to operate as it is small. The sensitivity control can be quickly and easily adjusted via potentiometer. Indicators for operating voltage, switching output, and short-circuit mean that the operational status is clearly visible at all times. The rugged fiber-glass housing with an IP 67 enclosure rating and metal fastening threads ensures reliable operation in industrial applications. Plus, its miniature size is ideal for applications with limited mounting space and it enables design engineers to implement the ideal detection principle for the task at hand using the same drilling pattern and connection diagram. The accessories – mounting brackets for floor or wall mounting and a ball clamp mount – are identical for all versions. To facilitate mounting using cable ties to a plastic pipe or a container wall, as is common in many places, the CQ4 has a guiding groove that keeps the sensor firmly in place.

At home in a wide range of applications

The CQ4 can be used to perform an extremely wide range of tasks due to its space-saving, user-friendly, and reliable design. It can reliably detect wafers in electronics and solar manufacturing, as well as detect objects in food and beverage, pharmaceutical, and cosmetics packaging applications. As a capacitive sensor, the CQ4 can perform detection through non-metallic surfaces. It is also suitable for fill level monitoring of ink cartridges in printing machines or containers and supply lines for rubber and plastic granules.



CQ4 FOR DETECTING OBJECTS AND MONITORING FILL LEVELS

Advantages in everyday use

- Reliable detection of objects thanks to a high switching frequency, even in high-speed production processes
- Quick and easy sensitivity control to adapt to changing conditions
- High reliability thanks to a rugged, fiber-glass reinforced housing that withstands tough industrial environments
- Few installation space requirements thanks to compact design for use in restricted spaces
- Short installation time and no holes in the container or tank walls thanks to non-contact measurement

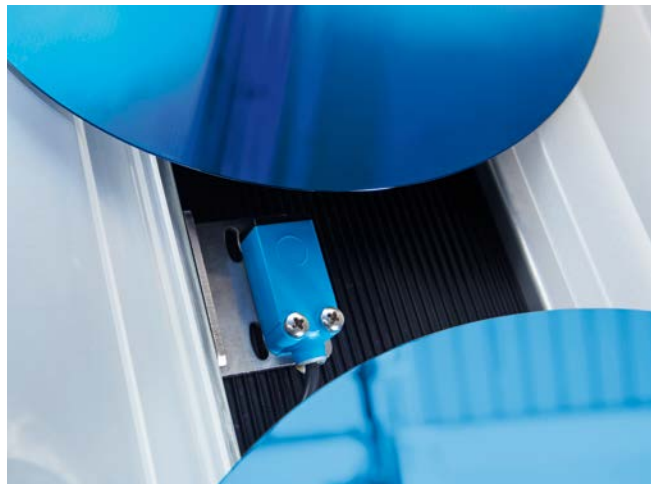

CQ4: Properties at a glance

- High switching frequency of 100 Hz
- 8 mm switching distance
- Quick and easy sensitivity adjustment via potentiometer
- Flexible mounting using cable ties
- Visual alarm indicates a short-circuit
- Power and switching output LEDs for operating voltage and switching output
- Rugged fiber-glass housing
- Operating temperatures up to +75 °C
- Flush installation in all materials is possible



HIGH PERFORMANCE IN PRACTICAL, RECT-ANGULAR, MINIATURE HOUSING



Product description

The CQ4 can be used to perform an extremely wide range of tasks in a space-saving, user-friendly and reliable manner. This includes detection of light-absorbing wafers in electronics and solar manufacturing, as well as object detection in food, drink, pharmaceutical

and cosmetics packaging. As the CQ4, as a capacitive sensor, can perform detection through non-metallic walls, it is also outstandingly suitable for filling level control for tanks in printing machines or containers and supply lines for rubber and plastic granules.

At a glance

- High switching frequency of 100 Hz
- Quick and easy sensitivity adjustment via potentiometer
- Visual alarm in event of short-circuit
- Reinforced glass-fiber housing
- Operating temperatures up to +75 °C
- Sensor can be installed flush in all materials
- Recess on rear for mounting a cable tie
- Flush installation in all materials possible
- Sensing range of up to 8 mm

Your benefits

- Reliable detection of objects thanks to high switching frequency, even in accelerated production processes
- Simple and fast sensitivity control for adaptation to prevailing conditions
- High reliability thanks to rugged, glass-fiber reinforced housing, proven in hard industrial use
- Minimal installation space requirements thanks to compact design for use in restricted spaces
- Short installation time and no holes in the container or tank walls thanks to non-contact measurement



Additional information

Detailed technical data	5
Ordering information	6
Dimensional drawings	6
Connection diagram	6
Accessories	7

→ www.mysick.com/en/CQ4

For more information, just enter the link or scan the QR code and get direct access to technical data, CAD design models, operating instructions, software, application examples and much more.



Detailed technical data

Features

Housing	Rectangular
Dimensions (W x H x D)	16 mm x 39.5 mm x 12 mm
Sensing range S_n¹⁾	8 mm
Assured sensing range S_a	5.76 mm ²⁾ 4.32 mm ³⁾
Installation type	Non-flush Flush
Output function	NO / NC
Switching frequency	100 Hz
Output type	PNP / NPN (depending on type)
Electrical wiring	DC 3-wire
Sensitivity adjustment	Potentiometer, 5-turn
Enclosure rating⁴⁾	IP 67

¹⁾ For flush mounting S_n appr. 6 mm.

²⁾ For non-flush mounting.

³⁾ For flush mounting.

⁴⁾ According to EN 60529.

Mechanics/electronics

Supply voltage	10 V DC ... 30 V DC
Ripple	≤ 10 %
Voltage drop¹⁾	≤ 2.5 V DC
Current consumption²⁾	≤ 12 mA
Time delay before availability	≤ 200 ms
Hysteresis	4 % ... 20 %
Repeatability^{3) 4)}	≤ 5 %
Temperature drift (% of S_r)	± 20 %
EMC	According to EN 60947-5-2
Output current I_a	≤ 150 mA
Connection type	Cable, 2 m, PVC ⁵⁾ Connector, M8 Cable with connector, M8, 2 m, PVC ⁵⁾ (depending on type)
Short-circuit protection	I
Reverse polarity protection	I
Power-up pulse protection	I
Shock/vibration	30 g, 11 ms / 10 ... 55 Hz, 1 mm
Ambient operating temperature	-20 °C ... +75 °C
Ambient storage temperature	-40 °C ... +85 °C
Housing material	ABS, fiber-glass reinforced

¹⁾ At I_a max.

²⁾ Without load.

³⁾ Of S_r .

⁴⁾ U_b and T_a constant.

⁵⁾ Do not bend below 0 °C.

Reduction factors

Note	The values are reference values which may vary
Metal	1
Water	1
PVC	Approx. 0.4
Oil	Approx. 0.25

Ordering information

CQ4

- **Housing:** 16 mm x 39.5 mm x 12 mm
- **Sensing range S_n :** 8 mm
- **Installation type:** non-flush, flush

Output function	Output type	Connection	Connection diagram	Model name	Part no.
NO	PNP	Cable, 3-wire, 2 m, PVC	Cd-043	CQ4-08EPSKU1	6051009
		Connector M8, 3-pin	Cd-045	CQ4-08EPSKT1	6051004
		Cable with connector M8, 3-pin, 2 m, PVC	Cd-045	CQ4-08EPSKP1	6051000
	NPN	Cable, 3-wire, 2 m, PVC	Cd-043	CQ4-08ENSKU1	6051011
		Connector M8, 3-pin	Cd-045	CQ4-08ENSKT1	6051006
		Cable with connector M8, 3-pin, 2 m, PVC	Cd-045	CQ4-08ENSKP1	6051002
NC	PNP	Cable, 3-wire, 2 m, PVC	Cd-043	CQ4-08EPOKU1	6051010
		Connector M8, 3-pin	Cd-045	CQ4-08EPOKT1	6051005
		Cable with connector M8, 3-pin, 2 m, PVC	Cd-045	CQ4-08EPOKP1	6051001
	NPN	Cable, 3-wire, 2 m, PVC	Cd-043	CQ4-08ENOKU1	6051012
		Connector M8, 3-pin	Cd-045	CQ4-08ENOKT1	6051007
		Cable with connector M8, 3-pin, 2 m, PVC	Cd-045	CQ4-08ENOKP1	6051003

Dimensional drawings (Dimensions in mm (inch))

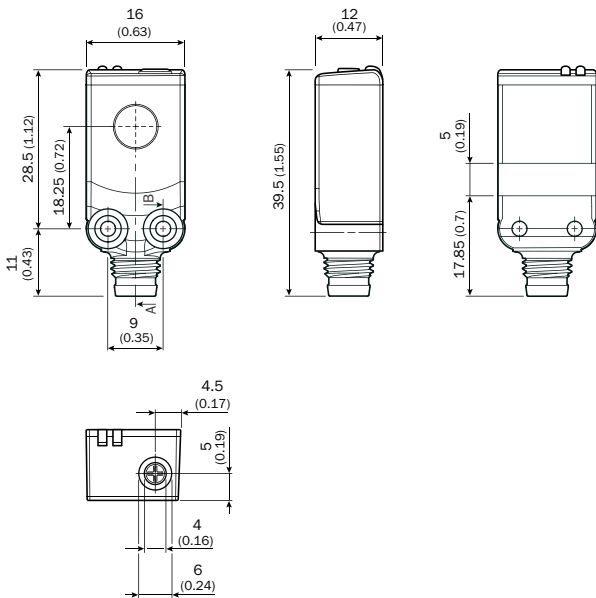

Connection diagram

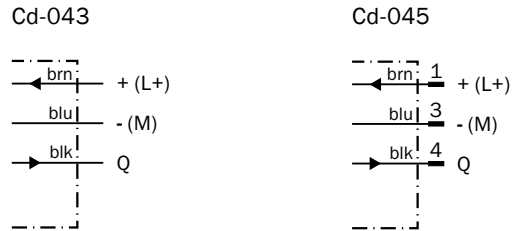



Accessories

Mounting brackets/plates

Mounting brackets



- **Material:** Stainless steel 1.4571
- **Items supplied:** Mounting hardware included

Figure	Description	Model name	Part no.
	Mounting bracket for wall mounting	BEF-W4-A	2051628
	Mounting bracket for floor mounting	BEF-W4-B	2051630

Plug connectors and cables



Connecting cable (female connector-open)

- **Connection type head B:** cable
- **Jacket material:** PVC
- **Enclosure rating:** IP 67
- **Locking nut material:** CuZn
- **Connector material:** TPU

Figure	Connection type head A	Cable length	Model name	Part no.
	Female connector, M8, 3-pin, straight	2 m	DOL-0803-G02M	6010785
		5 m	DOL-0803-G05M	6022009
		10 m	DOL-0803-G10M	6022011
		15 m	DOL-0803-G15M	6036472
	Female connector, M8, 3-pin, angled	2 m	DOL-0803-W02M	6008489
		5 m	DOL-0803-W05M	6022010
		10 m	DOL-0803-W10M	6022012
		15 m	DOL-0803-W15M	6036473

Female connector (ready to assemble)

- **Connection type head B:** -
- **Enclosure rating:** IP 67
- **Locking nut material:** CuZn
- **Connector material:** PBT

Figure	Connection type head A	Model name	Part no.
	Female connector, M8, 3-pin, straight	DOS-0803-G	7902077
	Female connector, M8, 3-pin, angled	DOS-0803-W	7902078

Male connector (ready to assemble)

- **Connection type head A:** Connector, M8, 3-pin, straight

Figure	Connection type head B	Enclosure rating	Locking nut material	Connector material	Model name	Part no.
	-	IP 67	CuZn	PBT	STE-0803-G	6037322

Terminal and alignment brackets

Alignment brackets

Figure	Description	Material	Items supplied	Model name	Part no.
	Ball clamp bracket	Plastic	Mounting hardware included	BEF-GH-MINI01	2023160

Dimensional drawings mounting brackets/plates

BEF-W4-A

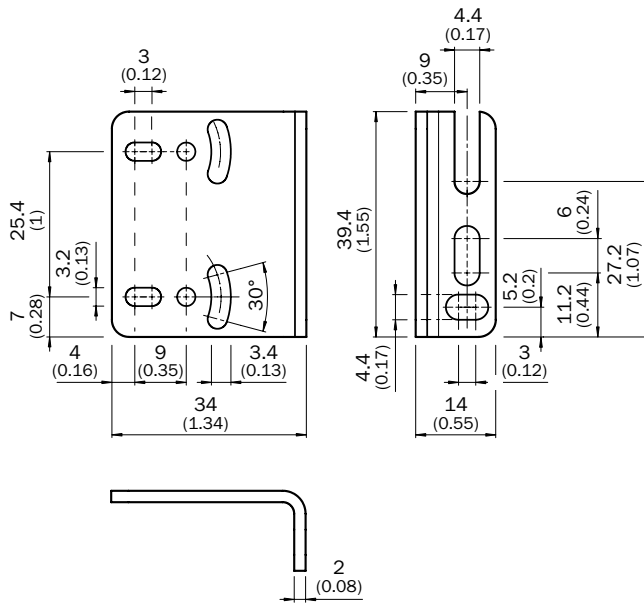

BEF-W4-B

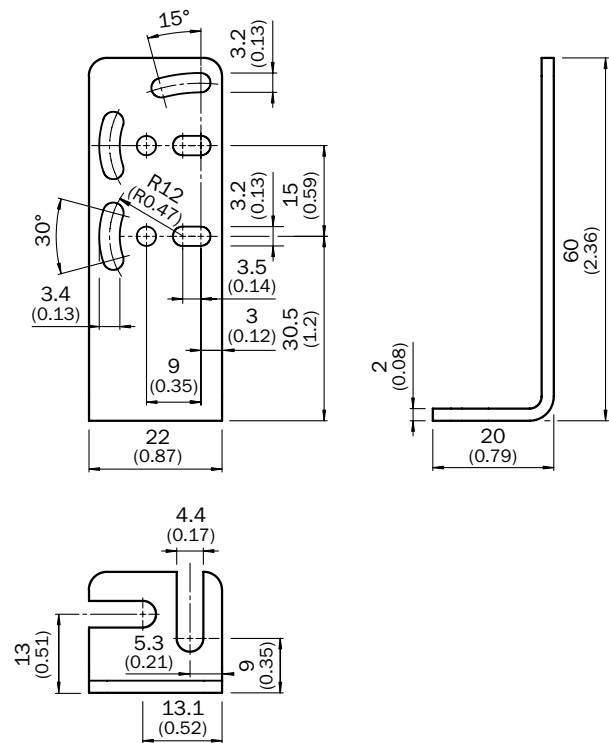

Dimensional drawings connectors and cables

DOL-0803-GxxM

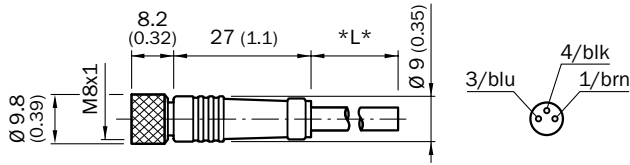

DOL-0803-WxxM

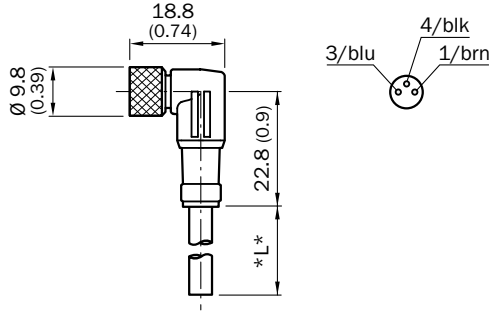

DOS-0803-G

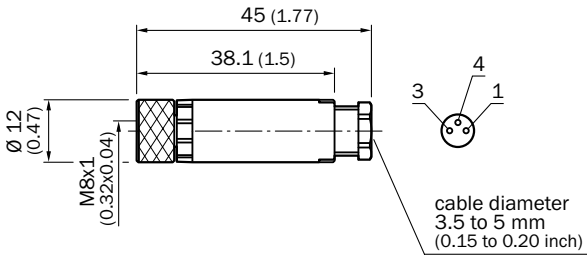

DOS-0803-W

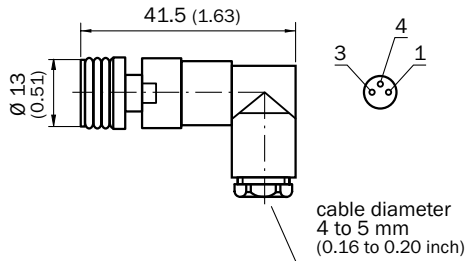

STE-0803-G

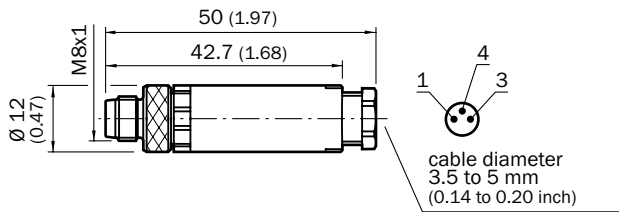

Dimensional drawings terminal and alignment brackets

BEF-GH-MINI01

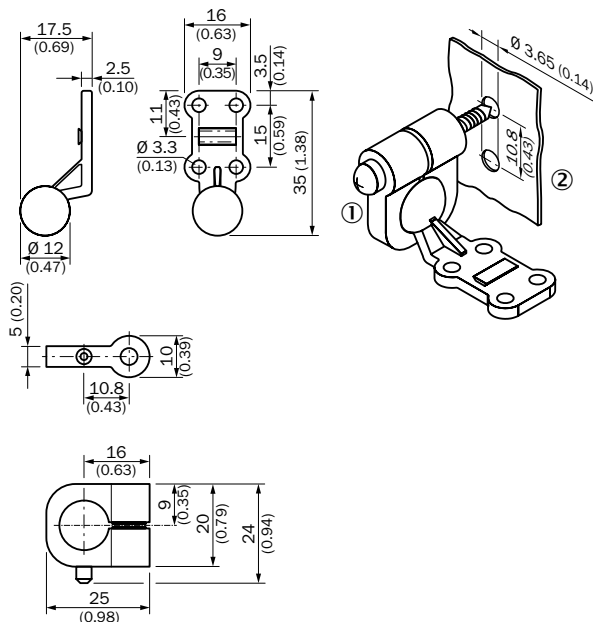

- ① Self-tapping screw Ø 4mm
- ② System or machine part

WWW.MYSICK.COM – SEARCH ONLINE AND ORDER

Search online quickly and safely - with the SICK “Finders”

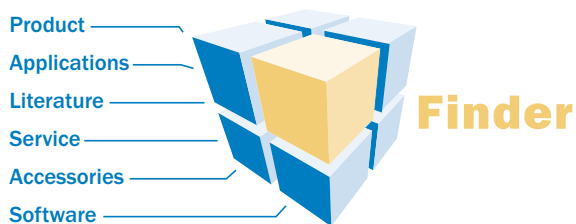

Product Finder: We can help you to quickly target the product that best matches your application.

Applications Finder: Select the application description on the basis of the challenge posed, industrial sector, or product group.

Literature Finder: Go directly to the operating instructions, technical information, and other literature on all aspects of SICK products.

Efficiency – with the E-Commerce-Tools from SICK

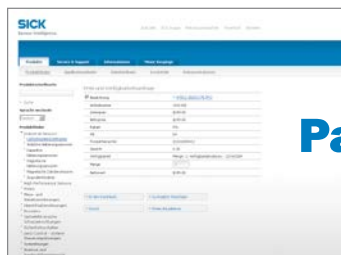

Find out prices and availability

Determine the price and possible delivery date of your desired product simply and quickly at any time.

Request or view a quote

You can have a quote generated online here. Every quote is confirmed to you via e-mail.

Order online

You can go through the ordering process in just a few steps.

FOR SAFETY AND PRODUCTIVITY: SICK LIFETIME SERVICES

SICK LifeTime Services is a comprehensive set of high-quality services provided to support the entire life cycle of products and applications from system design all the way to upgrades. These services increase the safety of people, boost the productivity of machines and serve as the basis for our customers’ sustainable business success.



Consulting & Design

Globally available experts for cost-effective solutions



Product & System Support

Fast and reliable, by telephone or on location



Verification & Optimization

Checks and recommendations for increased availability



Upgrade & Retrofits

Uncovers new potential for machines and systems



Training & Education

Employee qualification for increased competitiveness

SICK AT A GLANCE

SICK is a leading manufacturer of intelligent sensors and sensor solutions for factory, logistics, and process automation. With more than 6,000 employees and over 40 subsidiaries worldwide, we are always close our customers. A unique range of products and services creates the perfect basis for controlling processes securely and efficiently, protecting individuals from accidents and preventing damage to the environment.

We have extensive experience in various industries and understand their processes and requirements. With intelligent sensors, we can deliver exactly what our customers need. In application centers in Europe, Asia and North America, system solutions are tested and optimized in accordance with customer specifications. All this makes us a reliable supplier and development partner.

Comprehensive services round out our offering: SICK LifeTime Services provide support throughout the machine life cycle and ensure safety and productivity.

For us, that is “Sensor Intelligence.”

Worldwide presence:

Australia, Belgium/Luxembourg, Brasil, Česká Republika, Canada, China, Danmark, Deutschland, España, France, Great Britain, India, Israel, Italia, Japan, México, Nederland, Norge, Österreich, Polska, România, Russia, Schweiz, Singapore, Slovenija, South Africa, South Korea, Suomi, Sverige, Taiwan, Türkiye, United Arab Emirates, USA.

Please find detailed addresses and additional representatives and agencies in all major industrial nations at: www.sick.com

X-ON Electronics

Largest Supplier of Electrical and Electronic Components

Click to view similar products for [Capacitive Touch Sensors](#) category:

Click to view products by [Sick](#) manufacturer:

Other Similar products are found below :

[CP8186AT](#) [LC717A10AJ-AH](#) [CP7709DT](#) [AT42QT1012-MAH](#) [FK 8-1](#) [SMBTASK3KIT6](#) [LC717A10AR-NH](#) [MCP2036T-I/MG](#) [CP3155T](#)
[QT113BISG](#) [CAP1166-1-CZC-TR](#) [CM12-08EBP-KW1](#) [CR12CN04DPO-E2](#) [CR30SCF10ATO](#) [CR30SCF10DPO](#) [BCS M30BBI2-PSC15D-](#)
[S04K](#) [CA30CAF16PAM1](#) [VC12RN230](#) [XT130B1FBL2](#) [FDC1004DGSR](#) [FDC1004DGST](#) [CR18SCF05DPO](#) [CR30CN15DPO-E2](#)
[VC12RT23010M](#) [CDWM3020ZPM](#) [17-8421-226](#) [VC12RN924](#) [AT42QT1050-MMH](#) [AT42QT1050-MMHR](#) [AT42QT1110-AU](#)
[AT42QT1244-AU](#) [AT42QT1244-AU](#) [AT42QT1481-AUR](#) [OTBA5L](#) [OTBVR81LQD](#) [PBCL22T](#) [SM31RDLBQD](#) [AT42QT1111-MU](#)
[AT42QT1244-MU](#) [AT42QT2100-MUR](#) [AT42QT2120-MMHR](#) [VTBN6LQ](#) [MTCH6102-IMV](#) [CAP1128-1-BP-TR](#) [CA30CAF16PA](#)
[STMPE16M31QTR](#) [STMPE16M31PXQTR](#) [STM8T143-EVAL](#) [XT230A1PAL2](#) [LC717A00AR-NH](#)