

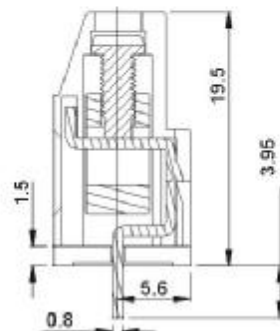

**DG129-7.5**  
**DG129-7.62**

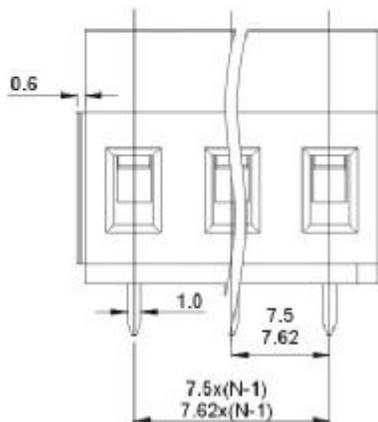
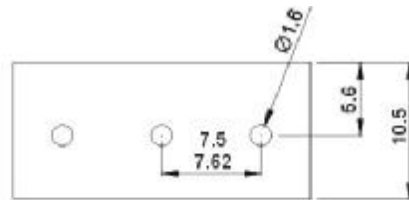
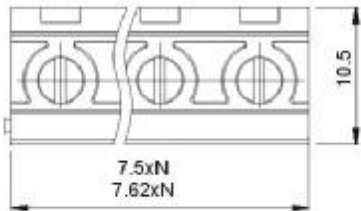

SECTION A-A

<b>APPROVAL</b>		
<b>Electrical</b>		
Standard	<b>U</b>	<b>IEC</b>
Rated voltage	300V	450V
Rated current	20A	20A
Wire range	26-12AWG	0.5-2.5mm <sup>2</sup>
Withstanding voltage	AC2500V/1Min	

<b>Mechanical</b>	
Torque	0.5Nm(4.4Lb-In)
Ambient temperature	-40°C~+105 °C
Strip length	7mm
<b>Dimensions</b>	
pitch	7.5mm(.295" ) 7.62mm(.300" )
Poles	2P,3P-24P

<b>Material</b>	
Housing	PA66,UL94 V-0
Screws	M3,Steel, Cr <sup>3+</sup> Znplated
Pin header	Brass,Tin-plated
Cage	Brass,Ni-plated

### HOW TO ORDER :

-  **P** -   - 

X	X	X
Customer Request		

Series number

No. of pole

1	Single pitch
2	Double pitch

Color

1	Grey	4	Green	7	Trans Parent
2	Blue	5	Orange	8	Yellow
3	Black	6	Red	9	White

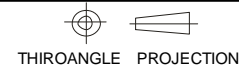
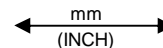

DEGSON ELECTRONICS CO., LTD.

NAME

**DG129-7.5 DG129-7.62**

## X-ON Electronics

Largest Supplier of Electrical and Electronic Components

*Click to view similar products for [Pluggable Terminal Blocks](#) category:*

*Click to view products by [Degson](#) manufacturer:*

Other Similar products are found below :

[57.404.7553](#) [57.504.0053.7](#) [57.510.0053](#) [57.910.6153](#) [01.112.1453](#) [CTB932VE/6](#) [MC 1.5/ 6-ST-3.5 GY AU](#) [ET02015000J0G](#) [734-104](#) [734-304](#) [8-141-P](#) [860505](#) [860516](#) [860810](#) [861908](#) [8726](#) [GBPACX-12](#) [93.731.4953.0](#) [PV05-5,08-K](#) [PVP02-5,00](#) [PVP04-3,50](#) [PVS02-5,00](#) [1-1986160-3](#) [H-10](#) [EC350V-05P](#) [ECH350V-06P](#) [EK381V4L-04P](#) [ELFH09150](#) [ELFH16150](#) [ELFP03110](#) [ELFP10210](#) [ELFT06250](#) [ELFT07250](#) [ELVF09400](#) [ELVP03100](#) [ELXH071G0E](#) [ELXP041G0](#) [ELXT046G0](#) [1700101](#) [1700410](#) [1700425](#) [1703176](#) [1703243](#) [1703634](#) [1705229](#) [1710175](#) [1714537](#) [1719600](#) [1729386](#) [1734692](#)