

REVISION RECORD				
REV	ECN	DESCRIPTION	DRFT	DATE

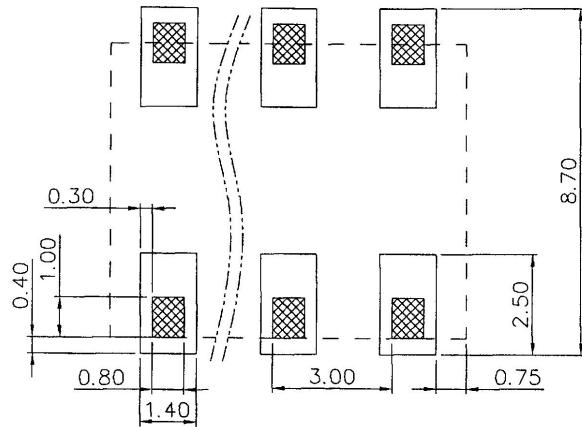

PCB LAYOUT

NOTES1:

UL Standard

- Rated Voltage/Current : 600V/3A(01P)
250V/3A(02P/03P)
- Wire Range : 26~22AWG

IEC Standard

1. Pollution Degree	3	2	2
Overvoltage Category	III	III	II
Rate Impulse Voltage(KV)	2.5KV	2.5KV	2.5KV
Rate Voltage(V)	32V	160V	160V
Rate Current(A)	3A		

- Wire Range : 0.14~0.34mm²

NOTES2:

- Dimension shall be interpreted per ASME Y14.5-2009
- Pitch : 3.0mm, Poles : N=01~03P
- Stripping length : 5.5mm
- Operating temperature: -40°C~+130°C
- Undimensioned Tolerances:

Pitch Range in mm		Nominal Dimension Range in mm				Tolerance		
Over To	Over To	Over To	Over To	Over To	Over To			
6	10	10	24	30	60	100	150	0.1/10
±0.15	±0.20	±0.30	±0.30	±0.50	±0.70	±1.00	±1.30	±2'

- RoHS Compliance

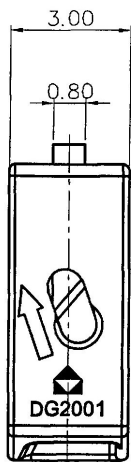

DG2001

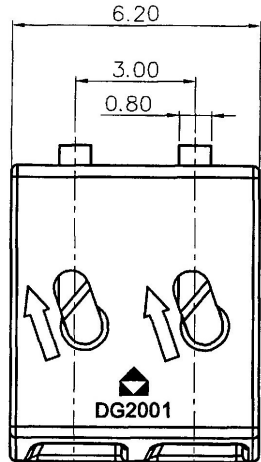

DG2001

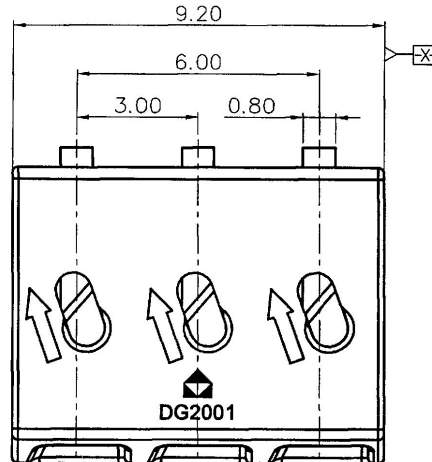

DG2001

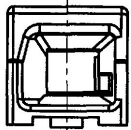

01P

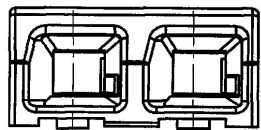

02P

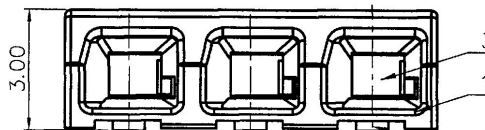

03P

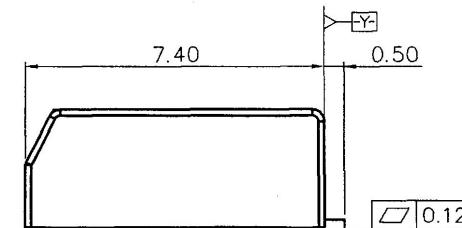

ITEM	NAME OF PART	MATERIAL	NOTES
3	SPRING	STAINLESS STEEL	
2	PIN HEADER	COPPER ALLOY	Sn PLATED
1	HOUSING	LCP	UL94V-0

MM (INCH)		MATERIAL:		宁波高正电子有限公司 DEGSON® DEGSON ELECTRONICS CO., LTD	
TOLERANCES EXCEPT AS NOTED		FINISH:		NAME:	
.X ±	.X' ±	PART NO.:		DG2001-3.0-XXP-1Y-01A(H)	
.XX ±	.XX' ±	APPD: Alan 1/28/15		TITLE: ASSEMBLY DRAWING	
.XXX ±	.XXX' ±	CHKD: Am 12/28/15		DRAWING NO.: DG2001-3.0-C02	
ANGLES ± 1'		DRFT: XLM 04/10/15		REV	D0-1
THIRD ANGLE PROJECTION		DO NOT SCALE DRAWING		SCALE	N/A
		SHEET		1/1	

X-ON Electronics

Largest Supplier of Electrical and Electronic Components

Click to view similar products for [Headers & Wire Housings](#) category:

Click to view products by [Degson](#) manufacturer:

Other Similar products are found below :

[95000-104TRLF](#) [10135584-644402LF](#) [DF62W-EP2022PCA](#) [95000-106TRLF](#) [DF62W-2022SCA](#) [48050-002LF](#) [DF62W-EP2022PC](#) [2203348](#)
[DF62W-2022SC](#) [1084018](#) [1029039](#) [1084017](#) [802-10-012-10-002000](#) [1112640](#) [1112639](#) [000-34000](#) [0008550134](#) [0009482033](#) [0009507031](#)
[0009524054](#) [57102-F02-18ULF](#) [57102-S06-03LF](#) [57202-S52-04LF](#) [PCN6-15S-2.5E](#) [0039019024](#) [58102-G61-06LF](#) [582553-1](#) [0009485154](#)
[0009508121](#) [0022285053](#) [0050291907](#) [018731A](#) [LY20-4P-DT1-P1E-BR](#) [02.125.8002.8](#) [60101931](#) [60598-1 \(Cut Strip\)](#) [M1625-3R/100](#) [61062-3](#)
[61082-181009](#) [636-1427](#) [638009-1](#) [641938-9](#) [641991-4](#) [644168-1](#) [644827-2](#) [647662-1](#) [65039-019ELF](#) [65692-001LF](#) [65781-018](#) [65781-047](#)