

Description

The DGD23892 is a three-phase gate driver IC designed for high-voltage / high-speed applications, driving N-Channel MOSFETs and IGBTs in a half-bridge configuration. High-voltage processing techniques enable the DGD23892's high-side to switch to 600V in a bootstrap operation.

The DGD23892 logic inputs are compatible with standard TTL and CMOS levels (down to 3.3V) for easy interfacing with controlling devices and are enabled low to better function in high-noise environments. The driver outputs feature high-pulse current buffers designed for minimum driver cross conduction.

The DGD23892 offers numerous protection functions. A shoot-through protection logic prevents both outputs from being high when both inputs are high (fault state), an undervoltage lockout (UVLO) for V_{CC} shuts down all drivers through an internal fault control, and a UVLO for V_{BS} shuts down the respective high side output. An overcurrent protection will terminate the six outputs. Both the V_{CC} UVLO and the overcurrent protection trip an automatic fault clear with a timing that is adjustable with an external capacitor.

The DGD23892 is offered in SO-28 (Type TH) package and the operating temperature extends from -40°C to +125°C.

Applications

- 3-Phase Motor Inverter Driver
- White Goods – Air Conditioner, Washing Machine, Refrigerator
- Industrial Motor Inverter – Power Tools, Robotics
- General Purpose 3-Phase Inverter

Features

- Three Floating High-Side Drivers in Bootstrap Operation to 600V
- 350mA Source / 650mA Sink Output Current Capability
- Outputs Tolerant to Negative Transients, dV/dt Immune
- Logic Input 3.3V Capability
- Internal Deadtime of 290ns to Protect MOSFETs
- Matched Prop Delay for All Channels
- Outputs Out of Phase with Inputs
- Schmitt Triggered Logic Inputs
- Cross Conduction Prevention Logic
- Undervoltage Lockout for All Channels
- Overcurrent Protection Shuts Down Drivers
- Extended Temperature Range: -40°C to +125°C
- **Totally Lead-Free & Fully RoHS Compliant (Notes 1 & 2)**
- **Halogen and Antimony Free. "Green" Device (Note 3)**

Mechanical Data

- Case: SO-28 (Type TH)
- Case Material: Molded Plastic. "Green" Molding Compound.
- UL Flammability Classification Rating 94V-0
- Moisture Sensitivity: Level 3 per J-STD-020
- Terminals: Finish – Matte Tin Plated Leads, Solderable per MIL-STD-202, Method 208 Ⓔ
- Weight: 0.250 grams (Approximate)

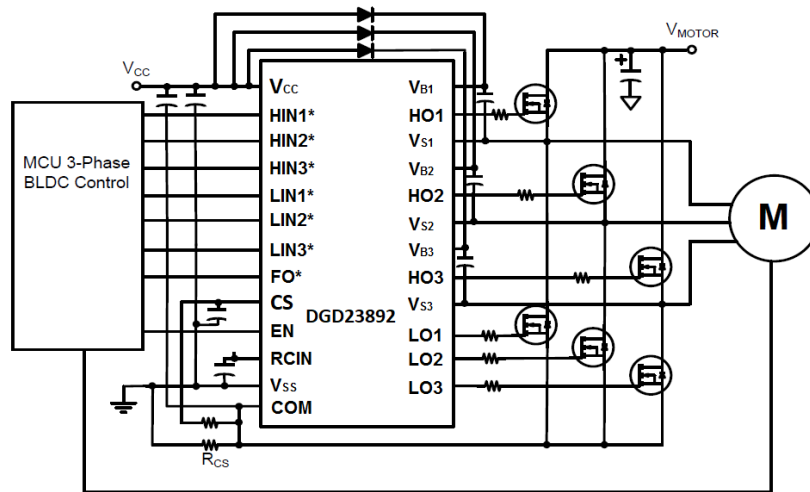

Typical Configuration

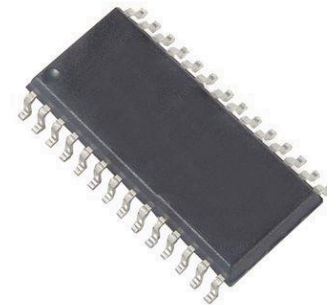

SO-28 (Type TH)

Top View

Ordering Information (Note 4)

| Product | Marking | Reel Size (inches) | Tape Width (mm) | Quantity per Reel |
|----------------|----------|--------------------|-----------------|-------------------|
| DGD23892S28-13 | DGD23892 | 13 | 24 | 1,500 |

- Notes:
1. No purposely added lead. Fully EU Directive 2002/95/EC (RoHS), 2011/65/EU (RoHS 2) & 2015/863/EU (RoHS 3) compliant.
 2. See http://www.diodes.com/quality/lead_free.html for more information about Diodes Incorporated's definitions of Halogen- and Antimony-free, "Green" and Lead-free.
 3. Halogen- and Antimony-free "Green" products are defined as those which contain <900ppm bromine, <900ppm chlorine (<1500ppm total Br + Cl) and <1000ppm antimony compounds.
 4. For packaging details, go to our website at <http://www.diodes.com/products/packages.html>.

Marking Information

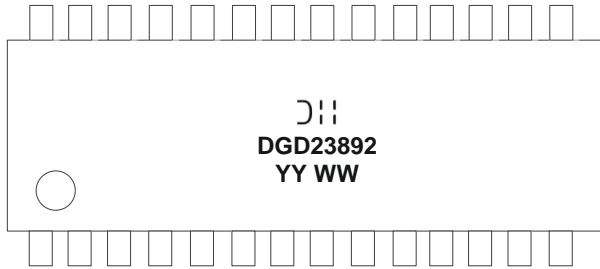

DII = Manufacturer's Marking
 DGD23892 = Product Type Marking Code
 YY = Year (ex: 18 = 2018)
 WW = Week (01 to 53)

Pin Diagrams

Top View

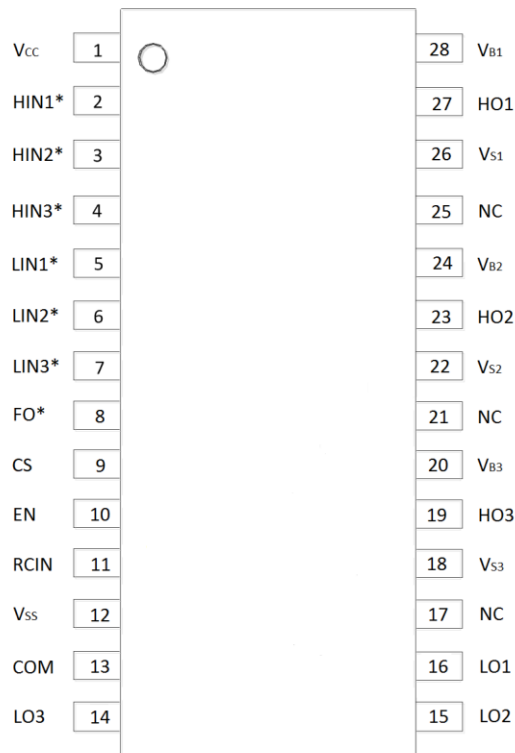

SO-28 (Type TH)

Pin Descriptions

| Pin Number | Pin Name | Function |
|------------|---|--|
| 1 | V _{CC} | Low-Side and Logic Fixed Supply |
| 2,3,4 | HIN1*,HIN2*,HIN3* | Logic Input for High-Side Gate Driver Output, Out of Phase with HO |
| 5,6,7 | LIN1*,LIN2*,LIN3* | Logic Input for Low-Side Gate Driver Output, Out of Phase with LO |
| 8 | FO* | Fault Output with Open Drain (Fault with Overcurrent and V _{CC} UVLO) |
| 9 | CS | Analog Input for Overcurrent Shutdown |
| 10 | EN | Logic Input for Functionality, I/O Logic Functions when EN is High |
| 11 | RCIN | An External RC Network Input used to Define FAULT CLEAR Delay |
| 12 | V _{SS} | Logic Ground |
| 13 | COM | Low-Side Driver Return |
| 14,15,16 | LO3,LO2,LO1 | Low-Side Gate Driver Output |
| 17,21,25 | NC | No Connection (No Internal Connection) |
| 18,22,26 | V _{S3} , V _{S2} , V _{S1} | High-Side Floating Supply Return |
| 19,23,27 | HO3,HO2,HO1 | High-Side Gate Driver Output |
| 20,24,28 | V _{B3} , V _{B2} , V _{B1} | High-Side Floating Supply |

Functional Block Diagram

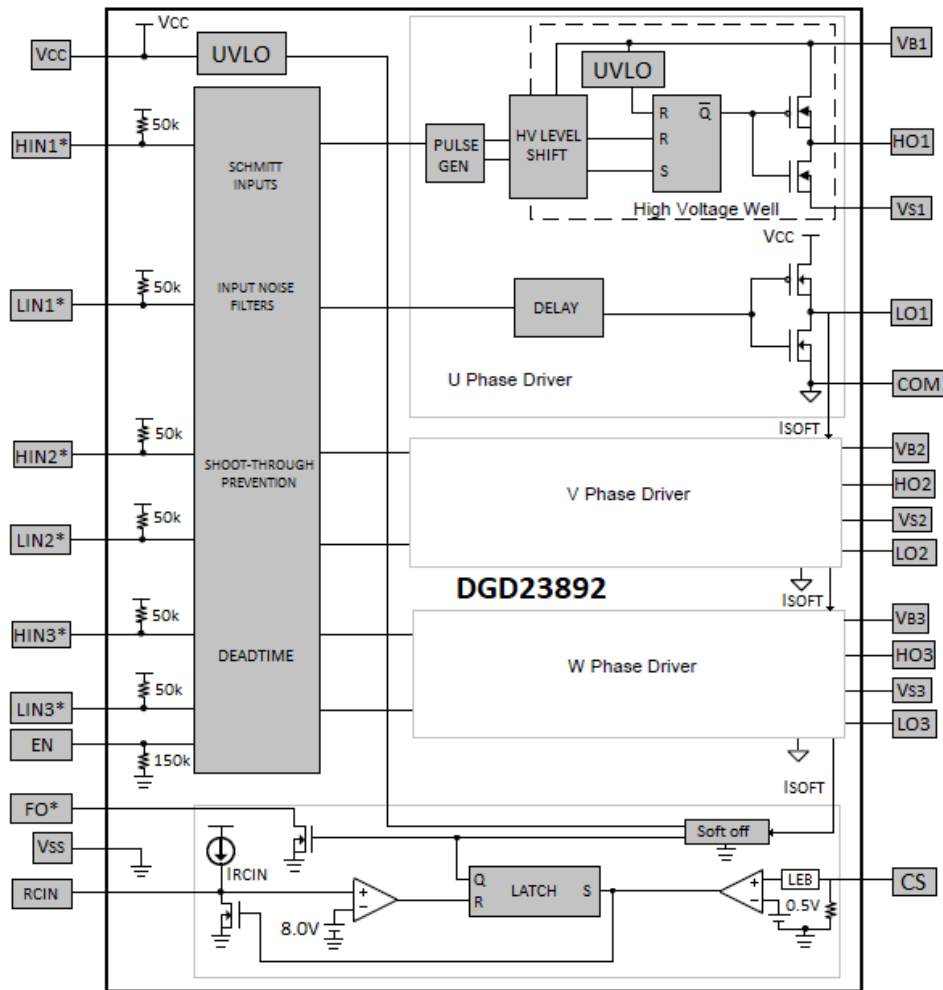

Absolute Maximum Ratings (@T_A = +25°C, unless otherwise specified.)

| Characteristic | Symbol | Value | Unit |
|--|----------------------|--|------|
| High-Side Floating Supply Voltage | V _B | -0.3 to +618 | V |
| High-Side Floating Supply Offset Voltage | V _S | V _B -18 to V _B +0.3 | V |
| High-Side Floating Output Voltage | V _{HO} | V _S -0.3 to V _B +0.3 | V |
| Low-Side Output Voltage | V _{LO} | -0.3 to V _{CC} +0.3 | V |
| Offset Supply Voltage Transient | dV _S / dt | 50 | V/ns |
| Low-Side Fixed Supply Voltage | V _{CC} | -0.3 to +18 | V |
| Logic Input Voltage (HIN*, LIN*, CS, EN and FO*) | V _{IN} | -0.3 to +5.5 | V |

Thermal Characteristics (@T_A = +25°C, unless otherwise specified.)

| Characteristic | Symbol | Value | Unit |
|---|------------------|-------------|------|
| Power Dissipation Linear derating factor (Note 5) | P _D | 2.3 | W |
| Thermal Resistance, Junction to Ambient (Note 5) | R _{θJA} | 60 | °C/W |
| Thermal Resistance, Junction to Case (Note 5) | R _{θJC} | 45 | °C/W |
| Operating Temperature | T _J | +150 | °C |
| Lead Temperature (Soldering, 10s) | T _L | +300 | |
| Storage Temperature Range | T _{STG} | -55 to +150 | |

Note: 5. When mounted on a standard JEDEC 2-layer FR-4 board.

Recommended Operating Conditions

| Parameter | Symbol | Min | Max | Unit |
|--|-----------------|---------------------|---------------------|------|
| High-Side Floating Supply Absolute Voltage | V _B | V _S + 10 | V _S + 15 | V |
| High-Side Floating Supply Offset Voltage | V _S | (Note 6) | 600 | V |
| High-Side Floating Output Voltage | V _{HO} | V _S | V _B | V |
| Low-Side Fixed Supply Voltage | V _{CC} | 10 | 15 | V |
| Low-Side Output Voltage | V _{LO} | COM | V _{CC} | V |
| Logic Input Voltage (HIN*, LIN*, CS & EN) | V _{IN} | V _{SS} | 5 | V |
| Fault Output Voltage | V _{FO} | V _{SS} | V _{CC} | V |
| Logic Ground | V _{SS} | -5 | 5 | V |
| Ambient Temperature | T _A | -40 | +125 | °C |

Note: 6. Logic operation for V_S of -5V to +600V.

DC Electrical Characteristics (V_{BIAS} (V_{CC} , V_{BS}) = 15V, @ T_A = +25°C, unless otherwise specified.) (Note 7)

| Parameter | Symbol | Min | Typ | Max | Unit | Condition |
|---|---------------|-----|-----|-----|----------|----------------------------------|
| Logic "0" Input Voltage | V_{IH} | 2.4 | – | – | V | – |
| Logic "1" Input Voltage | V_{IL} | – | – | 0.8 | V | – |
| High Level Output Voltage, $V_{BIAS} - V_O$ | V_{OH} | – | – | 0.1 | V | $I_O = 0mA$ |
| Low Level Output Voltage, V_O | V_{OL} | – | – | 0.1 | V | $I_O = 0mA$ |
| Offset Supply Leakage Current | I_{LK} | – | – | 10 | μA | $V_B = V_S = 600V$ |
| Quiescent V_{BS} Supply Current | I_{BSQ} | 10 | 85 | 130 | μA | $V_{IN} = 0V$ or 5V, $EN = 0V$ |
| Quiescent V_{CC} Supply Current | I_{CCQ} | – | 1.1 | 1.6 | mA | $V_{IN} = 0V$ or 5V, $EN = 0V$ |
| Logic Input Bias Current (HO=LO=HIGH) | I_{IN+} | – | 130 | 200 | μA | $V_{IN} = 0V$ |
| Logic Input Bias Current (HO=LO=LOW) | I_{IN-} | – | 3.0 | 20 | μA | $V_{IN} = 5V$ |
| Logic Enable "1" Input Bias Current | I_{EN+} | – | 50 | 80 | μA | $V_{EN} = 5V$ |
| Logic Enable "0" Input Bias Current | I_{EN-} | – | – | 2.0 | μA | $V_{EN} = 0V$ |
| V_{BS} Supply Undervoltage Positive Going Threshold | V_{BSUV+} | 7.6 | 8.9 | 9.9 | V | – |
| V_{BS} Supply Undervoltage Negative Going Threshold | V_{BSUV-} | 7.1 | 8.3 | 9.4 | V | – |
| V_{CC} Supply Undervoltage Positive Going Threshold | V_{CCUV+} | 7.6 | 8.9 | 9.9 | V | – |
| V_{CC} Supply Undervoltage Negative Going Threshold | V_{CCUV-} | 7.1 | 8.3 | 9.4 | V | – |
| Output High Short Circuit Pulsed Current | I_{O+} | 250 | 350 | – | mA | $V_O = 0V$, $PW \leq 10\mu s$ |
| Output Low Short Circuit Pulsed Current | I_{O-} | 500 | 650 | – | mA | $V_O = 15V$, $PW \leq 10\mu s$ |
| Overcurrent Detect Positive Threshold | V_{ITH+} | 400 | 500 | 600 | mV | – |
| Overcurrent Detect Negative Threshold | V_{ITH-} | 340 | 420 | 500 | mV | – |
| Short-Circuit Input Current | I_{CSIN} | 5.0 | 15 | 20 | μA | $V_{CSIN} = 1V$ |
| RCIN Internal Current Source | I_{RSIN} | 6.0 | 8.0 | 10 | μA | – |
| RCIN Positive Going Threshold Voltage | $V_{RCINTH+}$ | – | 8.0 | – | V | – |
| RCIN Negative Going Threshold Voltage (Note 8) | $V_{RCINTH-}$ | – | 5.0 | – | V | – |
| Fault Output Low Level Voltage | V_{FOL} | – | 0.2 | 0.5 | V | $V_{CS} = 1V$, $I_{FO} = 1.5mA$ |
| RCIN on Resistance | R_{DSRCIN} | 40 | 75 | 110 | Ω | $I_{RCIN} = 1.5mA$ |
| Fault Output on Resistance | R_{DSFO} | 80 | 130 | 180 | Ω | $I_{FO} = 1.5mA$ |

- Notes: 7. The V_{IN} , V_{TH} and I_{IN} parameters are referenced to V_{SS} and are applicable to all six channels (HIN1*, 2*, 3* and LIN1*, 2*, 3*). The V_O and I_O parameters are applicable to the output pins (HO1, 2, 3 and LO1, 2, 3) and are referenced to COM.
8. Guaranteed by design

AC Electrical Characteristics (V_{BIAS} (V_{CC} , V_{BS}) = 15V, $C_L = 1000pF$, @ T_A = +25°C, unless otherwise specified.)

| Parameter | Symbol | Min | Typ | Max | Unit | Condition |
|--|--------------|-----|-----|-----|------|--|
| Turn-On Propagation Delay | t_{ON} | 200 | 270 | 460 | ns | $V_S = 0V$ |
| Turn-Off Propagation Delay | t_{OFF} | 200 | 270 | 460 | ns | $V_S = 0V$ |
| Turn-On Rise Time | t_R | – | 40 | 150 | ns | $V_S = 0V$ |
| Turn-Off Fall Time | t_F | – | 25 | 60 | ns | $V_S = 0V$ |
| Delay Matching | t_{DM} | – | – | 50 | ns | – |
| Enable Low to Output Shutdown Delay | t_{EN} | 225 | 260 | 425 | ns | – |
| CS Pin Leading-Edge Blanking Time (Note 9) | t_{BLT} | 200 | 300 | 400 | ns | – |
| Time from CS Triggering to FO* | t_{FLT} | 360 | 550 | 760 | ns | From $V_{CS} = 1V$ to FO* turn off |
| Time from CS Triggering to All Gate Outputs Turn Off | t_{ITRIP} | 420 | 615 | 820 | ns | From $V_{CS} = 1V$ to starting gate turn off |
| Input Filtering Time (HIN*, LIN*, EN) | t_{FLTIN} | – | 250 | – | ns | – |
| Fault Clear Time (Note 8) | t_{FLTCLR} | – | 3.1 | – | ms | $C_{RCIN} = 2nF$ |
| Deadtime | t_{DT} | 200 | 290 | 420 | ns | – |
| Deadtime Matching | t_{DTM} | – | – | 50 | ns | – |
| Output Pulse Width Matching (Note 10) | t_{PM} | – | 50 | 75 | ns | $PW_{IN} > 1\mu s$ |

- Note: 9. For best performance of CS and FO* in the application, the CS pulse width should be greater than 1.2 μs
10. t_{PM} is defined as $PW_{IN} - PW_{OUT}$.

Timing Waveforms

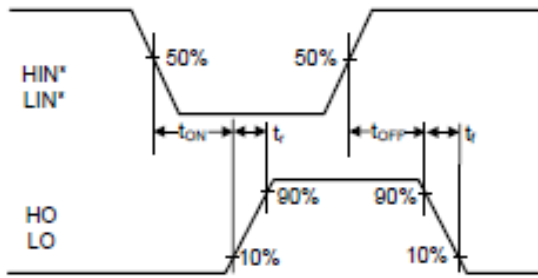

Figure 1. Switching Time Waveform Definitions

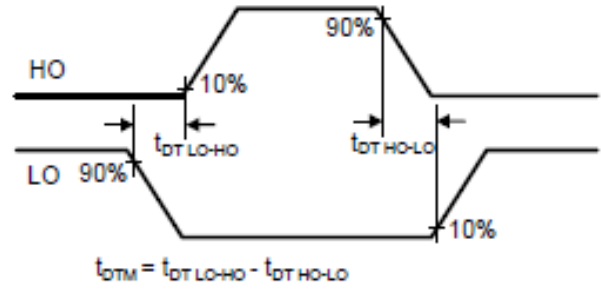

Figure 2. Deadtime Waveform Definitions

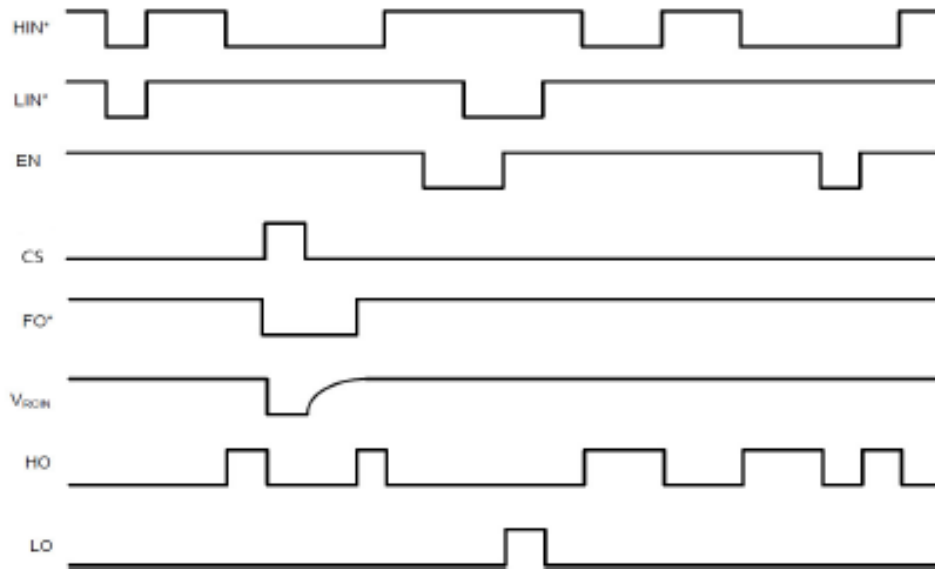

Figure 3. Input/Output Timing Diagram

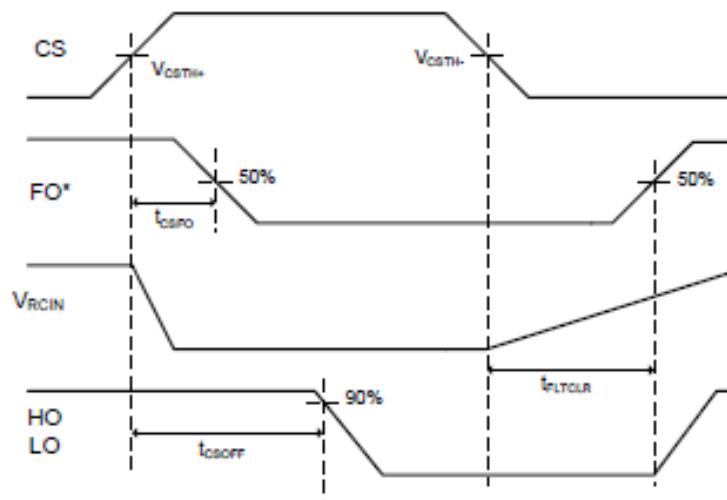

Figure 4. Overcurrent Timing Definitions

Typical Performance Characteristics (@T_A = +25°C, unless otherwise specified.)

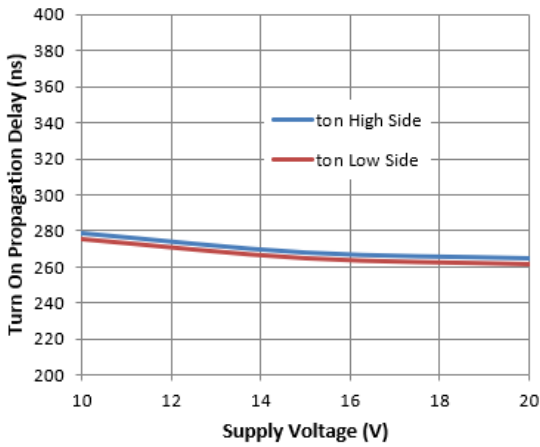

Figure 5. Turn-on Propagation Delay vs. Supply Voltage

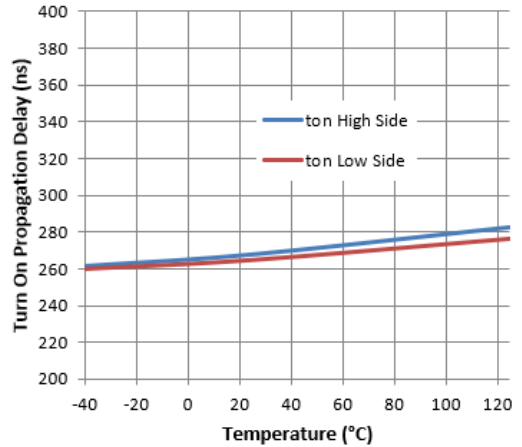

Figure 6. Turn-on Propagation Delay vs. Temperature

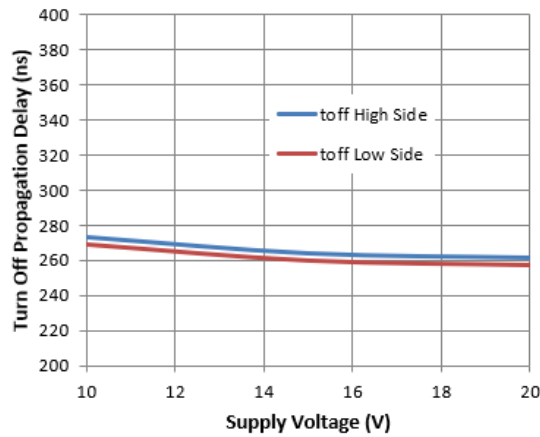

Figure 7. Turn-off Propagation Delay vs. Supply Voltage

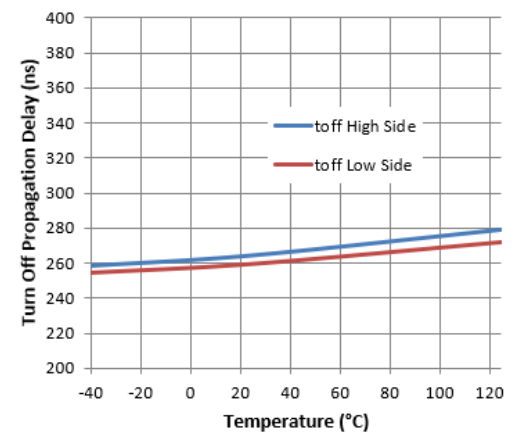

Figure 8. Turn-off Propagation Delay vs. Temperature

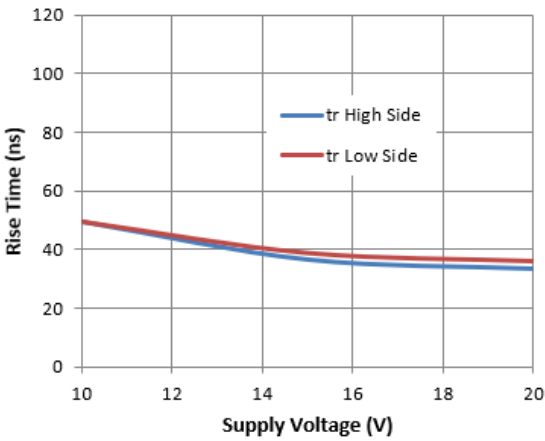

Figure 9. Rise Time vs. Supply Voltage

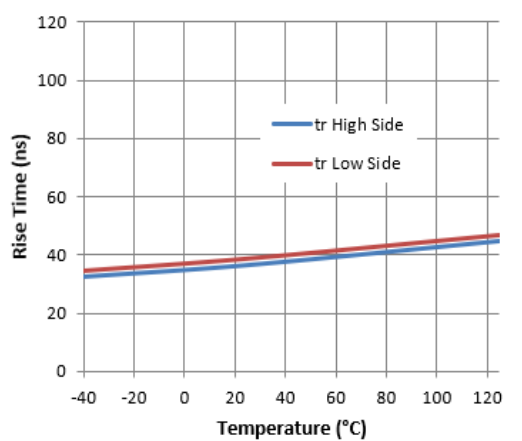

Figure 10. Rise Time vs. Temperature

Typical Performance Characteristics (Continued)

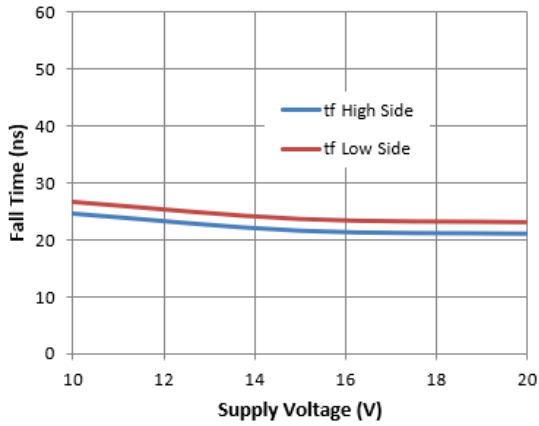

Figure 11. Fall Time vs. Supply Voltage

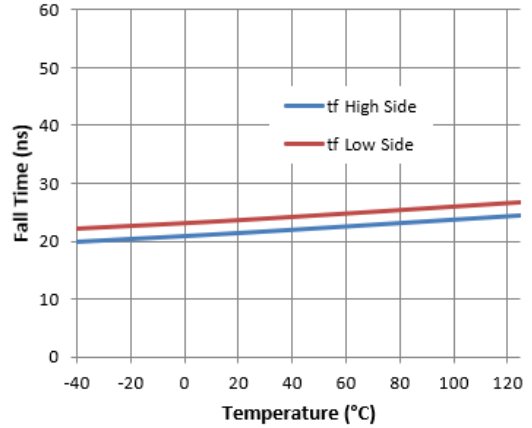

Figure 12. Fall Time vs. Temperature

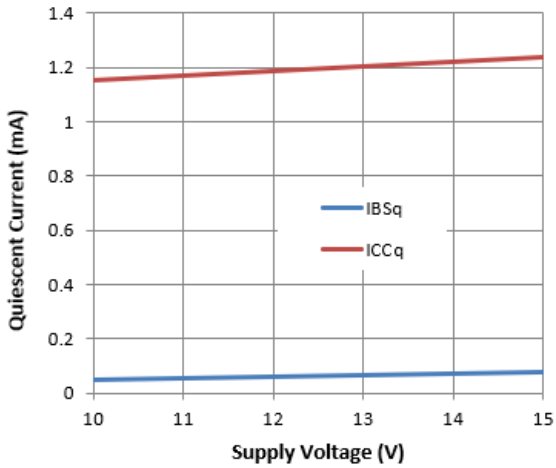

Figure 13. Quiescent Current vs. Supply Voltage

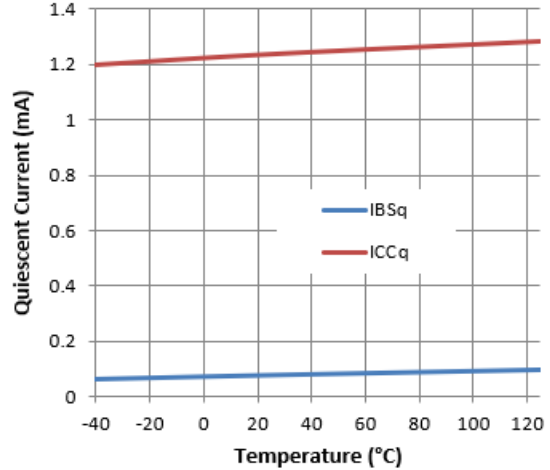

Figure 14. Quiescent Current vs. Temperature

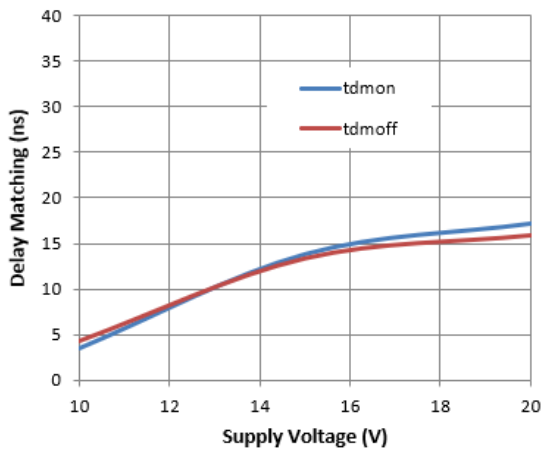

Figure 15. Delay Matching vs. Supply Voltage

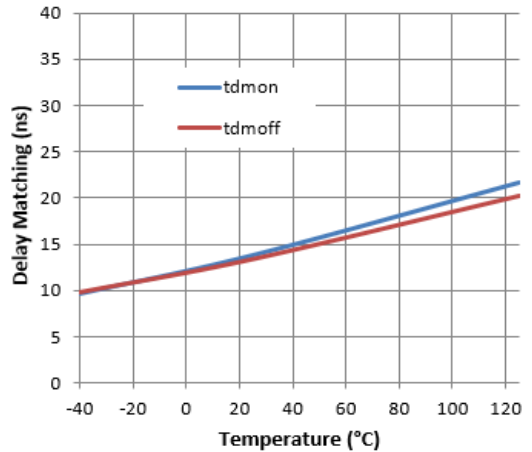

Figure 16. Delay Matching vs. Temperature

Typical Performance Characteristics (Cont.)

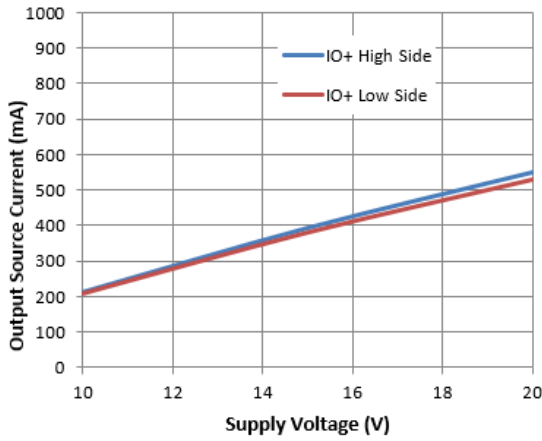

Figure 17. Output Source Current vs. Supply Voltage

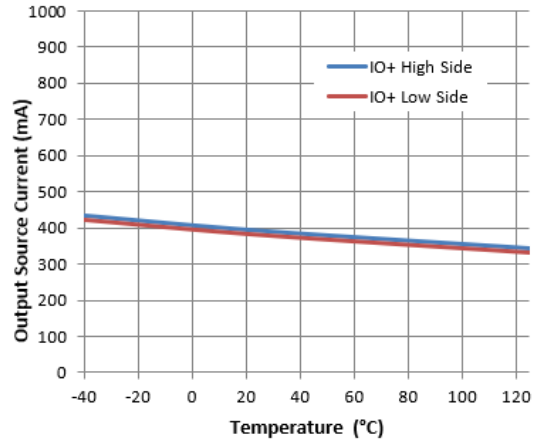

Figure 18. Output Source Current vs. Temperature

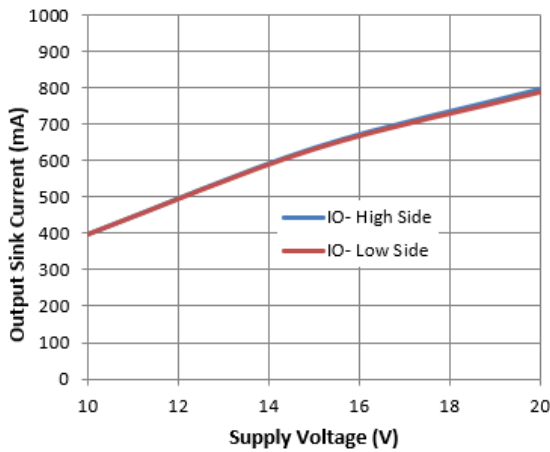

Figure 19. Output Sink Current vs. Supply Voltage

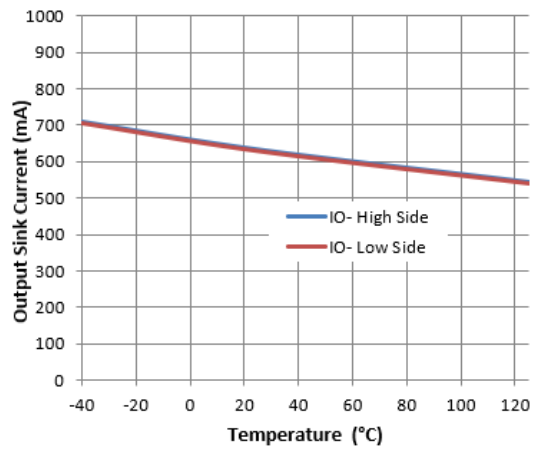

Figure 20. Output Sink Current vs. Temperature

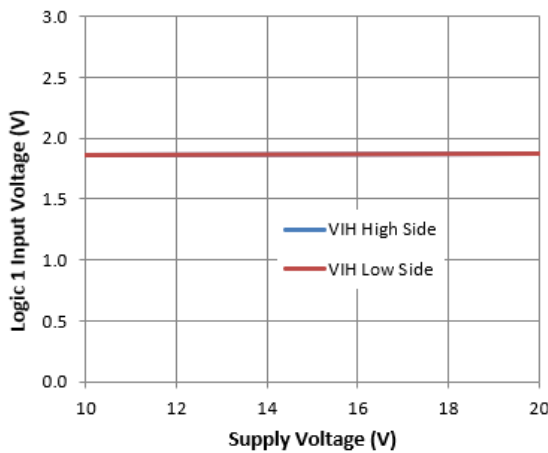

Figure 21. Logic 1 Input Voltage vs. Supply Voltage

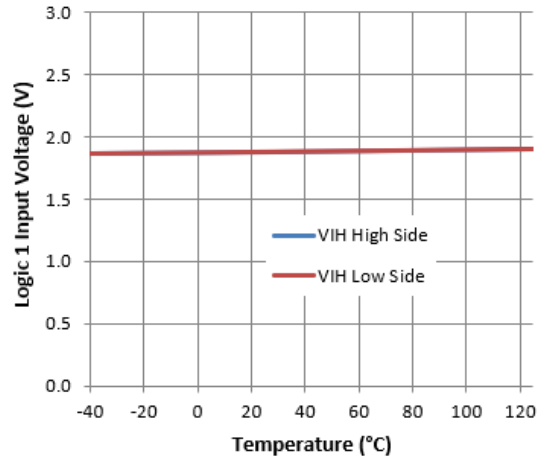

Figure 22. Logic 1 Input Voltage vs. Temperature

Typical Performance Characteristics (Cont.)

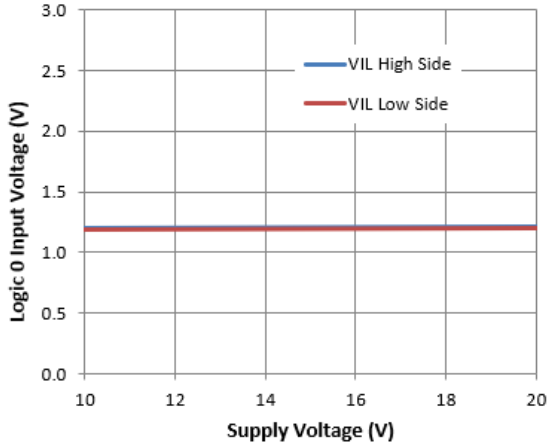

Figure 23. Logic 0 Input Voltage vs. Supply Voltage

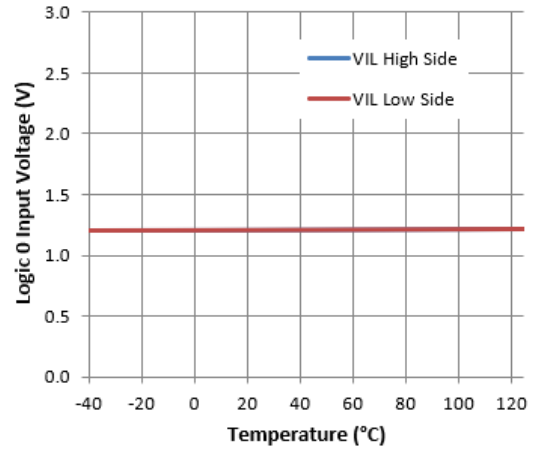

Figure 24. Logic 0 Input Voltage vs. Temperature

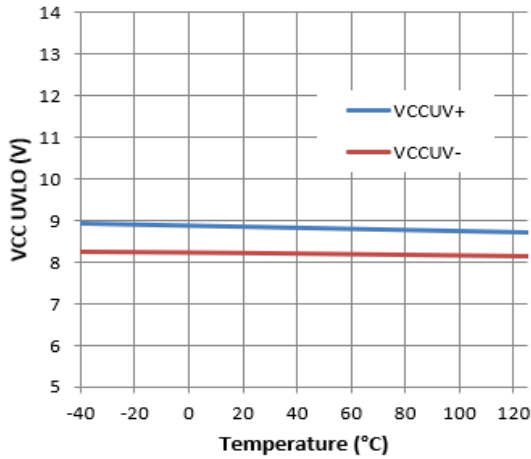

Figure 25. VCC UVLO vs. Temperature

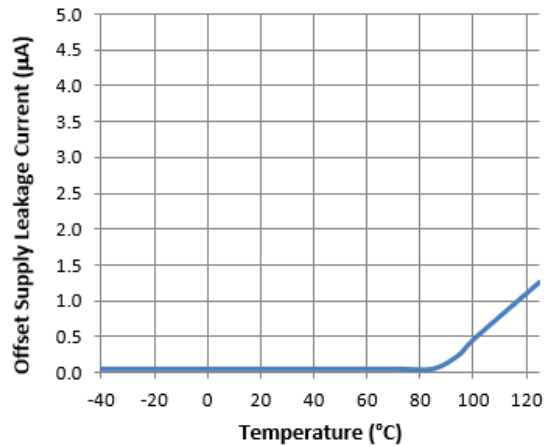
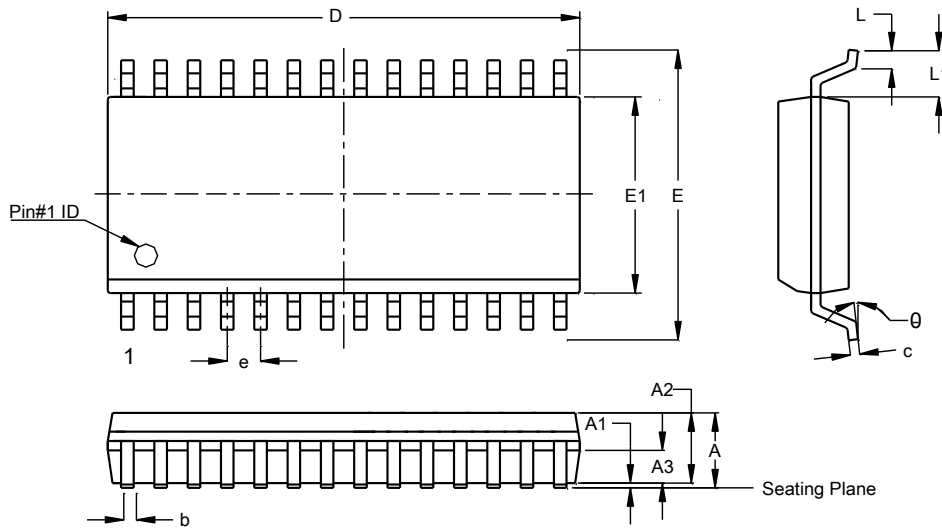

Figure 26. Offset Supply Leakage Current vs. Temperature

Package Outline Dimensions

Please see <http://www.diodes.com/package-outlines.html> for the latest version.

SO-28 (Type TH)



| SO-28 (Type TH) | | | |
|-----------------------------|----------|-------|-------|
| Dim | Min | Max | Typ |
| A | -- | 2.65 | -- |
| A1 | 0.10 | 0.30 | -- |
| A2 | 2.25 | 2.35 | 2.30 |
| A3 | 0.97 | 1.07 | 1.02 |
| b | 0.39 | 0.48 | -- |
| c | 0.25 | 0.31 | -- |
| D | 17.80 | 18.20 | 18.00 |
| E | 10.10 | 10.50 | 10.30 |
| E1 | 7.30 | 7.70 | 7.50 |
| e | 1.27 BSC | | |
| L | 0.70 | 1.00 | -- |
| L1 | 1.40 BSC | | |
| θ | 0° | 8° | -- |
| All Dimensions in mm | | | |

Suggested Pad Layout

Please see <http://www.diodes.com/package-outlines.html> for the latest version.

SO-28 (Type TH)

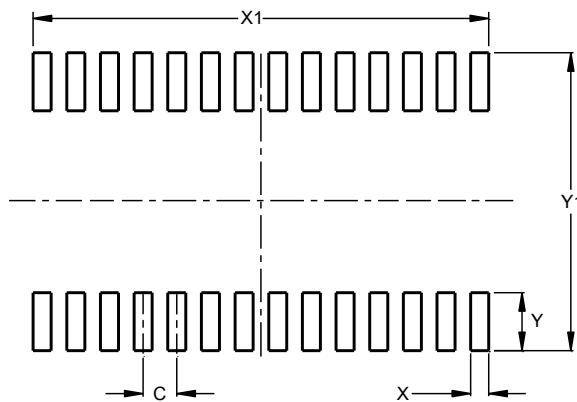

| Dimensions | Value (in mm) |
|------------|---------------|
| C | 1.270 |
| X | 0.680 |
| X1 | 17.190 |
| Y | 2.200 |
| Y1 | 11.300 |

Note: For high voltage applications, the appropriate industry sector guidelines should be considered with regards to creepage and clearance distances between device Terminals and PCB tracking.

IMPORTANT NOTICE

DIODES INCORPORATED MAKES NO WARRANTY OF ANY KIND, EXPRESS OR IMPLIED, WITH REGARDS TO THIS DOCUMENT, INCLUDING, BUT NOT LIMITED TO, THE IMPLIED WARRANTIES OF MERCHANTABILITY AND FITNESS FOR A PARTICULAR PURPOSE (AND THEIR EQUIVALENTS UNDER THE LAWS OF ANY JURISDICTION).

Diodes Incorporated and its subsidiaries reserve the right to make modifications, enhancements, improvements, corrections or other changes without further notice to this document and any product described herein. Diodes Incorporated does not assume any liability arising out of the application or use of this document or any product described herein; neither does Diodes Incorporated convey any license under its patent or trademark rights, nor the rights of others. Any Customer or user of this document or products described herein in such applications shall assume all risks of such use and will agree to hold Diodes Incorporated and all the companies whose products are represented on Diodes Incorporated website, harmless against all damages.

Diodes Incorporated does not warrant or accept any liability whatsoever in respect of any products purchased through unauthorized sales channel. Should Customers purchase or use Diodes Incorporated products for any unintended or unauthorized application, Customers shall indemnify and hold Diodes Incorporated and its representatives harmless against all claims, damages, expenses, and attorney fees arising out of, directly or indirectly, any claim of personal injury or death associated with such unintended or unauthorized application.

Products described herein may be covered by one or more United States, international or foreign patents pending. Product names and markings noted herein may also be covered by one or more United States, international or foreign trademarks.

This document is written in English but may be translated into multiple languages for reference. Only the English version of this document is the final and determinative format released by Diodes Incorporated.

LIFE SUPPORT

Diodes Incorporated products are specifically not authorized for use as critical components in life support devices or systems without the express written approval of the Chief Executive Officer of Diodes Incorporated. As used herein:

A. Life support devices or systems are devices or systems which:

1. are intended to implant into the body, or
2. support or sustain life and whose failure to perform when properly used in accordance with instructions for use provided in the labeling can be reasonably expected to result in significant injury to the user.

B. A critical component is any component in a life support device or system whose failure to perform can be reasonably expected to cause the failure of the life support device or to affect its safety or effectiveness.

Customers represent that they have all necessary expertise in the safety and regulatory ramifications of their life support devices or systems, and acknowledge and agree that they are solely responsible for all legal, regulatory and safety-related requirements concerning their products and any use of Diodes Incorporated products in such safety-critical, life support devices or systems, notwithstanding any devices- or systems-related information or support that may be provided by Diodes Incorporated. Further, Customers must fully indemnify Diodes Incorporated and its representatives against any damages arising out of the use of Diodes Incorporated products in such safety-critical, life support devices or systems.

Copyright © 2018, Diodes Incorporated

www.diodes.com

X-ON Electronics

Largest Supplier of Electrical and Electronic Components

Click to view similar products for [Gate Drivers](#) category:

Click to view products by [Diodes Incorporated](#) manufacturer:

Other Similar products are found below :

[00028](#) [00053P0231](#) [8967380000](#) [56956](#) [CR7E-30DB-3.96E\(72\)](#) [57.404.7355.5](#) [LT4936](#) [57.904.0755.0](#) [5801-0903](#) [5803-0901](#) [5811-0902](#)
[5813-0901](#) [58410](#) [00576P0030](#) [00581P0070](#) [5882900001](#) [00103P0020](#) [00600P0005](#) [00-9050-LRPP](#) [00-9090-RDPP](#) [5951900000](#) [01-](#)
[1003W-10/32-15](#) [LTI LA6E-1S-WH-RC-FN12VXCR1](#) [0131700000](#) [00-2240](#) [LTP70N06](#) [LVP640](#) [0158-624-00](#) [5J0-1000LG-SIL](#) [020017-13](#)
[LY1D-2-5S-AC120](#) [LY2-0-US-AC120](#) [LY2-US-AC240](#) [LY3-UA-DC24](#) [00-5150](#) [00576P0020](#) [00600P0010](#) [LZNQ2M-US-DC5](#) [LZNQ2-](#)
[US-DC12](#) [LZP40N10](#) [00-8196-RDPP](#) [00-8274-RDPP](#) [00-8275-RDNP](#) [00-8609-RDPP](#) [00-8722-RDPP](#) [00-8728-WHPP](#) [00-8869-RDPP](#) [00-](#)
[9051-RDPP](#) [00-9091-LRPP](#) [00-9291-RDPP](#)