

150-330

TO

150-341



TOWER

CABLE CLIPS

TOWER

CABLE CLIPS

Robust design in tough plastic. Assembled with hardened steel, zinc plated masonry pins					
PACK CODE 10 Boxes of 100	NOMINAL SIZE mm	CABLE	AVERAGE BOX QUANTITY	QUANTITY PER OUTER CARTON	CABLE SECTION
PARALLEL TWIN White only					
7PT	5.0 x 2.0	Bell Wire	100		
7PM	5.3 x 2.8	Twin Figure ∞	(CMA CODE 2812X)	100	
7SM	6.2 x 4.1	Sheathed Twin 0.5mm ²	(CMA CODE 3192Y)	100	
FLAT TWIN Grey and White					
72C	7.4 x 4.2	Flat Twin 1.0mm ²	(CMA CODE 6192Y)	100	20,000
FLAT TWIN & EARTH Grey or White					
7KF 1.0	8.0 x 4.4	1.0mm ²	(CMA CODE 6242Y)	100	20,000
7KF 1.5	8.3 x 4.6	1.5mm ²		100	20,000
7KF 2.5	9.7 x 5.4	2.5mm ²		100	20,000
7KF 4.0	12.0 x 6.5	4.0mm ²		100	20,000
7KF 6.0	13.8 x 7.3	6.0mm ²		100	20,000
7KF 10.0	17.4 x 8.8	10.0mm ²		100	10,000
7KF 16.0	20.3 x 10.1	16.0mm ²		50	5,000
7DKF 1.0	15.4 x 4.4	1.0mm ²	(CMA CODE 6242Y)	100	
7DKF 1.5	16.6 x 4.6	1.5mm ²		100	
7DKF 2.5	19.4 x 5.4	2.5mm ²		100	
THREE CORE & EARTH Grey or White					
73C&E	10.5 x 4.4	1.0 & 1.5mm ²	(CMA CODE 6243Y)	100	
ROUND White or Black					
7RC2 ³ / ₄	2.75			100	
7RC3 ¹ / ₂	3.5			100	
7RC4	4.0			100	
7RC5	5.0			100	
7RC6	6.0			100	
7RC7	7.0	Round – Circular		100	
7RC8	8.0			100	
8RC9	9.0			100	
7RC10	10.00			100	
7RC11	11.0			100	
7RC12	12.0			100	
7RC14	14.00			50	
7RC16	16.0			50	
PIN PLUG					
7PP	FOR FIXING CABLE CLIPS WHEN WALL IS TOO HARD EVEN FOR TOWER MASONRY PINS				



SINGLE

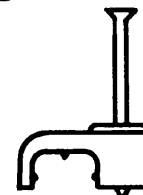

DOUBLE

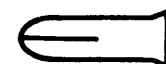
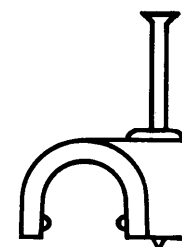
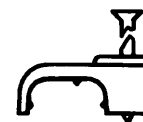
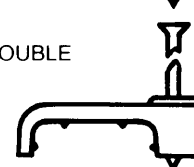

THE PROFESSIONAL'S CHOICE!

TOWER PLASTIC CABLE CLIPS are designed and manufactured from high quality materials. The tough plastic material has been specially selected to suit the requirement according to application, style and size of clip.

The hardened steel pins, are pre-assembled into the clips for maximum utility, being made from a high carbon steel — critically heat-treated, then bright zinc electroplated.

For small bell-wire type cables the PT, PM and SM clips cover most requirements.

The 'FLAT' clip range originated by TOWER for the

CMA TWIN & EARTH cables, have virtually become 'standard' with the trade.

For ROUND cables, TOWER clips are available to accommodate a wide series of cable diameters.

ALL TOWER plastic clips with pre-assembled hardened and plated steel nails provide a professional and low cost fixing.

- FUNCTIONAL AND NEAT DESIGN
- HIGH QUALITY
- FAST FIXING — LOW IN-PLACE-COSTS
- THE PROFESSIONALS CHOICE

M.I. CABLE CLIPS For use with Mineral Insulated Cables

CODE No.	CABLE		SECTION
	Bare	PVC Covered	
7M16	2L1, 2L1.5, 3L1, 3L1.5, 4L1		ROUND Orange
7M17	2L2.5, 4L1.5	2L1, 2L1.5, 3L1	
7M18	2L4, 7L1	2L2.5, 3L1.5, 4L1	
7M19	7L1.5	2L4, 4L1.5, 7L1, 7L1.5	

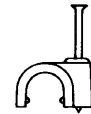

TR CABLE CLIPS For use with Coaxial Cables

CODE No.	Round — Circular	Nominal Size		SECTION
TRC5		5.0mm		ROUND Brown
TRC6		6.0mm		
TRC7		7.0mm		

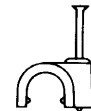

TOWER SINGLE BLOW

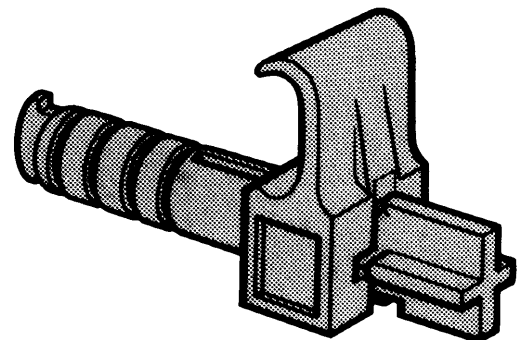

The Tower Single Blow Clip design is a simple one piece operation giving a labour cost saving and a quick easy method of installation into metal, concrete and brickwork for fixing both cable and pipe.

Tower Single Blow Clips are recommended for the installation of central heating pipes by the one operation thus avoiding the use of a clip, screw and plug giving labour cost saving.

The range of clips are supplied to cover diameters from 6mm to 18mm.

TOWER SINGLE BLOW CLIPS White or Black

CODE NO.	NORMAL DIAMETER	PER PACK OF 100
72U1	Round 6–8mm	6.50
72U2	Round 9–13mm	6.50
72U3	Round 14–18mm	6.50

TOWER SINGLE BLOW FLAT CABLE CLIPS White or Grey

CODE No.	NORMAL DIAMETER	PER PACK OF 100
72U4	Flat Twin & Earth 2.5mm ²	6.50

X-ON Electronics

Largest Supplier of Electrical and Electronic Components

Click to view similar products for [Tower](#) manufacturer:

Other Similar products are found below :

[70CWRC8](#)