

Kondensatoren für erhöhte Anforderungen

Capacitors for stringent requirements

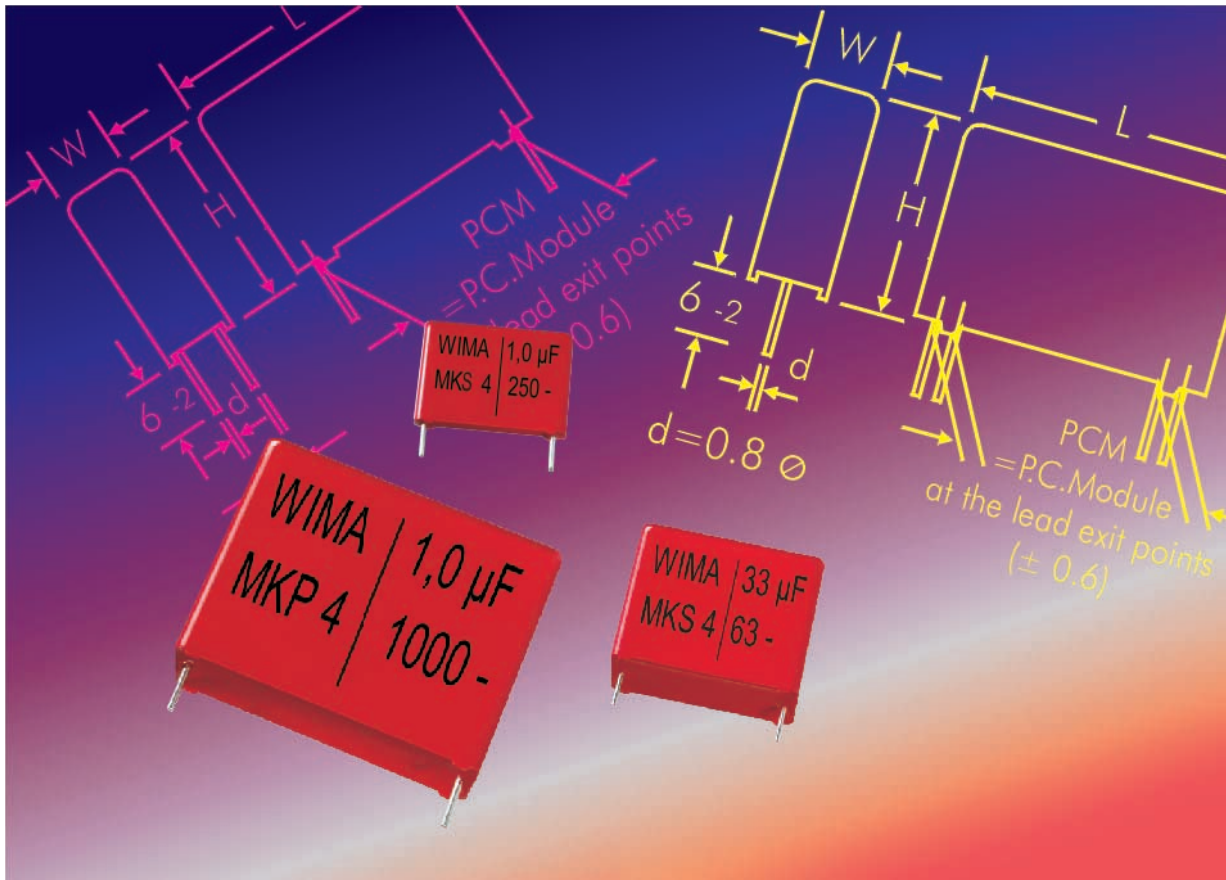

WIMA Kondensatoren für erhöhte Anforderungen umfassen ein breites Kapazitäts- und Spannungsspektrum und stehen als Polyester-, Polypropylen- oder Mischdielektrikum-Ausführungen in metallisierter oder Film/Folien-Bauweise zur Verfügung.

Bei metallisierten Kondensatoren (Aufbau siehe Seite 49) wird eine dünne Metallschicht als Elektrode auf eine Kunststoffolie aufgedampft. Somit können Kondensatoren mit einem sehr günstigen Kapazitäts/Volumen-Verhältnis hergestellt werden. Den höchsten C-Wert erreicht der WIMA MKS 4 mit 100 $\mu\text{F}/63\text{ V}$. Eine weitere spezifische Eigenschaft metallisierter Kondensatoren ist die hervorragende Selbstheilfähigkeit. Im Bereich eines elektrischen Durchschlages verdampft die Metallschicht und die betroffene Stelle wird isoliert. Dadurch bleibt der Kondensator voll funktionsfähig.

Beim Film/Folien-Aufbau wird die Elektrode nicht aufgedampft sondern als Metallfolie zusammen mit dem Dielektrikum gewickelt. Die so gefertigten Bauelemente besitzen aufgrund des niedrigeren Serienwiderstandes eine hervorragende Impuls- bzw. Strombelastbarkeit sowie einen sehr hohen Isolationswiderstand.

WIMA Kondensatoren für erhöhte Anforderungen stehen im Wertebereich von 100 pF bis 33 μF mit Spannungsreihen bis 2000 V- zur Verfügung. Auf Kundenwunsch können größere Bauformen als Sonderanfertigung in Vierdraht-Ausführung oder mit Anschlußlaschen gefertigt werden.

WIMA capacitors for demanding requirements cover a wide range of capacitances and voltages and are available with polyester, polypropylene or mixed dielectric as metallized or film/foil types of construction.

For metallized capacitors (construction see page 49) a thin metal coating serving as electrode is applied to the plastic film. This method makes it possible to produce capacitors with a very favourable capacitance/volume ratio. The WIMA MKS 4, with 100 $\mu\text{F}/63\text{ VDC}$, offers the highest C-rating in the WIMA range. A further specific characteristic of metallized capacitors is the excellent self-healing ability. In the case of an electric breakdown the applied metal layer evaporates. The affected area is isolated and the capacitor continues to function properly.

In the case of film/foil types, the electrode is not applied as for the metallized capacitors, but is wound with the dielectric as a metal foil. Due to their lower series resistance, the components produced this way have excellent pulse and current carrying capacities, as well as a very high insulation resistance.

WIMA capacitors for stringent requirements are available with values ranging from 100 pF through 33 μF with voltage ratings up to 2000 VDC. In accordance with customer requirements, larger box sizes can be supplied as 4-lead versions. Types with terminating tabs can also be manufactured on request.

WIMA MKS 4

Metallisierte Polyester-Kondensatoren für erhöhte Anforderungen

- Für alle Standardanwendungen in Rastermaßen $\geq 7,5$ mm.
- Großes Kapazitätsspektrum bis 100 μF und Spannungsreihen bis 2000 V-.
- Niedriger ESR.
- Speicherkondensator ohne Lebensdauerbegrenzung selbst bei hohen Temperaturen.
- Gegurtet lieferbar bis einschl. Bauform 15 x 26 x 31,5/RM 27,5.

Technische Angaben

Dielektrikum: Polyäthylenterephthalat-Folie.

Beläge: Aluminium, aufmetallisiert.

Umhüllung: Flammhemmendes Kunststoffgehäuse, UL 94 V-0.

Farbe: Rot. Aufdruck: Schwarz. Epoxidharzverguß: Rot.

Temperaturbereich: -55°C bis $+100^\circ\text{C}$.

Prüfungen: Nach IEC 60384-2 bzw. EN 130400.

Prüfklasse: 55/100/56 nach IEC.

Isolationswerte bei $+20^\circ\text{C}$:

U_N	$U_{\text{meß}}$	$C \leq 0,33 \mu\text{F}$	$0,33 \mu\text{F} < C \leq 33 \mu\text{F}$
50 V-	10 V	$\geq 5 \cdot 10^3 \text{ M}\Omega$ Mittelwert: $3 \cdot 10^4 \text{ M}\Omega$	$\geq 1500 \text{ s (M}\Omega \cdot \mu\text{F)}$ Mittelwert: 4500 s
63 V-	50 V	$\geq 1 \cdot 10^4 \text{ M}\Omega$ Mittelwert: $5 \cdot 10^4 \text{ M}\Omega$	$\geq 3000 \text{ s (M}\Omega \cdot \mu\text{F)}$ Mittelwert: 6000 s
100 V-	100 V	$\geq 1,5 \cdot 10^4 \text{ M}\Omega$ Mittelwert: $5 \cdot 10^4 \text{ M}\Omega$	$\geq 5000 \text{ s (M}\Omega \cdot \mu\text{F)}$ Mittelwert: 15000 s
≥ 250 V-	100 V	$\geq 3 \cdot 10^4 \text{ M}\Omega$ Mittelwert: $1 \cdot 10^5 \text{ M}\Omega$	$\geq 10000 \text{ s (M}\Omega \cdot \mu\text{F)}$ Mittelwert: 40000 s

Nach IEC 60384-2 Grade 1 und EN 130400.

Meßzeit: 1 min.

Kapazitätstoleranzen: $\pm 20\%$, $\pm 10\%$, $\pm 5\%$.

Verlustfaktoren bei $+20^\circ\text{C}$: $\tan \delta$

Gemessen bei	$C \leq 0,1 \mu\text{F}$	$0,1 \mu\text{F} < C \leq 1,0 \mu\text{F}$	$C > 1,0 \mu\text{F}$
1 kHz	$\leq 8 \cdot 10^{-3}$	$\leq 8 \cdot 10^{-3}$	$\leq 10 \cdot 10^{-3}$
10 kHz	$\leq 15 \cdot 10^{-3}$	$\leq 15 \cdot 10^{-3}$	-
100 kHz	$\leq 30 \cdot 10^{-3}$	-	-

Prüfspannung: $1,6 U_N$, 2 s.

Schwingen: 6 h bei 10...2000 Hz und 0,75 mm Auslenkung bzw. 10 g nach IEC 60068-2-6.

Unterdruck: 1 kPa = 10 mbar nach IEC 60068-2-13.

Stoßtest: 4000 Stöße mit 390 m/s^2 nach IEC 60068-2-29.

Spannungsderating: Die zulässige Spannung vermindert sich gegenüber der Nennspannung bei Gleichspannungsbetrieb ab $+85^\circ\text{C}$, bei Wechselspannungsbetrieb ab $+75^\circ\text{C}$ um 1,25% je 1 K.

Kurven siehe Seite 6.

Impulsbelastung bei vollem Spannungshub:

C-Wert / Capacitance $\mu\text{F}/\mu\text{F}$	Flankensteilheit V/ μs max. Betrieb/Prüfung				Pulse rise time V/ μsec max. operation/test				
	50 VDC	63 VDC	100 VDC	250 VDC	400 VDC	630 VDC	1000 VDC	1500 VDC	2000 VDC
1000 ... 6800	-	-	50/500	60/600	60/600	60/600	70/700	90/900	100/1000
0.01 ... 0.022	-	30/300	30/300	35/350	38/380	40/400	50/500	50/500	60/600
0.033 ... 0.068	-	15/150	15/150	20/200	25/250	32/320	26/260	35/350	40/400
0.1 ... 0.22	10/100	10/100	12/120	15/150	15/150	17/170	20/200	35/350	40/400
0.33 ... 0.68	9/90	9/90	9/90	10/100	10/100	13/130	20/200	20/200	38/380
1.0 ... 2.2	6/60	6/60	5/50	6/60	9/90	13/130	14/140	15/150	-
3.3 ... 6.8	2.5/25	3/30	3/30	6/60	6/60	9/90	-	-	-
10 ... 47	2.5/25	2.5/25	2.5/25	3/30	6/60	-	-	-	-
68 ... 100	2.5/25	2.5/25	2/20	-	-	-	-	-	-

Metallized polyester capacitors for stringent requirements

- For all standard applications in PCM ≥ 7.5 mm.
- Wide capacitance range up to 100 μF and voltage ranges up to 2000 VDC.
- Low ESR.
- Reservoir capacitor with unlimited life expectancy even at high temperatures.
- Available taped and reeled up to and including case size 15 x 26 x 31.5/PCM 27.5.

Technical Data

Dielectric: Polyethylene-terephthalate film.

Capacitor electrodes: Vacuum-deposited aluminium.

Encapsulation: Flame retardent plastic case, UL 94 V-0.

Colour: Red. Marking: Black. Epoxy resin seal: Red.

Temperature range: -55°C to $+100^\circ\text{C}$.

Test specification: In accord. with IEC 60384-2 and EN 130400.

Test category: 55/100/56 in accordance with IEC.

Insulation resistance at $+20^\circ\text{C}$:

U_r	U_{test}	$C \leq 0.33 \mu\text{F}$	$0.33 \mu\text{F} < C \leq 33 \mu\text{F}$
50VDC	10 V	$\geq 5 \times 10^3 \text{ M}\Omega$ Mean value: $3 \times 10^4 \text{ M}\Omega$	$\geq 1500 \text{ sec (M}\Omega \times \mu\text{F)}$ Mean value: 4500 sec
63VDC	50 V	$\geq 1 \times 10^4 \text{ M}\Omega$ Mean value: $5 \times 10^4 \text{ M}\Omega$	$\geq 3000 \text{ sec (M}\Omega \times \mu\text{F)}$ Mean value: 6000 sec
100VDC	100 V	$\geq 1.5 \times 10^4 \text{ M}\Omega$ Mean value: $5 \times 10^4 \text{ M}\Omega$	$\geq 5000 \text{ sec (M}\Omega \times \mu\text{F)}$ Mean value: 15000 sec
≥ 250 VDC	100 V	$\geq 3 \times 10^4 \text{ M}\Omega$ Mean value: $1 \times 10^5 \text{ M}\Omega$	$\geq 10000 \text{ sec (M}\Omega \times \mu\text{F)}$ Mean value: 40000 sec

In accordance with IEC 60384-2 grade 1 and EN 130400.

Measuring time: 1 min.

Capacitance tolerances: $\pm 20\%$, $\pm 10\%$, $\pm 5\%$.

Dissipation factors at $+20^\circ\text{C}$: $\tan \delta$

at f	$C \leq 0.1 \mu\text{F}$	$0.1 \mu\text{F} < C \leq 1.0 \mu\text{F}$	$C > 1.0 \mu\text{F}$
1 kHz	$\leq 8 \times 10^{-3}$	$\leq 8 \times 10^{-3}$	$\leq 10 \times 10^{-3}$
10 kHz	$\leq 15 \times 10^{-3}$	$\leq 15 \times 10^{-3}$	-
100 kHz	$\leq 30 \times 10^{-3}$	-	-

Test voltage: $1,6 U_r$, 2 sec.

Vibration: 6 hours at 10...2000 Hz and 0.75 mm displacement amplitude or 10 g in accordance with IEC 60068-2-6.

Low air density: 1 kPa = 10 mbar in accord. with IEC 60068-2-13.

Bump test: 4000 bumps at 390 m/sec^2 in accord. with IEC 60068-2-29.

Voltage derating: A voltage derating factor of 1.25% per K must be applied from $+85^\circ\text{C}$ for DC voltages and from $+75^\circ\text{C}$ for AC voltages.

Graphs see page 6.

Maximum pulse rise time for pulses equal to the rated voltage:

WIMA MKS 4

Werteübersicht / General Data

Kapazität Capacitance	50 VDC/30 VAC*				63 VDC/40 VAC*				100 VDC/63 VAC*				250 VDC/160 VAC*				400 VDC/200 VAC*			
	W	H	L	PCM**	W	H	L	PCM**	W	H	L	PCM**	W	H	L	PCM**	W	H	L	PCM**
1000 pF									2.5	7	10	7.5	2.5	7	10	7.5	2.5	7	10	7.5
1500 "									2.5	7	10	7.5	2.5	7	10	7.5	2.5	7	10	7.5
2200 "									2.5	7	10	7.5	2.5	7	10	7.5	2.5	7	10	7.5
3300 "									2.5	7	10	7.5	2.5	7	10	7.5	2.5	7	10	7.5
4700 "									2.5	7	10	7.5	2.5	7	10	7.5	2.5	7	10	7.5
6800 "									2.5	7	10	7.5	2.5	7	10	7.5	3	8.5	10	7.5
0.01 µF					2.5	7	10	7.5	2.5	7	10	7.5	2.5	7	10	7.5*	3	8.5	10	7.5*
0.015 "					2.5	7	10	7.5	2.5	7	10	7.5	2.5	7	10	7.5*	4	9	13	10*
0.022 "					2.5	7	10	7.5	2.5	7	10	7.5	2.5	7	10	7.5*	4	9	13	10*
0.033 "					2.5	7	10	7.5	2.5	7	10	7.5	3	8.5	10	7.5*	4	9	13	10*
0.047 "					2.5	7	10	7.5	2.5	7	10	7.5	3	8.5	10	7.5*	4	9	13	10*
0.068 "					2.5	7	10	7.5	2.5	7	10	7.5	3	8.5	10	7.5*	4	9	13	10*
0.1 µF	2.5	7	10	7.5	2.5	7	10	7.5	3	8.5	10	7.5*	4	9	13	10*	5	10.5	10.3	7.5*
0.15 "	2.5	7	10	7.5	2.5	7	10	7.5	3	8.5	10	7.5*	4	9	13	10*	5	10.5	10.3	7.5*
0.22 "	3	8.5	10	7.5	3	8.5	10	7.5*	4	9	10	7.5*	4	9.5	13	10*	5	10.5	10.3	7.5*
0.33 "	4	9	10	7.5	4	9	10	7.5*	4	9	13	10*	5	11	13	10*	7	14	18	15
0.47 "	4.5	9.5	10.3	7.5	4	9	13	10*	4.5	9.5	10.3	7.5*	5.7	12.5	10.3	7.5*	6	12.5	13	10*
0.68 "	5	10.5	10.3	7.5	4.5	9.5	10.3	7.5*	4.5	9.5	10.3	7.5*	6	12.5	13	10*	6	12.5	18	15
1.0 µF	4.5	9.5	10.3	7.5	5	10.5	10.3	7.5*	5	10.5	10.3	7.5*	7	14	18	15	9	16	18	15*
1.5 "	5	10.5	10.3	7.5	5	11	13	10*	6	12.5	13	10*	7	14	18	15	7	16.5	26.5	22.5
2.2 "	5.7	12.5	10.3	7.5	5	11	13	10*	7	14	18	15	7	16.5	26.5	22.5	13	24	31.5	27.5
3.3 "	8.5	12.5	10.3	7.5	6	12.5	13	10*	8	15	18	15	10.5	19	26.5	22.5	15	26	31.5	27.5
4.7 "	8.5	12.5	10.3	7.5	6	12.5	13	10*	7	16.5	26.5	22.5	11	21	26.5	22.5	17	34.5	31.5	27.5
6.8 "	8.5	12.5	10.3	7.5	7	14	18	15*	7	14	18	15	10.5	19	26.5	22.5	7	16.5	26.5	22.5*
10 µF	9	16	18	15	7	14	18	15*	11	21	26.5	22.5	13	24	31.5	27.5	11	21	26.5	22.5
15 "	11	21	26.5	22.5	8	15	18	15*	13	24	31.5	27.5	15	26	31.5	27.5	15	26	31.5	27.5
22 "	11	21	31.5	27.5	13	24	31.5	27.5	15	26	31.5	27.5	17	29	31.5	27.5	20	39.5	41.5	37.5
33 "	13	24	31.5	27.5	15	26	31.5	27.5	17	29	31.5	27.5	20	39.5	41.5	37.5	20	39.5	41.5	37.5
47 "	15	26	31.5	27.5	17	34.5	31.5	27.5	20	39.5	41.5	37.5	24	45.5	41.5	37.5	24	45.5	41.5	37.5
68 "	20	39.5	31.5	27.5	20	39.5	31.5	27.5	24	45.5	41.5	37.5	24	45.5	41.5	37.5	24	45.5	41.5	37.5
100 µF	24	45.5	41.5	37.5	24	45.5	41.5	37.5												

* Wechselspannungen: $f = 50 \text{ Hz}$; $1,4 \cdot U_{\text{eff}} \sim + U - \leq U_N$
 * AC voltage: $f = 50 \text{ Hz}$; $1,4 \times U_{\text{rms}} + U_{\text{DC}} \leq U_r$
 ** PCM = Printed circuit module = Rastermaß / lead spacing.

Neue Werte und Bauform. / New values and box size.

* Bei Bestellung bitte das gewünschte Rastermaß angeben!
 Wenn keine Angaben erfolgen, wird grundsätzlich das kleinere RM geliefert.

* On ordering please state the required PCM (lead spacing)!
 If not specified, smaller PCM will be booked.

Gegurtete Ausführung siehe Seite 93.
 Taped version see page 93.

Alle Maße in mm. / Dims. in mm.

ø d	PCM	W
0.5	7.5	≤ 3
0.7	7.5	≥ 4
0.7	10	
0.8	15 - 22.5	
0.8	27.5	≤ 15
1.0	27.5	> 15
1.0	37.5	

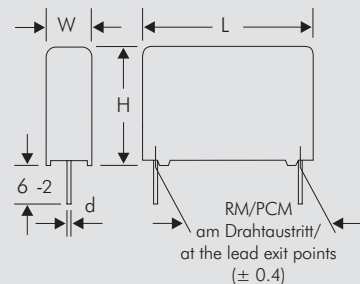

Abweichungen und Konstruktionsänderungen vorbehalten.
 Rights reserved to amend design data without prior notification.

Werteübersicht / General Data

Kapazität Capacitance	630 VDC/300 VAC *				1000 VDC/400 VAC *				1500 VDC/400 VAC *				2000 VDC/400 VAC *			
	W	H	L	PCM**	W	H	L	PCM**	W	H	L	PCM**	W	H	L	PCM**
1000 pF	2.5	7	10	7.5**	4	9	13	10	4	9	13	10	4	9	13	10
1500 "	2.5	7	10	7.5**	4	9	13	10	4	9	13	10	4	9	13	10
2200 "	2.5	7	10	7.5**	4	9	13	10	4	9	13	10	5	11	13	10
3300 "	2.5	7	10	7.5**	4	9	13	10	4	9	13	10	6	12.5	13	10
4700 "	2.5	7	10	7.5**	4	9	13	10	4	9.5	13	10	5	11	18	15
6800 "	3	8.5	10	7.5**	4	9	13	10	5	11	13	10	6	12.5	18	15
0.01 µF	3	8.5	10	7.5**	5	11	13	10	6	12.5	13	10	7	14	18	15
	4	9	13	10*												
0.015 "	4	9	10	7.5**	6	12.5	13	10	6	12.5	18	15	6	15	26.5	22.5
	4	9	13	10*												
0.022 "	4.5	9.5	10.3	7.5**	5	11	18	15	7	14	18	15	7	16.5	26.5	22.5
	4	9	13	10*												
0.033 "	5	10.5	10.3	7.5**	6	12.5	18	15	8	15	18	15	10.5	19	26.5	22.5
	5	11	13	10*												
0.047 "	5.7	12.5	10.3	7.5**	7	14	18	15	7	16.5	26.5	22.5	11	21	26.5	22.5
	6	12.5	13	10*												
0.068 "	5	11	18	15	8	15	18	15	8.5	18.5	26.5	22.5	11	21	31.5	27.5
0.1 µF	6	12.5	18	15	7	16.5	26.5	22.5	10.5	19	26.5	22.5	13	24	31.5	27.5
0.15 "	7	14	18	15	8.5	18.5	26.5	22.5	11	21	31.5	27.5	17	29	31.5	27.5
0.22 "	8	15	18	15	11	21	26.5	22.5	13	24	31.5	27.5	17	29	41.5	37.5
0.33 "	7	16.5	26.5	22.5	11	21	31.5	27.5	17	34.5	31.5	27.5	20	39.5	41.5	37.5
0.47 "	10.5	19	26.5	22.5	15	26	31.5	27.5	20	39.5	31.5	27.5	24	45.5	41.5	37.5
0.68 "	11	21	26.5	22.5	17	29	31.5	27.5	24	45.5	41.5	37.5				
1.0 µF	11	21	31.5	27.5	19	32	41.5	37.5								
1.5 "	15	26	31.5	27.5	20	39.5	41.5	37.5								
2.2 "	17	34.5	31.5	27.5	24	45.5	41.5	37.5								
3.3 "	20	39.5	41.5	37.5												
4.7 "	24	45.5	41.5	37.5												

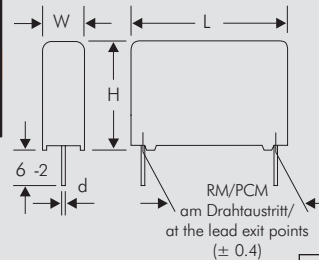

ø d	PCM	W
0.5	7.5	≤ 3
0.7	7.5	≥ 4
0.7	10	
0.8	15 - 22.5	
0.8	27.5	≤ 15
1.0	27.5	> 15
1.0	37.5	

- * Wechselspannungen: $f = 50 \text{ Hz}$; $1,4 \cdot U_{\text{eff}} \sim + U_{-} \leq U_N$
- * AC voltage: $f = 50 \text{ Hz}$; $1,4 \times U_{\text{rms}} + U_{\text{DC}} \leq U_r$
- Neue Werte / New values.
- ** PCM = Printed circuit module = Rastermaß / lead spacing.
- * Bei Bestellung bitte das gewünschte Rastermaß angeben!
Wenn keine Angaben erfolgen, wird grundsätzlich das kleinere RM geliefert.
- * On ordering please state the required PCM (lead spacing)!
If not specified, smaller PCM will be booked.
- ** Zulässige Nennwechselspannung max. 220 V~
- ** Admissible AC voltage 220 VAC max.

Alle Maße in mm.
Dims. in mm.
Abweichungen und Konstruktionsänderungen vorbehalten.
Rights reserved to amend design data without prior notification.

Wechselspannung in Abhängigkeit von der Frequenz bei 10° C Eigenerwärmung (Richtwerte).
Permissible AC voltages in relation to frequency at 10° C internal temperature rise (general data).

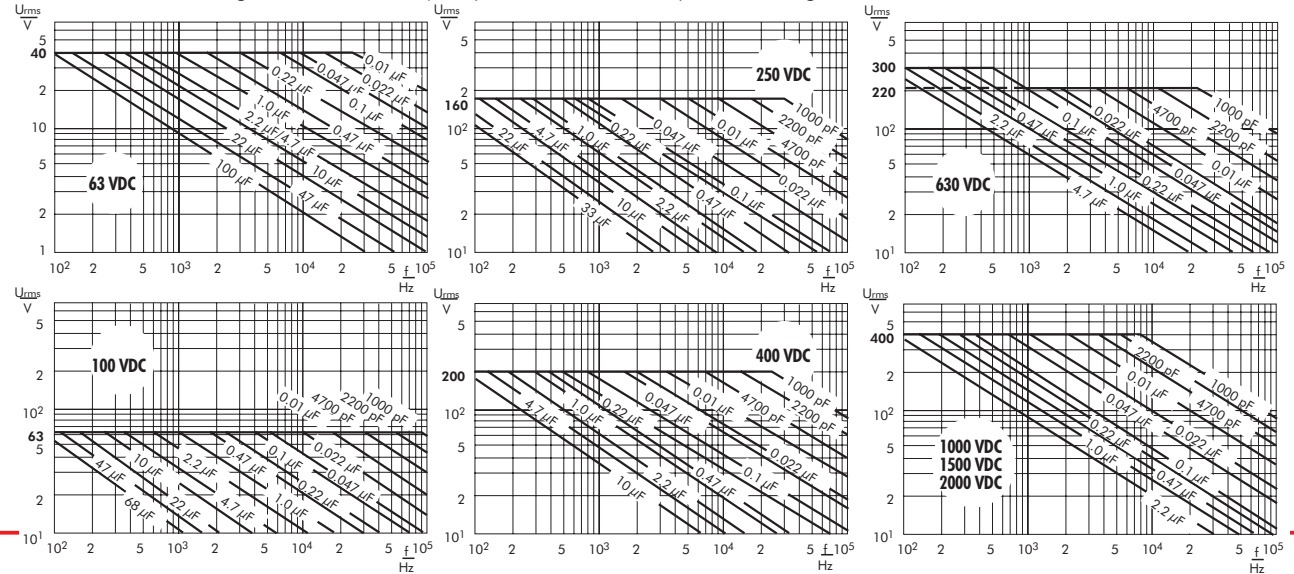

WIMA MKP 4

Metallisierte Polypropylen-Kondensatoren für erhöhte Anforderungen

- **Niedrigster Verlustfaktor.** ■ **Konstant negativer TKc.**
- **Niedrige dielektrische Absorption: geeignet für „sample-and-hold“-Schaltungen.** ■ **Für Anwendungen im Bereich hoher Frequenzen.** ■ **Hohe Kapazitätswerte z.B. für Lautsprecherweichen.** ■ **Gegurtet lieferbar bis einschl. Bauform 15 x 26 x 31,5/RM 27,5.**

Technische Angaben

Dielektrikum: Polypropylen-Folie.

Beläge: Aluminium, aufmetallisiert.

Umhüllung: Flammhemmendes Kunststoffgehäuse, UL 94 V-0.
Farbe: Rot. Aufdruck: Schwarz. Epoxidharzverguß: Rot.

Temperaturbereich: -55° C bis +100° C.

Prüfungen: Nach IEC 60384-16 bzw. EN 131 200.

Prüfklasse: 55/100/56 nach IEC.

Isolationswerte bei +20° C:

$C \leq 0,33 \mu\text{F}: \geq 1 \cdot 10^5 \text{ M}\Omega$ (Mittelwert: $5 \cdot 10^5 \text{ M}\Omega$).

$C > 0,33 \mu\text{F}: \geq 30\,000 \text{ s (M}\Omega \cdot \mu\text{F)}$ (Mittelwert: 100 000 s).

Nach IEC 60384-16 und EN 131 200.

Meßspannung: 100 V/1 min.

Kapazitätstoleranzen: $\pm 20\%$, $\pm 10\%$, $\pm 5\%$.

Impulsbelastung:

C-Wert $\mu\text{F}/\mu\text{F}$	Flankensteilheit V/ μs max. Betrieb/Prüfung				
	100 V-	250 V-	400 V-	630 V-	1000 V-
1000 ... 6800	55/550	55/550	55/550	60/600	65/650
0,01 ... 0,022	45/450	45/450	45/450	50/500	55/550
0,033 ... 0,068	25/250	25/250	30/300	35/350	40/400
0,1 ... 0,22	15/150	15/150	17/170	20/200	22/220
0,33 ... 0,68	10/100	10/100	13/130	15/150	18/180
1,0 ... 2,2	7,5/75	7,5/75	9/90	11/110	13/130
3,3 ... 4,7	6/60	6/60	8/80	9/90	-
6,8 ... 10	4/40	5/50	6/60	8,5/85	-
15 ... 22	3,5/35	5/50	-	-	-

bei vollem Spannungshub.

Verlustfaktoren bei +20° C: $\tan \delta$

Gemessen bei	$C \leq 0,1 \mu\text{F}$	$0,1 \mu\text{F} < C \leq 1,0 \mu\text{F}$	$C > 1,0 \mu\text{F}$
1 kHz	$\leq 0,4 \cdot 10^{-3}$	$\leq 0,5 \cdot 10^{-3}$	$\leq 1,0 \cdot 10^{-3}$
10 kHz	$\leq 0,6 \cdot 10^{-3}$	$\leq 0,8 \cdot 10^{-3}$	-
100 kHz	$\leq 2,5 \cdot 10^{-3}$	-	-

Prüfspannung: $1,6 U_N$, 2 s.

Schwingen: 6 h bei 10...2000 Hz und 0,75 mm Auslenkung bzw. 10 g nach IEC 60068-2-6.

Unterdruck: 1 kPa = 10 mbar nach IEC 60068-2-13.

Stoßtest: 4000 Stöße mit 390 m/s² nach IEC 60068-2-29.

Dielektrische Absorption: 0,05 %.

Spannungsderating: Die zulässige Spannung vermindert sich gegenüber der Nennspannung bei Gleichspannungsbetrieb ab +85° C, bei Wechselspannungsbetrieb ab +75° C um 1,35% je 1 K.

Kurven siehe Seite 7.

Metallized polypropylene capacitors for stringent requirements

- **Extremely low dissipation factor.** ■ **Constantly negative TKc.** ■ **Low dielectric absorption: suitable for „sample and hold“ circuits.** ■ **Suitable for applications in high frequencies.** ■ **High capacitance values e.g. for frequency dividing in loudspeakers.** ■ **Available taped and reeled up to and incl. case size 15x26x31.5/PCM 27.5.**

Technical Data

Dielectric: Polypropylene film.

Capacitor electrodes: Vacuum-deposited aluminium.

Encapsulation: Flame retardent plastic case, UL 94 V-0.
Colour: Red. Marking: Black. Epoxy resin seal: Red.

Temperature range: -55° C to +100° C.

Test specification: In accordance with IEC 60384-16 and EN 131 200.

Test category: 55/100/56 in accordance with IEC.

Insulation resistance at +20° C:

$C \leq 0,33 \mu\text{F}: \geq 1 \times 10^5 \text{ M}\Omega$ (mean value: $5 \times 10^5 \text{ M}\Omega$).

$C > 0,33 \mu\text{F}: \geq 30\,000 \text{ sec (M}\Omega \times \mu\text{F)}$ (mean value: 100 000 sec).

In accordance with IEC 60384-16 and EN 131 200.

Measuring voltage: 100 V/1 min.

Capacitance tolerances: $\pm 20\%$, $\pm 10\%$, $\pm 5\%$.

Maximum pulse rise time:

Capacitance $\mu\text{F}/\mu\text{F}$	Pulse rise time V/ μsec max. operation/test				
	100 VDC	250 VDC	400 VDC	630 VDC	1000 VDC
1000 ... 6800	55/550	55/550	55/550	60/600	65/650
0.01 ... 0.022	45/450	45/450	45/450	50/500	55/550
0.033 ... 0.068	25/250	25/250	30/300	35/350	40/400
0.1 ... 0.22	15/150	15/150	17/170	20/200	22/220
0.33 ... 0.68	10/100	10/100	13/130	15/150	18/180
1.0 ... 2.2	7.5/75	7.5/75	9/90	11/110	13/130
3.3 ... 4.7	6/60	6/60	8/80	9/90	-
6.8 ... 10	4/40	5/50	6/60	8.5/85	-
15 ... 22	3.5/35	5/50	-	-	-

for pulses equal to the rated voltage.

Dissipation factors at +20° C: $\tan \delta$

at f	$C \leq 0,1 \mu\text{F}$	$0,1 \mu\text{F} < C \leq 1,0 \mu\text{F}$	$C > 1,0 \mu\text{F}$
1 kHz	$\leq 0,4 \times 10^{-3}$	$\leq 0,5 \times 10^{-3}$	$\leq 1,0 \times 10^{-3}$
10 kHz	$\leq 0,6 \times 10^{-3}$	$\leq 0,8 \times 10^{-3}$	-
100 kHz	$\leq 2,5 \times 10^{-3}$	-	-

Test voltage: $1,6 U_r$, 2 sec.

Vibration: 6 hours at 10...2000 Hz and 0.75 mm displacement amplitude or 10 g in accordance with IEC 60068-2-6.

Low air density: 1 kPa = 10 mbar in accordance with IEC 60068-2-13.

Bump test: 4000 bumps at 390 m/sec² in accord. with IEC 60068-2-29.

Dielectric absorption: 0.05 %.

Voltage derating: A voltage derating factor of 1.35% per K must be applied from +85° C for DC voltages and from +75° C for AC voltages.

Graphs see page 7.

WIMA MKP 4

Werteübersicht / General Data

Kapazität Capacitance	100 VDC/63 VAC *				250 VDC/160 VAC *				400 VDC/220 VAC *				630 VDC/280 VAC *				1000 VDC/400 VAC *				
	W	H	L	PCM**	W	H	L	PCM**	W	H	L	PCM**	W	H	L	PCM**	W	H	L	PCM**	
1000 pF	2.5	7	10	7.5	2.5	7	10	7.5	2.5	7	10	7.5	2.5	7	10	7.5	2.5	7	10	7.5	
1500 "	2.5	7	10	7.5	2.5	7	10	7.5	2.5	7	10	7.5	2.5	7	10	7.5	2.5	7	10	7.5	
2200 "	2.5	7	10	7.5	2.5	7	10	7.5	2.5	7	10	7.5	2.5	7	10	7.5	3	8.5	10	7.5	
3300 "	2.5	7	10	7.5	2.5	7	10	7.5	2.5	7	10	7.5	3	8.5	10	7.5	4	9	10	7.5	
4700 "	2.5	7	10	7.5	2.5	7	10	7.5	2.5	7	10	7.5	3	8.5	10	7.5	4.5	9.5	10.3	7.5*	
6800 "	2.5	7	10	7.5	2.5	7	10	7.5	2.5	7	10	7.5	3	8.5	10	7.5	4	9	13	10*	
																	5	10.5	10.3	7.5*	
																	4	9	13	10*	
0.01 µF	2.5	7	10	7.5	2.5	7	10	7.5	2.5	7	10	7.5	3	8.5	10	7.5*	5.7	12.5	10.3	7.5*	
0.015 "	2.5	7	10	7.5	2.5	7	10	7.5	3	8.5	10	7.5	4	9	13	10*	5	11	13	10*	
0.022 "	2.5	7	10	7.5	2.5	7	10	7.5	3	8.5	10	7.5	4	9	13	10*	5	11	13	10	
0.033 "	2.5	7	10	7.5	2.5	7	10	7.5	4	9	10	7.5	4	9	13	10*	5	11	18	15	
0.047 "	3	8.5	10	7.5	3	8.5	10	7.5	4	9	10	7.5	4.5	9.5	10.3	7.5*	5	11	18	15	
0.068 "	4	9	10	7.5	4	9	10	7.5*	4.5	9.5	10.3	7.5*	5	10.5	10.3	7.5*	6	12.5	18	15	
									4	9	13	10*	4	9.5	13	10*	4	9.5	13	10*	
									4	9	13	10*	5	10.5	10.3	7.5*	5	11	13	10*	
									5.7	12.5	10.3	7.5*	6	12.5	18	15	8	15	18	15	
									5	11	13	10*	5	11	13	10*	6	12.5	18	15	
0.1 µF	4.5	9.5	10.3	7.5	4.5	9.5	10.3	7.5*	5	11	18	15	7	14	18	15	7	16.5	26.5	22.5	
					4	9.5	13	10*	4	9.5	13	10*	7	14	18	15	7	16.5	26.5	22.5	
0.15 "	5	10.5	10.3	7.5	5	10.5	10.3	7.5*	6	12.5	18	15	8	15	18	15	8.5	18.5	26.5	22.5	
					5	11	13	10*	5	11	13	10*	6	12.5	18	15	8.5	18.5	26.5	22.5	
0.22 "	5	11	18	15	5	11	18	15	7	14	18	15	7	16.5	26.5	22.5	11	21	26.5	22.5	
0.33 "	6	12.5	18	15	6	12.5	18	15	8	15	18	15	8.5	18.5	26.5	22.5	11	21	31.5	27.5	
0.47 "	7	14	18	15	7	14	18	15	7	16.5	26.5	22.5	10.5	19	26.5	22.5	13	24	31.5	27.5	
0.68 "	6	15	26.5	22.5	6	15	26.5	22.5	8.5	18.5	26.5	22.5	11	21	31.5	27.5	17	29	31.5	27.5	
1.0 µF	8.5	18.5	26.5	22.5	8.5	18.5	26.5	22.5	11	21	26.5	22.5	13	24	31.5	27.5	17	29	41.5	37.5	
1.5 "	10.5	19	26.5	22.5	10.5	19	26.5	22.5	11	21	31.5	27.5	17	29	31.5	27.5	20	39.5	41.5	37.5	
2.2 "	11	21	26.5	22.5	11	21	26.5	22.5	15	26	31.5	27.5	17	29	41.5	37.5	24	45.5	41.5	37.5	
3.3 "	13	24	31.5	27.5	13	24	31.5	27.5	17	29	31.5	27.5	19	32	41.5	37.5					
4.7 "	15	26	31.5	27.5	15	26	31.5	27.5	19	32	41.5	37.5	20	39.5	41.5	37.5					
6.8 "	13	24	41.5	37.5	15	26	41.5	37.5	20	39.5	41.5	37.5	24	45.5	41.5	37.5					
10 µF	17	29	41.5	37.5	19	32	41.5	37.5	24	45.5	41.5	37.5									
15 "	19	32	41.5	37.5	20	39.5	41.5	37.5													
22 "	20	39.5	41.5	37.5	24	45.5	41.5	37.5													

* Wechselspannungen: $f \leq 400$ Hz; $1,4 \cdot U_{\text{eff}} \sim + U_- \leq U_N$

* AC voltage: $f \leq 400$ Hz, $1,4 \times U_{\text{rms}} + \text{UDC} \leq U_r$

Neue Werte. / New values.

** PCM = Printed circuit module = Rastermaß. / lead spacing.

* Bei Bestellung bitte das gewünschte Rastermaß angeben!
Wenn keine Angaben erfolgen, wird grundsätzlich das kleinere RM geliefert.

* On ordering please state the required PCM (lead spacing)!
If not specified, smaller PCM will be booked.

Gegurtete Ausführung siehe Seite 93. / Taped version see page 93.

Alle Maße in mm. / Dims. in mm.

Abweichungen und Konstruktionsänderungen vorbehalten.
Rights reserved to amend design data without prior notification.

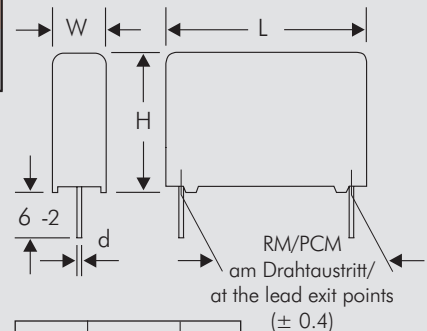

ø d	PCM	W
0.5	7.5	≤ 3
0.7	7.5	≥ 4
0.7	10	
0.8	15 - 22.5	
0.8	27.5	≤ 15
1.0	27.5	> 15
1.0	37.5	

Fortsetzung Seite 56 / Continuation page 56

WIMA MKP 4

Wechselspannung in Abhängigkeit von der Frequenz bei 10° C Eigenerwärmung (Richtwerte).

Permissible AC voltages in relation to frequency at 10° C internal temperature rise (general data).

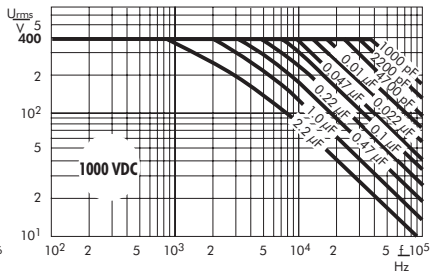
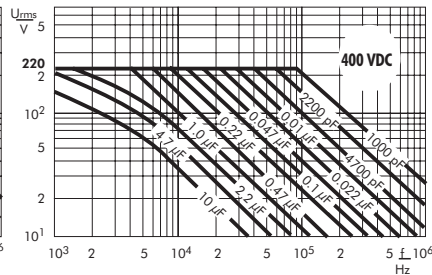
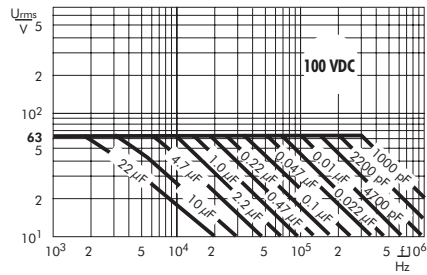
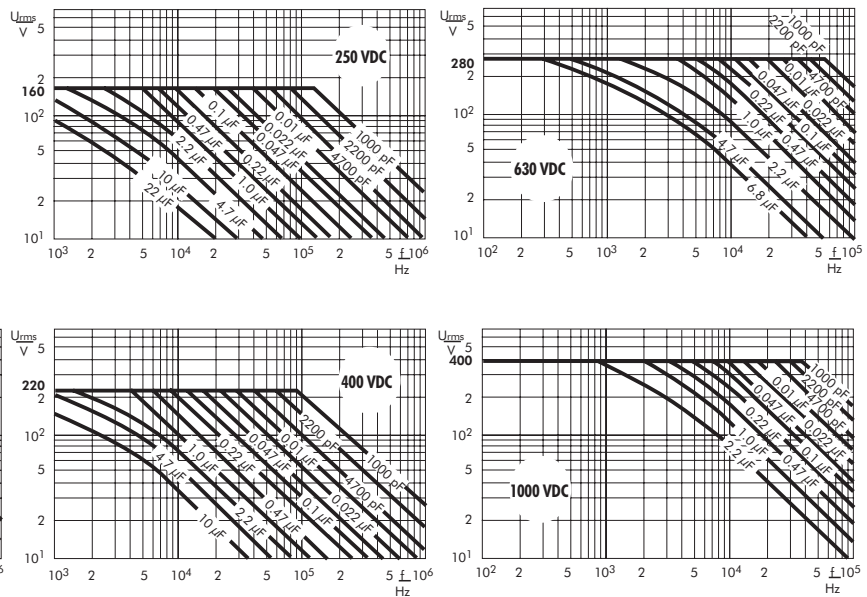

Bestellbeispiele für WIMA Kondensatoren

Im Gegensatz zu anderen Herstellern benutzt WIMA keine speziellen Bestellcodes. In der Regel genügen Angaben zum Kondensatortyp, den elektrischen Werten wie Kapazität, Toleranz und Spannung sowie gegebenenfalls dem Rastermaß und der Gurtungsart.

Nachfolgend einige Bestellbeispiele:

Typ	RM	C-Wert	Gurtung (optional)
SMD 2220		0,1/20/100 V~	BP 330* (BP=blister pack)
MKS 2		0,1/20/ 63 V~	ROLL 18,5*
MKS 4	RM 10*	1,0/10/ 63 V~	REEL 16,5/360*
MP 3-X2	RM 15*	0,1/20/250 V~	

*vergleiche Katalogangaben

Um also beispielsweise einen WIMA MKS 2 (wird nur im Rastermaß 5 mm gefertigt) mit dem C-Wert 0,1 µF in 63 V~, einer Toleranz von 20% und gegurtet in einer Rollenverpackung mit einer Gurthöhe von 18,5 mm zu bestellen genügen die Angaben:

MKS 2 0,1/20/63 ROLL 18,5.

Für Auftrag und Lieferung gelten unsere aktuellen Liefer- und Zahlungsbedingungen.

Example for ordering WIMA capacitors

Unlike other manufacturers WIMA does not use special part numbers. In general, the indication of the type together with the electrical values capacitance, tolerance and voltage are sufficient. PCM and taping mode may be necessary.

Please find below some examples:

Family	PCM	Value	Taping (optional)
SMD 2220		0.1/20/100 VDC	BP 330* (BP=blister pack)
MKS 2		0.1/20/ 63 VDC	ROLL 18.5*
MKS 4	PCM 10*	1.0/10/ 63 VDC	REEL 16.5/360*
MP 3-X2	PCM 15*	0.1/20/250 VAC	

*compare catalogue data

For example, to order a WIMA MKS 2 (which is only available in PCM 5 mm), capacitance 0.1 µF, 63 VDC, tolerance 20%, taped in ROLL packaging, taping height 18.5 mm the following is required:

MKS 2 0.1/20/63 ROLL 18.5.

Orders and deliveries are subject to our actual Terms of Delivery and Payment.

WIMA MKM 4

Metallisierte Kondensatoren mit Mischdielektrikum für erhöhte Anforderungen

■ Nahezu konstanter Kapazitätswert über die Temperatur. ■ Hervorragend geeignet für Applikationen mit großem Anwendungstemperaturbereich, z.B. in der Kfz.-Elektronik. ■ Gegartet lieferbar.

Technische Angaben

Dielektrikum: Misch-Folie.

Beläge: Aluminium, aufmetallisiert.

Umhüllung: Flammhemmendes Kunststoffgehäuse, UL 94 V-0.

Farbe: Rot. Aufdruck: Schwarz. Epoxidharzverguß: Rot.

Temperaturbereich: -55° C bis +100° C.

Prüfklasse: 55/100/56 nach IEC.

Isolationswerte bei +20° C:

$C \leq 0,33 \mu\text{F}: \geq 3 \cdot 10^4 \text{ M}\Omega$ (Mittelwert: $1 \cdot 10^5 \text{ M}\Omega$)

$C > 0,33 \mu\text{F}: \geq 10\,000 \text{ s (M}\Omega \cdot \mu\text{F)}$ (Mittelwert: 40\,000 s)

Meßspannung: 100 V/1 min.

Verlustfaktoren bei +20° C: $\tan \delta$

Gemessen bei	$C \leq 0,1 \mu\text{F}$	$0,1 \mu\text{F} < C \leq 1,0 \mu\text{F}$	$C > 1,0 \mu\text{F}$
1 kHz	$\leq 5 \cdot 10^{-3}$	$\leq 5 \cdot 10^{-3}$	$\leq 5 \cdot 10^{-3}$
10 kHz	$\leq 8 \cdot 10^{-3}$	$\leq 9 \cdot 10^{-3}$	-
100 kHz	$\leq 11 \cdot 10^{-3}$	-	-

Kapazitätstoleranzen: $\pm 20\%$, $\pm 10\%$, $\pm 5\%$.

Temperaturcharakteristik: Siehe Kurve.

Impulsbelastung:

C-Wert μF	Flankensteilheit V/ μs max. Betrieb/Prüfung	
	250 V-	400 V-
0,022 ... 0,068	20/200	25/250
0,1 ... 0,22	15/150	15/150
0,33 ... 0,68	10/100	10/100
1,0 ... 2,2	6/60	9/90
3,3 ... 4,7	6/60	7/70

bei vollem Spannungshub.

Prüfspannung: $1,6 U_N$, 2 s.

Schwingen: 6 h bei 10...2000 Hz und 0,75 mm Auslenkung bzw. 10 g nach IEC 60068-2-6.

Unterdruck: 1 kPa = 10 mbar nach IEC 60068-2-13.

Stoßtest: 4000 Stöße mit 390 m/s² nach IEC 60068-2-29.

Spannungsderating: Die zulässige Spannung vermindert sich gegenüber der Nennspannung bei Gleichspannungsbetrieb ab +85° C, bei Wechselspannungsbetrieb ab +75° C um 1,35% je 1 K.

Kurven siehe Seite 8.

Metallized capacitors with mixed dielectric for stringent requirements

■ Almost linear capacitance temperature coefficient. ■ Ideally suited for applications with wide temperature range, e.g. automotive electronics. ■ Available taped and reeled.

Technical Data

Dielectric: Mixed film.

Capacitor electrodes: Vacuum-deposited aluminium.

Encapsulation: Flame retardent plastic case, UL 94 V-0.

Colour: Red. Marking: Black. Epoxy resin seal: Red.

Temperature range: -55° C to +100° C.

Test category: 55/100/56 in accordance with IEC.

Insulation resistance at +20° C:

$C \leq 0,33 \mu\text{F}: \geq 3 \times 10^4 \text{ M}\Omega$ (mean value: $1 \times 10^5 \text{ M}\Omega$)

$C > 0,33 \mu\text{F}: \geq 10\,000 \text{ sec (M}\Omega \times \mu\text{F)}$ (mean value: 40\,000 sec)

Measuring voltage: 100 V/1 min.

Dissipation factors at +20° C: $\tan \delta$

at f	$C \leq 0,1 \mu\text{F}$	$0,1 \mu\text{F} < C \leq 1,0 \mu\text{F}$	$C > 1,0 \mu\text{F}$
1 kHz	$\leq 5 \times 10^{-3}$	$\leq 5 \times 10^{-3}$	$\leq 5 \times 10^{-3}$
10 kHz	$\leq 8 \times 10^{-3}$	$\leq 9 \times 10^{-3}$	-
100 kHz	$\leq 11 \times 10^{-3}$	-	-

Capacitance tolerances: $\pm 20\%$, $\pm 10\%$, $\pm 5\%$.

Temperature characteristics: See graph.

Maximum pulse rise time:

Capacitance μF	Pulse rise time V/ μsec max. operation/test	
	250 VDC	400 VDC
0.022 ... 0.068	20/200	25/250
0.1 ... 0.22	15/150	15/150
0.33 ... 0.68	10/100	10/100
1.0 ... 2.2	6/60	9/90
3.3 ... 4.7	6/60	7/70

for pulses equal to the rated voltage.

Test voltage: $1,6 U_r$, 2 sec.

Vibration: 6 hours at 10...2000 Hz and 0.75 mm displacement amplitude or 10 g in accordance with IEC 60068-2-6.

Low air density: 1 kPa = 10 mbar in accordance with IEC 60068-2-13.

Bump test: 4000 bumps at 390 m/sec² in accord. with IEC 60068-2-29.

Voltage derating: A voltage derating factor of 1.35% per K must be applied from +85° C for DC voltages and from +75° C for AC voltages.

Graphs see page 8.

Werteübersicht / General Data

Kapazität Capacitance	250 VDC/160 VAC *				400 VDC/200 VAC *			
	W	H	L	PCM**	W	H	L	PCM**
0.022 μ F					4	9	13	10
0.033 "					4	9.5	13	10
0.047 "	4	9	13	10	5	11	13	10
0.068 "	4	9.5	13	10	5	11	18	15
0.1 μ F	5	11	13	10	5	11	18	15
0.15 "	5	11	18	15	6	12.5	18	15
0.22 "	5	11	18	15	7	14	18	15
0.33 "	6	12.5	18	15	6	15	26.5	22.5
0.47 "	7	14	18	15	7	16.5	26.5	22.5
0.68 "	6	15	26.5	22.5	10.5	19	26.5	22.5
1.0 μ F	7	16.5	26.5	22.5	11	21	26.5	22.5
1.5 "	10.5	19	26.5	22.5	13	24	31.5	27.5
2.2 "	11	21	26.5	22.5	15	26	31.5	27.5
3.3 "	13	24	31.5	27.5				
4.7 "	15	26	31.5	27.5				

* Wechselspannungen: $f = 50 \text{ Hz}$; $1,4 \cdot U_{\text{eff}} \sim + U_- \leq U_N$
 AC voltage: $f = 50 \text{ Hz}$; $1,4 \times U_{\text{rms}} + \text{UDC} \leq U_r$

** PCM = Printed circuit module = Rastermaß.
 ** PCM = Printed circuit module = lead spacing.

Gegurtete Ausführung siehe Seite 93.
 Taped version see page 93.

Alle Maße in mm.
 Dims. in mm.

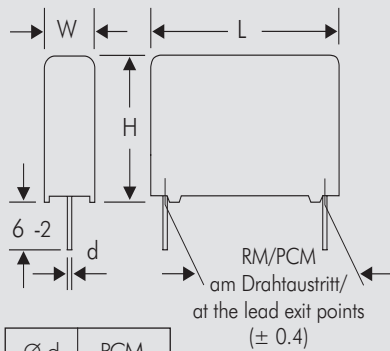

Abweichungen und Konstruktionsänderungen vorbehalten.
 Rights reserved to amend design data without prior notification.

Typical dimensions for taping configuration

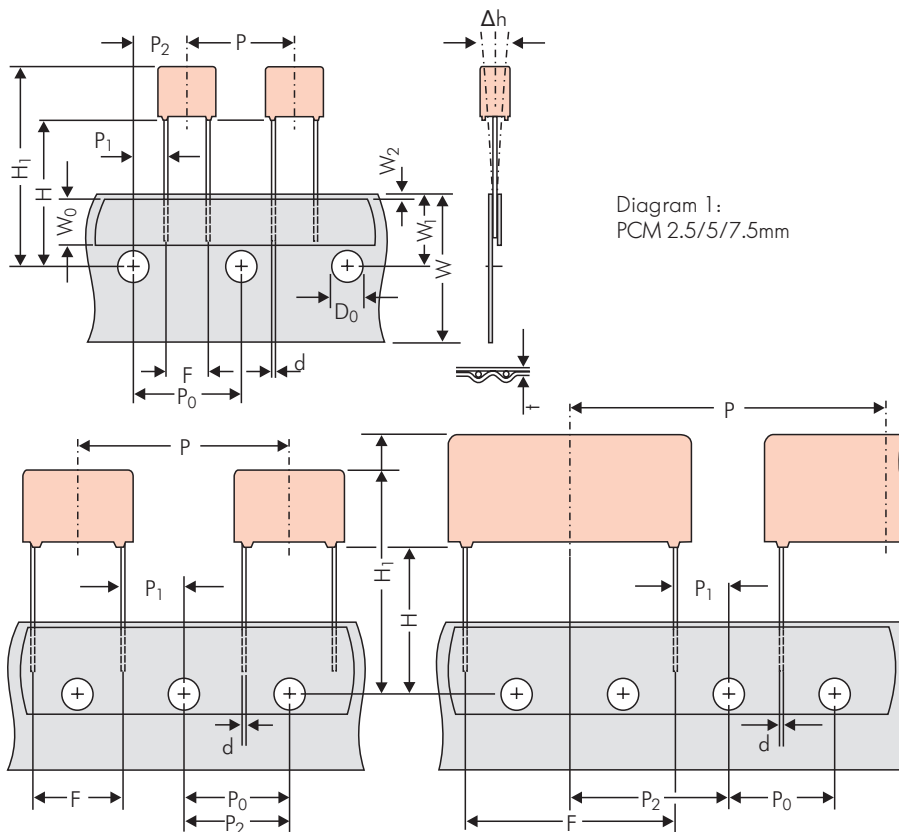

Diagram 2: PCM 10/15 mm

Diagram 3: PCM 22.5 and 27.5*mm

*PCM 27.5 taping possible with two feed holes between components

Designation	Symbol	Dimensions for radial taping							
		PCM 2.5 taping	PCM 5 taping	PCM 7.5 taping	PCM 10 taping*	PCM 15 taping*	PCM 22.5 taping	PCM 27.5 taping	
Carrier tape width	W	18.0 ±0.5	18.0 ±0.5	18.0 ±0.5	18.0 ±0.5	18.0 ±0.5	18.0 ±0.5	18.0 ±0.5	
Hold-down tape width	W ₀	6.0 for hot-sealing adhesive tape	6.0 for hot-sealing adhesive tape	12.0 for hot-sealing adhesive tape	12.0 for hot-sealing adhesive tape	12.0 for hot-sealing adhesive tape	12.0 for hot-sealing adhesive tape	12.0 for hot-sealing adhesive tape	
Hole position	W ₁	9.0 ±0.5	9.0 ±0.5	9.0 ±0.5	9.0 ±0.5	9.0 ±0.5	9.0 ±0.5	9.0 ±0.5	
Hold down tape position	W ₂	0.5 to 3.0 max.	0.5 to 3.0 max.	0.5 to 3.0 max.	0.5 to 3.0 max.	0.5 to 3.0 max.	0.5 to 3.0 max.	0.5 to 3.0 max.	
Feed hole diameter	D ₀	4.0 ±0.2	4.0 ±0.2	4.0 ±0.2	4.0 ±0.2	4.0 ±0.2	4.0 ±0.2	4.0 ±0.2	
Pitch of component	P	12.7 ±1.0	12.7 ±1.0	12.7 ±1.0	25.4 ±1.0	25.4 ±1.0	38.1 ±1.5	38.1 ±1.5 or 50.8 ±1.5	
Feed hole pitch	P ₀	12.7 ±0.3 cumulative pitch error max. 1.0 mm/20 pitch	12.7 ±0.3 cumulative pitch error max. 1.0 mm/20 pitch	12.7 ±0.3 cumulative pitch error max. 1.0 mm/20 pitch	12.7 ±0.3 cumulative pitch error max. 1.0 mm/20 pitch	12.7 ±0.3 cumulative pitch error max. 1.0 mm/20 pitch	12.7 ±0.3 cumulative pitch error max. 1.0 mm/20 pitch	12.7 ±0.3 cumulative pitch error max. 1.0 mm/20 pitch	
Feed hole centre to lead	P ₁	5.1 ±0.5	3.85 ±0.7	2.6 ±0.7	7.7 ±0.7	5.2 ±0.7	7.8 ±0.7	5.3 ±0.7	
Hole centre to component centre	P ₂	6.35 ±1.3	6.35 ±1.3	6.35 ±1.3	12.7 ±1.3	12.7 ±1.3	19.05 ±1.3	19.05 ±1.3	
Feed hole centre to bottom edge of the component	H _▲	16.5 ±0.3 18.5 ±0.5	16.5 ±0.3 18.5 ±0.5	16.5 ±0.5 18.5 ±0.5	16.5 ±0.5 18.5 ±0.5	16.5 ±0.5 18.5 ±0.5	16.5 ±0.5 18.5 ±0.5	16.5 ±0.5 18.5 ±0.5	
Feed hole centre to top edge of component	H ₁	H+H _{component} < H ₁ 32.25 max.	H+H _{component} < H ₁ 32.25 max.	H+H _{component} < H ₁ 24.5 to 31.5	H+H _{component} < H ₁ 25.0 to 31.5	H+H _{component} < H ₁ 26.0 to 37.0	H+H _{component} < H ₁ 30.0 to 43.0	H+H _{component} < H ₁ 35.0 to 45.0	
Lead spacing at upper edge of carrier tape	F	2.5 ±0.5	5.0 ^{+0.8} _{-0.2}	7.5 ±0.8	10.0 ±0.8	15 ±0.8	22.5 ±0.8	27.5 ±0.8	
Lead diameter	d	0.4 ±0.05	0.5 ±0.05	•0.5 ±0.05 or 0.7 ^{+0.07} _{-0.05}	•0.5 ±0.05 or 0.7 ^{+0.07} _{-0.05}	0.8 ^{+0.08} _{-0.05}	0.8 ^{+0.08} _{-0.05}	•0.8 ^{+0.08} _{-0.05} or 1.0 ^{+0.1} _{-0.05}	
Component alignment	Δh	± 2.0 max.	± 2.0 max.	± 3.0 max.	± 3.0 max.	± 3.0 max.	± 3.0 max.	± 3.0 max.	
Total tape thickness	t	0.7 ±0.2	0.7 ±0.2	0.7 ±0.2	0.7 ±0.2	0.7 ±0.2	0.7 ±0.2	0.7 ±0.2	
Package (see also page 15)	▲	ROLL/AMMO			AMMO				
		REEL	REEL	REEL	REEL	REEL	REEL	REEL	REEL
Unit		see details page 93.							

▲ Please give „H“ dimensions and desired packaging type when ordering.

Dims in mm.

• Diameter of leads see General Data.

Please clarify customer-specific deviations with the manufacturer.

* PCM 10 and PCM 15 can be crimped to PCM 7.5.

Position of components according to PCM 7.5 (sketch 1). P₀ = 12.7 or 15.0 is possible.

Gurt-Verpackungsarten für Kondensatoren mit radialen Anschlüssen

Types of tape packaging of capacitors for automatic radial insertion

■ Rollenverpackung ROLL ROLL packaging

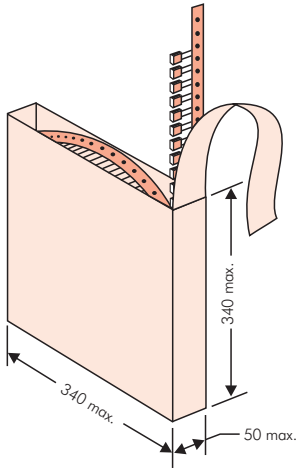

■ Lagenverpackung AMMO AMMO packaging

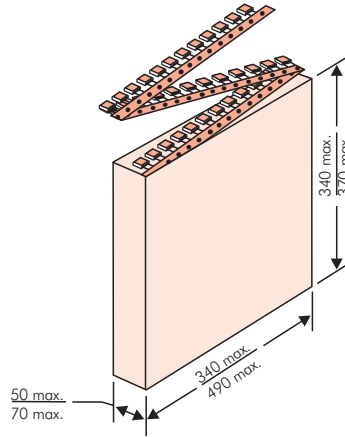

■ Trommelverpackung REEL REEL packaging

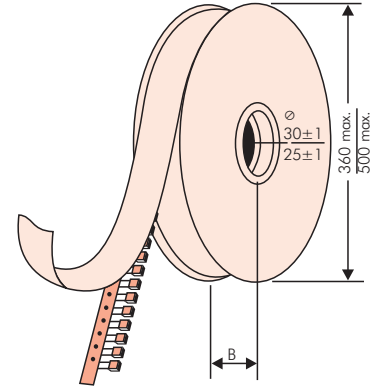

BAR CODE







Etikettierung der Verpackungseinheiten klartextlich und mit alphanumerischem Strichcode

Scanner-Decodierung von

- WIMA-Lieferernummer
- Kunden-Bestellnummer
- Kunden-Sachnummer
- WIMA-Bezeichnung
 - Artikel
 - Kapazitätswert
 - Kapazitätstoleranz
 - Nennspannung
 - Abmessungen
- WIMA-Kommissionsnummer
- Stückzahl

Zusätzlich in Klartext Lieferdatum und Kundenname

BAR CODE „Code 39“

WIMA Kondensatoren/Capacitors		Made in Germany
		Werk Aurich
		26.01.04-30/31
		
Lieferer-Nr. / Supplier No. (W): ...		
		
Bestell-Nr. / P/O No.: ...		
		
MKS-4 (1P) 2.2 µF 20% 100 V- 8 x 15 x 18 RM 15		
		WIMA Kondensatoren
Komm-Nr. / Internal P/O No.: ...		MKS-4 Capacitors
		2.2 µF 20% 100 V-
Sach-Nr. / Part No. (P): ...		8 x 15 x 18 RM 15
		
Menge / Quant. (Q): ...	Kunde / Customer: ...	26.01.04-30/31

Labelling of package units in plain text and with alphanumerical Bar Code

Scanner decoding of

- WIMA supplier number
- Customer's P/O number
- Customer's part number
- WIMA description
 - article
 - capacitance value
 - capacitance tolerance
 - rated voltage
 - dimensions
- WIMA acknowledgement number
- Quantity

In addition date of delivery and customer's name in plain text

Mindeststückzahlen für Schüttware und EPS*

Minimum packing quantities for bulk capacitors and TPS*

Rastermaß/PCM	Bauform/Box size			Stückzahl lose pcs. per packaging unit bulk	Stückzahl/EPS* pcs. per packaging unit/TPS*	MOQ*
	W	H	L			
2.5 mm	2.5	5.5	4.6	1000	-	5000
	2.5	7	4.6	1000	-	5000
	3	7.5	4.6	1000	-	5000
	3.8	8.5	4.6	1000	-	5000
	4.6	9	4.6	1000	-	5000
	5.5	10	4.6	1000	-	5000
5 mm	2.5	5.5	7.2	1000	-	5000
	2.5	6.5	7.2	1000	-	5000
	3	7.5	7.2	1000	-	5000
	3.5	8.5	7.2	1000	-	5000
	4.5	6	7.2	500	-	5000
	4.5	8.5	7.2	500	-	5000
	4.5	9.5	7.2	500	-	5000
	5	9	7.2	500	-	5000
	5	10	7.2	500	-	5000
	5.5	7	7.2	500	-	5000
	5.5	11.5	7.2	500	-	5000
	6.5	8	7.2	500	-	5000
	7.2	8.5	7.2	500	-	5000
	7.2	13	7.2	500	-	5000
	8.5	10	7.2	500	-	5000
8.5	14	7.2	500	-	5000	
7.5 mm	2.5	7	10	1000	-	5000
	3	8.5	10	500	-	5000
	4	9	10	500	-	5000
	4.5	9.5	10.3	500	-	5000
	5	10.5	10.3	500	-	5000
	5.7	12.5	10.3	300	-	5000
10 mm	3	9	13	500	-	2000
	4	8.5	13.5	1000	-	2000
	4	9	13	300	-	2000
	4	9.5	13	300	-	2000
	5	10	13.5	1000	-	2000
	5	11	13	250	-	2000
	6	12	13	200	-	2000
	6	12.5	13	200	-	2000
15 mm	4	10	18	250	-	2000
	5	11	18	200	-	2000
	5	13	19	1000	-	2000
	6	12.5	18	250	-	2000
	6	14	19	1000	-	2000
	7	14	18	200	-	1000
	7	15	19	1000	-	1000
	8	15	18	200	-	1000
	8	17	19	500	-	1000
	9	16	18	150	-	1000
	10	18	19	500	-	1000
22.5 mm	5	14	26.5	-	180	1000
	6	15	26.5	-	155	1000
	7	16.5	26.5	-	130	1000
	8	20	28	-	115	1000
	8.5	18.5	26.5	-	110	1000
	10	22	28	-	90	500
	10.5	19	26.5	-	85	500
	10.5	20.5	26.5	-	85	500
	11	21	26.5	-	85	500
	12	24	28	-	75	500
	27.5 mm	9	19	31.5	-	80
11		21	31.5	-	68	500
13		24	31.5	-	56	500
13		25	33	-	56	500
15		26	31.5	-	48	500
15		26	33	-	48	500
17		29	31.5	-	44	500
17		34.5	31.5	-	44	500
20		32	33	-	36	500
20		39.5	31.5	-	36	500
37.5 mm	9	19	41.5	-	60	500
	11	22	41.5	-	51	500
	13	24	41.5	-	42	500
	15	26	41.5	-	36	500
	17	29	41.5	-	33	500
	19	32	41.5	-	27	500
	20	39.5	41.5	-	27	500
	24	45.5	41.5	-	21	500

Anderungen vorbehalten / Rights reserved to amend design data.

* Einstapel-Paletten-System / Tray-Packing-System

* MOQ = Minimum Order Quantity als ein Vielfaches einer Verpackungseinheit. Muster und Anlaufserien auf Anfrage.

* MOQ = Minimum Order Quantity as a multiple of one packing unit. Samples and pre-production needs on request.

Verpackungseinheiten für gegurtete Kondensatoren mit radialen Anschlüssen

Packing units for taped capacitors with radial leads

Rastermaß/PCM	Bauform/Box size			ROLL	REEL		AMMO		MOQ*
	W	H	L		ø 360	ø 500	340 × 340	490 × 370	
2.5 mm	2.5	5.5	4.6	2200	2500	–	2800	–	5000
	2.5	7	4.6	2200	2500	–	2800	–	5000
	3	7.5	4.6	2000	2300	–	2300	–	5000
	3.8	8.5	4.6	1500	1800	–	1800	–	5000
	4.6	9	4.6	1200	1500	–	1500	–	5000
	5.5	10	4.6	900	1200	–	1200	–	5000
5 mm	2.5	5.5	7.2	2200	2500	–	2800	–	5000
	2.5	6.5	7.2	2200	2500	–	2800	–	5000
	3	7.5	7.2	2000	2300	–	2300	–	5000
	3.5	8.5	7.2	1600	2000	–	2000	–	5000
	4.5	6	7.2	1300	1500	–	1500	–	5000
	4.5	8.5	7.2	1300	1500	–	1500	–	5000
	4.5	9.5	7.2	1300	1500	–	1500	–	5000
	5	9	7.2	1100	1400	–	1400	–	5000
	5	10	7.2	1100	1400	–	1400	–	5000
	5.5	7	7.2	1000	1200	–	1200	–	5000
	5.5	11.5	7.2	1000	1200	–	1200	–	5000
	6.5	8	7.2	800	1000	–	1000	–	5000
	7.2	8.5	7.2	700	1000	–	1000	–	5000
	7.2	13	7.2	700	950	–	1000	–	5000
	8.5	10	7.2	600	800	–	800	–	5000
8.5	14	7.2	600	800	–	800	–	5000	
7.5 mm	2.5	7	10	–	2500	4400	2500	–	5000
	3	8.5	10	–	2200	4300	2300	4150	5000
	4	9	10	–	1700	3200	1700	3100	5000
	4.5	9.5	10.3	–	1500	2900	1400	2800	5000
	5	10.5	10.3	–	1300	2500	1300	–	5000
	5.7	12.5	10.3	–	1000	2200	1100	–	5000
10 mm	3	9	13	–	1100	2200	–	1950	2000
	4	8.5	13.5	–	900	1600	–	1450	2000
	4	9	13	–	900	1600	–	1450	2000
	4	9.5	13	–	900	1600	–	1450	2000
	5	10	13.5	–	700	1300	–	1200	2000
	5	11	13	–	700	1300	–	1200	2000
	6	12	13	–	550	1100	–	1000	2000
	6	12.5	13	–	550	1100	–	1000	2000
15 mm	4	10	18	–	700	1600	–	1500	2000
	5	11	18	–	600	1200	–	1150	2000
	5	13	19	–	600	1200	–	1200	2000
	6	12.5	18	–	500	1000	–	1000	2000
	6	14	19	–	500	1000	–	1000	2000
	7	14	18	–	450	900	–	850	1000
	7	15	19	–	450	900	–	850	1000
	8	15	18	–	400	800	–	740	1000
	8	17	19	–	400	800	–	740	1000
	9	16	18	–	350	700	–	650	1000
10	18	19	–	300	650	–	590	1000	
22.5 mm	5	14	26.5	–	–	800	–	770	1000
	6	15	26.5	–	–	700	–	640	1000
	7	16.5	26.5	–	–	600	–	550	1000
	8	20	28	–	–	500	–	480	1000
	8.5	18.5	26.5	–	–	480	–	450	1000
	10	22	28	–	–	420	–	380	500
	10.5	19	26.5	–	–	400	–	360	500
	10.5	20.5	26.5	–	–	400	–	360	500
	11	21	26.5	–	–	380	–	350	500
12	24	28	–	–	350	–	310	500	
27.5 mm	9	19	31.5	–	–	460/340*	–	420	500
	11	21	31.5	–	–	380/280*	–	350	500
	13	24	31.5	–	–	300	–	290	500
	15	26	31.5	–	–	270	–	250	500

* bei 2-Zoll-Transportschritt / for 2-inch transport pitches.

Änderungen vorbehalten / Rights reserved to amend design data.

* MOQ = Minimum Order Quantity als ein Vielfaches einer Verpackungseinheit. Muster und Anlaufserien 1 Verpackungseinheit minimum.

* MOQ = Minimum Order Quantity as a multiple of one packing unit. Minimum 1 packing unit for samples and pre-production needs.

X-ON Electronics

Largest Supplier of Electrical and Electronic Components

Click to view similar products for [WIMA](#) manufacturer:

Other Similar products are found below :

[FKP1/0.047/20/400](#) [DCP5K05590D000KS00](#) [SMD-PET-KIT1](#) [FKP1U024707E00JSSD](#) [SMDTD03470TB00KQ00](#) [KIT SMD PET 02](#)
[FKP1T031007E00JSSD](#) [DCP5R25160D000KS00](#) [KIT MKS](#) [MKP1F033305B00JSSD](#) [MKP1O141007G00KYSD](#) [FKS3/0.01/10/100](#)
[DCP4P053008AD4KSSD](#) [FKP1T011504D00JSSD](#) [MKP2G014701B00JSSD](#) [MKP1T016804B00JSSD](#) [204220DM](#) [FKP-KIT](#) [KIT FKP](#)
[MKS4C046804F00JF00](#) [FKP2D011001D00ESSD](#) [MKP1F033304F00JSSD](#) [SMDTG03470YA00KT00](#) [DCP4I061009HD2KYSD](#)
[FKP1U011004D00KSSD](#) [MKP1G032204J00MSSD](#) [MKP1J041006G00JSSD](#) [MPY20W2220FE00MSSD](#) [MKS4C046804F00KSSD](#)
[MKS2C024701A00JF00](#) [MKP4F046806G00JSSD](#) [MKP4F041505G00JYSD](#) [GTOMS04400GB00MS00](#) [FKP2J021001L00HI00](#)
[GTOMS04800GD00MS00](#) [DCP6R26250E100KS0F](#) [MKP2D024701C00JO00](#) [MKP4O121002F00KSSD](#) [SNMPO145008LD4KSSD](#)
[MKP4D053307H00KSSD](#) [DCP5R25400D100KS00](#) [MKS4C034703C00KSSD](#) [WWK-101](#) [MKS-KIT](#) [GTOMS04350GA00MS00](#)
[GTOMS04300GA00KS00](#) [SMDTC03470QA00KP00](#) [DCP4L051506JD2KYSD](#) [MKP4-.68/400/5P22](#) [MKS4C046805D00JSSD](#)